

## “Full Bridge” IGBT MTP (Warp Speed IGBT), 50 A



MTP

PRIMARY CHARACTERISTICS	
$V_{CES}$	600 V
$I_C$ DC	69 A
$V_{CE(on)}$	2.22 V
Speed	8 kHz to 30 kHz
Package	MTP
Circuit configuration	Full bridge

### FEATURES

- Gen 4 warp speed IGBT technology
- HEXFRED® antiparallel diodes with ultrasoft reverse recovery
- Very low conduction and switching losses
- Optional SMT thermistor
- $Al_2O_3$  DBC
- Very low stray inductance design for high speed operation
- Speed 8 kHz to 30 kHz > 20 kHz hard switching, > 200 kHz resonant mode
- UL approved file E78996 
- Designed and qualified for industrial level
- Material categorization: for definitions of compliance please see [www.vishay.com/doc?99912](http://www.vishay.com/doc?99912)

**RoHS**  
COMPLIANT

### BENEFITS

- Optimized for welding, UPS and SMPS applications
- Low EMI, requires less snubbing
- Direct mounting to heatsink
- PCB solderable terminals
- Very low junction to case thermal resistance

ABSOLUTE MAXIMUM RATINGS				
PARAMETER	SYMBOL	TEST CONDITIONS	MAX.	UNITS
Collector to emitter voltage	$V_{CES}$		600	V
Continuous collector current	$I_C$	$T_C = 25\text{ }^\circ\text{C}$	69	A
		$T_C = 80\text{ }^\circ\text{C}$	46	
Pulsed collector current	$I_{CM}$		200	
Peak switching current	$I_{LM}$		200	
Diode continuous forward current	$I_F$	$T_C = 100\text{ }^\circ\text{C}$	25	
Peak diode forward current	$I_{FM}$		200	
Gate to emitter voltage	$V_{GE}$		$\pm 20$	
RMS isolation voltage	$V_{ISOL}$	Any terminal to case, t = 1 minute	2500	
Maximum power dissipation per single IGBT	$P_D$	$T_C = 25\text{ }^\circ\text{C}$	195	W
		$T_C = 100\text{ }^\circ\text{C}$	78	



ELECTRICAL SPECIFICATIONS (T <sub>J</sub> = 25 °C unless otherwise noted)						
PARAMETER	SYMBOL	TEST CONDITIONS	MIN.	TYP.	MAX.	UNITS
Collector to emitter breakdown voltage	V <sub>(BR)CES</sub>	V <sub>GE</sub> = 0 V, I <sub>C</sub> = 250 μA	600	-	-	V
Temperature coefficient of breakdown voltage	ΔV <sub>(BR)CES</sub> /ΔT <sub>J</sub>	V <sub>GE</sub> = 0 V, I <sub>C</sub> = 4 mA (25 °C to 125 °C)	-	+0.6	-	V/°C
Collector to emitter saturation voltage	V <sub>CE(on)</sub>	V <sub>GE</sub> = 15 V, I <sub>C</sub> = 25 A	-	2.22	3.14	V
		V <sub>GE</sub> = 15 V, I <sub>C</sub> = 50 A	-	2.43	3.25	
		V <sub>GE</sub> = 15 V, I <sub>C</sub> = 25 A, T <sub>J</sub> = 150 °C	-	1.65	1.93	
		V <sub>GE</sub> = 15 V, I <sub>C</sub> = 50 A, T <sub>J</sub> = 150 °C	-	2.08	2.45	
Gate threshold voltage	V <sub>GE(th)</sub>	V <sub>CE</sub> = V <sub>GE</sub> , I <sub>C</sub> = 250 μA	3	-	6	
Temperature coefficient of threshold voltage	ΔV <sub>GE(th)</sub> /ΔT <sub>J</sub>	V <sub>CE</sub> = V <sub>GE</sub> , I <sub>C</sub> = 250 μA (25 °C to 125 °C)	-	-17	-	mV/°C
Transconductance	g <sub>fe</sub>	V <sub>CE</sub> = 100 V, I <sub>C</sub> = 25 A, PW = 80 μs	-	43	-	S
Zero gate voltage collector current	I <sub>CES</sub> (1)	V <sub>GE</sub> = 0 V, V <sub>CE</sub> = 600 V, T <sub>J</sub> = 25 °C	-	-	250	μA
		V <sub>GE</sub> = 0 V, V <sub>CE</sub> = 600 V, T <sub>J</sub> = 150 °C	-	-	10	mA
Gate to emitter leakage current	I <sub>GES</sub>	V <sub>GE</sub> = ± 20 V	-	-	± 250	nA
Diode forward voltage drop	V <sub>FM</sub>	I <sub>C</sub> = 25 A	-	1.36	1.64	V
		I <sub>C</sub> = 50 A	-	1.57	1.93	
		I <sub>C</sub> = 25 A; T <sub>J</sub> = 150 °C	-	1.19	1.42	
		I <sub>C</sub> = 50 A; T <sub>J</sub> = 150 °C	-	1.48	1.80	

**Note**

(1) I<sub>CES</sub> includes also opposite leg overall leakage

SWITCHING CHARACTERISTICS (T <sub>J</sub> = 25 °C unless otherwise specified)						
PARAMETER	SYMBOL	TEST CONDITIONS	MIN.	TYP.	MAX.	UNITS
Total gate charge (turn-on)	Q <sub>g</sub>	I <sub>C</sub> = 25 A V <sub>CC</sub> = 480 V V <sub>GE</sub> = 15 V	-	175	263	nC
Gate to emitter charge (turn-on)	Q <sub>ge</sub>		-	27	41	
Gate to collector charge (turn-on)	Q <sub>gc</sub>		-	71	107	
Turn-on switching loss	E <sub>on</sub>	R <sub>g</sub> = 5 Ω, I <sub>C</sub> = 25 A V <sub>CC</sub> = 480 V V <sub>GE</sub> = ± 15 V, T <sub>J</sub> = 25 °C	-	0.13	0.20	mJ
Turn-off switching loss	E <sub>off</sub>		-	0.42	0.62	
Total switching loss	E <sub>tot</sub>		-	0.55	0.82	
Turn-on switching loss	E <sub>on</sub>		R <sub>g</sub> = 5 Ω, I <sub>C</sub> = 25 A V <sub>CC</sub> = 480 V V <sub>GE</sub> = ± 15 V, T <sub>J</sub> = 125 °C	-	0.39	
Turn-off switching loss	E <sub>off</sub>	-		0.49	0.74	
Total switching loss	E <sub>tot</sub>	-		0.88	1.32	
Input capacitance	C <sub>ies</sub>	V <sub>GE</sub> = 0 V V <sub>CC</sub> = 30 V f = 1.0 MHz		-	3610	5415
Output capacitance	C <sub>oes</sub>		-	714	1071	
Reverse transfer capacitance	C <sub>res</sub>		-	58	87	
Diode reverse recovery time	t <sub>rr</sub>	V <sub>R</sub> = 200 V; I <sub>C</sub> = 25 A; di/dt = 200 A/μs	-	50	-	ns
Diode peak reverse current	I <sub>rr</sub>		-	4.5	-	A
Diode Recovery charge	Q <sub>rr</sub>		-	112	-	nC
Diode peak rate of fall of recovery during t <sub>b</sub>	di <sub>(rec)</sub> /dt		-	250	-	A/μs

**THERMAL AND MECHANICAL SPECIFICATIONS**

PARAMETER	SYMBOL	TEST CONDITIONS	MIN.	TYP.	MAX.	UNITS
Operating junction temperature range	T <sub>J</sub>		-40	-	150	°C
Storage temperature range	T <sub>Stg</sub>		-40	-	125	
Junction to case	IGBT	R <sub>thJC</sub>	-	-	0.64	°C/W
	Diode		-	-	0.9	
Case to sink per module	R <sub>thCS</sub>	Heatsink compound thermal conductivity = 1 W/mK	-	0.06	-	
Clearance (1)		External shortest distance in air between 2 terminals	5.5	-	-	mm
Creepage (1)		Shortest distance along external surface of the insulating material between 2 terminals	8	-	-	
Weight				66		g

**Note**

(1) Standard version only i.e. without optional thermistor

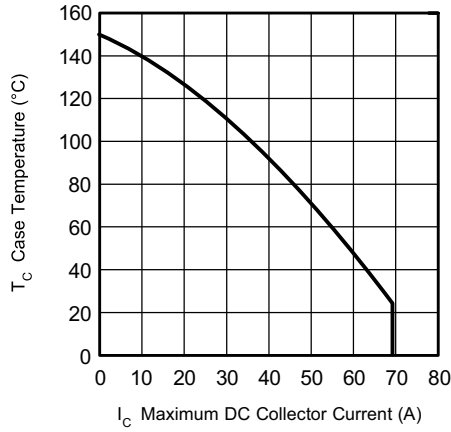

Fig. 1 - Maximum Collector Current vs. Case Temperature

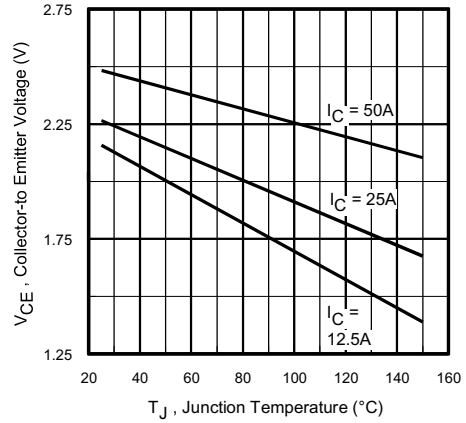

Fig. 2 - Typical Collector to Emitter Voltage vs. Junction Temperature

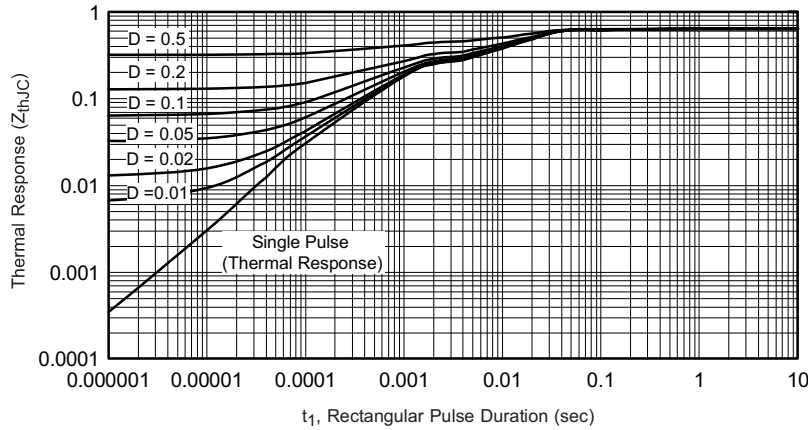

Fig. 3 - Maximum Transient Thermal Impedance, Junction to Case (IGBT)

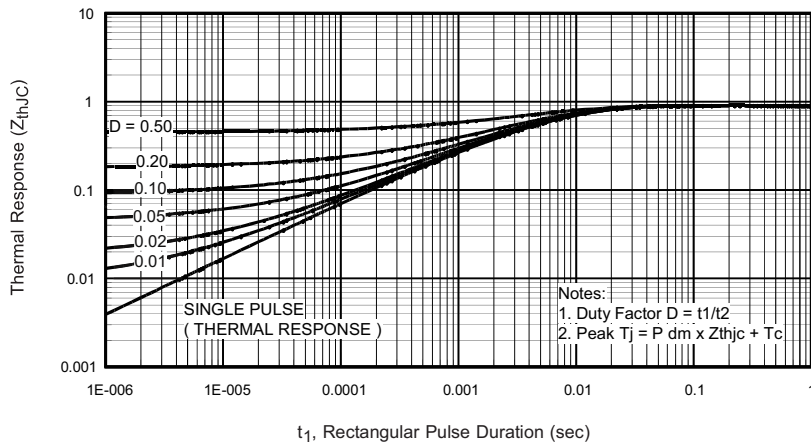

Fig. 4 - Maximum Transient Thermal Impedance, Junction to Case (Diode)

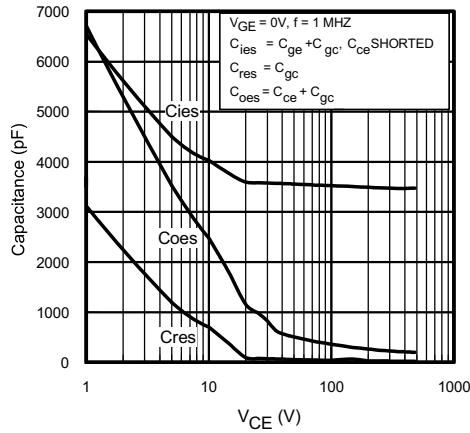

Fig. 5 - Typical Capacitance vs. Collector to Emitter Voltage

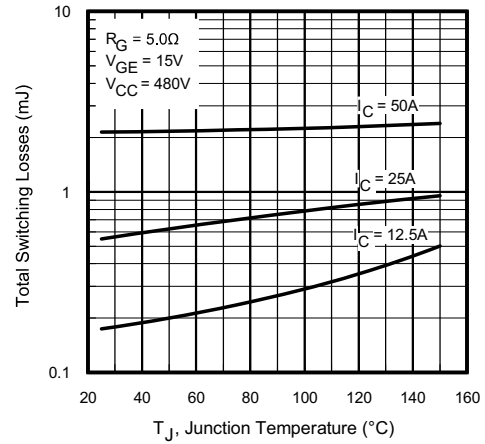

Fig. 8 - Typical Switching Losses vs. Junction Temperature

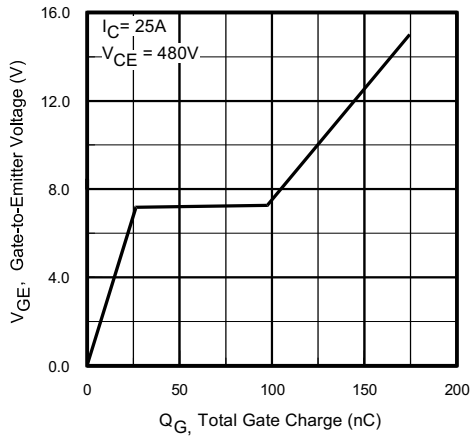

Fig. 6 - Typical Gate Charge vs. Gate to Emitter Voltage

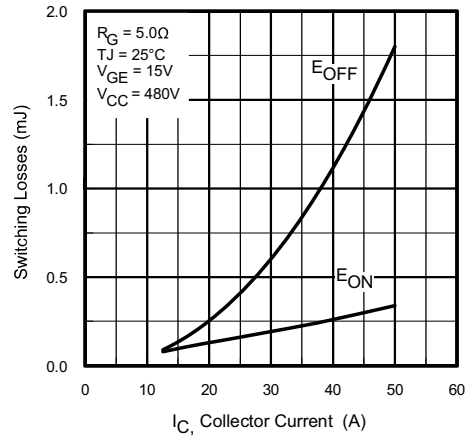

Fig. 9 - Typical Switching Losses vs. Collector to Emitter Current

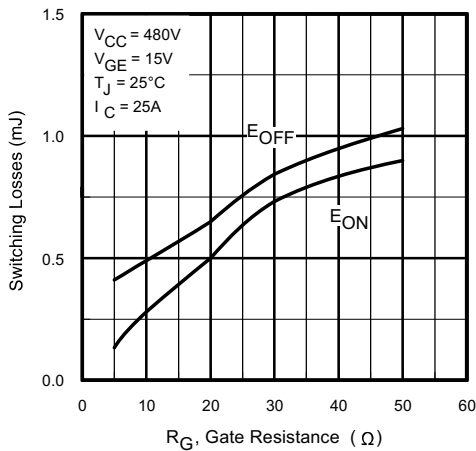

Fig. 7 - Typical Switching Losses vs. Gate Resistance

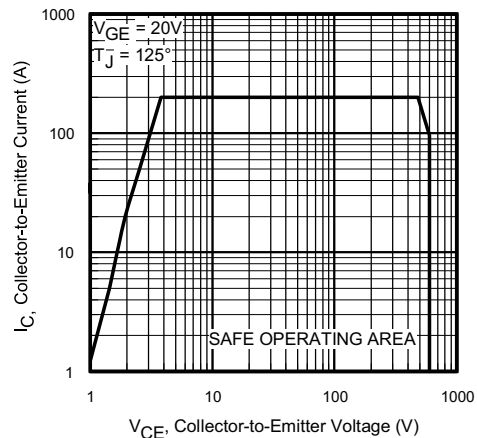

Fig. 10 - Turn-Off SOA

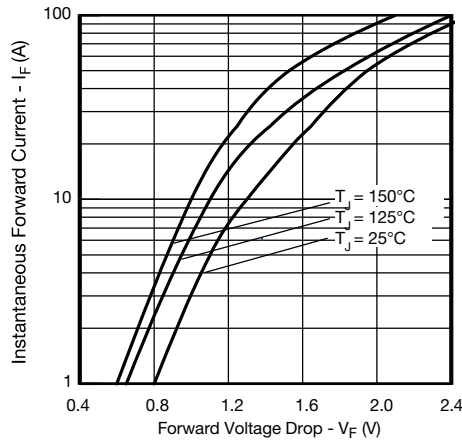

Fig. 11 - Maximum Forward Voltage Drop vs. Instantaneous Forward Current

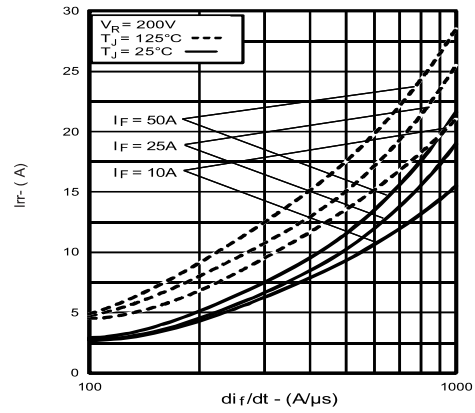

Fig. 13 - Typical Reverse Recovery Current vs.  $di_F/dt$

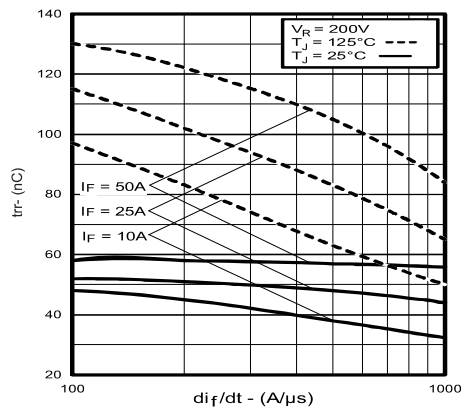

Fig. 12 - Typical Reverse Recovery Time vs.  $di_F/dt$

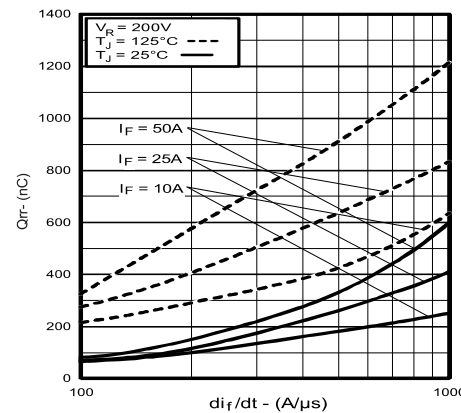

Fig. 14 - Typical Stored Charge vs.  $di_F/dt$

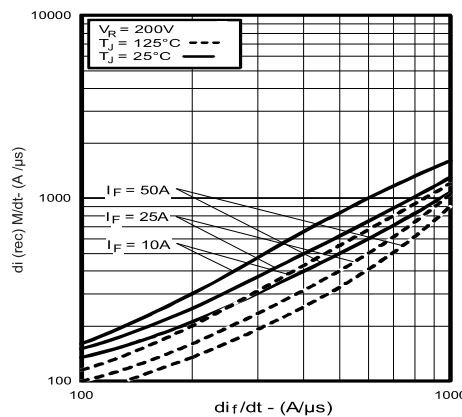

Fig. 15 - Typical  $di_{(rec)M}/dt$  vs.  $di_F/dt$

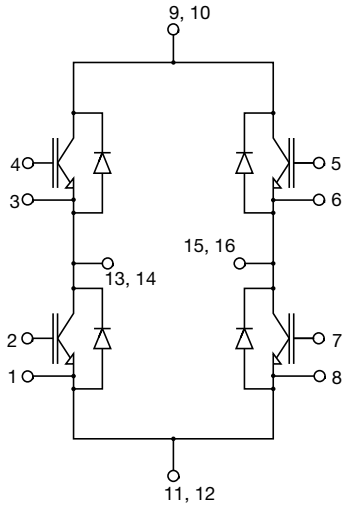

Fig. 16 - Electrical diagram

**ORDERING INFORMATION TABLE**

Device code	<b>VS-</b>	<b>25</b>	<b>MT</b>	<b>060</b>	<b>W</b>	<b>F</b>	<b>A</b>	<b>PbF</b>
	①	②	③	④	⑤	⑥	⑦	⑧

- 1** - Vishay Semiconductors product
- 2** - Current rating (25 = 25 A)
- 3** - Essential part number
- 4** - Voltage code (060 = 600 V)
- 5** - Speed / type (W = warp IGBT)
- 6** - Circuit configuration (F = full bridge)
- 7** - A = Al<sub>2</sub>O<sub>3</sub> DBC substrate
- 8** - PbF = lead (Pb)-free

**CIRCUIT CONFIGURATION**

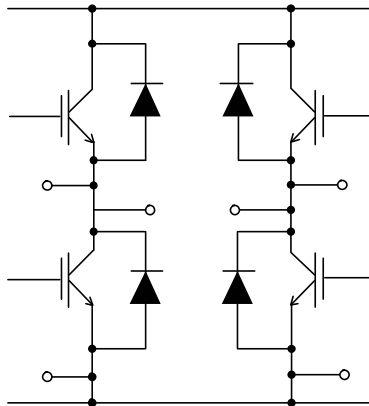

LINKS TO RELATED DOCUMENTS	
Dimensions	<a href="http://www.vishay.com/doc?95245">www.vishay.com/doc?95245</a>

## MTP

**DIMENSIONS** in millimeters

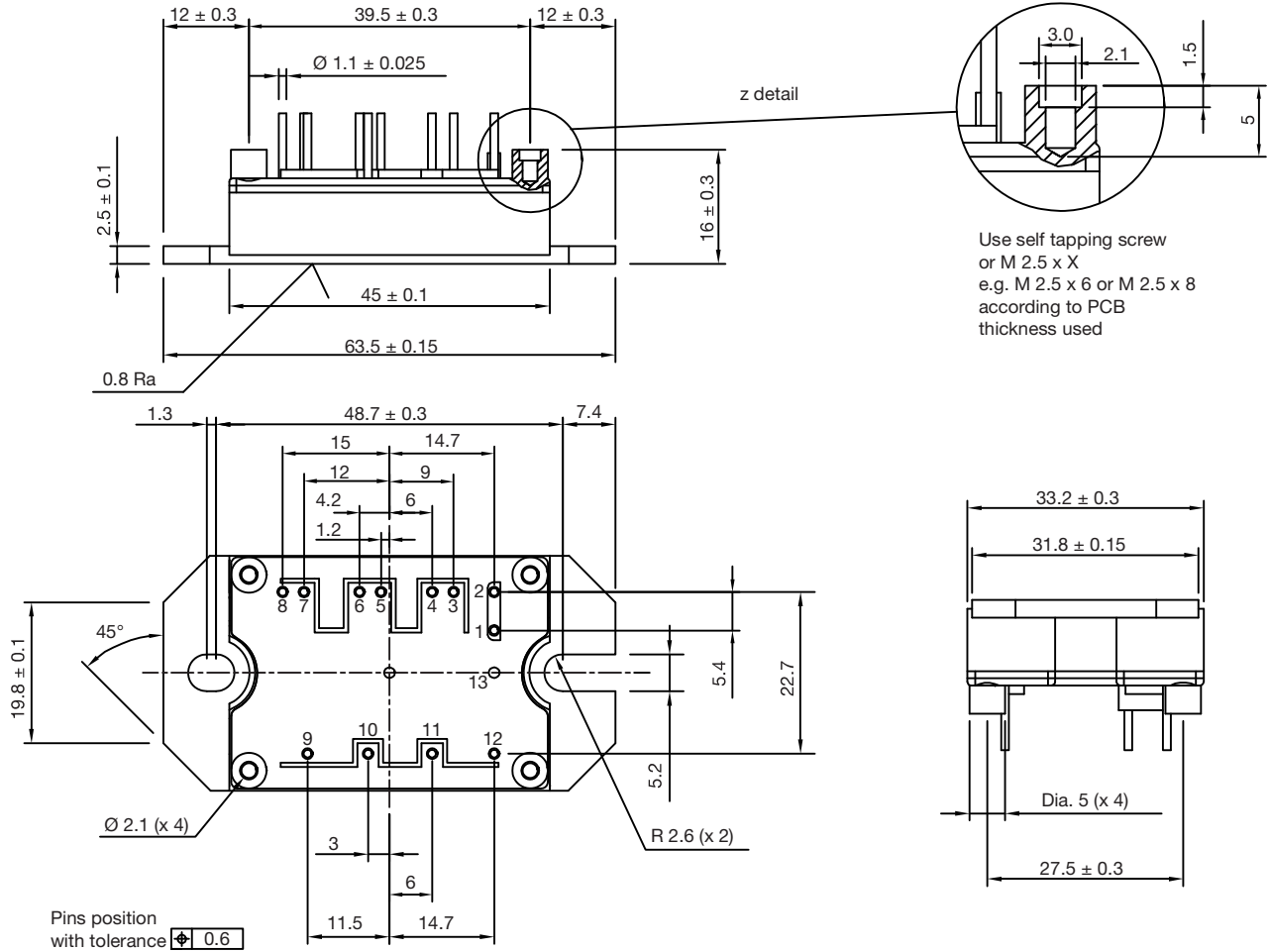

**Note**

- Unused terminals are not assembled in the package



## **Disclaimer**

ALL PRODUCT, PRODUCT SPECIFICATIONS AND DATA ARE SUBJECT TO CHANGE WITHOUT NOTICE TO IMPROVE RELIABILITY, FUNCTION OR DESIGN OR OTHERWISE.

Vishay Intertechnology, Inc., its affiliates, agents, and employees, and all persons acting on its or their behalf (collectively, "Vishay"), disclaim any and all liability for any errors, inaccuracies or incompleteness contained in any datasheet or in any other disclosure relating to any product.

Vishay makes no warranty, representation or guarantee regarding the suitability of the products for any particular purpose or the continuing production of any product. To the maximum extent permitted by applicable law, Vishay disclaims (i) any and all liability arising out of the application or use of any product, (ii) any and all liability, including without limitation special, consequential or incidental damages, and (iii) any and all implied warranties, including warranties of fitness for particular purpose, non-infringement and merchantability.

Statements regarding the suitability of products for certain types of applications are based on Vishay's knowledge of typical requirements that are often placed on Vishay products in generic applications. Such statements are not binding statements about the suitability of products for a particular application. It is the customer's responsibility to validate that a particular product with the properties described in the product specification is suitable for use in a particular application. Parameters provided in datasheets and / or specifications may vary in different applications and performance may vary over time. All operating parameters, including typical parameters, must be validated for each customer application by the customer's technical experts. Product specifications do not expand or otherwise modify Vishay's terms and conditions of purchase, including but not limited to the warranty expressed therein.

Except as expressly indicated in writing, Vishay products are not designed for use in medical, life-saving, or life-sustaining applications or for any other application in which the failure of the Vishay product could result in personal injury or death. Customers using or selling Vishay products not expressly indicated for use in such applications do so at their own risk. Please contact authorized Vishay personnel to obtain written terms and conditions regarding products designed for such applications.

No license, express or implied, by estoppel or otherwise, to any intellectual property rights is granted by this document or by any conduct of Vishay. Product names and markings noted herein may be trademarks of their respective owners.