

# FEMALE PLUG M8 90° ANGLED TO MALE PLUG M8 STRAIGHT WSOR CABLES

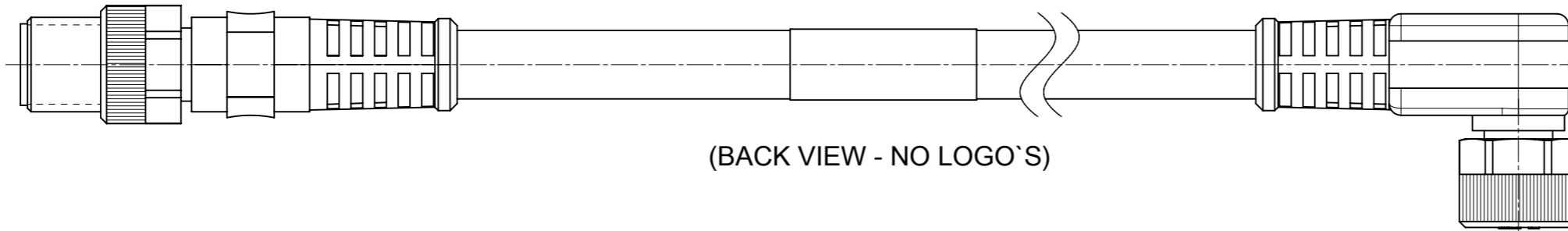
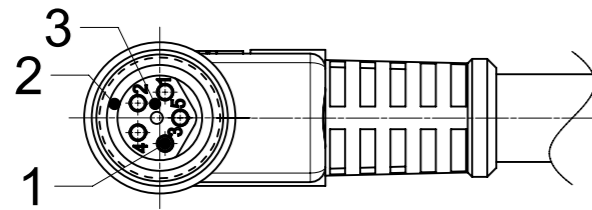
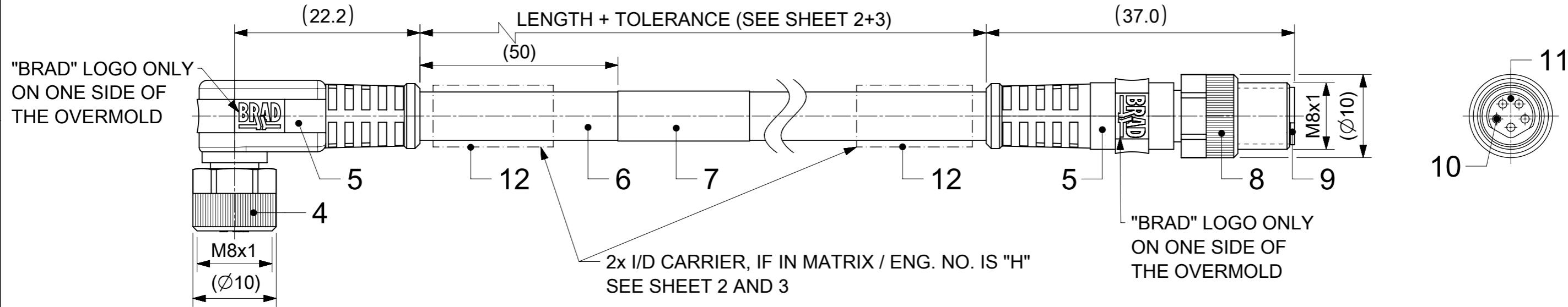

- NOTES:
- PRODUCT SPECIFICATION:  
 RATED VOLTAGE: 3 contacts 60V AC/DC  
 4 and 5 contacts 30V AC/DC  
 CURRENT RATING: 3, 4, 5 contacts 3A  
 PROTECTION CLASS: IP 67  
 TEMPERATURE: -25°C / +80°C
  - PACKAGING: THE CORDSETS ARE PACKED IN PLASTIC BAGS AND DELIVERED IN CARTON BOXES
  - SAFETY: INSTALLATION, MOUNTING, AND MAINTENANCE OF THE PRODUCT MAY ONLY BE CARRIED OUT BY A QUALIFIED ELECTRICIAN

## CONTACT POSITION FRONT VIEW:

	3 CONTACTS - AC		4 CONTACTS - AC		5 CONTACTS - BC	
FEMALE						
MALE						
CONNECTIONS	PIN	WIRE	PIN	WIRE	PIN	WIRE
	1	BROWN	1	BROWN	1	BROWN
	3	BLUE	2	WHITE	2	WHITE
	4	BLACK	3	BLUE	3	BLUE
			4	BLACK	4	BLACK
					5	GREY

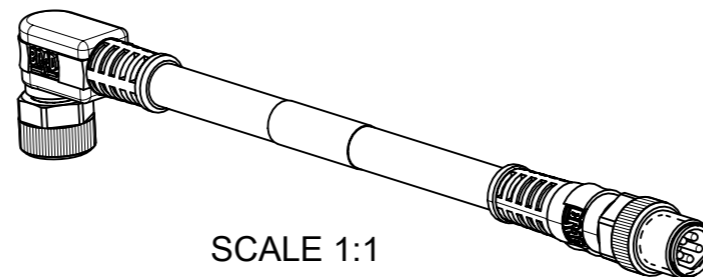

## FOR OPTIONS SEE - NUMERICAL CODE - ON SHEET 2

ITEM	QTY.	DESCRIPTION	MATERIAL	FINISH
12	2	I/D CARRIER	PVC	---
11	1	INSERT MALE BLACK	TPU	---
10	3 / 4 / 5	CONTACT M8 MALE	BRASS	SELECTIVE Au OVER Ni
9	1	SLEEVE	BRASS	NICKEL
8	1	COUPLING NUT M8 MALE SW9	BRASS	NICKEL
7	1	LABEL YELLOW	VINYL	---
6	-	CABLE	SEE SHEET 2	---
5	-	OVERMOLD BLACK	TPU	---
4	1	COUPLING NUT M8 FEMALE SW9	BRASS	NICKEL
3	1	INSERT FEMALE BLACK	TPU	---
2	1	O-RING RED	FKM	---
1	3 / 4 / 5	CONTACT M8 FEMALE	BRASS	SELECTIVE Au OVER Ni
ITEM	QTY.	DESCRIPTION	MATERIAL	FINISH

SYMBOLS		THIS DRAWING CONTAINS INFORMATION THAT IS PROPRIETARY TO MOLEX ELECTRONIC TECHNOLOGIES, LLC AND SHOULD NOT BE USED WITHOUT WRITTEN PERMISSION			
▽ = 0	mm	SCALE	2:1		
▽ = 0	GENERAL TOLERANCES (UNLESS SPECIFIED)		EC NO: 742953		CSE M8 M8 XP XC FE RA WSOR MA STR XM PRODUCT CUSTOMER DRAWING
▽ = 0	ANGULAR TOL ± 1.0°		DRWN: RSCHIEBER 2023/03/20		
▽ = 0	4 PLACES ±		CHK'D: RSILLER 2023/03/20		
▽ = 0	3 PLACES ±		APPR: RSILLER 2023/03/20		DOCUMENT NUMBER <b>1200878734</b>
▽ = 0	2 PLACES ± 0.05		INITIAL REVISION:		
▽ = 0	1 PLACE ± 0.3		DRWN: RSCHIEBER 2018/09/24		DOC TYPE DOC PART REVISION PSD 000 A4
▽ = 0	0 PLACES ± 0.5		APPR: RSILLER 2018/12/10		
■ = 0	DRAFT WHERE APPLICABLE MUST REMAIN WITHIN DIMENSIONS		THIRD ANGLE PROJECTION	DRAWING	SERIES
▽ = 0				A3-SIZE	120087
		MATERIAL NUMBER		CUSTOMER	
		SEE SHEET 3		GENERAL MARKET	
		SHEET NUMBER		1 OF 3	

CODING ACCORDING TO IEC 61076-2-104

DOCUMENT STATUS	P1	RELEASE DATE	2023/03/20	16:44:59
-----------------	----	--------------	------------	----------

ENGINEERING NO. - NUMERICAL CODE (Available parts see PART LIST table. Other parts available upon request).

OPTIONS

4 4 X 0 3 1 B X X X X X X X

44=Nano-Change  
M8x1  
Double ended

Poles:  
3=3 Contacts  
4=4 Contacts  
5=5 Contacts

Heads style:  
031=Plug Female 90°  
to Plug Male Straight

Cable type: See Table

Units:  
M=Meter  
C=Centimeter

Length  
Examples:  
005=0.5 unit  
010=1 unit  
100=10 unit

Overmold color:  
Blank (Standard)=Black

H= 2 pcs. of  
I/D Carrier PVC Transparent

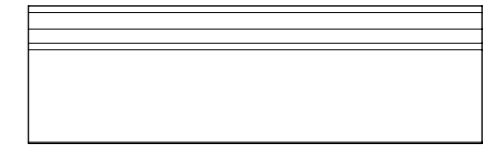
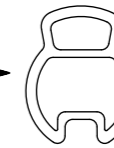

CABLE INFORMATION (for more information see Cable Data Sheet)

CABLE TYPE	NO. OF WIRES	CROSS SECTION	CABLE JACKET	UL	CSA	STATIC: TEMP. / BENDING RADIUS	DYNAMIC: TEMP. / BENDING RADIUS	DRAG CHAIN: TEMP. / BENDING RADIUS	DRAG CHAIN	CABLE PRODUCT SPECIFICATION	CABLE SPEC. DRAWING
B41	3 / 4 / 5	0.25mm <sup>2</sup>	TPU Black	UL 21215/758	C22.2 I/II A/B 80°/600V	-40°C to +90°C 5xO.D.	-25°C to +80°C 7.5xO.D.	-5°C to +60°C 7.5xO.D.	up to 5 000 000 cycles at temp 20°C	1552200001	SD-120209-001

CABLE LENGTH TOLERANCES

LENGTH	TOLERANCE
0m-1m	+40 mm
>1m-5m	+60 mm
>5m-10m	+80 mm
>10m-20m	+140 mm
>20m-30m	+160 mm
>30m	+1% length

SYMBOLS	THIS DRAWING CONTAINS INFORMATION THAT IS PROPRIETARY TO MOLEX ELECTRONIC TECHNOLOGIES, LLC AND SHOULD NOT BE USED WITHOUT WRITTEN PERMISSION	
	DIMENSION UNITS	SCALE
▽ = 0	mm	2:1
▽ = 0	GENERAL TOLERANCES (UNLESS SPECIFIED)	
▽ = 0	ANGULAR TOL ± 1.0°	
▽ = 0	4 PLACES ±	CURRENT REV DESC: NEW LENGTHS ADDED
▽ = 0	3 PLACES ±	
▽ = 0	2 PLACES ± 0.05	EC NO: 742953 DRWN: RSCHIEBER 2023/03/20 CHK'D: RSILLER 2023/03/20 APPR: RSILLER 2023/03/20
▽ = 0	1 PLACE ± 0.3	
▽ = 0	0 PLACES ± 0.5	INITIAL REVISION: DRWN: RSCHIEBER 2018/09/24 APPR: RSILLER 2018/12/10
□ = 0	DRAFT WHERE APPLICABLE MUST REMAIN WITHIN DIMENSIONS	
▽ = 0	THIRD ANGLE PROJECTION	DRAWING
		A3-SIZE
	SERIES	120087
	MATERIAL NUMBER	SEE SHEET 3
	CUSTOMER	GENERAL MARKET
	DOCUMENT NUMBER	1200878734
	DOC TYPE	PSD
	DOC PART	000
	REVISION	A4
	SHEET NUMBER	2 OF 3

**molex**

CSE M8 M8 XP XC FE RA WSOR MA STR XM

PRODUCT CUSTOMER DRAWING

PART LIST

No.	Molex PN.	Engineering No.	Cable Length
1	1200878721	443031B41M006	0.6m
2	1200878722	443031B41M010	1m
3	1200878723	443031B41M020	2m
4	1200879091	443031B41M025	2.5m
5	1200878724	443031B41M030	3m
6	1200879092	443031B41M040	4m
7	1200878725	443031B41M050	5m
8	1200878726	443031B41M100	10m
9	1200878727	444031B41M006	0.6m
10	1200878728	444031B41M010	1m
11	1200878729	444031B41M020	2m
12	1200878730	444031B41M030	3m
13	1200878731	444031B41M050	5m
14	1200878732	444031B41M100	10m
15	1200878733	445031B41M006	0.6m
16	1200878734	445031B41M010	1m
17	1200878735	445031B41M020	2m
18	1200878736	445031B41M030	3m
19	1200878737	445031B41M050	5m
20	1200878738	445031B41M100	10m
21	1200878861	443031B41M005H	0.5m
22	1200878862	443031B41M010H	1m
23	1200878863	443031B41M020H	2m
24	1200878864	443031B41M030H	3m
25	1200878865	443031B41M050H	5m
26	1200878866	443031B41M100H	10m
27	1200878867	443031B41M150H	15m
28	1200878909	443031B41M200H	20m
29	1200878910	443031B41M250H	25m
30	1200878957	443031B41M015	1.5m
31	1200879042	444031B41M040	4m
32	1200879043	444031B41M080	8m
33			
34			
35			

No.	Molex PN.	Engineering No.	Cable Length
36			
37			
38			
39			
40			
41			
42			
43			
44			
45			
46			
47			
48			
49			
50			
51			
52			
53			
54			
55			
56			
57			
58			
59			
60			
61			
62			
63			
64			
65			
66			
67			
68			
69			
70			

No.	Molex PN.	Engineering No.	Cable Length
71			
72			
73			
74			
75			
76			
77			
78			
79			
80			
81			
82			
83			
84			
85			
86			
87			
88			
89			
90			
91			
92			
93			
94			
95			
96			
97			
98			
99			
100			
101			
102			
103			
104			
105			

No.	Molex PN.	Engineering No.	Cable Length
106			
107			
108			
109			
110			
111			
112			
113			
114			
115			
116			
117			
118			
119			
120			
121			
122			
123			
124			
125			
126			
127			
128			
129			
130			
131			
132			
133			
134			
135			
136			
137			
138			
139			
140			

<b>SYMBOLS</b> ▽ = 0 ▽ = 0 ▽ = 0 ▽ = 0 ▽ = 0 ▽ = 0 ▽ = 0 ▽ = 0 ▽ = 0 ▽ = 0 ▽ = 0	THIS DRAWING CONTAINS INFORMATION THAT IS PROPRIETARY TO MOLEX ELECTRONIC TECHNOLOGIES, LLC AND SHOULD NOT BE USED WITHOUT WRITTEN PERMISSION		DIMENSION UNITS: <b>mm</b>		SCALE: <b>2:1</b>		CURRENT REV DESC: NEW LENGTHS ADDED		 CSE M8 M8 XP XC FE RA WSOR MA STR XM						
	GENERAL TOLERANCES (UNLESS SPECIFIED)		ANGULAR TOL ± 1.0°		EC NO: 742953		DRWN: RSCHIEBER 2023/03/20 CHK'D: RSILLER 2023/03/20 APPR: RSILLER 2023/03/20						PRODUCT CUSTOMER DRAWING		
	4 PLACES ±		3 PLACES ±		2 PLACES ± 0.05		INITIAL REVISION:		DRWN: RSCHIEBER 2018/09/24 APPR: RSILLER 2018/12/10		DOCUMENT NUMBER: <b>1200878734</b>		DOC TYPE: PSD	DOC PART: 000	REVISION: <b>A4</b>
	1 PLACE ± 0.3		0 PLACES ± 0.5		DRAFT WHERE APPLICABLE MUST REMAIN WITHIN DIMENSIONS		THIRD ANGLE PROJECTION		DRAWING: <b>A3-SIZE</b>	SERIES: <b>120087</b>	MATERIAL NUMBER: SEE SHEET 3		CUSTOMER: GENERAL MARKET		SHEET NUMBER: 3 OF 3
	DOCUMENT STATUS: P1   RELEASE DATE: 2023/03/20 16:44:59														