

Evaluation kit for EiceDRIVER™ 1EDN7550B single-channel low- side non-isolated gate driver IC with truly differential inputs

KIT_DRIVER_1EDN7550B

Vincent Chi Zhang (IFAT PMM ACDC AE)
Menditti Matrisciano Carmen (IFAT PMM ACDC AE)
Florian Zechner (IFAT PMM ACDC AE)



General description

Introduction

This evaluation kit provides a test platform for Infineon's single-channel non-isolated gate driver IC with truly differential inputs EiceDRIVER™ 1EDN7550B in SOT-23 6pin package.

The complete driving circuitry is integrated into the board allowing a simple and practical step-by-step discovery of the 1EDN7550B characteristics and the evaluation of the influence of the surrounding driving circuitry on the signal delivered to the load. The driver is intended to feed a low-side MOSFET in TO-220 package. For this purpose an Infineon CoolMOS™ or OptiMOS™ power MOSFET solutions can be selected.

As shown in the quick start guide, the easiest and immediate way-to-use the board is with zero-power applied to the MOSFETs. In that operating condition, the 1EDN7550B load is equivalent to a pure RC filter. Testing with different MOSFETs is a suggested option to evaluate and understand the impact of the MOSFETs input capacitance on the driving timing behavior.

Moreover, the evaluation kit allows to evaluate the robustness of the 1EDN7550B to DC ground shifts, which is the key strength of the arising driving concept with truly differential inputs. The board provides, in fact, the possibility to differentiate the ground voltage of the driver and its input stage reference voltage (ground of the function generator).

Summary of features and benefits:

- › Complete and easy-to-use solution platform integrating Infineon's 1EDN7550B EiceDRIVER™ gate driver IC and CoolMOS™ or OptiMOS™ power MOSFET
- › Possible to evaluate the influence of the gate load (R_g or C_{gs}) on the driving behavior of the 1EDN7550B
- › Possible to evaluate the robustness of the 1EDN7550B to DC offsets between the driver ground and the function generator ground
- › Easy to replace and test different power MOSFETs in TO-220 package

Kit schematic

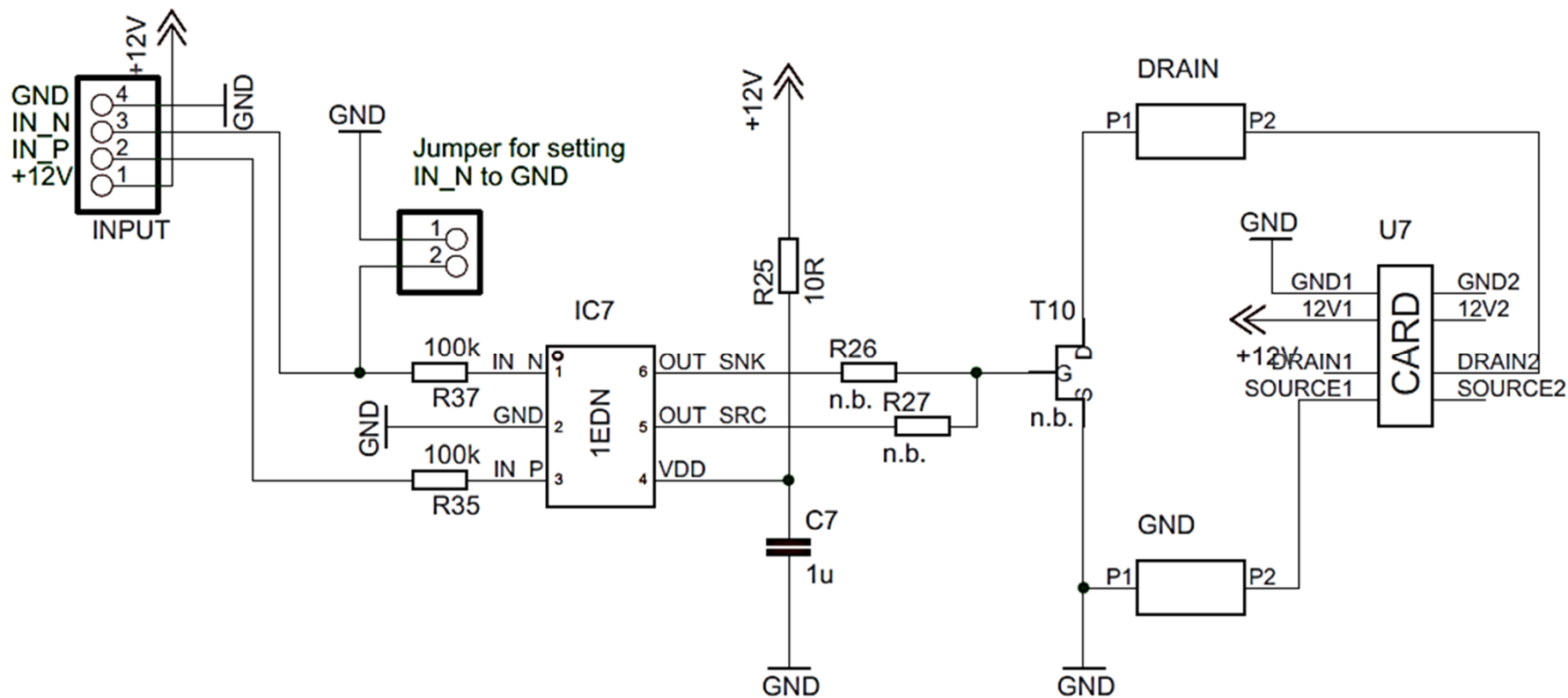

Steps for kit assembly

The following components need to be added to the kit:

- > Distance bolts
- > Source resistor
- > Sink resistor
- > TO-220 socket
- > TO-220 MOSFET

Step 1
Distance bolts mounting

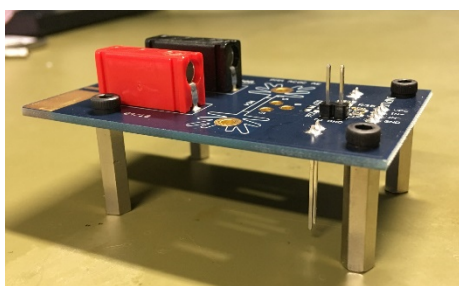

Step 4
TO-220 socket soldering

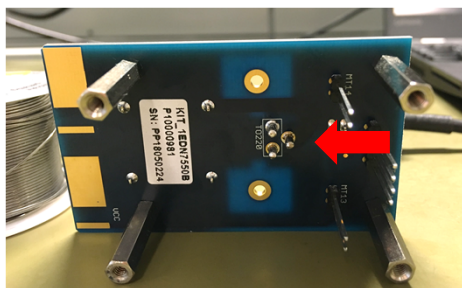

Step 2
Source resistor soldering

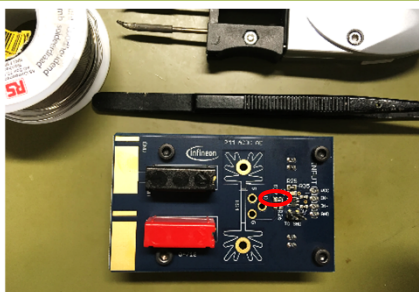

Step 5
MOSFETs placement into the socket

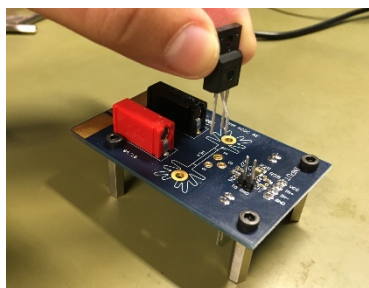

Step 3
Sink resistor soldering

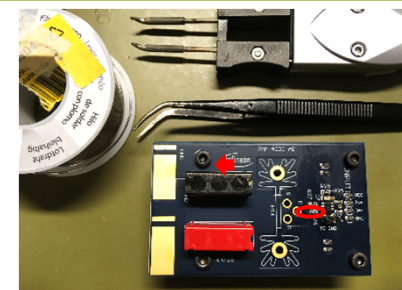

Step 6
Heatsink mounting

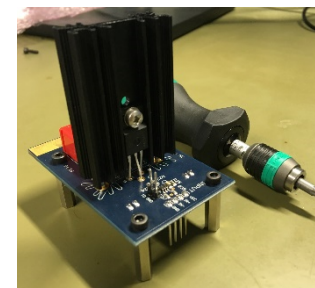

- > For detailed information on how to fully assemble the kit, download the [Quick Start Guide here](#)

Cross reference

Sales_product_name	Gate Driver	Channel	Isolation	Package
KIT_DRIVER_1EDN7511B	1EDN7511B	1	Non-isolated	SOT-23 6pin
KIT_DRIVER_1EDN7512B	1EDN7512B	1	Non-isolated	SOT-23 5pin
KIT_DRIVER_1EDN7512G	1EDN7512G	1	Non-isolated	WSON 6pin
KIT_DRIVER_1EDN7550B	1EDN7550B /1EDN8550B	1	Non-isolated	SOT-23 6pin
KIT_DRIVER_2EDN7524F	2EDN7524F	2	Non-isolated	DSO 8pin
KIT_DRIVER_2EDN7524R	2EDN7524R	2	Non-isolated	TSSOP 8pin
KIT_DRIVER_2EDN7524G	2EDN7524G	2	Non-isolated	WSON 8pin
KIT_DRIVER_2EDF7275F	2EDF7275F	2	Functional isolation	NB-DSO-16 150mil
KIT_DRIVER_2EDS8265H	2EDS8265H	2	Reinforced isolaton	WB-DSO-16 300mil



Technical Material

- > Application Notes
- > Simulation Models
- > Datasheets
- > PCB Design Data

> www.infineon.com/kit-driver-1edn7550b

Evaluation Boards

- > Evaluation Boards
- > Demoboards
- > Reference Designs

> www.infineon.com/evaluationboards

Videos

- > Technical Videos
- > Product Information Videos

> www.infineon.com/mediacenter

Support Online tools and services



- 1 **Subscribe to Newsletter**
- 2 **Where to Buy**
- 3 **Tools, Finders and Selectors**
- 4 **Support**

- **Products**
 - Applications
 - Tools
 - Support** (4)
 - Technology
- **Power**
 - Automotive System IC
 - ESD & EMI
 - Microcontroller
 - RF & Wireless Control
 - Security IC
 - Sensor
 - Smart Card IC
 - Interface
 - Transistor & Diode
- **Power Overview**
 - Power MOSFET
 - IGBT
 - Smart Low-Side & High-Side Switches
 - Linear Voltage Regulator
 - DC-DC Converter
 - LED Driver | Lighting ICs
 - Silicon Carbide (SiC)
 - High Power Thyristors & Diodes
 - Motor Control & Gate Driver
 - AC-DC Supply

News & Tweets



Part of your life. Part of tomorrow.

