

STEALTH™ Diode

50 A, 600 V

FFH50US60S-F085

Description

The FFH50US60S-F085 is a STEALTH™ diode optimized for low loss performance in output rectification. The STEALTH family exhibits low reverse recovery current (I_{RR}), low V_F and soft recovery under typical operating conditions. It has a low forward-voltage drop and is of silicon nitride passivated.

This device is intended for use as a freewheel/clamping diode in various automotive switching power supplies and other power switching applications. Its low stored charge as well as Stealth and soft recovery characteristics minimize ringing and electrical noise while reduce the overall power loss.

Features

- Stealth Recovery, $t_{rr} = 163$ ns (Typ.) @ $I_F = 50$ A)
- Low Forward Voltage ($V_F = 1.69$ V (Max.) @ $I_F = 50$ A)
- Avalanche Energy Rated
- AEC-Q101 Qualified
- This Device is Pb-Free

Applications

- Automotive DCDC Converter
- Automotive On Board Charger
- Switching Power Supply
- Power Switching Circuits

ABSOLUTE MAXIMUM RATINGS ($T_C = 25^\circ\text{C}$ unless otherwise noted)

Rating	Symbol	Value	Unit
Peak Repetitive Reverse Voltage	V_{RRM}	600	V
Working Peak Reverse Voltage	V_{RWM}	600	V
DC Blocking Voltage	V_R	600	V
Average Rectified Forward Current ($T_C = 25^\circ\text{C}$)	$I_{F(AV)}$	50	A
Non-repetitive Peak Surge Current (Halfwave 1 Phase 50 Hz)	I_{FSM}	150	A
Avalanche Energy (1 A, 40 mH)	E_{AVL}	20	mJ
Operating Junction and Storage Temperature	T_J, T_{STG}	-55 to +175	$^\circ\text{C}$

Stresses exceeding those listed in the Maximum Ratings table may damage the device. If any of these limits are exceeded, device functionality should not be assumed, damage may occur and reliability may be affected.



ON Semiconductor®

www.onsemi.com

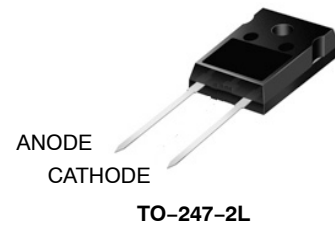

MARKING DIAGRAM

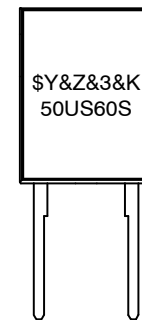

\$Y = ON Semiconductor Logo
 &Z = Assembly Plant Code
 &3 = Numeric Date Code
 &K = Lot Code
 50US60S = Specific Device Code

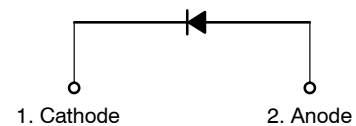

ORDERING INFORMATION

See detailed ordering and shipping information on page 2 of this data sheet.

FFH50US60S-F085

PACKAGE MARKING AND ORDERING INFORMATION

Device Marking	Device	Package	Tube	Quantity
FFH50US60S	FFH50US60S-F085	TO247-2L	-	30

ELECTRICAL CHARACTERISTICS ($T_C = 25^\circ\text{C}$ unless otherwise noted)

Symbol	Parameter	Test Conditions	Min.	Typ.	Max.	Unit		
I_R	Instantaneous Reverse Current	$V_R = 600\text{ V}$	$T_C = 25^\circ\text{C}$	-	-	100	μA	
			$T_C = 175^\circ\text{C}$	-	-	1000	μA	
V_{FM} (Note 1)	Instantaneous Forward Voltage	$I_F = 50\text{ A}$	$T_C = 25^\circ\text{C}$	-	1.27	1.69	V	
			$T_C = 175^\circ\text{C}$	-	1.19	1.57	V	
t_{rr} (Note 2)	Reverse Recovery Time	$I_F = 1\text{ A}$, $di/dt = 200\text{ A}/\mu\text{s}$, $V_R = 390\text{ V}$	$T_C = 25^\circ\text{C}$	-	41	82	ns	
			$T_C = 25^\circ\text{C}$	$I_F = 50\text{ A}$, $di/dt = 200\text{ A}/\mu\text{s}$, $V_R = 390\text{ V}$	-	163	-	ns
				$T_C = 175^\circ\text{C}$	-	364	-	ns
t_a t_b Q_{rr}	Reverse Recovery Time Reverse Recovery Charge	$I_F = 50\text{ A}$, $di/dt = 200\text{ A}/\mu\text{s}$, $V_R = 390\text{ V}$	$T_C = 25^\circ\text{C}$	-	65 98 886	- - -	ns ns nC	

1. Pulse : Test Pulse width = 300 μs , Duty Cycle = 2%

2. Guaranteed by design

Product parametric performance is indicated in the Electrical Characteristics for the listed test conditions, unless otherwise noted. Product performance may not be indicated by the Electrical Characteristics if operated under different conditions.

TEST CIRCUITS AND WAVEFORMS

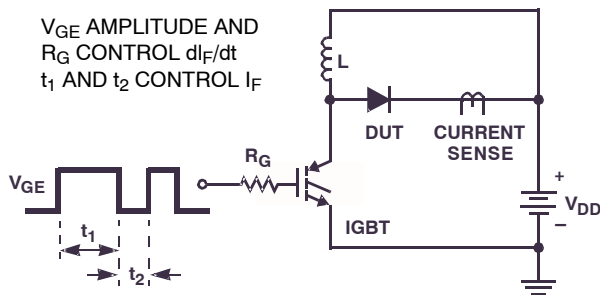

Figure 1. T_{rr} Test Circuit

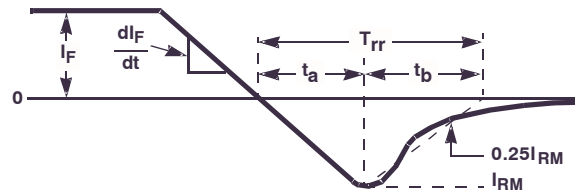

Figure 2. T_{rr} Waveforms and Definitions

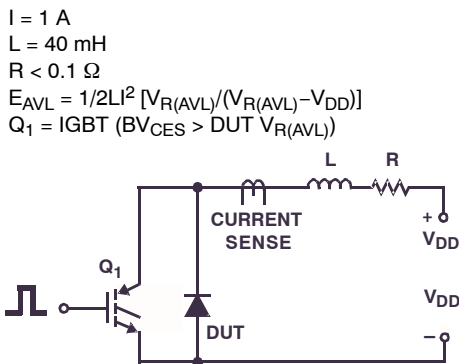

Figure 3. Avalanche Energy Test Circuit

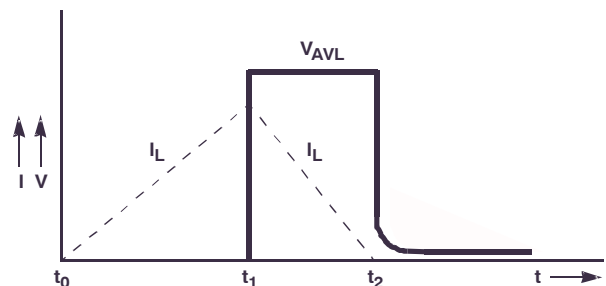

Figure 4. Avalanche Current and Voltage Waveforms

TYPICAL PERFORMANCE CHARECTERISTICS

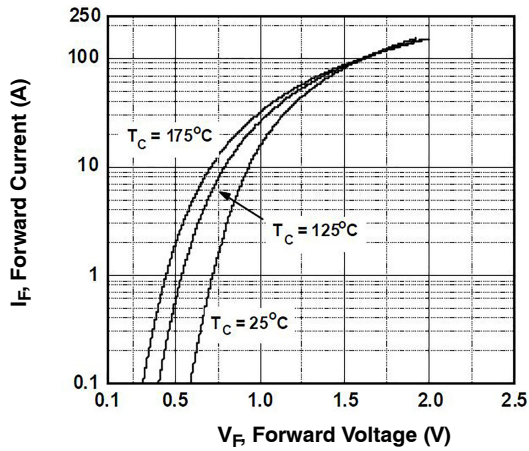

Figure 5. Typical Forward Voltage Drop vs. Forward Current

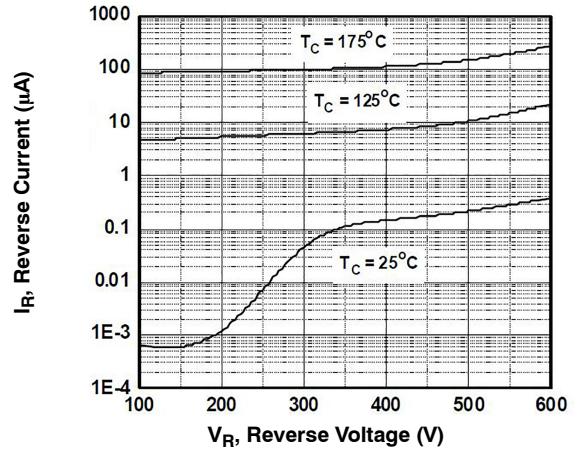

Figure 6. Typical Reverse Current vs. Reverse Voltage

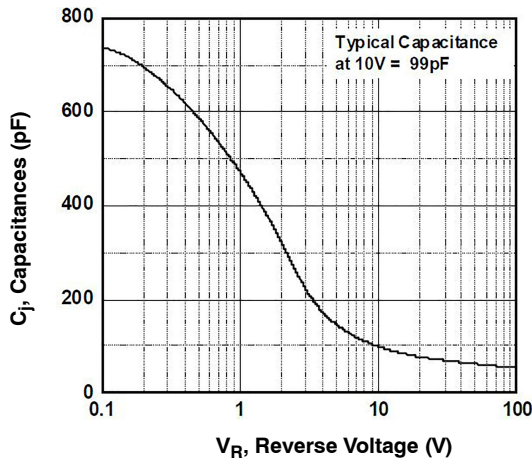

Figure 7. Typical Junction Capacitance

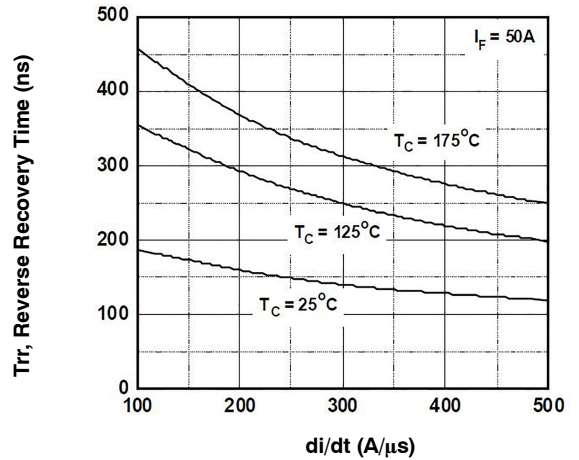

Figure 8. Typical Reverse Recovery Time vs. di/dt

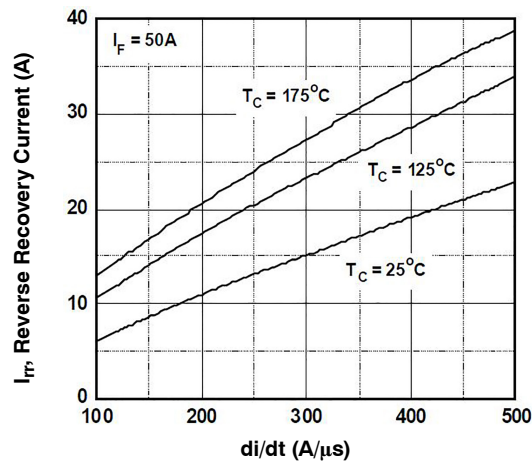

Figure 9. Typical Reverse Recovery Current vs. di/dt

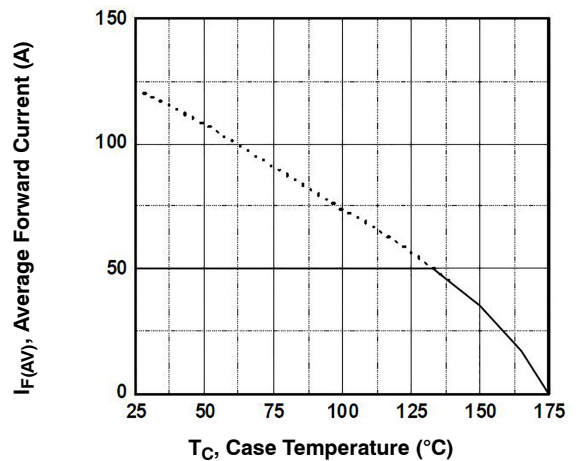

Figure 10. Forward Current Derating Curve

TYPICAL PERFORMANCE CHARACTERISTICS (continued)

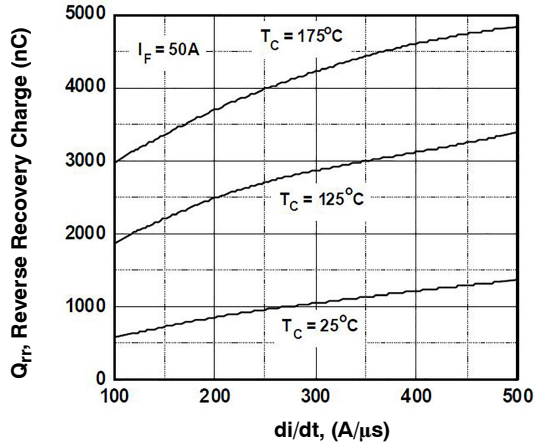

Figure 11. Reverse Recovery Charge

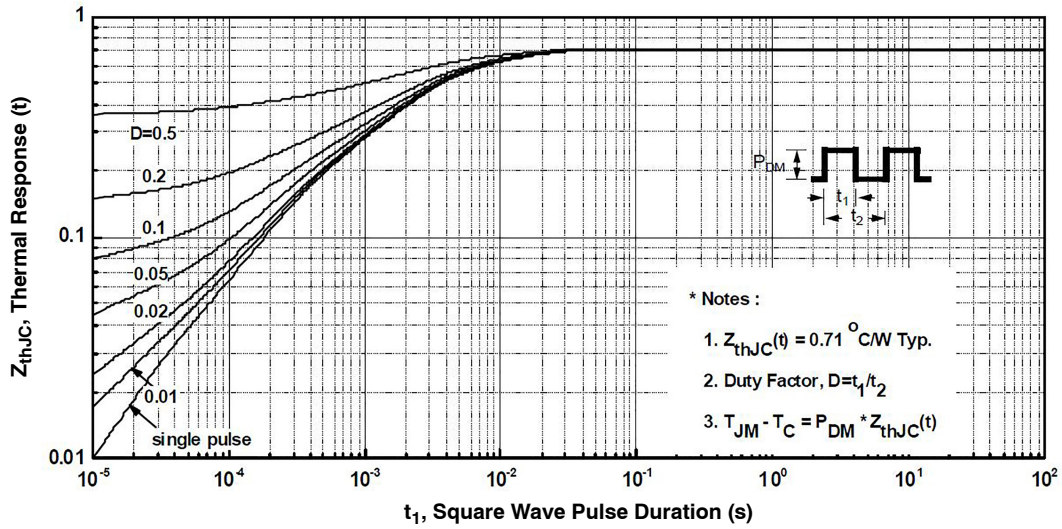

Figure 12. Transient Thermal Response Curve

MECHANICAL CASE OUTLINE

PACKAGE DIMENSIONS

ON Semiconductor®



TO-247-2LD
CASE 340CL
ISSUE A

DATE 03 DEC 2019

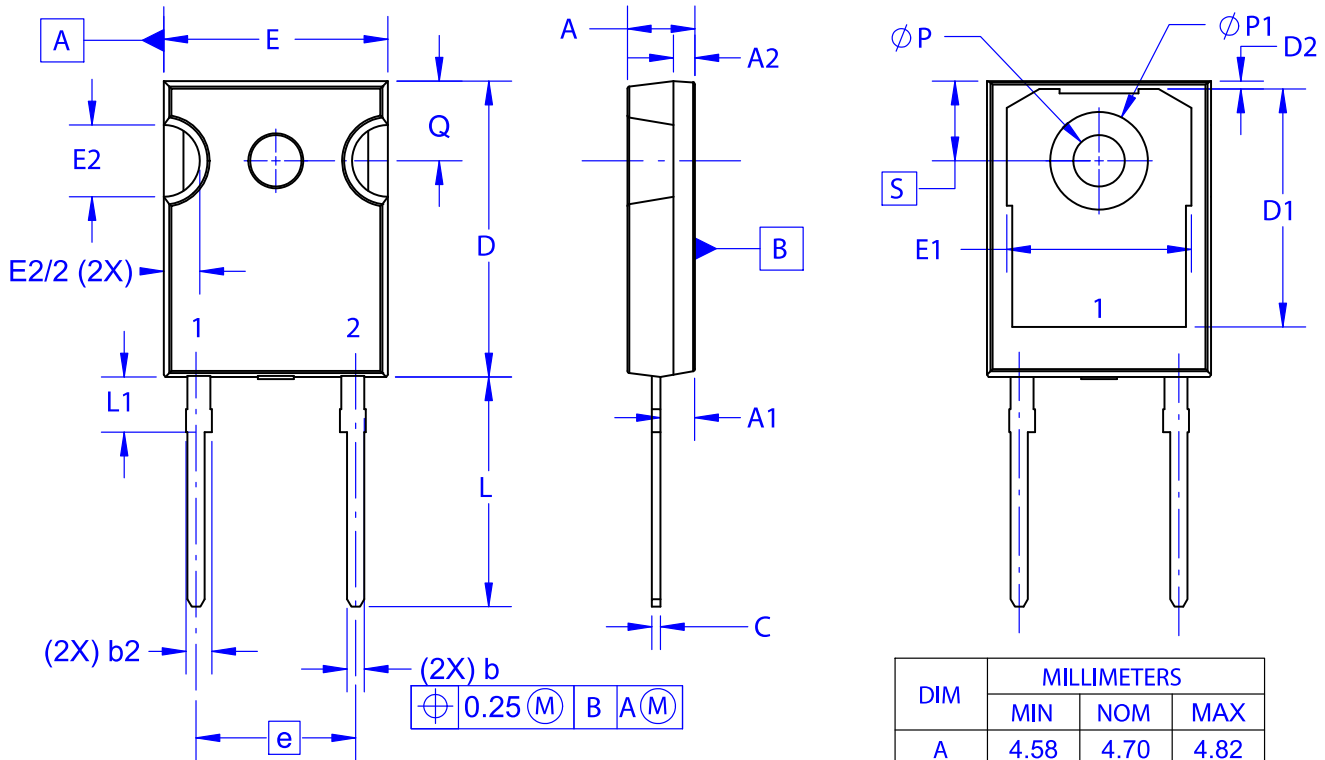

$\oplus 0.25 (M) B A (M)$

NOTES: UNLESS OTHERWISE SPECIFIED.

- A. DIMENSIONS ARE EXCLUSIVE OF BURRS, MOLD FLASH, AND TIE BAR EXTRUSIONS.
- B. ALL DIMENSIONS ARE IN MILLIMETERS.
- C. DRAWING CONFORMS TO ASME Y14.5 - 2009.
- D. DIMENSION A1 TO BE MEASURED IN THE REGION DEFINED BY L1.
- E. LEAD FINISH IS UNCONTROLLED IN THE REGION DEFINED BY L1.

GENERIC MARKING DIAGRAM*

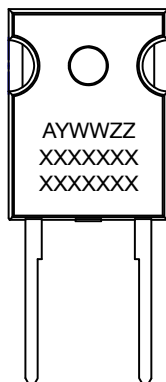

XXXX = Specific Device Code
A = Assembly Location
Y = Year
WW = Work Week
ZZ = Assembly Lot Code

*This information is generic. Please refer to device data sheet for actual part marking. Pb-Free indicator, "G" or microdot "•", may or may not be present. Some products may not follow the Generic Marking.

DIM	MILLIMETERS		
	MIN	NOM	MAX
A	4.58	4.70	4.82
A1	2.29	2.40	2.66
A2	1.30	1.50	1.70
b	1.17	1.26	1.35
b2	1.53	1.65	1.77
c	0.51	0.61	0.71
D	20.32	20.57	20.82
D1	16.37	16.57	16.77
D2	0.51	0.93	1.35
E	15.37	15.62	15.87
E1	12.81	~	~
E2	4.96	5.08	5.20
e	~	11.12	~
L	15.75	16.00	16.25
L1	3.69	3.81	3.93
∅P	3.51	3.58	3.65
∅P1	6.61	6.73	6.85
Q	5.34	5.46	5.58
S	5.34	5.46	5.58

DOCUMENT NUMBER:	98AON13850G	Electronic versions are uncontrolled except when accessed directly from the Document Repository. Printed versions are uncontrolled except when stamped "CONTROLLED COPY" in red.
DESCRIPTION:	TO-247-2LD	PAGE 1 OF 1

ON Semiconductor and are trademarks of Semiconductor Components Industries, LLC dba ON Semiconductor or its subsidiaries in the United States and/or other countries. ON Semiconductor reserves the right to make changes without further notice to any products herein. ON Semiconductor makes no warranty, representation or guarantee regarding the suitability of its products for any particular purpose, nor does ON Semiconductor assume any liability arising out of the application or use of any product or circuit, and specifically disclaims any and all liability, including without limitation special, consequential or incidental damages. ON Semiconductor does not convey any license under its patent rights nor the rights of others.

onsemi, **Onsemi**, and other names, marks, and brands are registered and/or common law trademarks of Semiconductor Components Industries, LLC dba "**onsemi**" or its affiliates and/or subsidiaries in the United States and/or other countries. **onsemi** owns the rights to a number of patents, trademarks, copyrights, trade secrets, and other intellectual property. A listing of **onsemi**'s product/patent coverage may be accessed at www.onsemi.com/site/pdf/Patent-Marking.pdf. **onsemi** reserves the right to make changes at any time to any products or information herein, without notice. The information herein is provided "as-is" and **onsemi** makes no warranty, representation or guarantee regarding the accuracy of the information, product features, availability, functionality, or suitability of its products for any particular purpose, nor does **onsemi** assume any liability arising out of the application or use of any product or circuit, and specifically disclaims any and all liability, including without limitation special, consequential or incidental damages. Buyer is responsible for its products and applications using **onsemi** products, including compliance with all laws, regulations and safety requirements or standards, regardless of any support or applications information provided by **onsemi**. "Typical" parameters which may be provided in **onsemi** data sheets and/or specifications can and do vary in different applications and actual performance may vary over time. All operating parameters, including "Typicals" must be validated for each customer application by customer's technical experts. **onsemi** does not convey any license under any of its intellectual property rights nor the rights of others. **onsemi** products are not designed, intended, or authorized for use as a critical component in life support systems or any FDA Class 3 medical devices or medical devices with a same or similar classification in a foreign jurisdiction or any devices intended for implantation in the human body. Should Buyer purchase or use **onsemi** products for any such unintended or unauthorized application, Buyer shall indemnify and hold **onsemi** and its officers, employees, subsidiaries, affiliates, and distributors harmless against all claims, costs, damages, and expenses, and reasonable attorney fees arising out of, directly or indirectly, any claim of personal injury or death associated with such unintended or unauthorized use, even if such claim alleges that **onsemi** was negligent regarding the design or manufacture of the part. **onsemi** is an Equal Opportunity/Affirmative Action Employer. This literature is subject to all applicable copyright laws and is not for resale in any manner.

ADDITIONAL INFORMATION

TECHNICAL PUBLICATIONS:

Technical Library: www.onsemi.com/design/resources/technical-documentation
onsemi Website: www.onsemi.com

ONLINE SUPPORT: www.onsemi.com/support

For additional information, please contact your local Sales Representative at www.onsemi.com/support/sales

