

600A True RMS Digital Clamp Meters

EX650 Series

EX650 True RMS 600A AC Digital Clamp Meter

EX655 True RMS 600A AC/DC Clamp Meter with Temperature, Inrush, and Low Pass Filter

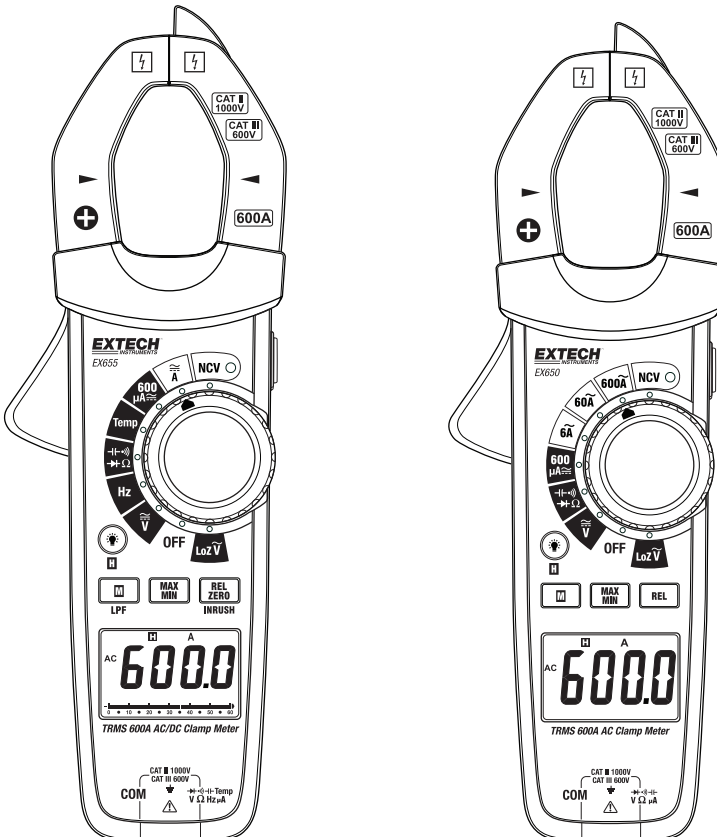

Table of Contents

1. INTRODUCTION	3
2. SAFETY INFORMATION	4
3. DESCRIPTIONS	6
4. OPERATION	11
Powering the Meter	11
Disable Auto Power OFF	11
Display Backlight	11
Work Light	11
Data Hold	12
Test Lead Considerations	12
Voltage Measurements	12
'Lo Z' AC Voltage Measurements	15
Current Measurements Using the Clamp	16
µA AC/DC Current Measurements using Test Leads	18
Non-Contact Voltage Detector	19
Resistance Measurements	20
Continuity Measurements	22
Capacitance Measurements	23
Frequency Measurements (EX655)	25
Diode Test	26
Temperature Measurements (EX655 only)	27
Extended Functionality Modes	28
Inrush Current Mode (EX655 only)	28
DCA ZERO (EX655 only)	29
MAX-MIN Mode	29
Low Pass Filter (LPF) EX655 only	30
Relative Δ Mode	30
5. MAINTENANCE	31
6. SPECIFICATIONS	32

1. Introduction

Thank you for selecting the Extech EX650 Series Clamp Meter.

The EX650 is a feature-packed True RMS digital Clamp meter series with 6000 count backlit display and automatic ranging.

Measure AC/DC voltage, AC current, DC current (EX655), Inrush current (EX655), Resistance, Diode, Continuity, Capacitance, Temperature (EX655), Lo 'Z' low impedance mode, and Frequency (EX655).

Other functions include Data Hold, Maximum/Minimum Memory, Relative mode, Low Pass Filter (LPF) for Variable Frequency Drive signals (EX655), Work light, NCV (Non-Contact Volt Detection), and Auto power-off.

This device is shipped fully tested and calibrated and, with proper use, will provide years of reliable service. Please visit our website (www.extech.com) to check for the latest version of this User Guide, Product Updates, Product Registration, and Customer Support.

Features

- 6000 count digital display
- 60 segment analog bar graph display on EX655 model
- Large backlit LED display
- True RMS AC measurements
- Lo Z mode eliminates ghost voltage readings on non-energized circuits
- Auto and Manual Range modes
- 0.5% DCV accuracy
- Data Hold
- Inrush current mode on EX655 model
- Relative mode
- Auto Power OFF (APO) with disable function
- Temperature measurements (Model EX655 only) with included temperature probe
- 600A AC current measurements
- 600A DC Current Measurements on EX655 model
- Non-Contact Voltage Detector
- Visual and audible continuity measurement alert
- Low battery indicator
- Includes test leads, Type-K temperature probe (EX655), and three (3) 1.5V AAA batteries.
- CAT III 600V / CAT II 1000V

2. Safety Information

To ensure the safe operation and service of the meter, follow these instructions closely. Failure to observe warnings can result in severe injury.



WARNINGS

WARNINGS identify hazardous conditions and actions that could cause BODILY HARM or DEATH.

- When handling test leads or probes, keep hands and fingers behind the finger guards at all times. To avoid electrical shock do not touch exposed electrical wire, connectors, unused input terminals, or circuits under test.
- Remove test leads from the meter before opening the battery compartment or meter housing.
- Use the meter only as specified in this User Guide or accompanying Quick Start to avoid compromising the protections provided by the meter.
- Be sure to use the proper terminals, switch positions, and ranges when taking measurements.
- Verify the meter's operation by measuring a known voltage. Have the meter serviced if the meter responds unusually or if there are questions regarding the meter's functional integrity.
- Do not apply more than the rated voltage, as marked on the meter, between terminals or between any terminal and earth ground.
- Do not measure voltages above 1000VDC or 750V AC between terminal and ground to prevent electrical shock and damage to the Clamp meter.
- Use caution working with voltages above 30 VAC RMS, 42 VAC peak, or 60 VDC. These voltages pose a shock hazard.
- To avoid misleading readings that could lead to electric shock and injury, replace the batteries as soon as the low battery indicator is displayed.
- Disconnect power to the circuit under test and discharge all high-voltage capacitors before testing resistance, continuity, diodes, or capacitance.
- Do not use the meter in the presence of explosive gas or vapor.
- To reduce risk of fire or electric shock, do not use the meter if it is wet and do not expose the meter to moisture.
- Individual protective equipment should be used if HAZARDOUS LIVE parts in the installation where measurements are to be carried out could be accessible.













CAUTIONS

CAUTIONS identify conditions and actions that could cause DAMAGE to the meter or equipment under test. Do not expose the meter to extremes in temperature or high humidity.

- Disconnect the test leads from the test points before changing the position of the function (rotary) switch.
- Do not expose the meter to extremes in temperature or to high humidity.
- Never set the meter to the resistance, diode, capacitance, micro-amp, or amp functions when measuring the voltage of a power supply circuit; this could result in meter damage and damage to the equipment under test.

Safety Symbols that are typically marked on meters and instructions

	This symbol, adjacent to another symbol, indicates the user must refer to the manual or user guide for further information.
	Risk of electrical shock
	Fuse symbol
	Equipment protected by double or reinforced insulation
	Low Battery symbol
	Conforms to EU directives
	Do not discard this product in household trash.
	AC measurement
	DC measurement
	Earth ground

Unsafe Voltage Alert

When the meter detects a voltage equal to or greater than 30V or a voltage overload (OL) in V or Lo Z mode, the symbol  is displayed. This system was designed to alert the user of a potentially hazardous voltage.

PER IEC1010 OVERVOLTAGE INSTALLATION CATEGORY

OVERVOLTAGE CATEGORY I

Equipment of OVERVOLTAGE CATEGORY I is equipment for connection to circuits in which measures are taken to limit the transient over-voltages to an appropriate low level.

Note – Examples include protected electronic circuits.

OVERVOLTAGE CATEGORY II

Equipment of OVERVOLTAGE CATEGORY II is energy-consuming equipment to be supplied from the fixed installation.

Note – Examples include household, office, and laboratory appliances.

OVERVOLTAGE CATEGORY III

Equipment of OVERVOLTAGE CATEGORY III is equipment in fixed installations.

Note – Examples include switches in the fixed installation and some equipment for industrial use with permanent connection to the fixed installation.

OVERVOLTAGE CATEGORY IV

Equipment of OVERVOLTAGE CATEGORY IV is for use at the origin of the installation.

Note – Examples include electricity meters and primary over-current protection equipment

3. Descriptions

Meter Description (EX655 pictured)

1. Non-Contact Voltage Detector
2. Clamp jaw
3. Work Light ON/OFF button
4. NCV alert LED lamp
5. Rotary function switch
6. Max-Min button
7. Relative Δ , DCA Zero, and Inrush button (DCA Zero & Inrush on EX655 only)
8. LCD multi-function display with backlighting
9. Positive input terminal
10. Common (-) input terminal
11. Mode (M) and LPF (low pass filter) button (LPF on EX655 only)
12. Backlight and Hold button
13. Jaw Trigger
14. Work Light

Note: Battery compartment on back of meter

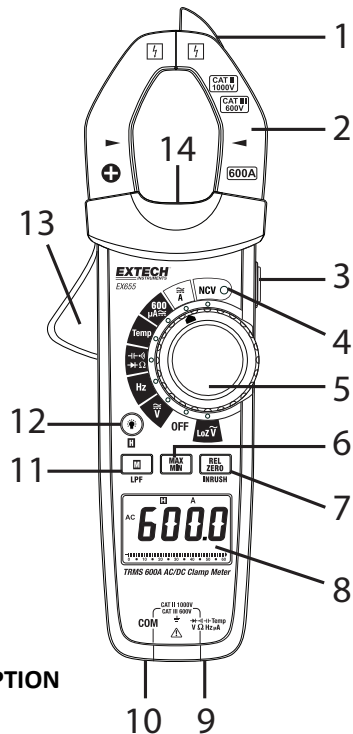

Fig 3-1 METER DESCRIPTION

Display Icon Descriptions for EX650

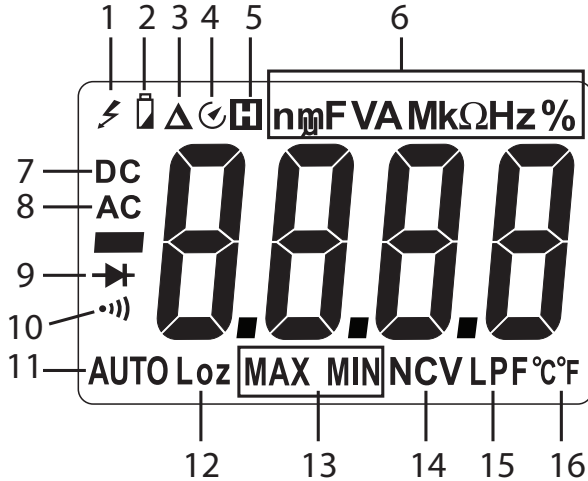

Fig 3-2 EX650 METER DISPLAY

1. High voltage
2. Battery status
3. Relative mode
4. Auto power off
5. Data hold
6. Units of measure
7. Direct Current
8. Alternating Current
9. Diode
10. Continuity
11. Automatic range
12. Low Impedance mode (Lo Z)
13. Maximum and Minimum memory
14. Non-Contact Voltage Detector
15. Low Pass Filter (LPF)
16. Temperature units

Display Icon Descriptions for EX655

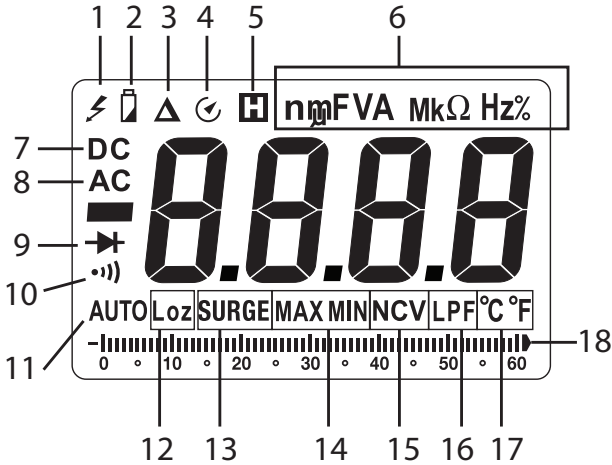

Fig 3-3 EX655 METER DISPLAY

1. High voltage
2. Battery status
3. Relative mode
4. Auto power off
5. Data hold
6. Units of measure
7. Direct Current
8. Alternating Current
9. Diode
10. Continuity
11. Automatic range
12. Low Impedance mode (Lo Z)
13. Inrush Current (Surge)
14. Maximum and Minimum memory
15. Non-Contact Voltage Detector
16. Low Pass Filter (LPF)
17. Temperature units
18. Bargraph

Push-Button Descriptions



Momentary presses of the **M** (MODE) button perform the functions shown in the table below. Press and hold the button to activate/deactivate the Low Pass Filter (EX655 only).

Fig. 3-4 (a) EX655 MODE Button Function Table

Switch Position	MODE (M) Button Function
	AC → Hz → DC
	AC ↔ DC
	Ω →))) → ⇄ → ⇄
TEMP	°C ↔ °F

Fig. 3-4 (b) EX650 MODE Button Function Table

Switch Position	MODE (M) Button Function
	AC ↔ DC
	AC ↔ DC
	Ω →))) → ⇄ → ⇄



Momentarily press to access/exit the Relative mode. This mode of operation is only available for DC voltage, AC Current, Resistance, and Capacitance.

In DC Mode, press to zero the display (EX655 only)

When the EX655 is in the ACA mode, press and hold to access the Inrush mode.



Press to access the MIN/MAX mode. The MAX icon will appear along with the stored highest reading. Press again to view the minimum reading stored (MIN icon displayed). Continue to use the button in this manner as desired. Press and hold the button to exit the MIN/MAX mode. This mode of operation is only available for AC/DC Voltage/Current, Resistance, and Temperature.



Press and hold this button to activate/deactivate the Data Hold function. Momentary presses switch the display backlight ON or OFF.

Fig 3-5(a) - Function Switch Description (EX655)

1. Low Impedance mode for AC Voltage measurements
2. Meter POWER OFF position
3. AC/DC Voltage and Hz for ACV (use MODE button to choose AC, Hz, or DC)
4. Frequency mode
5. Capacitance, Continuity, Diode, Resistance modes (use MODE button to choose mode)
6. Temperature mode
7. 600 μ A AC/DC Current mode (use MODE button to choose AC or DC)
8. AC/DC 600A Current mode (use MODE button to choose AC or DC)
9. Non-Contact Voltage Detect position with alert LED

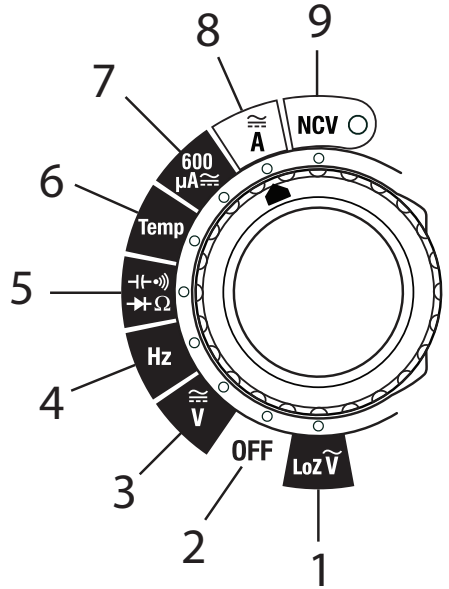
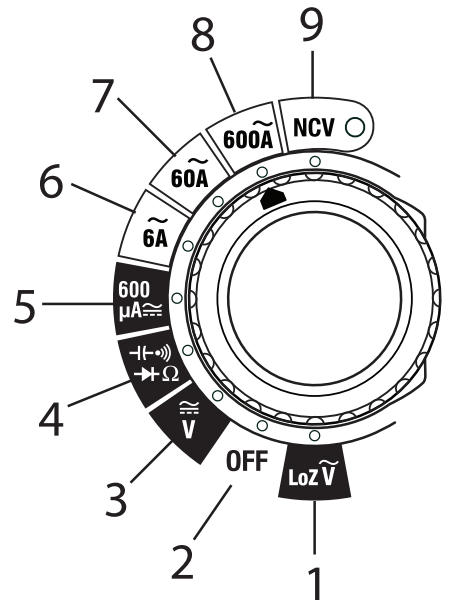

Fig 3-5(b) - Function Switch Description (EX650)

1. Low Impedance mode for AC Voltage measurements
2. Meter POWER OFF position
3. AC/DC Voltage (use MODE button to choose AC or DC)
4. Capacitance, Continuity, Diode, Resistance modes (use MODE button to choose mode)
5. 600 μ A AC/DC Current mode (use MODE button to choose AC or DC)
6. 6A AC Current mode
7. 60A AC Current mode
8. 600 A AC Current mode
9. Non-Contact Voltage Detect position with alert LED



4. Operation



CAUTION: Read and understand all of the Safety statements listed in the safety section of this manual prior to use.

Powering the Meter

1. Turn the rotary function switch to any position to power the meter. Check the batteries if the unit fails to power ON. Refer to the Maintenance section for battery replacement information.
2. Turn the function switch to the OFF position to power OFF the meter.
3. The meter has an Auto Power OFF sleep feature (APO) where the meter enters sleep mode after 15 minutes of inactivity. Press the Mode button to awaken the meter. When APO is enabled, the APO icon will show on the display when the meter is powered ON. To disable APO, refer to the next section.

The low battery symbol  appears on the display when the battery voltage weakens below the threshold.

Disable Auto Power OFF

The meter will enter sleep mode after 15 minutes of inactivity. Press the Mode button to awaken the meter. To defeat this feature, follow the steps below.

1. With the meter OFF, press and hold the **M** (MODE) button and, while continuing to hold, turn the rotary function switch to any position to power ON the meter.
2. The EX650 will beep five times indicating that APO has been disabled. The EX655 will beep two times indicating that APO has been disabled.
3. Release the button.
4. APO will now be disabled until the next cycle of power.

Display Backlight

With the meter powered ON, press and hold the backlight button  to switch the backlight ON or OFF. Note that excessive use of the backlight will shorten the battery life.

Work Light

With the meter powered ON, press and hold the Work Light button on the right side of the meter. A momentary press will switch the Work Light off. The Work Light lamp is located on the back of the unit toward the bottom of the clamp jaw. Note that excessive use of the backlight will shorten the battery life.

Data Hold

To freeze the LCD meter reading, press the **H** (HOLD) button. While data hold is active, the **HOLD** display icon appears on the LCD. Press the **H** button to return to normal operation. The **HOLD** icon will switch OFF.

Test Lead Considerations

Test lead probe covers can be removed for CAT II 1000V installations. Use the test lead probe covers for CAT III 1000V or CAT IV 600V installations. Do not measure voltages > 1000V AC or DC. Remove the storage caps from the meter end of test leads before connecting leads to the meter.

Voltage Measurements



WARNING:

Remove the test lead probe covers for CAT II 1000V installations. Use the test lead probe covers for CAT III 600V installations.

Do not measure voltages greater than 750VAC or 1000VDC.



CAUTION: When connecting the test leads to the circuit or device under test, connect the black lead before the red; when removing the test leads, remove the red before the black lead.

Disconnect probes and circuit under test after all measurements are completed.



The meter displays a high voltage warning prompt “” when the voltage measured is > 30VAC. The instrument will automatically beep and show the high voltage warning prompt flashing if the voltage input exceeds 750VAC or 1000VDC.

Notes:

AC measurements incorporate true RMS AC coupling. The accuracy of non-sinusoidal waves must be adjusted as follows:

- Crest factor 1~2, accuracy increases by 3%
- Crest factor 2~2.5, accuracy increases by 5%
- Crest factor 2.5~3, accuracy increases by 7%

In order to obtain accurate readings in the measurement of 600mV, use the relative measurement mode. First short-circuit the probe input in, order to zero the reading, and then press the REL button; now read the voltage measured. The instrument automatically subtracts the short-circuit display value of the probe from the reading.

AC Voltage Measurements

1. Insert the black test lead banana plug into the negative (COM) jack and the red test lead banana plug into the positive (V/ Ω) jack.
2. Turn the function switch to the \overline{V} position. Use the **M (MODE)** button to select AC.
3. Read the Warning and Caution statements above to determine whether or not to use the test lead probe covers.
4. Touch the test probe tips to the circuit under test.
5. Read the digital value and the 60-segment bargraph (EX655 only) on the display. The meter is Auto Ranging (Auto displayed on LCD) and therefore selects the proper decimal point position. The meter also displays the measurement type, unit symbols, and other relevant multifunction icons.
6. Use the **M** button to view the frequency (**Hz**) of the measured voltage (EX655 only).
Important note: Wait until the meter is setup and actively measuring the voltage signal before accessing the Hz measurement mode.
7. Note the voltage alert symbol  when voltage is present.
8. The meter is capable of detecting AC voltages to 750V.
9. For EX655 only: Press and hold the **LPF** button to engage the Low Pass Filter circuit (the LPF icon will display). Press and hold LPF again to exit this mode. See the Low Pass Filter section for more details.
10. Set the function switch to the **LoZ** position to engage the low impedance circuit (the impedance will now be approximately 3k Ω). See the dedicated Lo Z section of this guide.

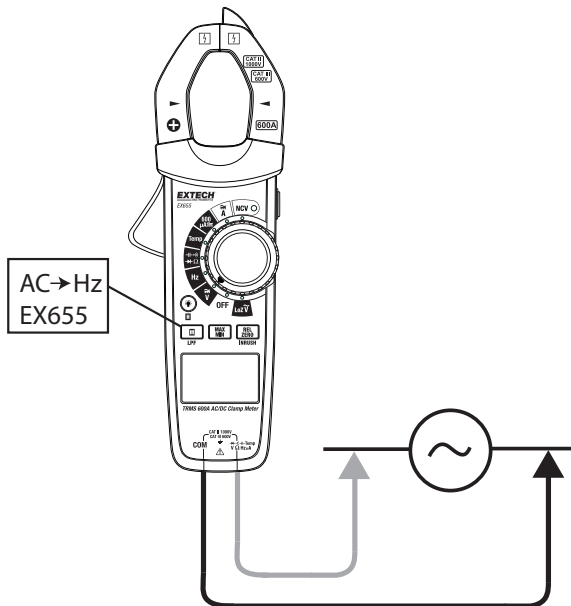



Fig 4-1 AC VOLTAGE MEASUREMENTS

DC Voltage Measurements

1. Insert the black test lead banana plug into the negative (COM) jack and the red test lead banana plug into the positive (V/ Ω) jack.
2. Move the Function Switch to the \overline{V} position.
3. Use the **M** button to select **DC**.
4. Read the Warning and Caution statements at the beginning of the Voltage Measurement section to determine whether or not to use the test lead probe covers.
5. Touch the test probe tips to the circuit under test. Be sure to observe the correct polarity (red lead to positive, black lead to negative).
6. Read the digital value and the bar graph representation (EX655) of the measurement in the display. The display will also indicate the proper decimal point (Auto Range) and measurement type/units symbols. If the polarity is reversed, the display will show (-) minus before the value.
7. Note the voltage alert symbol  when voltage is present.
8. The meter is capable of detecting DC voltages to 1000V.

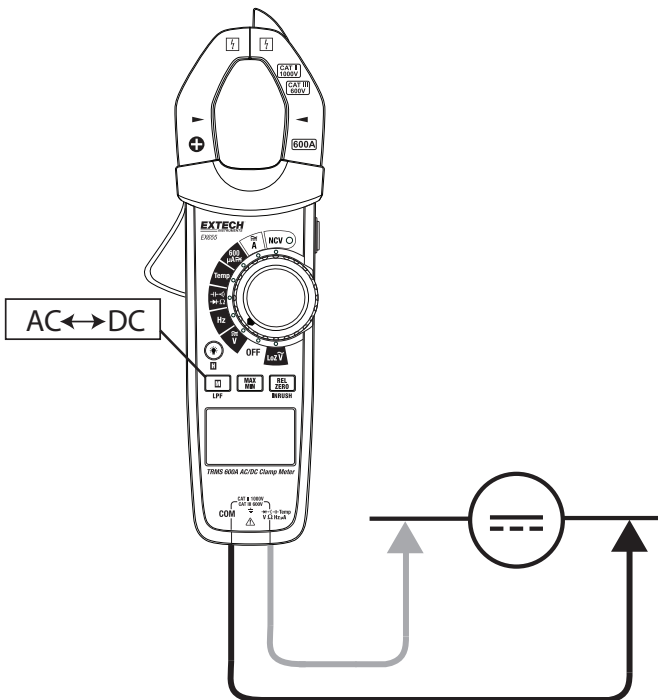



Fig 4-2 DC VOLTAGE MEASUREMENTS

'Lo Z' AC Voltage Measurements

The normal high input impedance (voltage measurement  position) would typically be used for all AC voltage tests. However, if a voltage on a non-energized line is detected use the Lo Z setting to determine if the voltage is really there or is it a ghost voltage.

When the function switch is turned to the **Lo Z** position a low impedance (Z) test circuit is engaged that eliminates ghost voltages on non-energized lines. Refer to the Voltage Measurements section earlier in this guide for Safety information and connection diagrams.

**The Lo Z impedance is approx. 3k Ω .*

1. Insert the black test lead banana plug into the negative (COM) jack and the red test lead banana plug into the positive (V/ Ω) jack.
2. Move the Function Switch to the **Lo Z** position.
3. Touch the test probe tips to the AC circuit under test. Be sure to observe the correct polarity (red lead to positive, black lead to negative).
4. Read the digital value and the 60-segment bargraph representation of the measurement (EX655) in the display. The display will also indicate the proper decimal point and measurement type/units symbols.
5. The meter is capable of detecting AC voltages to 600V in **Lo Z** mode. Note the voltage alert symbol when voltage is present.

Current Measurements Using the Clamp

 **WARNING:** Do not measure the current on a circuit when the voltage increases to more than 750V AC or 1000V DC. This can cause damage to the instrument and can cause injury to persons.

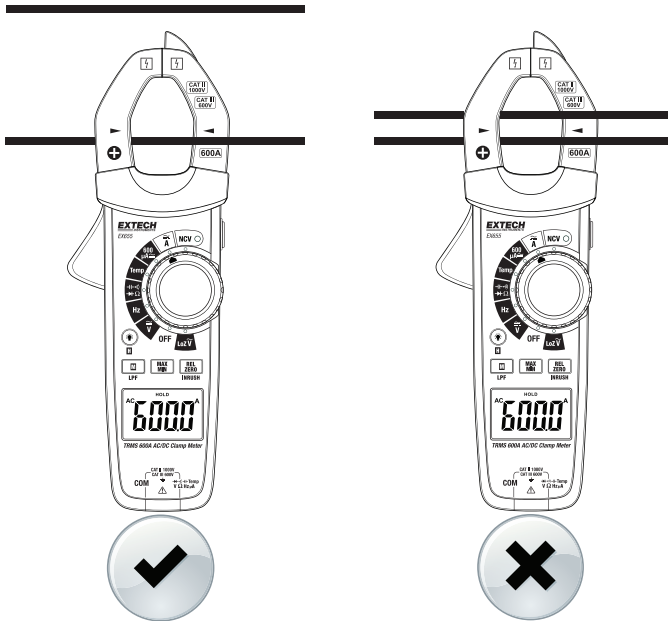



Fig. 4-3 Correct and Incorrect Clamping

1. Ensure that the probe leads are disconnected from the meter.
2. Set the function switch to the  for the EX655 or to the **6, 60, or 600**  positions on the EX650.
3. Use the **M** button to select **AC** or **DC**. For DC (EX655), press **ZERO** to remove any residual magnetism and to null the display before clamping onto a conductor.
4. Press the trigger to open the clamp jaws. Fully enclose only one conductor in the jaws (Refer to Fig. 4-3). For optimum results, center the conductor in the jaws.
5. Read the current measurement in the display represented by numerical digits (and the 60-segment bar graph on the EX655). The display will indicate the proper decimal point and value. In DC (EX655), when the polarity is reversed, the display will show (-) minus before the value.
6. Press and hold the **M** button to engage the LPF (Low Pass Filter) circuit (to measure inverters, VFD, etc.). Refer to the dedicated section on Low Pass Filtering.
7. Press and hold the **INRUSH** button to activate the Inrush Current utility (EX655 only). Refer to the dedicated Inrush Current section in this User Guide.



Current Measurement Considerations:

- Current measurement must be performed in the temperature range of 0~40°C (32 to 104°F).
- When pressing the trigger, do not suddenly release it; the clamp is sensitive to magnetism, heat, and mechanical stress and such impact will cause the reading to fluctuate briefly.
- If the reading is positive in the measurement of DC current, the direction of current is from top to bottom (meter faceplate is the top and the meter back is the bottom).
- In order to ensure measurement accuracy, the conductor measured must be positioned in the middle of the clamping area; otherwise additional error of reading of $\pm 1.0\%$ (typical) will be generated.
- The accuracy of non-sinusoidal waves must be adjusted as follows:
 - Crest factor 1~2, accuracy increases by 3%
 - Crest factor 2~2.5, accuracy increases by 5%
 - Crest factor 2.5~3, accuracy increases by 7%

μA AC/DC Current Measurements using Test Leads



WARNING: Do not handle the test leads above the finger/hand guard barrier.



CAUTION: Observe CAT II 1000V and CAT III 600V with respect to Earth Ground.

1. Insert the black test lead into the **COM** terminal and the red test lead into the **A** terminal.
2. Turn the meter's function switch to the μA  position. The μA unit symbol will appear on the display indicating that micro-amperes are being measured.
3. The meter display will show **AC** or **DC** (use the **M** button to select AC or DC).
4. Current measurements must be taken in series with the circuit under test. See accompanying diagram.
5. Touch the black test lead to the negative side of the circuit and the red test lead to the positive side of the circuit.
6. Read the current measurement in the display represented by the numerical digits and the bar graph (EX655). The display will indicate the proper decimal point and value. In DC, if the polarity is reversed, the display will show (-) minus before the value.

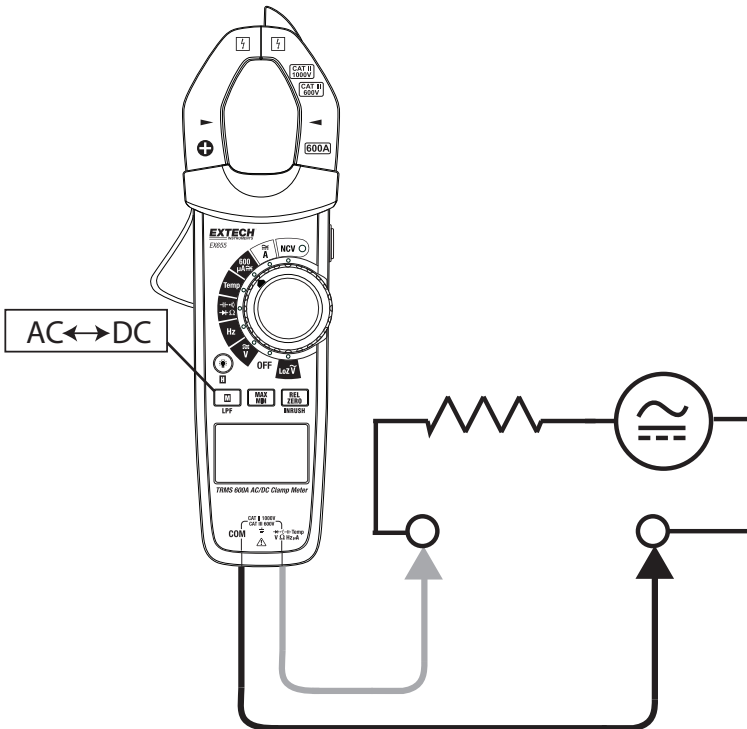

Fig 4-4 μA AC/DC CURRENT MEASUREMENTS

Non-Contact Voltage Detector



WARNING: It is possible for voltage to be present in a circuit even if the meter does not beep or flash the NCV LED lamp. Always verify meter operation on a known live AC current circuit and verify that the batteries are fresh before use.

When the meter senses an AC Voltage or electromagnetic field > 100VAC, the following occurs:

- The audible beeper sounds ON and OFF
- The LED lamp at the NCV function switch position flashes ON and OFF
- The display shows 1, 2, 3, or 4 dashes

The greater the electrical field strength, the faster the rate of the audible beeper, the flashing of the LED lamp, and the number of dashes displayed. If the meter does not emit a tone or flash the LED in this mode, there is still the possibility that voltage is present; **please use caution.**

1. Turn the function switch to the **NCV** position to select Non-Contact Voltage Detect mode.
2. Note that **EF** is displayed when in this mode. If the **EF** does not display when the function switch is turned to the NCV position, check the batteries and do not use the meter until **EF** is displayed.
3. To test, place the meter near a source of electrical energy. Note that the tip of the meter offers the highest sensitivity.
4. Note the audible beeping, the flashing LED, and the displayed dashes when a source of electrical energy is detected.

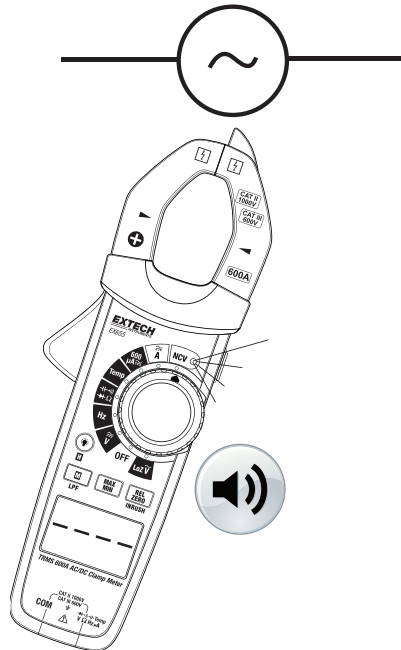

Fig 4-5 NON-CONTACT VOLTAGE DETECTOR

Resistance Measurements



CAUTION: Switch OFF power to the device under test before measuring. Do not test on circuits or devices where 60VDC or 30VAC is present.

1. Insert the black test lead banana plug into the negative (COM) jack. Insert the red test lead banana plug into the positive (V/ Ω) jack.
2. Turn the Function Switch to the Ω position.
3. Use the **M** button to select the Ω icon on the display indicating resistance only (without the continuity/diode/capacitance icons showing).
4. Touch the test probe tips across the circuit or part under test. It is best to disconnect one side of the part under test so the rest of the circuit will not interfere with the resistance reading.
5. Read the resistance value in the display. The display will indicate the proper decimal point and value. If the reading is out of range, the **OL** display icon will appear.

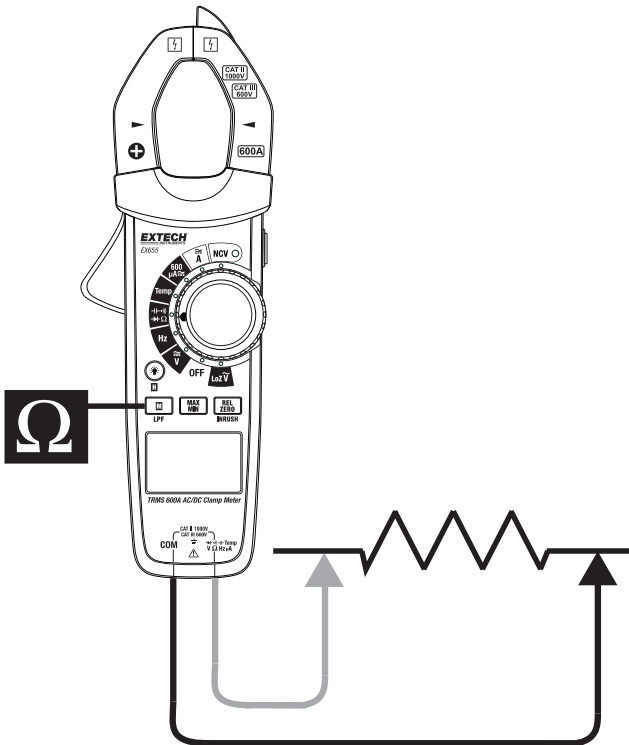

Fig 4-6 RESISTANCE MEASUREMENTS





Resistance Measurement Notes:

- The display will show “OL” when an open circuit is detected or if the resistance > maximum range.
- The test leads introduce an error of approx. $0.1\Omega \sim 0.2\Omega$ for low resistance measurements. Use the Relative mode to obtain accurate readings. Short the test leads together, press the REL button, and then measure a low resistance. The meter subtracts the short-circuit value from the reading.
- If the test lead resistance of probe is > 0.5Ω when shorted, inspect the test leads and the connection.
- It may take several seconds for the reading to stabilize when measuring resistance > $1M\Omega$. This is normal operation.
- For personal safety, do not measure a circuit with voltages > 30V DC or AC.

Capacitance Measurements



WARNING: To avoid electric shock, remove power to the circuit under test and discharge the capacitor under test before measuring. Do not test on circuits or devices where 60VDC or 30VAC is present.

1. Set the function switch to the  capacitance position.
2. Insert the black test lead banana plug into the negative **COM** jack and the red test lead banana plug into the positive  jack.
3. Press the **M** button to select the unit of measure symbol **F**.
4. Touch the test probe tips across the part under test.
5. Use the Relative mode  to compare measurements to a saved, known capacitance value. See the dedicated Relative mode instructions in this user guide for more detail.
6. Read the capacitance value in the display (bargraph is not available in capacitance mode).
7. The display will indicate the proper decimal point and value.

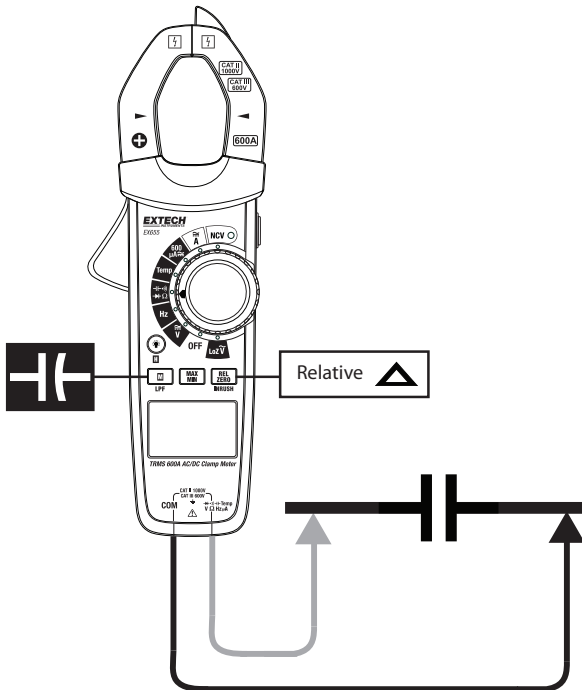

Fig 4-8 CAPACITANCE MEASUREMENTS



Capacitance Measurement Notes:

- The display will show “OL” if a capacitor is short-circuited or if the measured capacitance > maximum range of the instrument.
- The bargraph is not active in the capacitance measurement mode.
- Capacitance measurements > 600 μ F may require several seconds to obtain a stable reading.
- In order to ensure measurement accuracy, discharge residual charges before measuring capacitance; Use maximum safety when working with high voltage capacitors to prevent damage to the instrument and risk to personal safety.
- Disconnect test leads and circuit under test after measurements are completed.

Frequency Measurements (EX655)

1. Insert the black test lead banana plug into the negative (COM) jack. Insert the red test lead banana plug into the positive (V/ Ω) jack.
2. Turn the Function Switch to the Hz position.
3. Touch the test probe tips across the circuit under test.
4. Read the Frequency value in the display. The display will indicate the proper decimal point and value.
5. To read the frequency of a voltage signal being measured by the meter refer to the AC Voltage Measurements section of this guide.

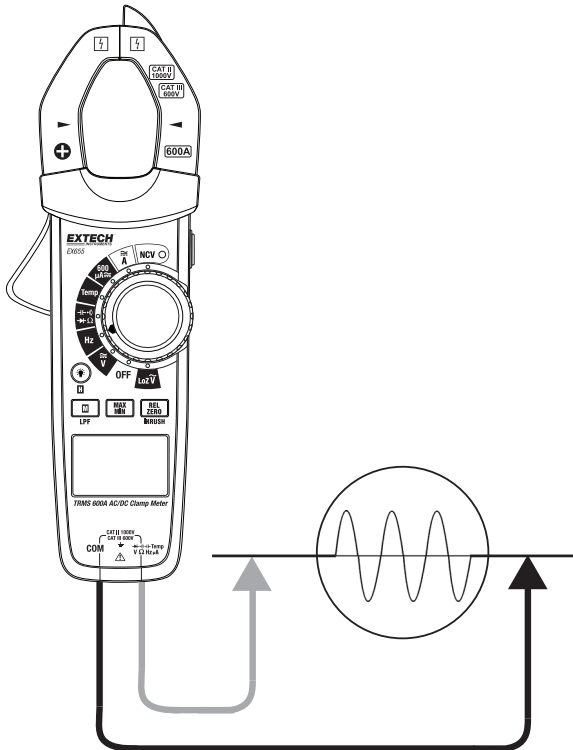

Fig 4-9 FREQUENCY MEASUREMENTS



Frequency Measurement Notes:

- Sensitivity:
 - $\leq 100\text{kHz}$: $100\text{mV}_{\text{rms}} \leq \text{input amplitude} \leq 20\text{V}_{\text{rms}}$
 - $> 100\text{kHz} \sim 1\text{MHz}$: $200\text{mV}_{\text{rms}} \leq \text{input amplitude} \leq 20\text{V}_{\text{rms}}$
- Disconnect test leads and circuit under test after measurements are completed.

Diode Test

1. Insert the black test lead banana plug into the negative **COM** jack and the red test lead banana plug into the **→** positive jack.
2. Turn the function switch to **→** position. Use the **M** button to select the diode function, the diode and voltage symbols will appear on the LCD when in Diode test mode.
3. Touch the test probe tips to the diode or semiconductor junction under test. Note the meter reading.
4. Reverse the test lead polarity by reversing the red and black leads. Note this reading.
5. The diode or junction can be evaluated as follows:
 - If one reading displays a value (typically 0.5V to 0.8V for silicon PN junction) and reverse reading displays **OL**, the diode is good.
 - If both readings display **OL** the device is open.
 - If both readings are very small or '**0**', the device is shorted.

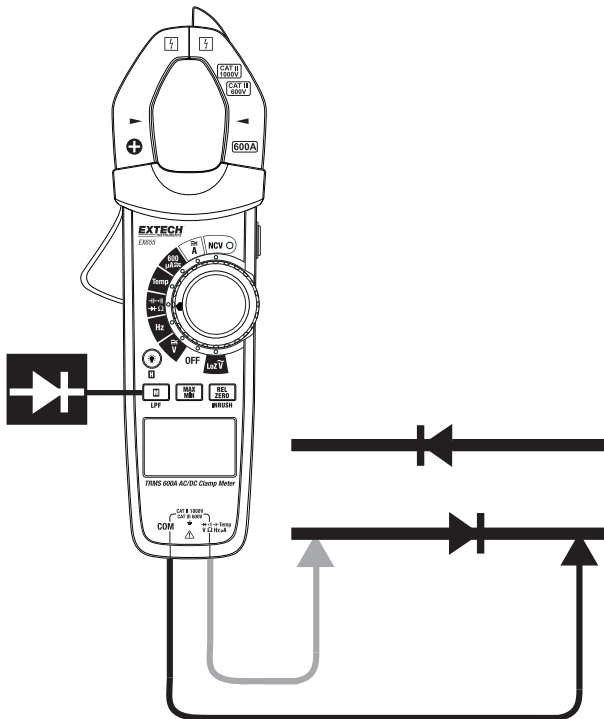

Fig 4-10 DIODE TESTING

Temperature Measurements (EX655 only)

1. Insert the supplied temperature probe into the **COM** and positive terminals observing correct polarity.
2. Turn the function switch to the **TEMP** position.
3. Use the **M** button to choose the temperature units **°C/°F**.
4. Touch the temperature probe tip to the device under test or leave the temperature probe in the open air to measure ambient temperature.
5. Read the temperature measurement on the display.

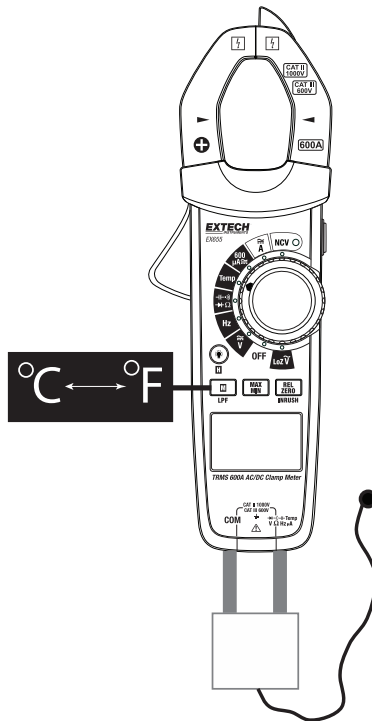

Fig 4-11 TEMPERATURE MEASUREMENTS

Temperature Measurement Note:

The ambient temperature of the meter should be in the range of 18 °C to 28°C (64°F to 82°F) otherwise temperature measurement accuracy will be affected.

Extended Functionality Modes

In addition to the basic measurements, a variety of extended functions are included. Refer to the following sections for details.

Inrush Current Mode (EX655 only)

In Inrush current mode, the meter displays the RMS AC current reading in the first 100ms period after the trigger point (current detection threshold) is reached, see Fig. 5.3 below. The current detection threshold is 5.0A for the 600.0A range. Inrush current mode is available when measuring AC current.

1. Connect the meter clamp to the unpowered circuit under test.
2. Set the meter to the **A** position.
3. Use the **MODE** button to select **AC**.
4. Press and hold the **INRUSH** button to enable the Inrush current mode. The word **RUSH** will display briefly in the area of the display where the readings are shown. The icon **SURGE** will appear on the lower portion of the LCD while in this mode.
5. Turn on the power to the circuit under test.
6. When the threshold is reached, the meter will display the RMS reading for the 100ms integration time.
7. To exit the Inrush mode, press and hold the **INRUSH** button until the SURGE display icon switches off.

Note: Inrush measurement accuracy is not specified; Inrush measurements are offered for reference purposes only.

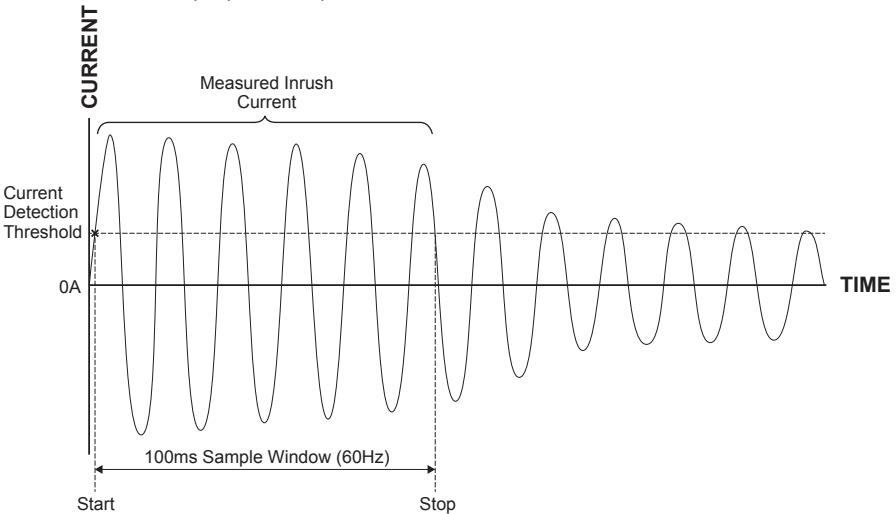

Figure 4-12 Inrush Current

DCA ZERO (EX655 only)

The DC ZERO feature removes any offset values and improves the accuracy for DC current measurements.



1. Turn the function switch to the **Δ** position and use the **M** button to select **DC**.
2. Ensure that there is no conductor in the clamp jaws.
3. Press the **ZERO** button; the delta symbol **Δ** will appear and the display will zero.
4. Take a DC Current reading as described earlier in this guide.
5. Press the **ZERO** button to exit the DC Zero mode; the delta symbol will switch off.

MAX-MIN Mode

In MAX-MIN mode, the meter captures and displays the Maximum and Minimum readings and updates only when a higher or lower value is registered.

1. Press the **MAX MIN** button to access this mode.
2. The **MAX** icon will appear and the displayed reading will represent the highest reading encountered since the **MAX MIN** button was first pressed.
3. Press the **MAX MIN** button again. The **MIN** icon will appear and the displayed reading will represent the lowest reading encountered since the **MAX MIN** button was first pressed.
4. Continue to use the **MAX MIN** button to step through the **MAX** and **MIN** readings as desired.
5. Press and hold the **MAX MIN** button for 2 seconds to exit this mode (the **MAX** and **MIN** icons should now be off). The meter will return to normal operation and the **MAX** and **MIN** memories will be reset.

Low Pass Filter (LPF) EX655 only

The LPF mode eliminates high frequency noise in voltage and current measurements by means of a low-pass filter. The LPF mode is designed for the measurement of Inverters, Variable Frequency Drives, etc. The display icon **LPF** (Low Pass Filter) is displayed when this mode is active.

1. Follow the instructions in this User Guide for measuring Current or Voltage.
2. Press and hold the LPF button until **LPF** icon appears. The Low Pass Filter is now active.
3. Take measurements as described in the Voltage or Current sections of this guide.
4. Press and hold the LPF button again to exit this mode. The LPF display icon will switch off and the meter will return to the normal operating mode.

Relative Δ Mode

In Relative mode a reference reading can be stored with which to compare subsequent readings. Press the Δ button to store the displayed reading in memory, this reading is now the reference. The symbol Δ will be displayed when the Relative mode is active.

Subsequent readings are compared to the stored reference (Displayed Reading = Measurement minus Reference). Press the Δ button again to exit the Relative mode; the Relative symbol will switch off.

Relative mode is available for Voltage, Current, and Capacitance modes only.

5. Maintenance



WARNING: To avoid electrical shock, remove the test leads, disconnect the meter from any circuit and turn OFF the meter before opening the case. Do not operate with an open case.

Battery Replacement

1. Remove the test leads from the meter.
2. Remove the Phillips head screw that secures the battery compartment at the back of the meter.
3. Open the battery compartment and replace the three (3) 1.5V 'AAA' batteries observing correct polarity. Re-assemble the meter before use

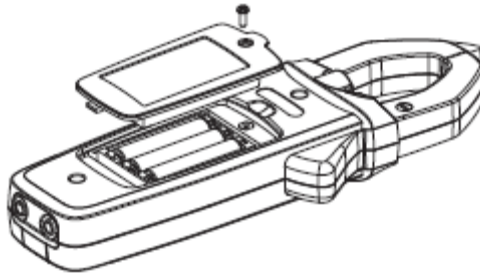

Battery Safety Notes: Please dispose of batteries responsibly; never dispose of batteries in a fire, batteries may explode or leak. If the meter is not to be used for 60 days or more, remove the battery and store separately. Do not mix battery types or freshness levels; please use batteries of the same type and of the same freshness level.



Never dispose of used batteries or rechargeable batteries in household waste. As consumers, users are legally required to take used batteries to appropriate collection sites, the retail store where the batteries were purchased, or wherever batteries are sold.

Disposal: Do not dispose of this instrument in household waste. The user is obligated to take end-of-life devices to a designated collection point for the disposal of electrical and electronic equipment.

Cleaning and Storage

Periodically wipe the case with a damp cloth and mild detergent; do not use abrasives or solvents. Please remove the batteries if the meter is stored for a long period of time.

6. Specifications

ELECTRICAL SPECIFICATIONS

Accuracy is given as \pm (% of reading + least significant digits) at 23 °C \pm 5 °C with relative humidity <80%.

Accuracy is specified for a period of one year after calibration.

1. Temperature Coefficient is 0.1 x specified accuracy / °C, < 18 °C (64.5 °F), > 28 °C (82.4 °F)
2. AC Functionality: ACV and ACA specifications are AC coupled, True RMS; For non-sinusoidal waveforms, additional accuracy Crest Factor (C.F.) considerations exist as detailed below:
 - Crest factor 1~2, accuracy increases by 3%
 - Crest factor 2~2.5, accuracy increases by 5%
 - Crest factor 2.5~3, accuracy increases by 7%

Function	Range	Resolution	Accuracy (reading)	'OL' Protection
AC Current	6.000 A*	0.001 A	\pm (2.5% + 30 digits)	600A
	60.00 A	0.01 A	\pm (2.5% + 5 digits)	
	600.0 A	0.1 A		
*6A range on EX650 only True RMS current applicable to 10%~100% of range; Frequency response: 50~60Hz Accuracy value increases (5% typical) when measuring varying frequency for non-sinusoidal wave (EX655) Inrush measurement accuracy is not specified; Inrush measurements are offered for reference purposes only.				
DC Current	60.00 A	0.01 A	\pm (2.5% + 5 digits)	600A
	600.0 A	0.1 A		
Use ZERO to null display before taking a measurement.				
AC Voltage	6.000V	0.001V	\pm (1.2% + 5 digits)	1000V DC 750V AC
	60.00V	0.01V		
	600.0V	0.1V		
	750V	1V	\pm (1.5% + 5 digits)	
True RMS voltage applicable to 10%~100% of the range Input Impedance: \geq 10M Ω ; Frequency response 40~400Hz Accuracy value increases (5% typical) when measuring varying frequency for non-sinusoidal wave (EX655)				
AC Voltage (LPF)	600.0 V	0.1V	\pm (6.5% + 5 digits)	1000V DC; 750V AC
AC Voltage (LoZ)	600.0 V	0.1V	\pm (1.5% + 5 digits)	1000V DC; 750V AC
Input Impedance is approx. 3k Ω ; Frequency response 40~400Hz				
DC Voltage	600.0mV	0.1mV	\pm (1.0% + 5 digits)	1000V DC 750V AC
	6.000V	0.001V	\pm (0.8% + 1 digit)	
	60.00V	0.01V	\pm (0.8% + 3 digits)	
	600.0V	0.1V		
	1000V	1V	\pm (1.0% + 5 digits)	
Input Impedance: \geq 10M Ω				

μA AC	600 μA	0.1 μA	± (1.2% + 5 digits)	1000V DC; 750V AC
μA DC			± (1.0% + 2 digits)	
Resistance	600.0 Ω	0.1 Ω	± (1.2% + 2 digits)	1000V DC 750V AC
	6.000k Ω	0.001k Ω	± (1.0% + 2 digits)	
	60.00k Ω	0.01k Ω		
	600.0k Ω	0.1k Ω		
	6.000M Ω	0.001M Ω	± (1.2% + 2 digits)	
	60.00M Ω	0.01M Ω	± (1.5% + 5 digits)	
Continuity	600.0 Ω	0.1 Ω	± (1.2% + 2 digits)	1000V DC; 750V AC
<i>Continuity: Built-in beeper sounds when measured resistance is less than 30Ω. Open Circuit Voltage approx. 1.2V</i>				
Diode	3V	0.001V	Silicon PN junction 0.5 to 0.8V (typically)	1000V DC; 750V AC
<i>Open Circuit Voltage : Approx. 3.3V</i>				
Capacitance (EX650)	99.99nF	0.01 nF	± (4.0% + 25 digits)	1000V DC 750V AC
	999.9nF	0.1 nF	± (4.0% + 5 digits)	
	9.999 μF	0.001 μF		
	99.99 μF	0.01 μF		
	999.9 μF	0.1 μF		
	9.999 mF	0.001 mF	± (10%)	
	59.99 mF	0.01 mF	For reference only	
Capacitance (EX655)	60.00 nF	0.01 nF	± (4.0% + 25 digits)	1000V DC 750V AC
	600.0 nF	0.1 nF	± (4.0% + 5 digits)	
	6.000 μF	0.001 μF		
	60.00 μF	0.01 μF		
	600.0 μF	0.1 μF		
	6000 μF	1 μF	± (10%)	
	60.00 mF	0.01 mF	For reference only	
Frequency (EX655)	10Hz~1MHz	0.01Hz~1kHz	± (0.1% + 3 digits)	1000V DC; 750V AC
Sensitivity: ≤100kHz: 100mVrms ≤input amplitude ≤20Vrms >100kHz~1MHz: 200mVrms ≤input amplitude ≤20Vrms				

TEMP (EX655)	-40~40 °C	1°	± (3.0% + 5 digits)*	1000V DC 750V AC
	40~400 °C		± (2.0% + 5 digits)*	
	100~1000 °C		± (3.0% + 10 digits)*	
	-40~104 °F	1°	± (3.0% + 10 digits)*	
	104~752°F		± (2.0% + 10 digits)*	
	752~1832°F			
<i>*Does not include accuracy of the temperature probe. Accuracy specifications assume surrounding temperature stable to ±1°C. For ambient temperature changes of ±5°C, rated accuracy applies after 2 hours of stabilization time.</i>				
Non-Contact Voltage Detector (NCV)	≥100Vrms; ≤10mm (LED/Buzzer indication)			
<i>The tip of the meter offers the optimum sensitivity</i>				

GENERAL SPECIFICATIONS

Display	6000-count Multi-Function LCD
Polarity	Automatic display of positive and negative polarity
Over-range indication	“OL” or “-OL” is displayed
Conversion rate	3 updates per second
Clamp Sensor Type	Coil induction (EX650); Hall Effect (EX655)
Test position error	Additional error of $\pm 1.0\%$ of reading applies when the conductor under test is not positioned at the center of the clamp head for current measurements
Max. Jaw Opening	30mm diameter
Electromagnetic field influence	Unstable or inaccurate readings may be displayed if there is an electromagnetic field disturbance in the measurement environment
Maximum Voltage	750VAC RMS or 1000V DC maximum applied to any terminal
Low battery indication	 is displayed
Auto Power OFF	After 20 minutes (can be disabled by holding the M (MODE) button while turning the meter ON)
Operating Temperature and Humidity	0~30°C (32~86°F); 80%RH maximum 30~40°C (86~104°F); 75%RH maximum 40~50°C (104~122°F); 45%RH maximum
Storage Temperature and Humidity	-20°~60°C (-4°~140°F); 80%RH maximum (with battery removed)
Operating Altitude	2000m (6562')
Battery power	3 x 1.5V 'AAA' alkaline batteries
Weight	270g (9.5 oz.) Including batteries
Dimensions (W x H x D)	75 x 223 x 40mm (2.9 x 8.7 x 1.6")
Safety Standards	Complies with EN61010-1, EN61010-2-032, and EN61010-2-033 CAT II 1000V, CAT III 600V; Pollution Degree 2
EMC	EN61326-1
Shock and Vibration	Sinusoidal vibration MIL-PRF-28800F (5~55 Hz, 3g max.)
Drop Protection	1m (approx. 3') drop onto hardwood on concrete flooring
For Indoor Use	

Copyright © 2015-2016 FLIR Systems, Inc.

All rights reserved including the right of reproduction in whole or in part in any form
ISO-9001 Certified

www.extech.com