

# NXH25T120L2Q1PG

## Q1 3-Phase TNPC Module

The NXH25T120L2Q1PG/PTG is a case power module containing a three channel T-type neutral-point clamped (TNPC) circuit. Each channel has a two 1200 V, 25 A IGBTs with inverse diodes and two 650 V, 20 A IGBTs with inverse diodes. The module contains an NTC thermistor.

### Features

- Low Package Height
- Compact 82.5 mm x 37.4 mm x 12 mm Package
- Press-fit Pins
- Options with Pre-applied Thermal Interface Material (TIM) and Without Pre-applied TIM
- Thermistor

### Typical Applications

- Solar Inverters
- UPS

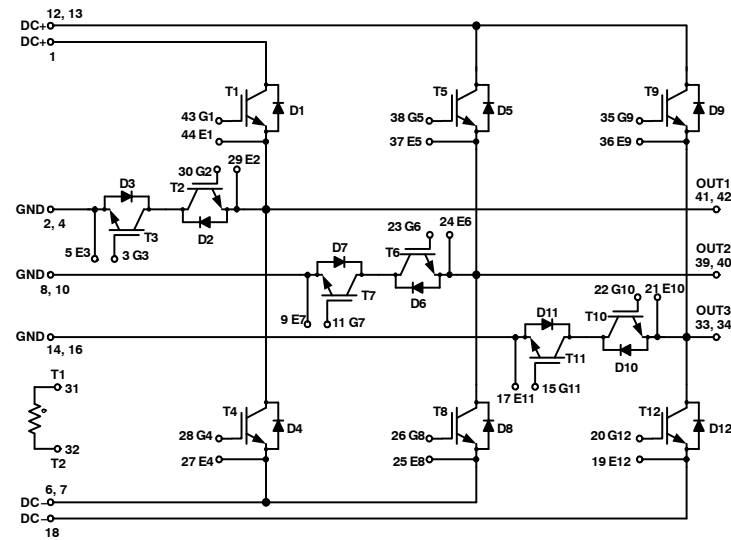
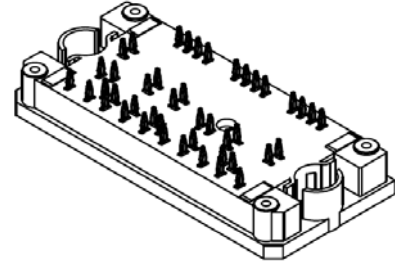

Figure 1. NXH25T120L2Q1PG/PTG Schematic Diagram



**ON Semiconductor®**

[www.onsemi.com](http://www.onsemi.com)



**Q1 3-TNPC  
PRESS FIT  
CASE 180AS**

### DEVICE MARKING

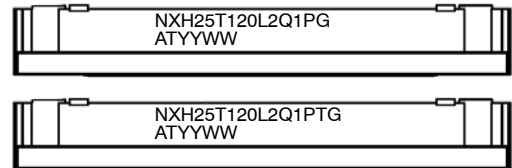

NXH25T120L2Q1P or  
NXH25T120L2Q1PT  
= Specific Device Code  
G = Pb-Free Package  
AT = Assembly & Test Site Code  
YYWW = Year and Work Week Code

### PIN ASSIGNMENTS

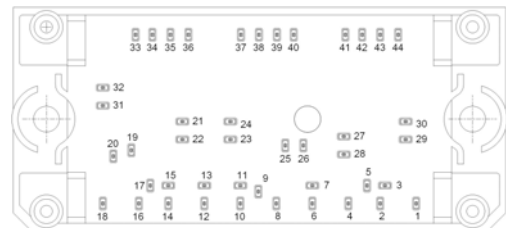

### ORDERING INFORMATION

See detailed ordering and shipping information on page 5 of this data sheet.

# NXH25T120L2Q1PG

**Table 1. MAXIMUM RATINGS** (Note 1)

Rating	Symbol	Value	Unit
<b>HALF BRIDGE IGBT</b>			
Collector–Emitter Voltage	$V_{CES}$	1200	V
Gate–Emitter Voltage	$V_{GE}$	$\pm 20$	V
Continuous Collector Current @ $T_c = 80^\circ\text{C}$ ( $T_J = 175^\circ\text{C}$ )	$I_C$	25	A
Pulsed Collector Current ( $T_J = 175^\circ\text{C}$ )	$I_{Cpulse}$	75	A
Maximum Power Dissipation ( $T_J = 175^\circ\text{C}$ )	$P_{tot}$	81	W
Short Circuit Withstand Time @ $V_{GE} = 15\text{ V}$ , $V_{CE} = 600\text{ V}$ , $T_J \leq 150^\circ\text{C}$	$T_{sc}$	5	$\mu\text{s}$
Minimum Operating Junction Temperature	$T_{JMIN}$	-40	$^\circ\text{C}$
Maximum Operating Junction Temperature	$T_{JMAX}$	150	$^\circ\text{C}$
<b>NEUTRAL POINT IGBT</b>			
Collector–Emitter Voltage	$V_{CES}$	650	V
Gate–Emitter Voltage	$V_{GE}$	$\pm 20$	V
Continuous Collector Current @ $T_c = 80^\circ\text{C}$ ( $T_J = 175^\circ\text{C}$ )	$I_C$	20	A
Pulsed Collector Current ( $T_J = 175^\circ\text{C}$ )	$I_{Cpulse}$	60	A
Maximum Power Dissipation ( $T_J = 175^\circ\text{C}$ )	$P_{tot}$	50	W
Short Circuit Withstand Time @ $V_{GE} = 15\text{ V}$ , $V_{CE} = 400\text{ V}$ , $T_J \leq 150^\circ\text{C}$	$T_{sc}$	5	$\mu\text{s}$
Minimum Operating Junction Temperature	$T_{JMIN}$	-40	$^\circ\text{C}$
Maximum Operating Junction Temperature	$T_{JMAX}$	150	$^\circ\text{C}$
<b>HALF BRIDGE DIODE</b>			
Peak Repetitive Reverse Voltage	$V_{RRM}$	1200	V
Continuous Forward Current @ $T_c = 80^\circ\text{C}$ ( $T_J = 175^\circ\text{C}$ )	$I_F$	15	A
Repetitive Peak Forward Current ( $T_J = 175^\circ\text{C}$ )	$I_{FRM}$	45	A
Maximum Power Dissipation ( $T_J = 175^\circ\text{C}$ )	$P_{tot}$	43	W
Minimum Operating Junction Temperature	$T_{JMIN}$	-40	$^\circ\text{C}$
Maximum Operating Junction Temperature	$T_{JMAX}$	150	$^\circ\text{C}$
<b>NEUTRAL POINT DIODE</b>			
Peak Repetitive Reverse Voltage	$V_{RRM}$	650	V
Continuous Forward Current @ $T_c = 80^\circ\text{C}$ ( $T_J = 175^\circ\text{C}$ )	$I_F$	15	A
Repetitive Peak Forward Current ( $T_J = 175^\circ\text{C}$ )	$I_{FRM}$	45	A
Maximum Power Dissipation ( $T_J = 175^\circ\text{C}$ )	$P_{tot}$	39	W
Minimum Operating Junction Temperature	$T_{JMIN}$	-40	$^\circ\text{C}$
Maximum Operating Junction Temperature	$T_{JMAX}$	150	$^\circ\text{C}$
<b>THERMAL PROPERTIES</b>			
Storage Temperature range	$T_{stg}$	-40 to 125	$^\circ\text{C}$
<b>INSULATION PROPERTIES</b>			
Isolation test voltage, $t = 1\text{ sec}$ , 60Hz	$V_{is}$	3000	$V_{RMS}$
Creepage distance		12.7	mm

Stresses exceeding those listed in the Maximum Ratings table may damage the device. If any of these limits are exceeded, device functionality should not be assumed, damage may occur and reliability may be affected.

1. Refer to ELECTRICAL CHARACTERISTICS, RECOMMENDED OPERATING RANGES and/or APPLICATION INFORMATION for Safe Operating parameters.

**Table 2. RECOMMENDED OPERATING RANGES**

Rating	Symbol	Min	Max	Unit
Module Operating Junction Temperature	$T_J$	-40	150	$^\circ\text{C}$

Functional operation above the stresses listed in the Recommended Operating Ranges is not implied. Extended exposure to stresses beyond the Recommended Operating Ranges limits may affect device reliability.

# NXH25T120L2Q1PG

**Table 3. ELECTRICAL CHARACTERISTICS**  $T_J = 25^\circ\text{C}$  unless otherwise noted

Parameter	Test Conditions	Symbol	Min	Typ	Max	Unit
<b>HALF BRIDGE IGBT CHARACTERISTICS</b>						
Collector–Emitter Cutoff Current	$V_{GE} = 0\text{ V}, V_{CE} = 1200\text{ V}$	$I_{CES}$	–	–	300	$\mu\text{A}$
Collector–Emitter Saturation Voltage	$V_{GE} = 15\text{ V}, I_C = 25\text{ A}, T_J = 25^\circ\text{C}$	$V_{CE(sat)}$	–	1.90	2.50	V
	$V_{GE} = 15\text{ V}, I_C = 25\text{ A}, T_J = 125^\circ\text{C}$		–	1.96	–	
Gate–Emitter Threshold Voltage	$V_{GE} = V_{CE}, I_C = 1.5\text{ mA}$	$V_{GE(TH)}$	4.90	5.49	6.50	V
Gate Leakage Current	$V_{GE} = 20\text{ V}, V_{CE} = 0\text{ V}$	$I_{GES}$	–	–	300	nA
Turn-on Delay Time	$T_J = 25^\circ\text{C}$ $V_{CE} = 350\text{ V}, I_C = 15\text{ A}$ $V_{GE} = \pm 15\text{ V}, R_G = 15\ \Omega$	$t_{d(on)}$	–	59	–	ns
Rise Time		$t_r$	–	26	–	
Turn-off Delay Time		$t_{d(off)}$	–	242	–	
Fall Time		$t_f$	–	52	–	
Turn-on Switching Loss per Pulse		$E_{on}$	–	220	–	
Turn off Switching Loss per Pulse	$E_{off}$	–	240	–		
Turn-on Delay Time	$T_J = 125^\circ\text{C}$ $V_{CE} = 350\text{ V}, I_C = 15\text{ A}$ $V_{GE} = \pm 15\text{ V}, R_G = 15\ \Omega$	$t_{d(on)}$	–	48	–	ns
Rise Time		$t_r$	–	29	–	
Turn-off Delay Time		$t_{d(off)}$	–	293	–	
Fall Time		$t_f$	–	258	–	
Turn-on Switching Loss per Pulse		$E_{on}$	–	400	–	
Turn off Switching Loss per Pulse	$E_{off}$	–	710	–		
Input Capacitance	$V_{CE} = 20\text{ V}, V_{GE} = 0\text{ V}, f = 10\text{ kHz}$	$C_{ies}$	–	8502	–	pF
Output Capacitance		$C_{oes}$	–	187	–	
Reverse Transfer Capacitance		$C_{res}$	–	154	–	
Total Gate Charge	$V_{CE} = 600\text{ V}, I_C = 25\text{ A}, V_{GE} = \pm 15\text{ V}$	$Q_g$	–	352	–	nC
Thermal Resistance – chip-to–heatsink	Thermal grease, Thickness $\leq 2.25\text{ Mil}$ , $\lambda = 2.9\text{ W/mK}$	$R_{thJH}$	–	1.17	–	$^\circ\text{C/W}$

### NEUTRAL POINT DIODE CHARACTERISTICS

Diode Forward Voltage	$I_F = 15\text{ A}, T_J = 25^\circ\text{C}$	$V_F$	–	2.43	–	V
	$I_F = 15\text{ A}, T_J = 125^\circ\text{C}$		–	1.60	–	
Combined IGBT + Diode Voltage Drop	$I_F = 15\text{ A}, T_J = 25^\circ\text{C}$	$V_{DT}$	–	3.76	4.60	V
Reverse Recovery Time	$T_J = 25^\circ\text{C}$ $V_{CE} = 350\text{ V}, I_C = 15\text{ A}$ $V_{GE} = \pm 15\text{ V}, R_G = 15\ \Omega$	$t_{rr}$	–	59	–	ns
Reverse Recovery Charge		$Q_{rr}$	–	0.21	–	$\mu\text{C}$
Peak Reverse Recovery Current		$I_{RRM}$	–	7	–	A
Peak Rate of Fall of Recovery Current		$di/dt$	–	106	–	$\text{A}/\mu\text{s}$
Reverse Recovery Energy		$E_{rr}$	–	40	–	$\mu\text{J}$
Reverse Recovery Time	$T_J = 125^\circ\text{C}$ $V_{CE} = 350\text{ V}, I_C = 15\text{ A}$ $V_{GE} = \pm 15\text{ V}, R_G = 15\ \Omega$	$t_{rr}$	–	67	–	ns
Reverse Recovery Charge		$Q_{rr}$	–	0.69	–	$\mu\text{C}$
Peak Reverse Recovery Current		$I_{RRM}$	–	19	–	A
Peak Rate of Fall of Recovery Current		$di/dt$	–	451	–	$\text{A}/\mu\text{s}$
Reverse Recovery Energy		$E_{rr}$	–	100	–	$\mu\text{J}$
Thermal Resistance – chip-to–heatsink	Thermal grease, Thickness $\leq 2.25\text{ Mil}$ , $\lambda = 2.9\text{ W/mK}$	$R_{thJH}$	–	2.45	–	$^\circ\text{C/W}$

# NXH25T120L2Q1PG

**Table 3. ELECTRICAL CHARACTERISTICS**  $T_J = 25^\circ\text{C}$  unless otherwise noted

Parameter	Test Conditions	Symbol	Min	Typ	Max	Unit
<b>NEUTRAL POINT IGBT CHARACTERISTICS</b>						
Collector–Emitter Cutoff Current	$V_{GE} = 0\text{ V}, V_{CE} = 650\text{ V}$	$I_{CES}$	–	–	200	$\mu\text{A}$
Collector–Emitter Saturation Voltage	$V_{GE} = 15\text{ V}, I_C = 20\text{ A}, T_J = 25^\circ\text{C}$	$V_{CE(sat)}$	–	1.49	–	V
	$V_{GE} = 15\text{ V}, I_C = 20\text{ A}, T_J = 125^\circ\text{C}$		–	1.61	–	
Gate–Emitter Threshold Voltage	$V_{GE} = V_{CE}, I_C = 1.65\text{ mA}$	$V_{GE(TH)}$	4.70	5.68	6.50	V
Gate Leakage Current	$V_{GE} = 20\text{ V}, V_{CE} = 0\text{ V}$	$I_{GES}$	–	–	200	nA
Turn-on Delay Time	$T_J = 25^\circ\text{C}$ $V_{CE} = 350\text{ V}, I_C = 15\text{ A}$ $V_{GE} = \pm 15\text{ V}, R_G = 15\ \Omega$	$t_{d(on)}$	–	33	–	ns
Rise Time		$t_r$	–	18	–	
Turn-off Delay Time		$t_{d(off)}$	–	126	–	
Fall Time		$t_f$	–	43	–	
Turn-on Switching Loss per Pulse		$E_{on}$	–	250	–	
Turn off Switching Loss per Pulse	$E_{off}$	–	180	–		
Turn-on Delay Time	$T_J = 125^\circ\text{C}$ $V_{CE} = 350\text{ V}, I_C = 15\text{ A}$ $V_{GE} = \pm 15\text{ V}, R_G = 15\ \Omega$	$t_{d(on)}$	–	31	–	ns
Rise Time		$t_r$	–	19	–	
Turn-off Delay Time		$t_{d(off)}$	–	138	–	
Fall Time		$t_f$	–	72	–	
Turn-on Switching Loss per Pulse		$E_{on}$	–	390	–	
Turn off Switching Loss per Pulse	$E_{off}$	–	300	–		
Input Capacitance	$V_{CE} = 20\text{ V}, V_{GE} = 0\text{ V}, f = 10\text{ kHz}$	$C_{ies}$	–	3837	–	pF
Output Capacitance		$C_{oes}$	–	127	–	
Reverse Transfer Capacitance		$C_{res}$	–	104	–	
Total Gate Charge	$V_{CE} = 480\text{ V}, I_C = 20\text{ A}, V_{GE} = \pm 15\text{ V}$	$Q_g$	–	166	–	nC
Thermal Resistance – chip-to–heatsink	Thermal grease, Thickness $\leq 2.25\text{ Mil}$ , $\lambda = 2.9\text{ W/mK}$	$R_{thJH}$	–	1.90	–	$^\circ\text{C/W}$

### HALF BRIDGE DIODE CHARACTERISTICS

Diode Forward Voltage	$I_F = 15\text{ A}, T_J = 25^\circ\text{C}$	$V_F$	–	2.47	3	V
	$I_F = 15\text{ A}, T_J = 125^\circ\text{C}$		–	1.97	–	
Reverse Recovery Time	$T_J = 25^\circ\text{C}$ $V_{CE} = 350\text{ V}, I_C = 15\text{ A}$ $V_{GE} = \pm 15\text{ V}, R_G = 15\ \Omega$	$t_{rr}$	–	63	–	ns
Reverse Recovery Charge		$Q_{rr}$	–	0.45	–	$\mu\text{C}$
Peak Reverse Recovery Current		$I_{RRM}$	–	17	–	A
Peak Rate of Fall of Recovery Current		$di/dt$	–	313	–	$\text{A}/\mu\text{s}$
Reverse Recovery Energy		$E_{rr}$	–	70	–	$\mu\text{J}$
Reverse Recovery Time	$T_J = 125^\circ\text{C}$ $V_{CE} = 350\text{ V}, I_C = 15\text{ A}$ $V_{GE} = \pm 15\text{ V}, R_G = 15\ \Omega$	$t_{rr}$	–	233	–	ns
Reverse Recovery Charge		$Q_{rr}$	–	1.55	–	$\mu\text{C}$
Peak Reverse Recovery Current		$I_{RRM}$	–	22	–	A
Peak Rate of Fall of Recovery Current		$di/dt$	–	76	–	$\text{A}/\mu\text{s}$
Reverse Recovery Energy		$E_{rr}$	–	360	–	$\mu\text{J}$
Thermal Resistance – chip-to–heatsink	Thermal grease, Thickness $\leq 2.25\text{ Mil}$ , $\lambda = 2.9\text{ W/mK}$	$R_{thJH}$	–	2.21	–	$^\circ\text{C/W}$

# NXH25T120L2Q1PG

**Table 3. ELECTRICAL CHARACTERISTICS**  $T_J = 25^\circ\text{C}$  unless otherwise noted

Parameter	Test Conditions	Symbol	Min	Typ	Max	Unit
<b>THERMISTOR CHARACTERISTICS</b>						
Nominal resistance	$T = 25^\circ\text{C}$	$R_{25}$	-	22	-	$k\Omega$
Nominal resistance	$T = 100^\circ\text{C}$	$R_{100}$	-	1468	-	$\Omega$
Deviation of $R_{25}$		$\Delta R/R$	-5		5	%
Power dissipation		$P_D$	-	200	-	mW
Power dissipation constant			-	2	-	mW/K
B-value	$B(25/50)$ , tolerance $\pm 3\%$		-	3950	-	K
B-value	$B(25/100)$ , tolerance $\pm 3\%$		-	3998	-	K

## ORDERING INFORMATION

Orderable Part Number	Marking	Package	Shipping
NXH25T120L2Q1PG	NXH25T120L2Q1PG	Q1 3-Phase TNPC – Case 180AS Press-fit Pins (Pb – Free)	21 Units / Blister Tray
NXH25T120L2Q1PTG	NXH25T120L2Q1PTG	Q1 3-Phase TNPC – Case 180AS Press-fit Pins with pre-applied thermal interface material (TIM) (Pb – Free)	21 Units / Blister Tray

# NXH25T120L2Q1PG

## TYPICAL CHARACTERISTICS – HALF BRIDGE IGBT AND DIODE

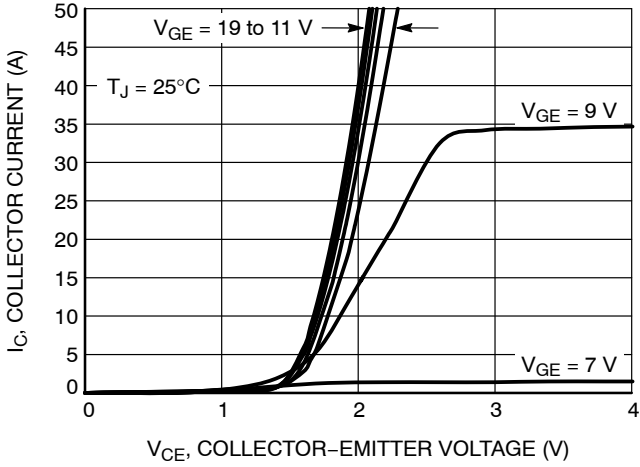

Figure 2. Typical Output Characteristics

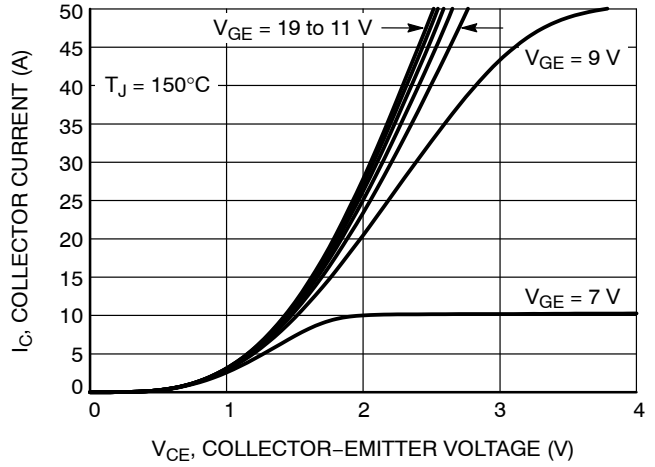

Figure 3. Typical Output Characteristics

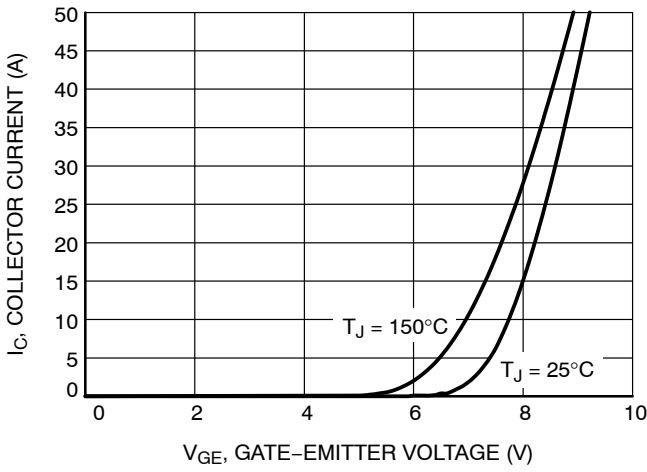

Figure 4. Typical Transfer Characteristics

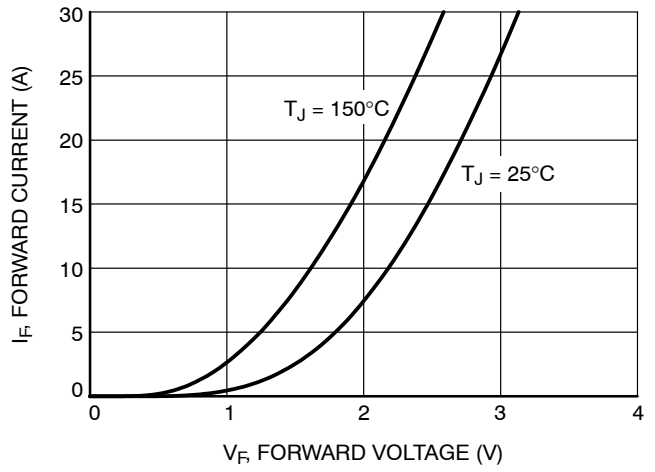

Figure 5. Diode Forward Characteristics

# NXH25T120L2Q1PG

## TYPICAL CHARACTERISTICS – HALF BRIDGE IGBT AND DIODE

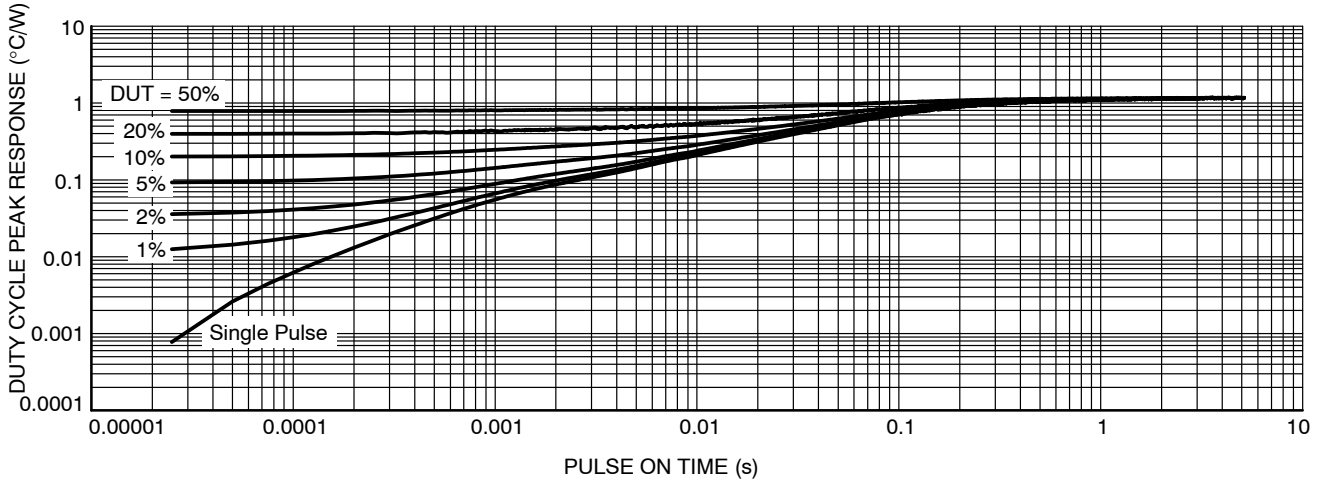

Figure 6. Transient Thermal Impedance (Half Bridge IGBT)

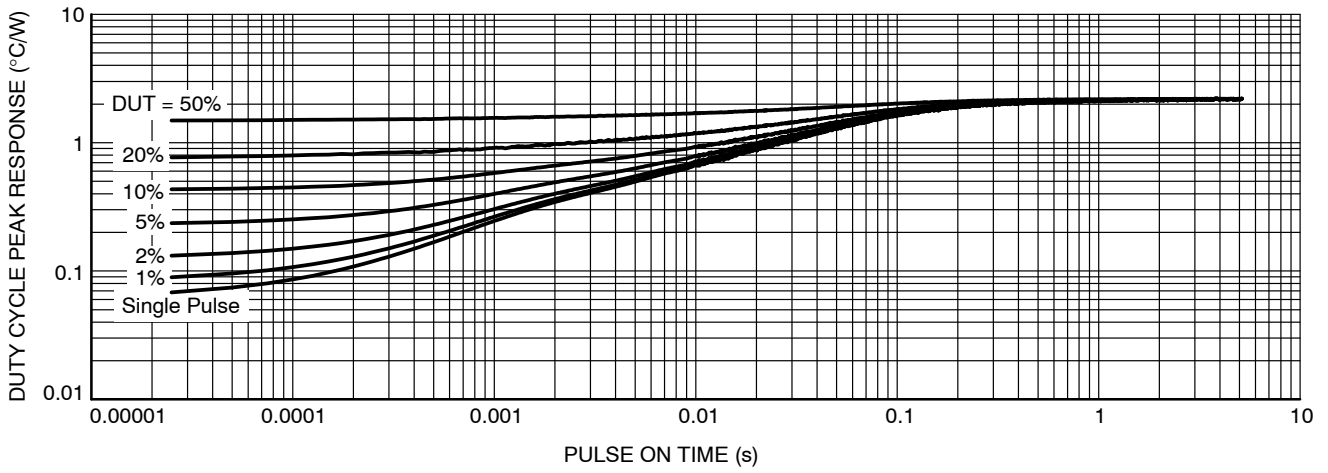

Figure 7. Transient Thermal Impedance (Half Bridge Diode)

TYPICAL CHARACTERISTICS – HALF BRIDGE IGBT AND DIODE

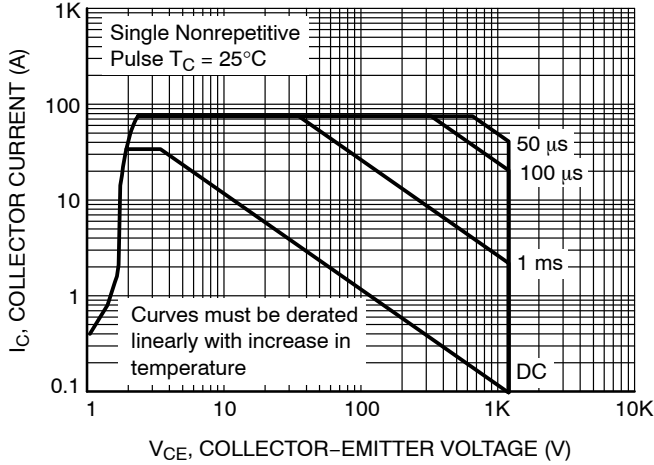

Figure 8. FBSOA

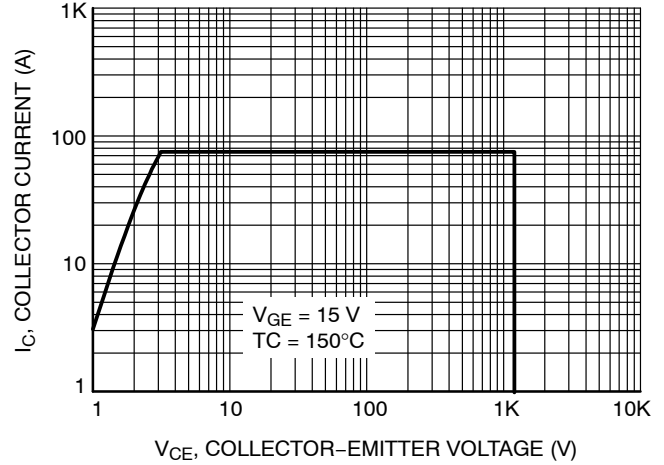

Figure 9. RBSOA

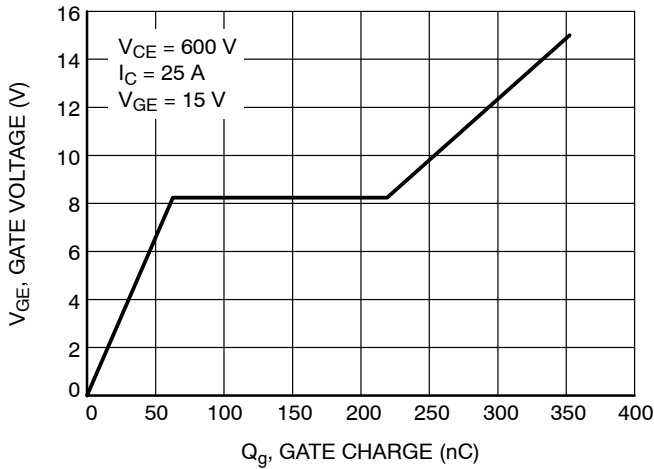

Figure 10. Gate Voltage vs. Gate Charge



TYPICAL CHARACTERISTICS – NEUTRAL POINT IGBT AND DIODE

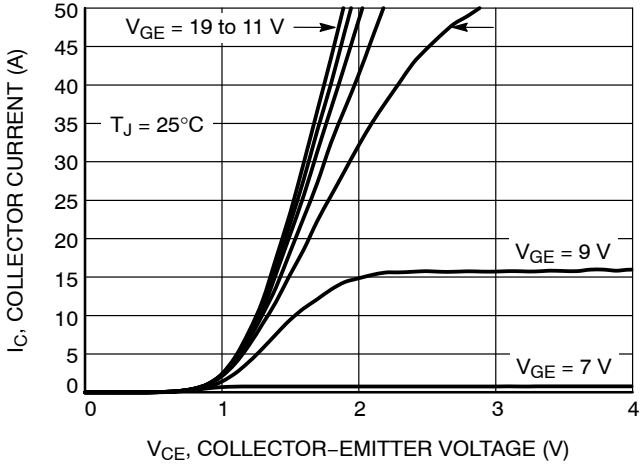

Figure 11. Typical Output Characteristics

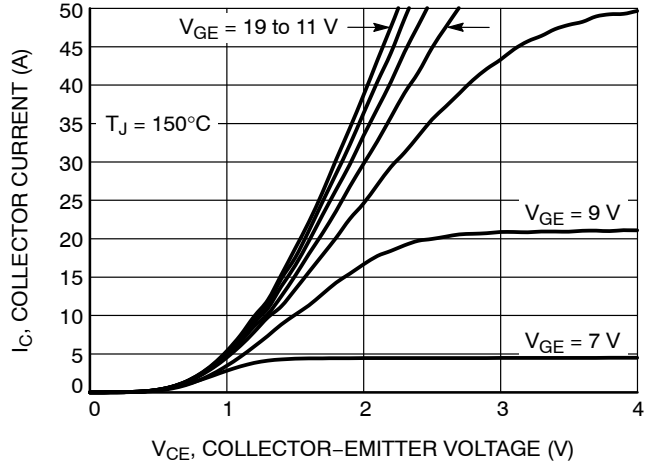

Figure 12. Typical Output Characteristics

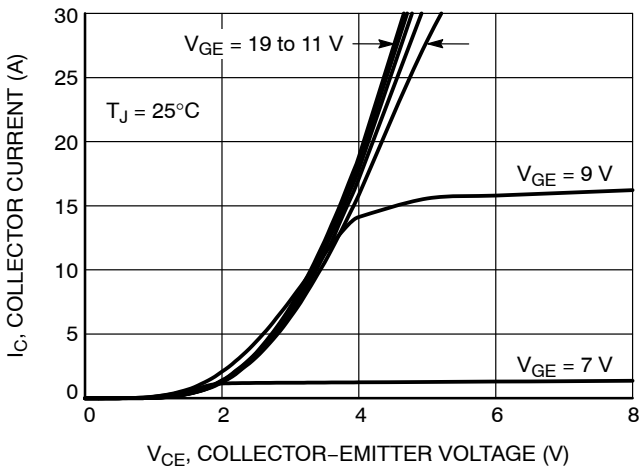

Figure 13. Typical Output Characteristics (Ic vs. Vce)

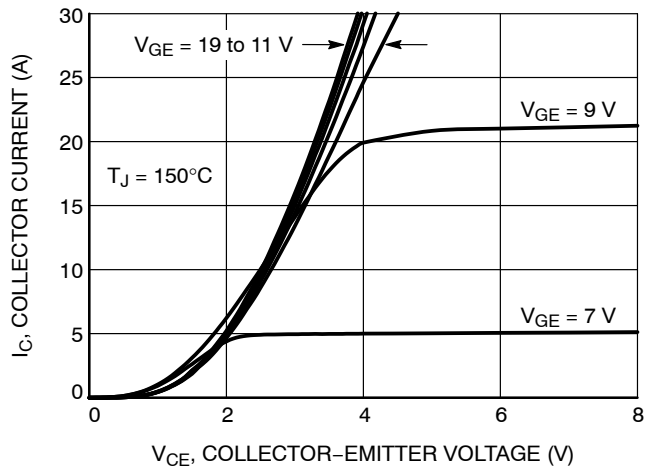

Figure 14. Typical Output Characteristics (Ic vs. Vce)

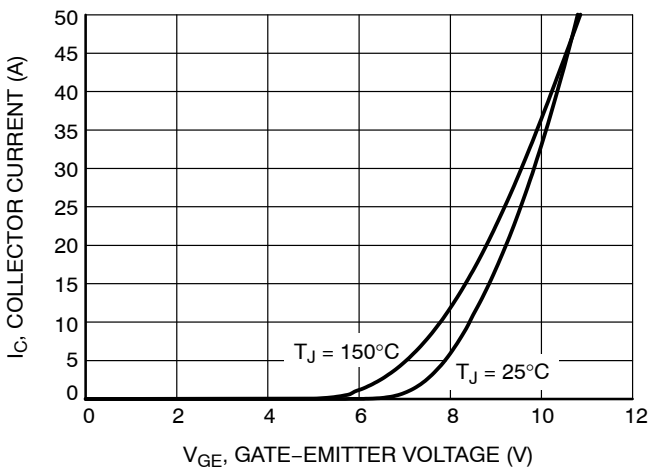

Figure 15. Typical Transfer Characteristics

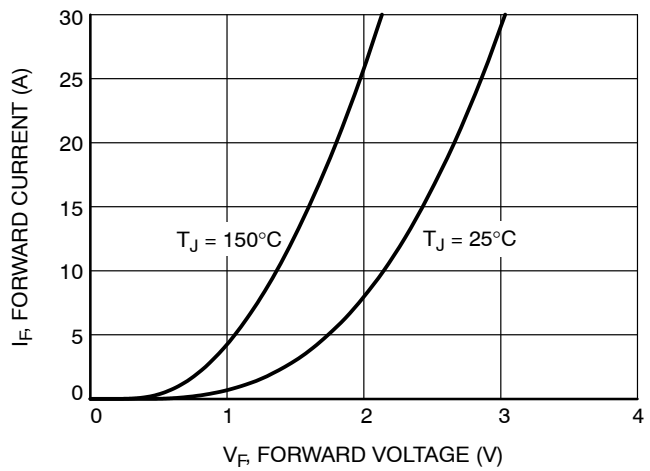

Figure 16. Diode Forward Characteristics

# NXH25T120L2Q1PG

## TYPICAL CHARACTERISTICS – NEUTRAL POINT IGBT AND DIODE

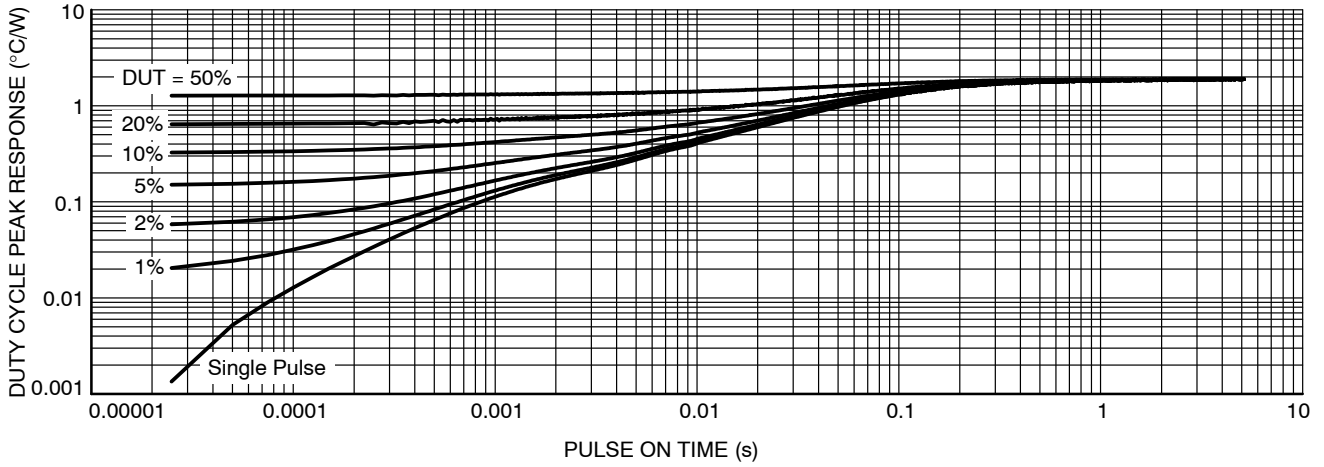

Figure 17. Transient Thermal Impedance (Neutral Point IGBT)

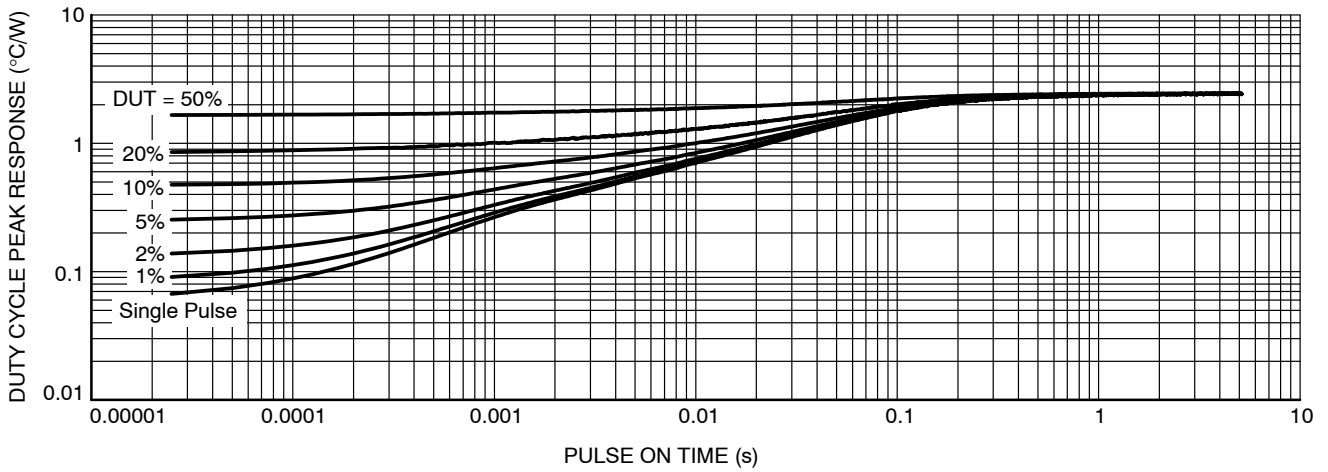

Figure 18. Transient Thermal Impedance (Neutral Point Diode)

TYPICAL CHARACTERISTICS – NEUTRAL POINT IGBT AND DIODE

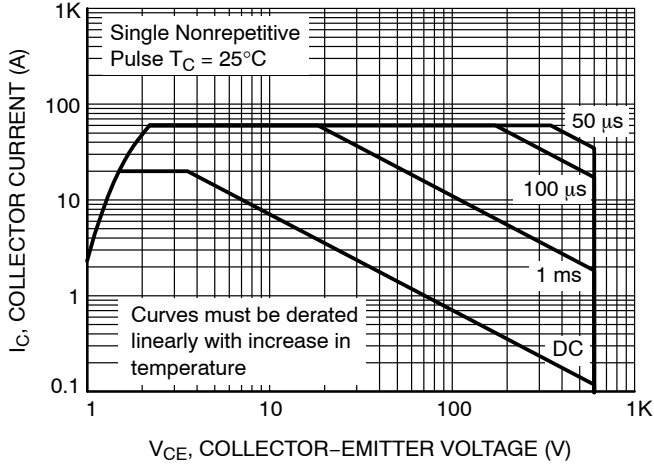

Figure 19. FBSOA

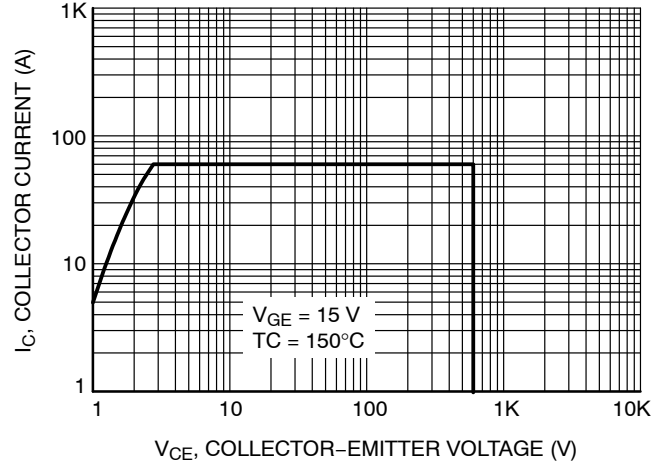

Figure 20. RBSOA

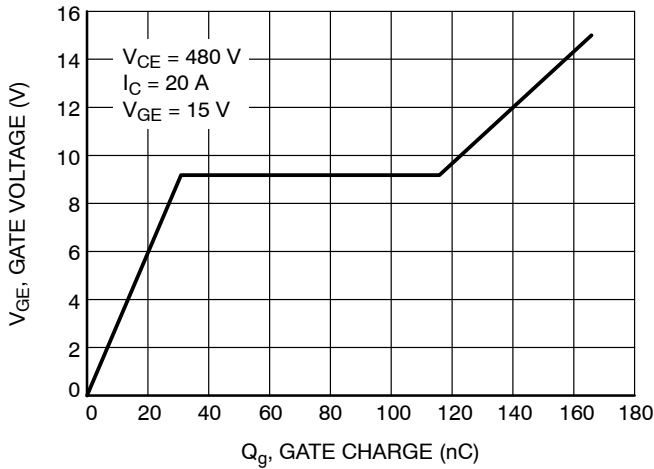

Figure 21. Gate Voltage vs. Gate Charge

# NXH25T120L2Q1PG

## TYPICAL CHARACTERISTICS – HALF BRIDGE IGBT COMUTATES NEUTRAL POINT DIODE

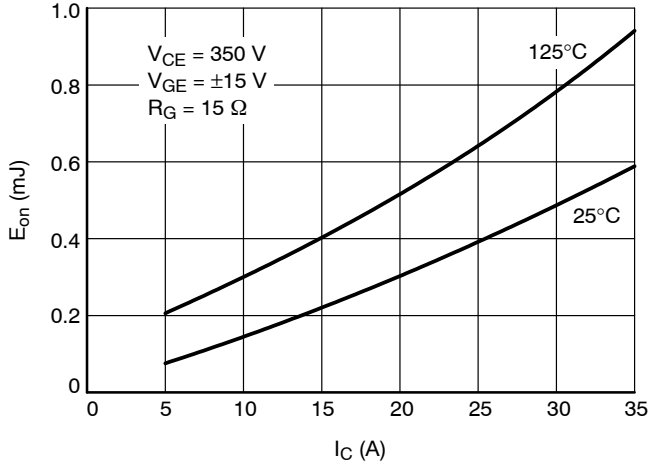

Figure 22. Typical Switching Loss  $E_{on}$  vs.  $I_C$

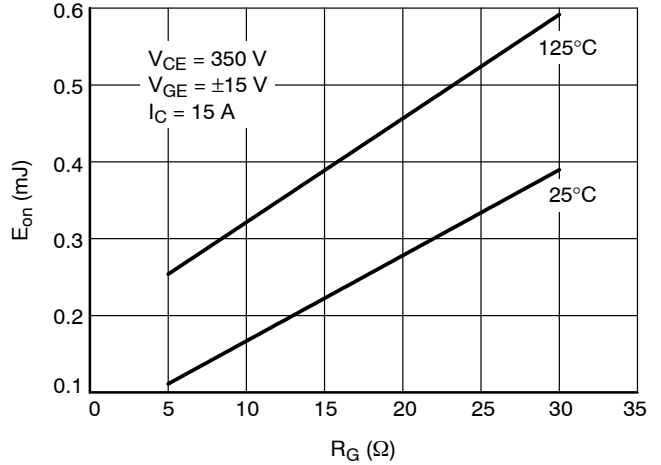

Figure 23. Typical Switching Loss  $E_{on}$  vs.  $R_G$

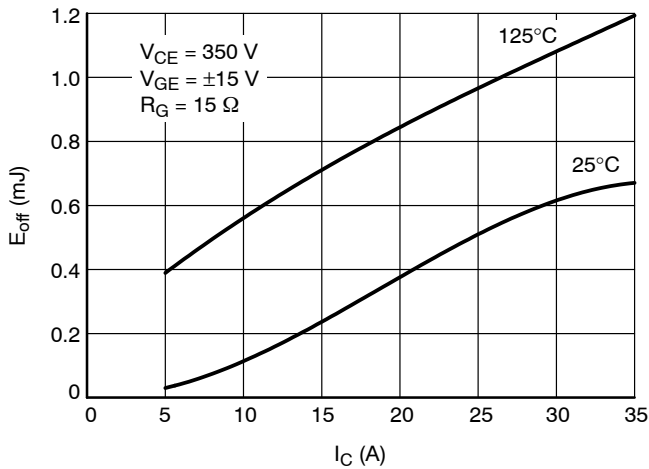

Figure 24. Typical Switching Loss  $E_{off}$  vs.  $I_C$

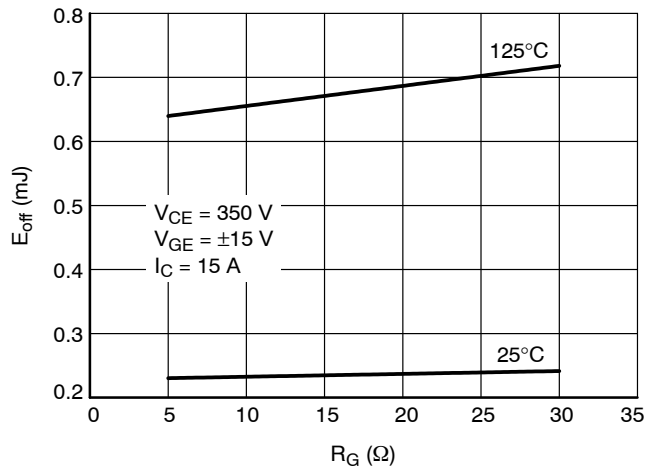

Figure 25. Typical Switching Loss  $E_{off}$  vs.  $R_G$

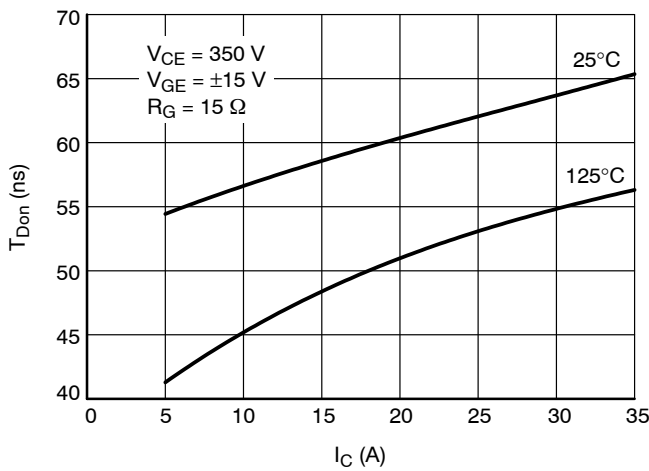

Figure 26. Typical Switching Time  $T_{Don}$  vs.  $I_C$

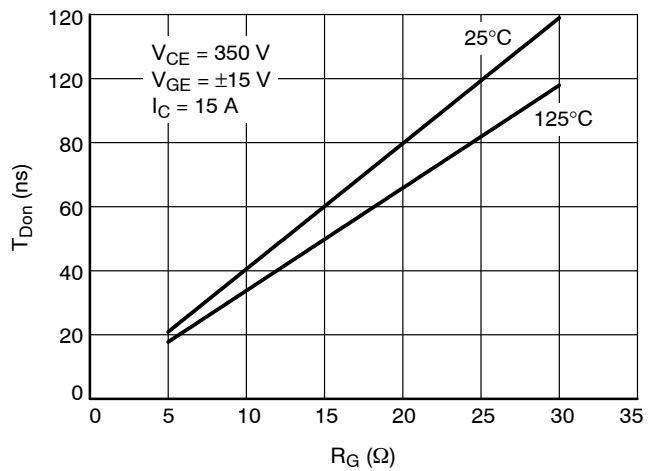

Figure 27. Typical Switching Time  $T_{Don}$  vs.  $R_G$

# NXH25T120L2Q1PG

## TYPICAL CHARACTERISTICS – HALF BRIDGE IGBT COMUTATES NEUTRAL POINT DIODE

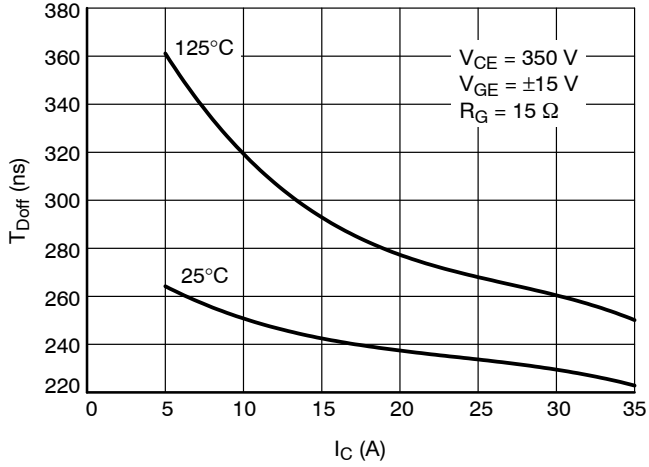

Figure 28. Typical Switching Time  $T_{Doff}$  vs.  $I_C$

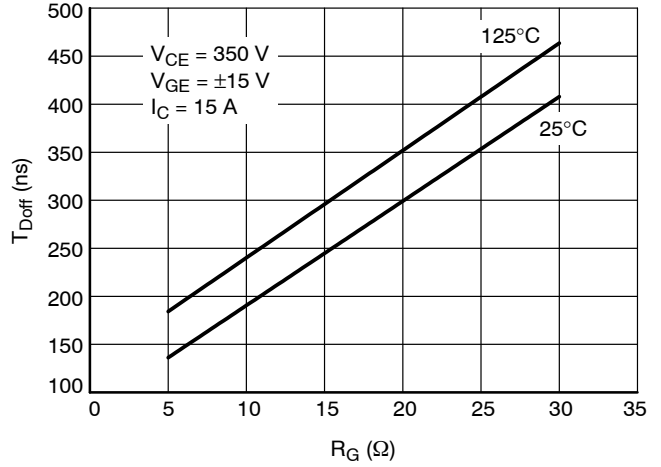

Figure 29. Typical Switching Time  $T_{Doff}$  vs.  $R_G$

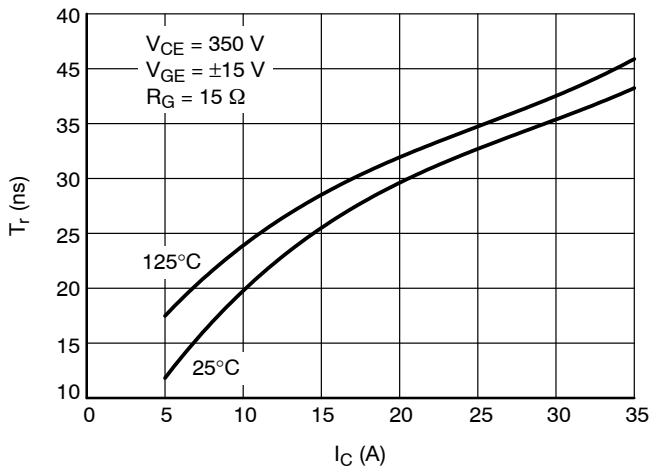

Figure 30. Typical Switching Time  $T_r$  vs.  $I_C$

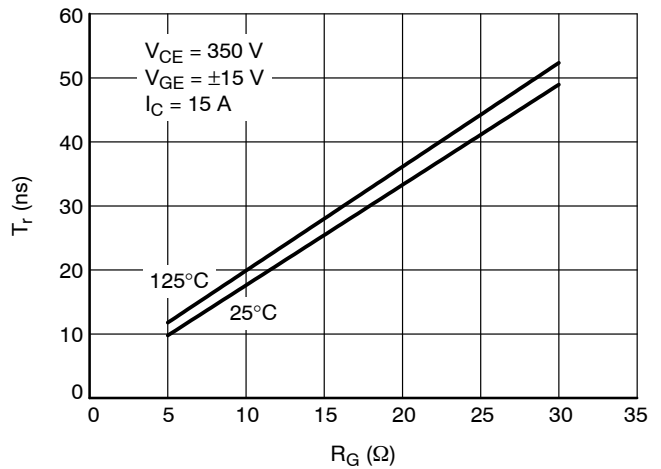

Figure 31. Typical Switching Time  $T_r$  vs.  $R_G$

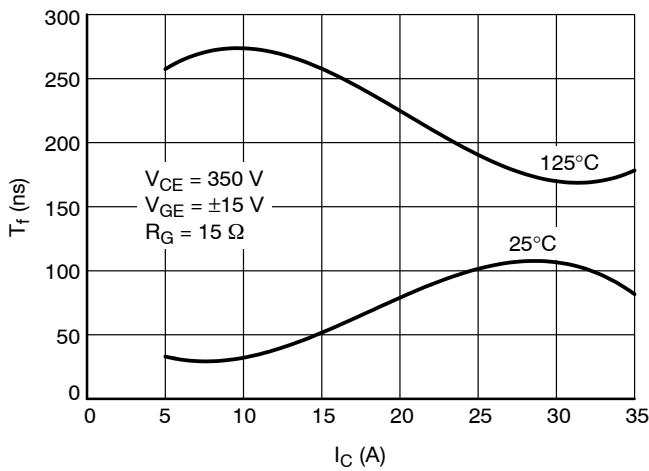

Figure 32. Typical Switching Time  $T_f$  vs.  $I_C$

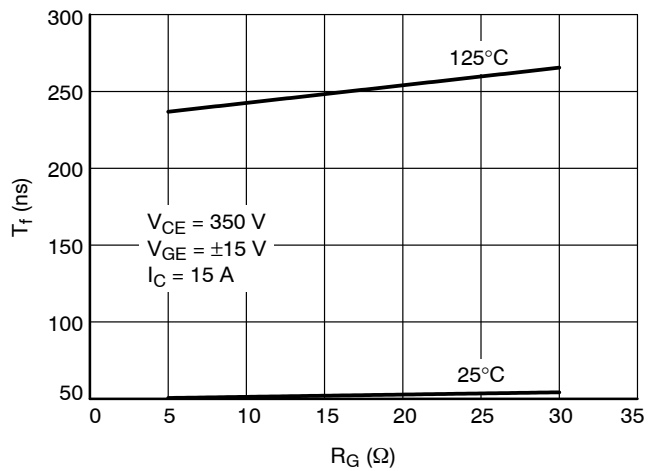

Figure 33. Typical Switching Time  $T_f$  vs.  $R_G$

TYPICAL CHARACTERISTICS – HALF BRIDGE IGBT COMUTATES NEUTRAL POINT DIODE

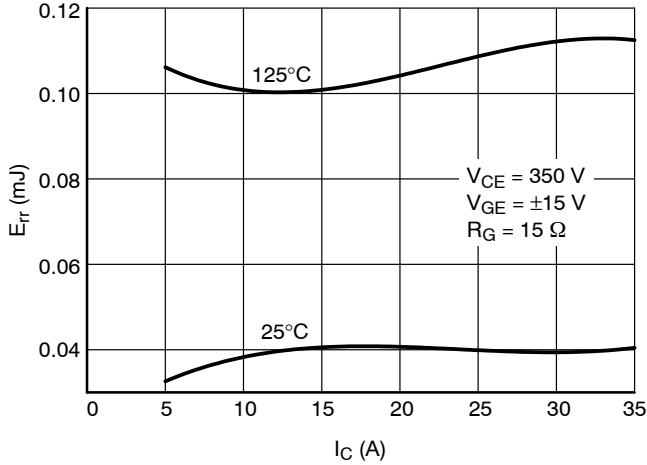

Figure 34. Typical Reverse Recovery Energy vs.  $I_C$

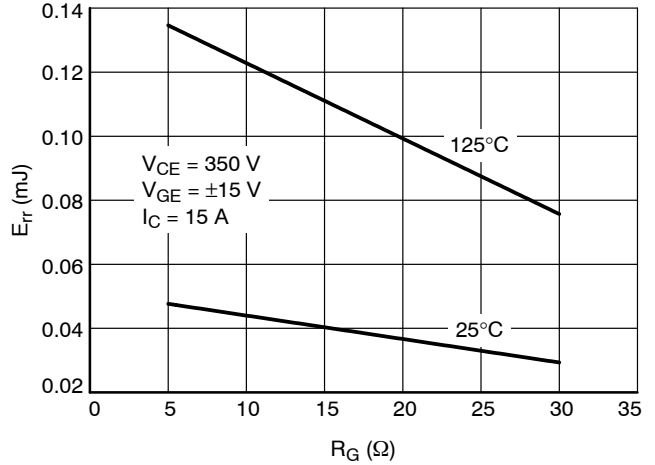

Figure 35. Typical Reverse Recovery Energy vs.  $R_G$

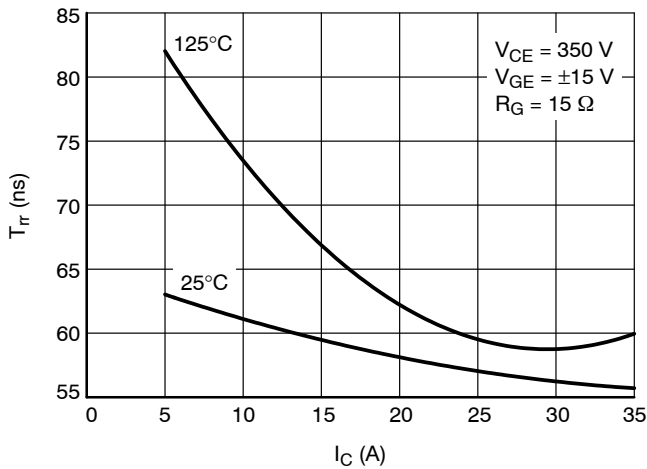

Figure 36. Typical Reverse Recovery Time vs.  $I_C$

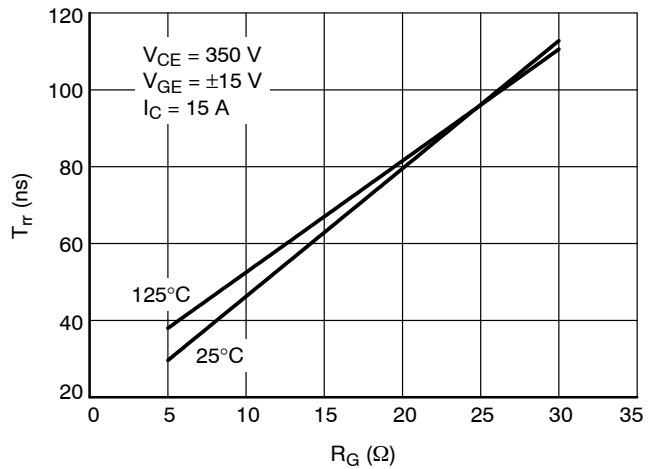

Figure 37. Typical Reverse Recovery Time vs.  $R_G$

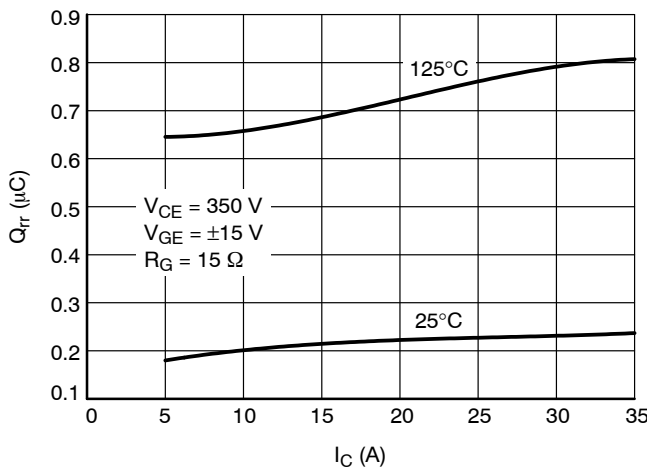

Figure 38. Typical Reverse Recovery Charge vs.  $I_C$

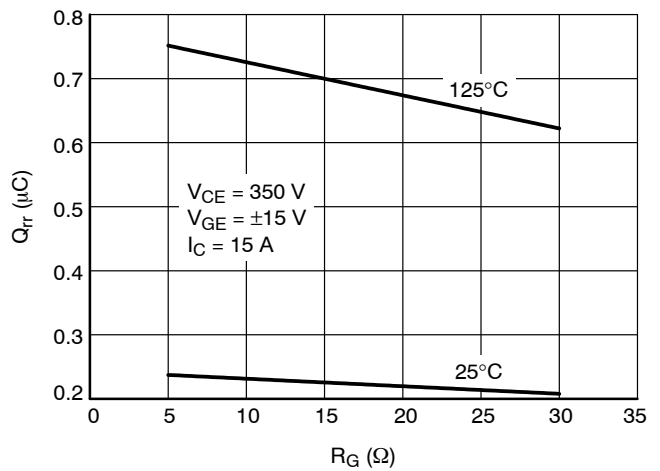

Figure 39. Typical Reverse Recovery Charge vs.  $R_G$

# NXH25T120L2Q1PG

## TYPICAL CHARACTERISTICS – HALF BRIDGE IGBT COMUTATES NEUTRAL POINT DIODE

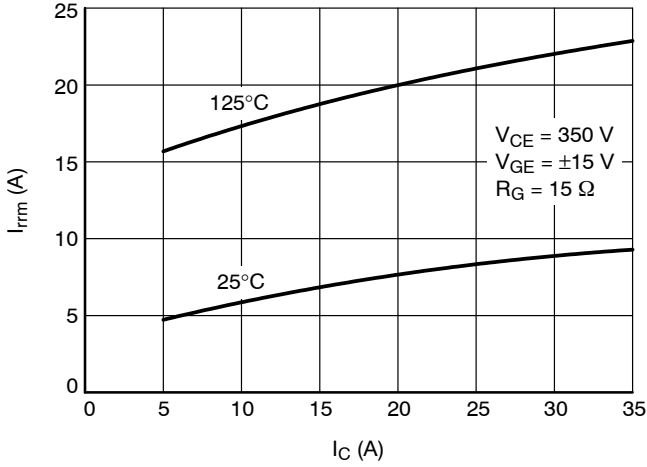

Figure 40. Typical Reverse Recovery Current vs.  $I_C$

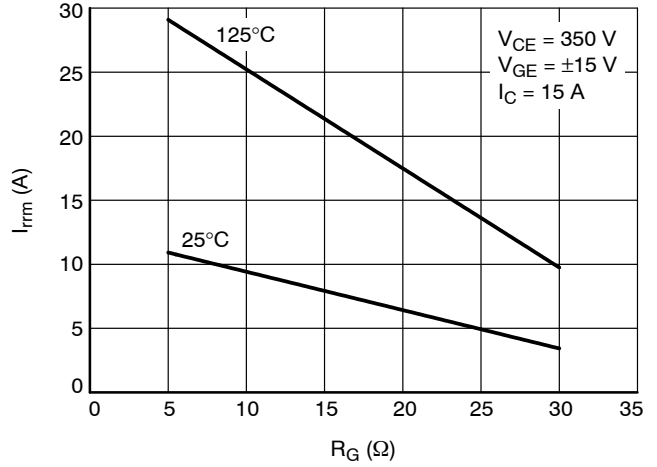

Figure 41. Typical Reverse Recovery Current vs.  $R_G$

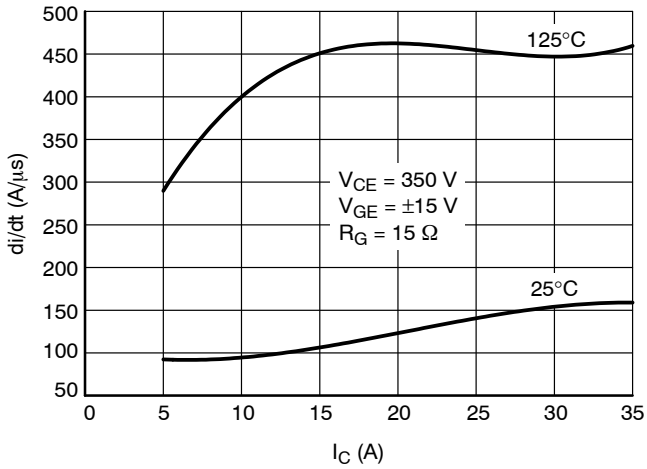

Figure 42. Typical  $di/dt$  vs.  $I_C$

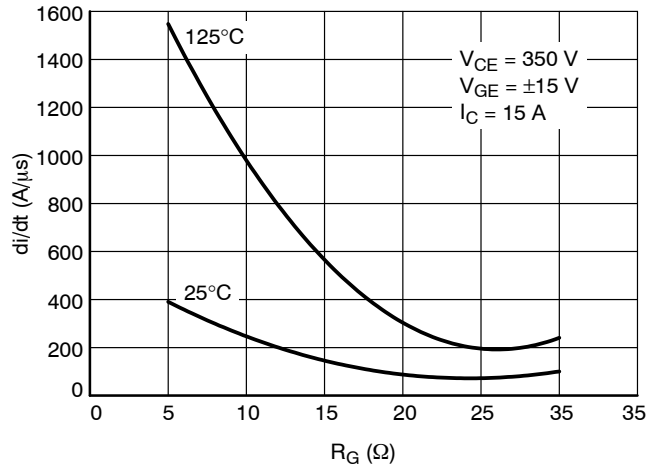

Figure 43. Typical  $di/dt$  vs.  $R_G$

TYPICAL CHARACTERISTICS – NEUTRAL POINT IGBT COMUTATES HALF BRIDGE DIODE

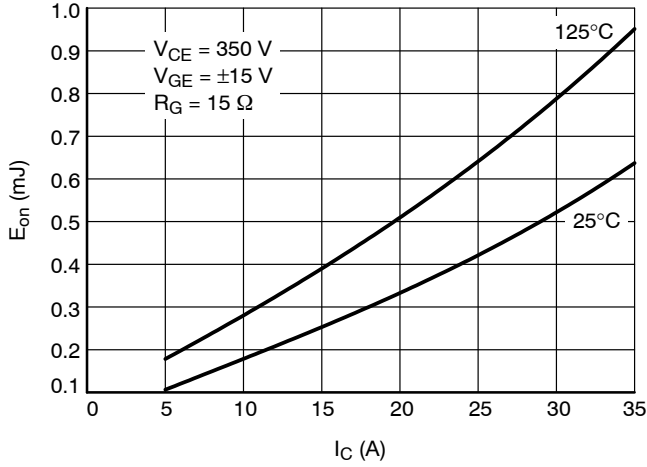

Figure 44. Typical Switching Energy  $E_{on}$  vs.  $I_C$

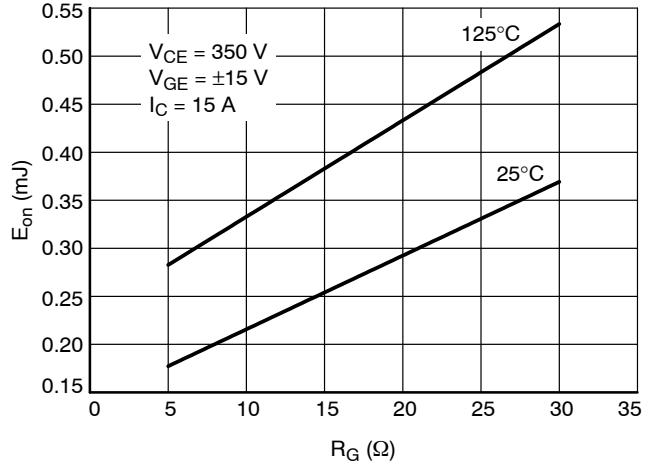

Figure 45. Typical Switching Energy  $E_{on}$  vs.  $R_G$

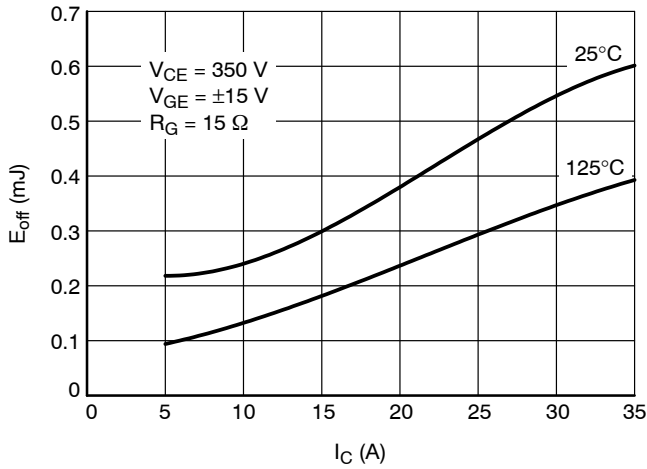

Figure 46. Typical Switching Energy  $E_{off}$  vs.  $I_C$

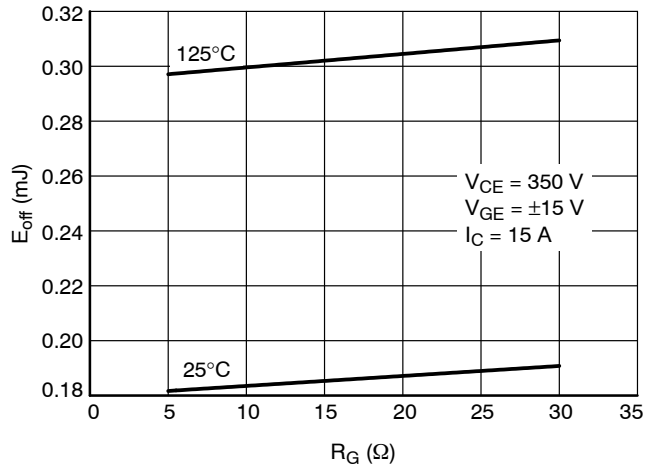

Figure 47. Typical Switching Energy  $E_{off}$  vs.  $R_G$

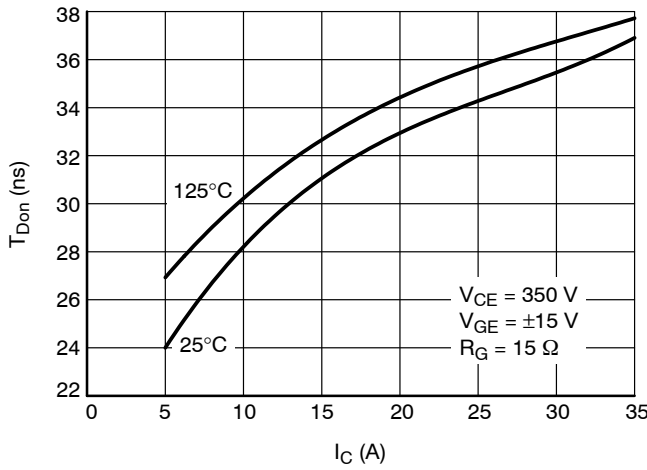

Figure 48. Typical Switching Time  $T_{Don}$  vs.  $I_C$

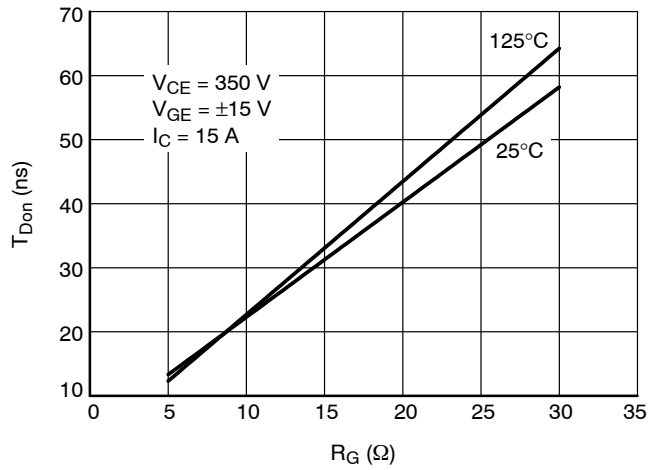

Figure 49. Typical Switching Time  $T_{Don}$  vs.  $R_G$



# NXH25T120L2Q1PG

## TYPICAL CHARACTERISTICS – NEUTRAL POINT IGBT COMUTATES HALF BRIDGE DIODE

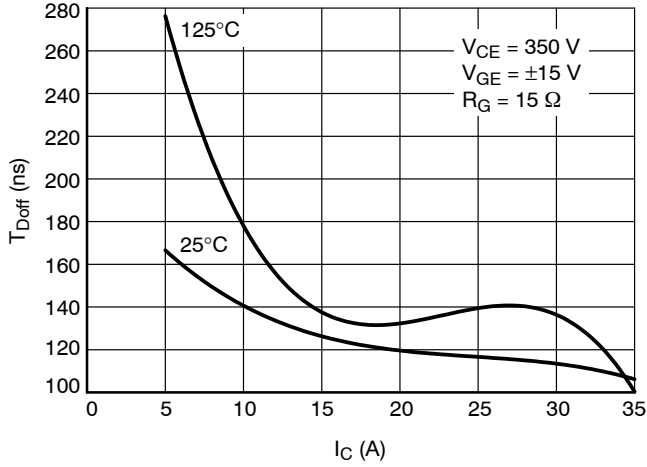

Figure 50. Typical Switching Time  $T_{Doff}$  vs.  $I_C$

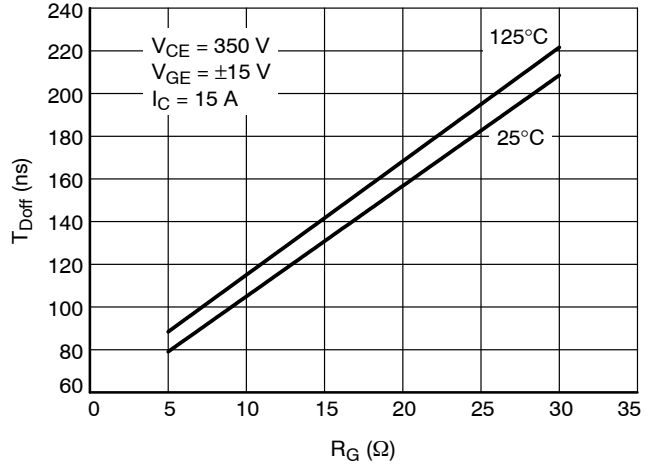

Figure 51. Typical Switching Time  $T_{Doff}$  vs.  $R_G$

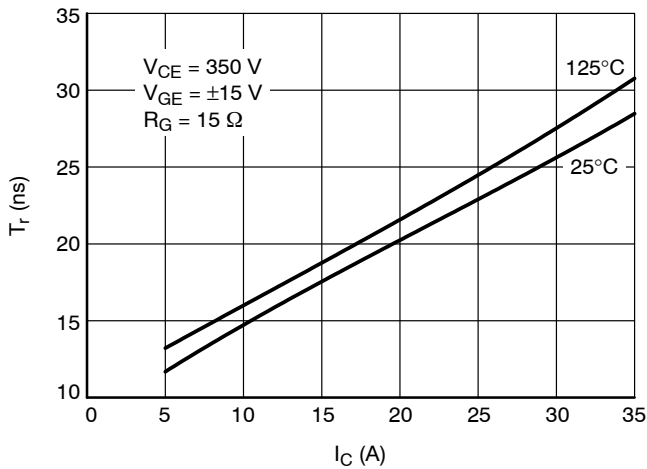

Figure 52. Typical Switching Time  $T_r$  vs.  $I_C$

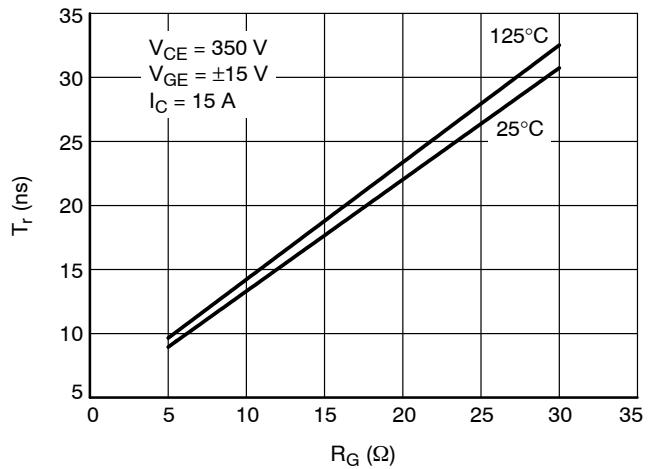

Figure 53. Typical Switching Time  $T_r$  vs.  $R_G$

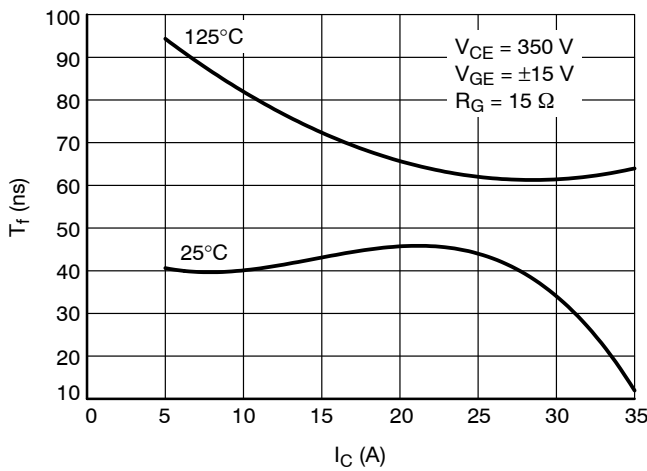

Figure 54. Typical Switching Time  $T_f$  vs.  $I_C$

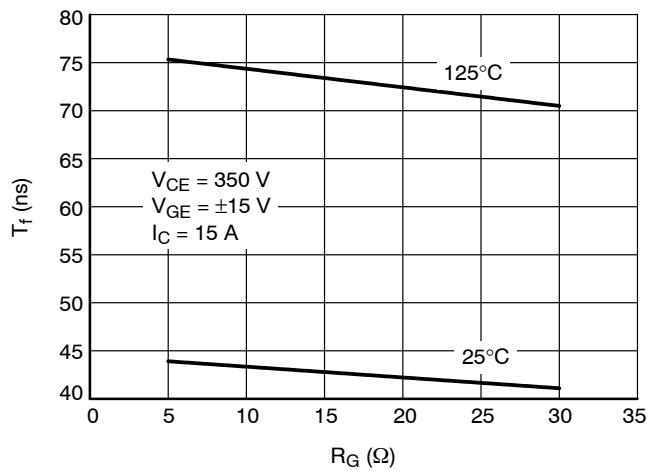

Figure 55. Typical Switching Time  $T_f$  vs.  $R_G$

TYPICAL CHARACTERISTICS – NEUTRAL POINT IGBT COMUTATES HALF BRIDGE DIODE

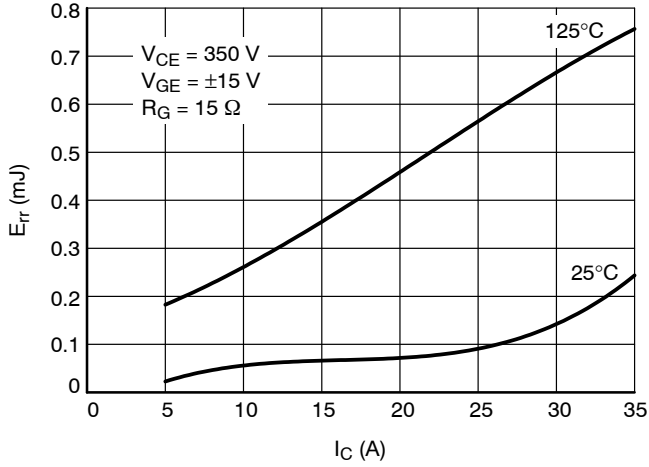

Figure 56. Typical Reverse Recovery Energy vs.  $I_C$

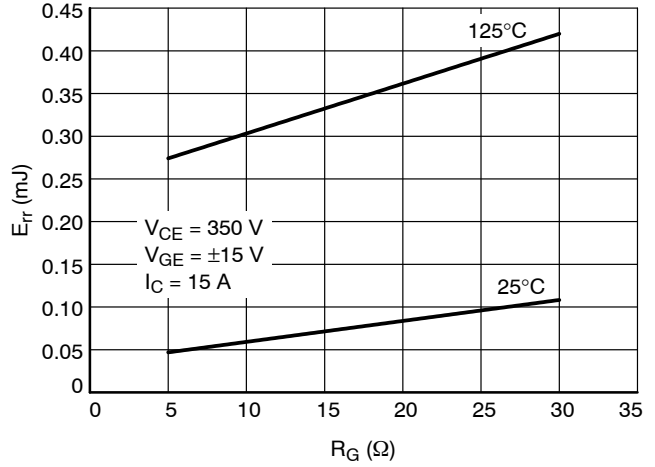

Figure 57. Typical Reverse Recovery Energy vs.  $R_G$

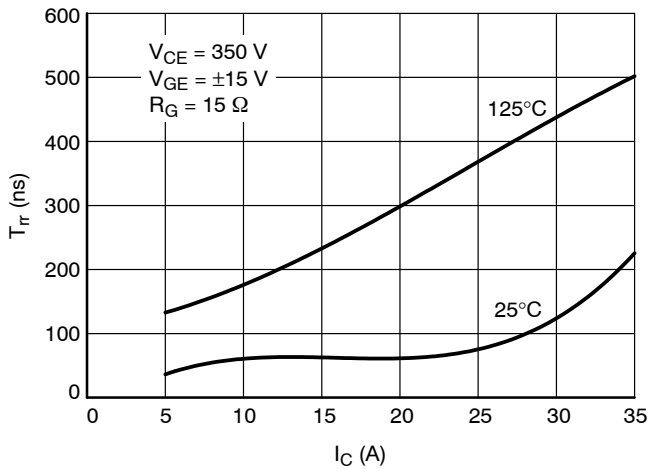

Figure 58. Typical Reverse Recovery Time vs.  $I_C$

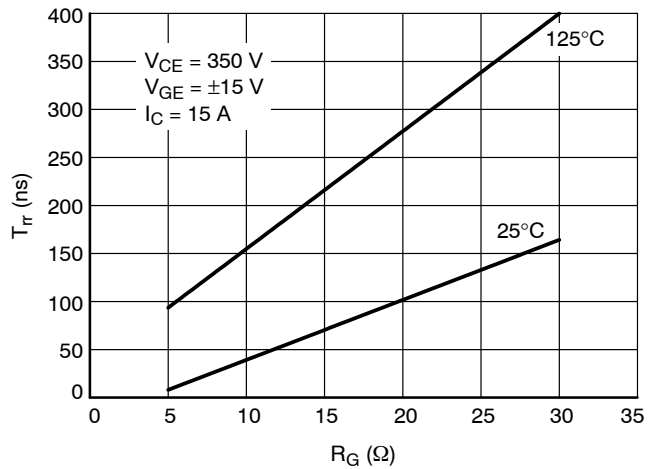

Figure 59. Typical Reverse Recovery Time vs.  $R_G$

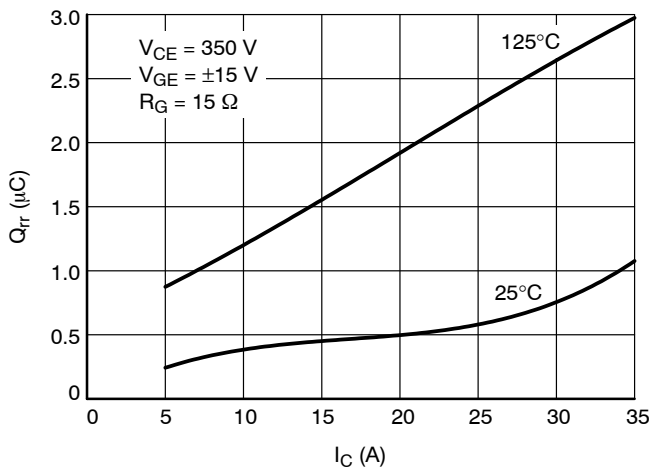

Figure 60. Typical Reverse Recovery Charge vs.  $I_C$

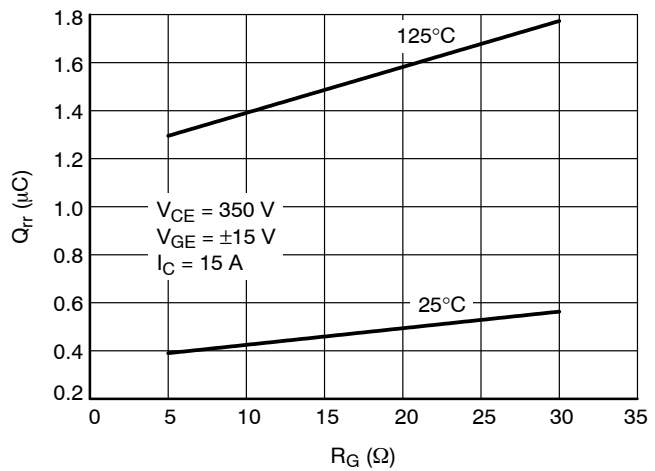

Figure 61. Typical Reverse Recovery Charge vs.  $R_G$

# NXH25T120L2Q1PG

## TYPICAL CHARACTERISTICS – NEUTRAL POINT IGBT COMUTATES HALF BRIDGE DIODE

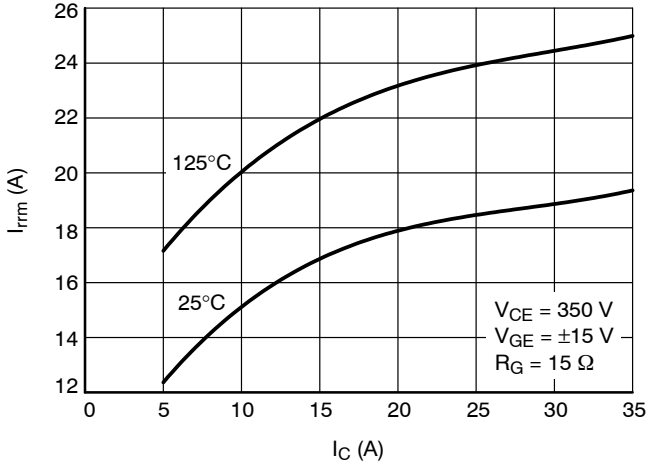

Figure 62. Typical Reverse Recovery Current vs.  $I_C$

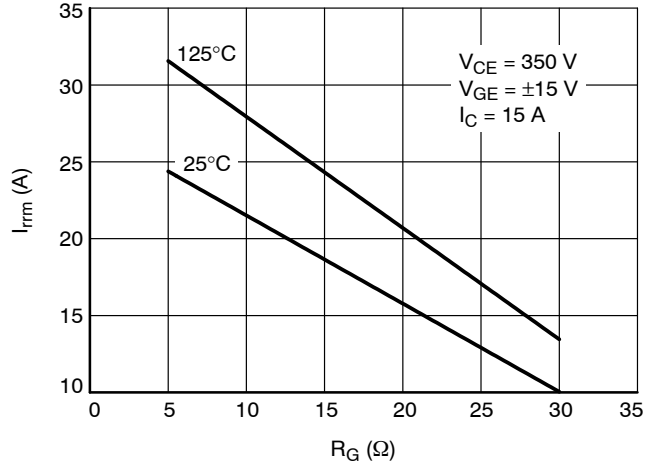

Figure 63. Typical Reverse Recovery Current vs.  $R_G$

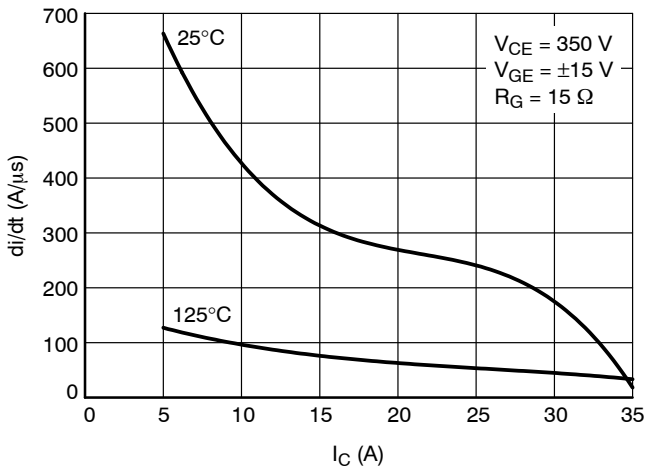

Figure 64. Typical  $di/dt$  vs.  $I_C$

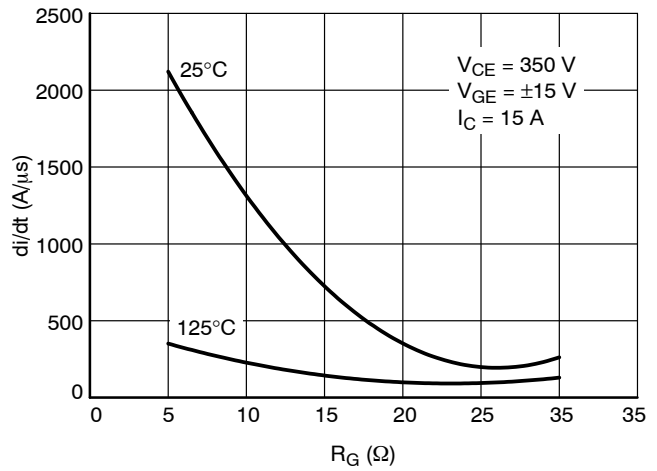

Figure 65. Typical  $di/dt$  vs.  $R_G$

# MECHANICAL CASE OUTLINE PACKAGE DIMENSIONS

ON Semiconductor®



PIM44, 71x37.4  
CASE 180AS  
ISSUE 0

DATE 25 JUN 2018

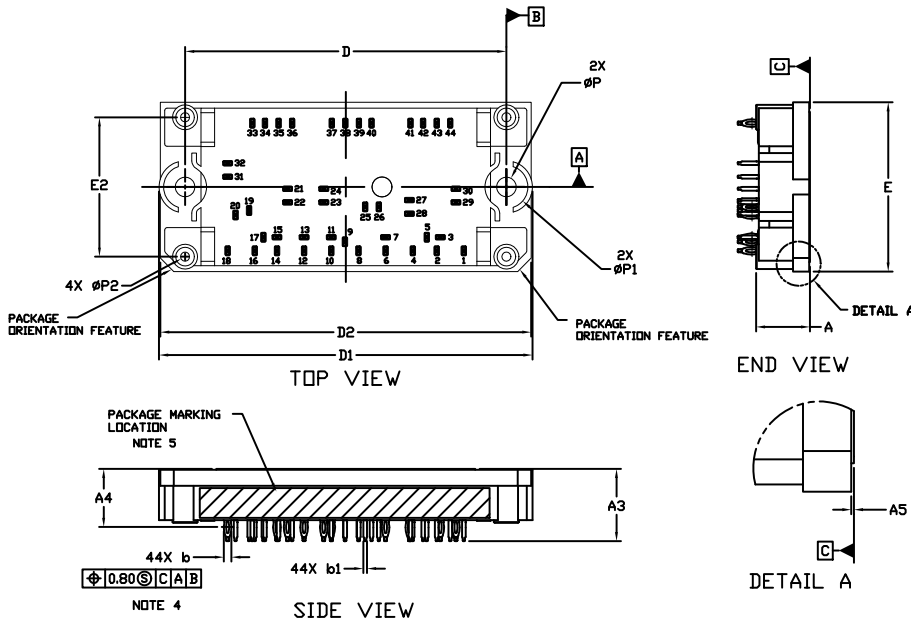

PIN	PIN POSITION		PIN	PIN POSITION	
	X	Y		X	Y
1	26.10	14.10	23	-4.85	3.40
2	20.10	14.10	24	-4.85	0.40
3	20.90	11.10	25	4.30	4.40
4	14.80	14.10	26	7.30	4.40
5	17.90	11.10	27	14.05	2.90
6	8.80	14.10	28	14.05	5.90
7	8.80	11.10	29	24.35	3.40
8	2.80	14.10	30	24.35	0.40
9	-0.20	12.10	31	-26.10	-2.25
10	-3.20	14.10	32	-26.10	-5.25
11	-3.20	11.10	33	-20.65	-14.10
12	-9.20	14.10	34	-17.85	-14.10
13	-9.20	11.10	35	-14.85	-14.10
14	-15.20	14.10	36	-11.85	-14.10
15	-15.20	11.10	37	-3.10	-14.10
16	-20.10	14.10	38	-0.10	-14.10
17	-18.20	11.10	39	2.90	-14.10
18	-26.10	14.10	40	5.70	-14.10
19	-21.35	5.20	41	14.30	-14.10
20	-24.35	6.20	42	17.10	-14.10
21	-12.85	0.40	43	20.10	-14.10
22	-12.85	3.40	44	23.10	-14.10

NOTE 4

PIN	PIN POSITION		PIN	PIN POSITION	
	X	Y		X	Y
1	26.10	-14.10	23	-4.85	-3.40
2	20.10	-14.10	24	-4.85	-0.40
3	20.90	-11.10	25	4.30	-4.40
4	14.80	-14.10	26	7.30	-4.40
5	17.90	-11.10	27	14.05	-2.90
6	8.80	-14.10	28	14.05	-5.90
7	8.80	-11.10	29	24.35	-3.40
8	2.80	-14.10	30	24.35	-0.40
9	-0.20	-12.10	31	-26.10	2.25
10	-3.20	-14.10	32	-26.10	5.25
11	-3.20	-11.10	33	-20.65	14.10
12	-9.20	-14.10	34	-17.85	14.10
13	-9.20	-11.10	35	-14.85	14.10
14	-15.20	-14.10	36	-11.85	14.10
15	-15.20	-11.10	37	-3.10	14.10
16	-20.10	-14.10	38	-0.10	14.10
17	-18.20	-11.10	39	2.90	14.10
18	-26.10	-14.10	40	5.70	14.10
19	-21.35	-5.20	41	14.30	14.10
20	-24.35	-6.20	42	17.10	14.10
21	-12.85	-0.40	43	20.10	14.10
22	-12.85	-3.40	44	23.10	14.10

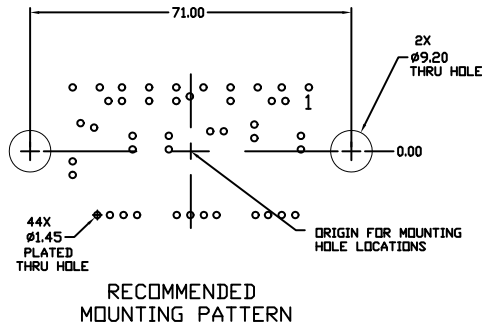

DIM	MILLIMETERS		
	MIN.	NDM.	MAX.
A	11.50	12.00	12.50
A3	15.50	16.00	16.50
A4	12.83 BSC		
A5	0.10	0.20	0.30
b	1.61	1.66	1.71
b1	0.75	0.80	0.85
D	70.50	71.00	71.50
D1	82.00	82.50	83.00
D2	81.50	82.00	82.50
E	36.90	37.40	37.90
E2	30.30	30.80	31.30
P	4.10	4.30	4.50
P1	9.30	9.50	9.70
P2	1.80	2.00	2.20

NOTES:

- DIMENSIONING AND TOLERANCING PER ASME Y14.5M, 2009.
- CONTROLLING DIMENSION: MILLIMETERS
- DIMENSIONS b AND b1 APPLY TO THE PLATED TERMINALS AND ARE MEASURED AT DIMENSION A4.
- POSITION OF THE CENTER OF THE TERMINALS IS DETERMINED FROM DATUM B THE CENTER OF DIMENSION D, X DIRECTION, AND FROM DATUM A, Y DIRECTION. POSITIONAL TOLERANCE, AS NOTED IN DRAWING, APPLIES TO EACH TERMINAL IN BOTH DIRECTIONS.
- PACKAGE MARKING IS LOCATED AS SHOWN ON THE SIDE OPPOSITE THE PACKAGE ORIENTATION FEATURES.

DOCUMENT NUMBER:	98AON92314G	Electronic versions are uncontrolled except when accessed directly from the Document Repository. Printed versions are uncontrolled except when stamped "CONTROLLED COPY" in red.
DESCRIPTION:	PIM44, 71x37.4	PAGE 1 OF 2

ON Semiconductor and are trademarks of Semiconductor Components Industries, LLC dba ON Semiconductor or its subsidiaries in the United States and/or other countries. ON Semiconductor reserves the right to make changes without further notice to any products herein. ON Semiconductor makes no warranty, representation or guarantee regarding the suitability of its products for any particular purpose, nor does ON Semiconductor assume any liability arising out of the application or use of any product or circuit, and specifically disclaims any and all liability, including without limitation special, consequential or incidental damages. ON Semiconductor does not convey any license under its patent rights nor the rights of others.

**PIM44, 71x37.4**  
**CASE 180AS**  
**ISSUE O**

DATE 15 JUN 2018

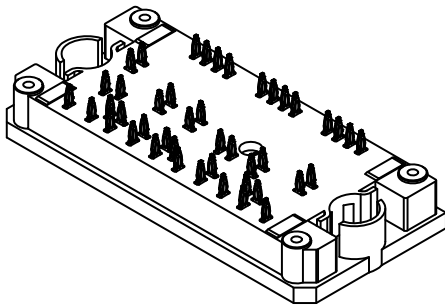

**GENERIC  
MARKING DIAGRAM\***

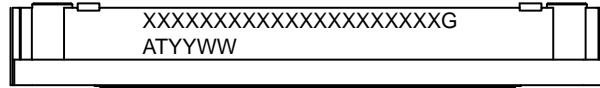

XXXXX = Specific Device Code  
G = Pb-Free Package  
AT = Assembly & Test Site Code  
YYWW = Year and Work Week Code

\*This information is generic. Please refer to device data sheet for actual part marking. Pb-Free indicator, "G" or microdot "•", may or may not be present. Some products may not follow the Generic Marking.

<b>DOCUMENT NUMBER:</b>	<b>98AON92314G</b>	Electronic versions are uncontrolled except when accessed directly from the Document Repository. Printed versions are uncontrolled except when stamped "CONTROLLED COPY" in red.
<b>DESCRIPTION:</b>	<b>PIM44, 71x37.4</b>	<b>PAGE 2 OF 2</b>

ON Semiconductor and  are trademarks of Semiconductor Components Industries, LLC dba ON Semiconductor or its subsidiaries in the United States and/or other countries. ON Semiconductor reserves the right to make changes without further notice to any products herein. ON Semiconductor makes no warranty, representation or guarantee regarding the suitability of its products for any particular purpose, nor does ON Semiconductor assume any liability arising out of the application or use of any product or circuit, and specifically disclaims any and all liability, including without limitation special, consequential or incidental damages. ON Semiconductor does not convey any license under its patent rights nor the rights of others.

[www.onsemi.com](http://www.onsemi.com)

**onsemi**, **Onsemi**, and other names, marks, and brands are registered and/or common law trademarks of Semiconductor Components Industries, LLC dba "**onsemi**" or its affiliates and/or subsidiaries in the United States and/or other countries. **onsemi** owns the rights to a number of patents, trademarks, copyrights, trade secrets, and other intellectual property. A listing of **onsemi**'s product/patent coverage may be accessed at [www.onsemi.com/site/pdf/Patent-Marking.pdf](http://www.onsemi.com/site/pdf/Patent-Marking.pdf). **onsemi** reserves the right to make changes at any time to any products or information herein, without notice. The information herein is provided "as-is" and **onsemi** makes no warranty, representation or guarantee regarding the accuracy of the information, product features, availability, functionality, or suitability of its products for any particular purpose, nor does **onsemi** assume any liability arising out of the application or use of any product or circuit, and specifically disclaims any and all liability, including without limitation special, consequential or incidental damages. Buyer is responsible for its products and applications using **onsemi** products, including compliance with all laws, regulations and safety requirements or standards, regardless of any support or applications information provided by **onsemi**. "Typical" parameters which may be provided in **onsemi** data sheets and/or specifications can and do vary in different applications and actual performance may vary over time. All operating parameters, including "Typicals" must be validated for each customer application by customer's technical experts. **onsemi** does not convey any license under any of its intellectual property rights nor the rights of others. **onsemi** products are not designed, intended, or authorized for use as a critical component in life support systems or any FDA Class 3 medical devices or medical devices with a same or similar classification in a foreign jurisdiction or any devices intended for implantation in the human body. Should Buyer purchase or use **onsemi** products for any such unintended or unauthorized application, Buyer shall indemnify and hold **onsemi** and its officers, employees, subsidiaries, affiliates, and distributors harmless against all claims, costs, damages, and expenses, and reasonable attorney fees arising out of, directly or indirectly, any claim of personal injury or death associated with such unintended or unauthorized use, even if such claim alleges that **onsemi** was negligent regarding the design or manufacture of the part. **onsemi** is an Equal Opportunity/Affirmative Action Employer. This literature is subject to all applicable copyright laws and is not for resale in any manner.

## ADDITIONAL INFORMATION

### TECHNICAL PUBLICATIONS:

Technical Library: [www.onsemi.com/design/resources/technical-documentation](http://www.onsemi.com/design/resources/technical-documentation)  
onsemi Website: [www.onsemi.com](http://www.onsemi.com)

### ONLINE SUPPORT: [www.onsemi.com/support](http://www.onsemi.com/support)

For additional information, please contact your local Sales Representative at [www.onsemi.com/support/sales](http://www.onsemi.com/support/sales)