

EL5625

Programmable 18-Channel Gamma with 1-Channel VCOM with Reference

FN7488  
Rev 1.00  
February 20, 2008

The EL5625 represents a high integration programmable buffer solution from Intersil. The device integrates 18-channels of programmable buffers, with a single programmable  $V_{COM}$ , a reference output, and a supply side LDO.

The 18-channel programmable buffers have 11-bit resolution and rail-to-rail outputs. Each output is capable of driving 15mA continuous.

The  $V_{COM}$  output also features 11-bits of resolution. The generated voltage is connected to the non-inverting input of the integrated  $V_{COM}$  amplifier. This amplifier has a short-circuit current of 1A, 100mA continuous.

The integrated low drop-out regulator is used, in conjunction with an external transistor, to provide a solid supply voltage to the device. It features 200mV minimum drop-out and has very good load regulation for the cleanest gamma and  $V_{COM}$  outputs.

The EL5625 also includes over-temperature protection and is available in a 38 Ld QFN package.

Pinout

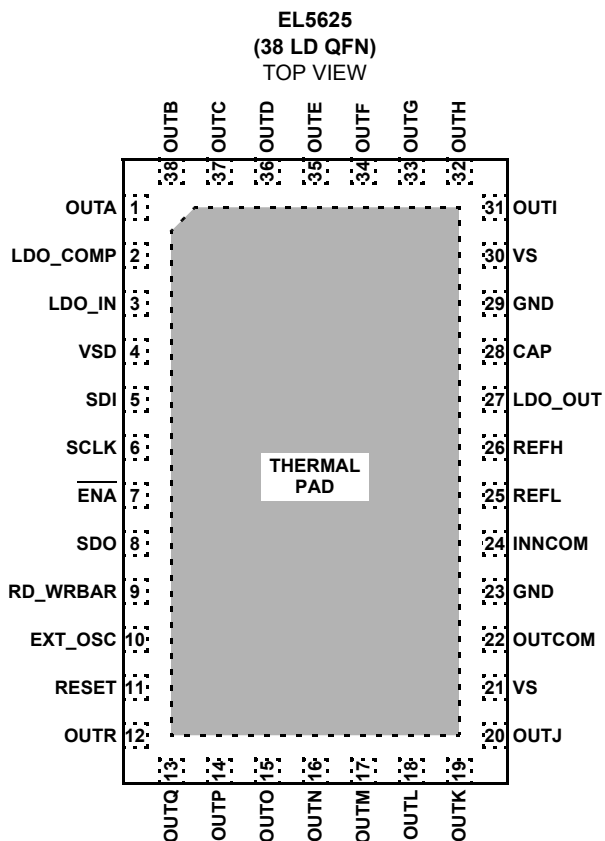

Features

- 18-channel programmable gamma
  - Rail-to-rail
- Single  $V_{COM}$  amplifier
  - 1A peak output
- 11-bit resolution per output
- Accuracy  $\pm 0.5\%$
- Integrated supply LDO
  - Low drop out - 200mV
- Integrated reference
  - Very accurate - 0.75%
- +7V to +16V supply
- Thermal protection
- 38 Ld QFN
- Pb-free (RoHS compliant)

Applications

- LCD-TVs
- Flat panel monitors
- TFT-LCD displays

Ordering Information

| PART NUMBER<br>(See Note) | PART MARKING | PACKAGE<br>(Pb-Free)         | PKG. DWG. # |
|---------------------------|--------------|------------------------------|-------------|
| EL5625ILZ                 | 5625ILZ      | 38 Ld QFN                    | MDP0046     |
| EL5625ILZ-T13             | 5625ILZ      | 38 Ld QFN<br>(Tape and Reel) | MDP0046     |

\*Please refer to TB347 for details on reel specifications.

NOTE: These Intersil Pb-free plastic packaged products employ special Pb-free material sets; molding compounds/die attach materials and 100% matte tin plate PLUS ANNEAL - e3 termination finish, which is RoHS compliant and compatible with both SnPb and Pb-free soldering operations. Intersil Pb-free products are MSL classified at Pb-free peak reflow temperatures that meet or exceed the Pb-free requirements of IPC/JEDEC J STD-020.

**Absolute Maximum Ratings** ( $T_A = +25^\circ\text{C}$ )

Supply Voltage between  $V_S$  and GND . . . . . 4.5V(min) to 18V(max)  
 Supply Voltage between  $V_{SD}$  and GND 3V(min) to  $V_S$  and +7(max)  
 Maximum Continuous Output Current (Gamma) . . . . . 15mA  
 Maximum Continuous Output Current ( $V_{COM}$ ) . . . . . 100mA

Ambient Operating Temperature . . . . .  $-40^\circ\text{C}$  to  $+85^\circ\text{C}$   
 Maximum Die Temperature . . . . .  $+125^\circ\text{C}$   
 Storage Temperature . . . . .  $-65^\circ\text{C}$  to  $+150^\circ\text{C}$   
 Pb-Free Reflow Profile. . . . . see link below  
<http://www.intersil.com/pbfree/Pb-FreeReflow.asp>

**CAUTION:** Do not operate at or near the maximum ratings listed for extended periods of time. Exposure to such conditions may adversely impact product reliability and result in failures not covered by warranty.

**IMPORTANT NOTE:** All parameters having Min/Max specifications are guaranteed. Typical values are for information purposes only. Unless otherwise noted, all tests are at the specified temperature and are pulsed tests, therefore:  $T_J = T_C = T_A$

**Electrical Specifications**  $V_S = 15\text{V}$ ,  $V_{SD} = 5\text{V}$ ,  $V_{REFH} = 13\text{V}$ ,  $V_{REFL} = 2\text{V}$ ,  $R_L = 1.5\text{k}\Omega$  and  $C_L = 200\text{pF}$  to  $0\text{V}$ ,  $T_A = +25^\circ\text{C}$ , unless otherwise specified.

| PARAMETER        | DESCRIPTION                                | CONDITIONS  | MIN   | TYP   | MAX   | UNIT             |
|------------------|--|---|-------|-------|-------|------------------|
| <b>SUPPLY</b>    |  |   |       |       |       |                  |
| $I_S$            | Supply Current                             | No load   |       | 11    | 15    | mA               |
| $I_{SD}$         | Digital Supply Current                     |   |       | 1.1   | 1.35  | mA               |
| <b>ANALOG</b>    |  |   |       |       |       |                  |
| $V_{OL}$         | Output Swing Low (Chan 1-16)               | Sinking 5mA ( $V_{REFH} = 15\text{V}$ , $V_{REFL} = 0$ )  |       | 100   | 200   | mV               |
|                  | Output Swing Low (Chan 17, 18)             |   |       | 50    | 150   | mV               |
| $V_{OH}$         | Output Swing High (Chan 1, 2)              | Sourcing 5mA ( $V_{REFH} = 15\text{V}$ , $V_{REFL} = 0$ ) | 14.85 | 14.95 |       | V                |
|                  | Output Swing High (Chan 3-18)              |   | 14.8  | 14.9  |       | V                |
| $I_{SC}$         | Short Circuit Current                      | $R_L = 10\Omega$  | 100   | 130   |       | mA               |
| PSRR             | Power Supply Rejection Ratio               | $V_{S+}$ is moved from 14V to 16V                         | 50    | 70    |       | dB               |
|                  |  | $V_{COM}$   | 45    | 60    |       | dB               |
| $t_D$            | Program to Out Delay                       |   |       | 4     |       | ms               |
| $V_{AC}$         | Accuracy Referred to the Ideal Value       | Code = 512  |       | 20    |       | mV               |
| $\Delta V_{MIS}$ | Channel to Channel Mismatch                | Code = 512  |       | 2     |       | mV               |
| $V_{DROOP}$      | Droop Voltage                              |   |       | 1     | 2     | mV/ms            |
| $R_{INH}$        | Input Resistance @ $V_{REFH}$ , $V_{REFL}$ |   | 25    | 32    |       | $\text{k}\Omega$ |
| REG              | Load Regulation                            | $I_{OUT} = 5\text{mA}$ step                               |       | 1     | 3     | mV/mA            |
| BG               | Band Gap                                   |   | 1.227 | 1.242 | 1.257 | V                |
| <b>DIGITAL</b>   |  |   |       |       |       |                  |
| $V_{IH}$         | Logic 1 Input Voltage                      |   | 2     |       |       | V                |
| $V_{IL}$         | Logic 0 Input Voltage                      |   |       |       | 1     | V                |
| $F_{CLK}$        | Clock Frequency                            |   |       | 5     |       | MHz              |
| $t_S$            | Setup Time                                 |   |       | 20    |       | ns               |
| $t_H$            | Hold Time                                  |   |       | 20    |       | ns               |
| $t_{LC}$         | Load to Clock Time                         |   |       | 20    |       | ns               |
| $t_{CE}$         | Clock to Load Line                         |   |       | 20    |       | ns               |
| $t_{DCO}$        | Clock to Out Delay Time                    | Negative edge of SCLK                                     |       | 10    |       | ns               |
| $R_{SDIN}$       | $S_{DIN}$ Input Resistance                 |   |       | 1     |       | $\text{G}\Omega$ |
| $T_{PULSE}$      | Minimum Pulse Width for EXT_OSC Signal     |   |       | 5     |       | $\mu\text{s}$    |

**Electrical Specifications**  $V_S = 15V$ ,  $V_{SD} = 5V$ ,  $V_{REFH} = 13V$ ,  $V_{REFL} = 2V$ ,  $R_L = 1.5k\Omega$  and  $C_L = 200pF$  to  $0V$ ,  $T_A = +25^\circ C$ , unless otherwise specified. **(Continued)**

| PARAMETER                              | DESCRIPTION                           | CONDITIONS     | MIN | TYP  | MAX | UNIT       |
|--|---------------------------------------|----------------|-----|------|-----|------------|
| Duty Cycle                             | Duty Cycle for EXT_OSC Signal         |                |     | 50   |     | %          |
| F_OSC                                  | Internal Refresh Oscillator Frequency | OSC_Select = 0 |     | 21   |     | kHz        |
| INL                                    | Integral Nonlinearity Error           |                |     | 1.3  |     | LSB        |
| DNL                                    | Differential Nonlinearity Error       |                |     | 0.5  |     | LSB        |
| <b>V<sub>COM</sub> CHARACTERISTICS</b> |                                       |                |     |      |     |            |
| BW                                     | Bandwidth of V <sub>COM</sub>         |                |     | 10   |     | MHz        |
| SR                                     | Slew Rate                             |                | 5   | 9    |     | V/ $\mu$ s |
| I <sub>SC</sub>                        | Short-Circuit Current                 |                |     | 1000 |     | mA         |

**Typical Application Diagram**

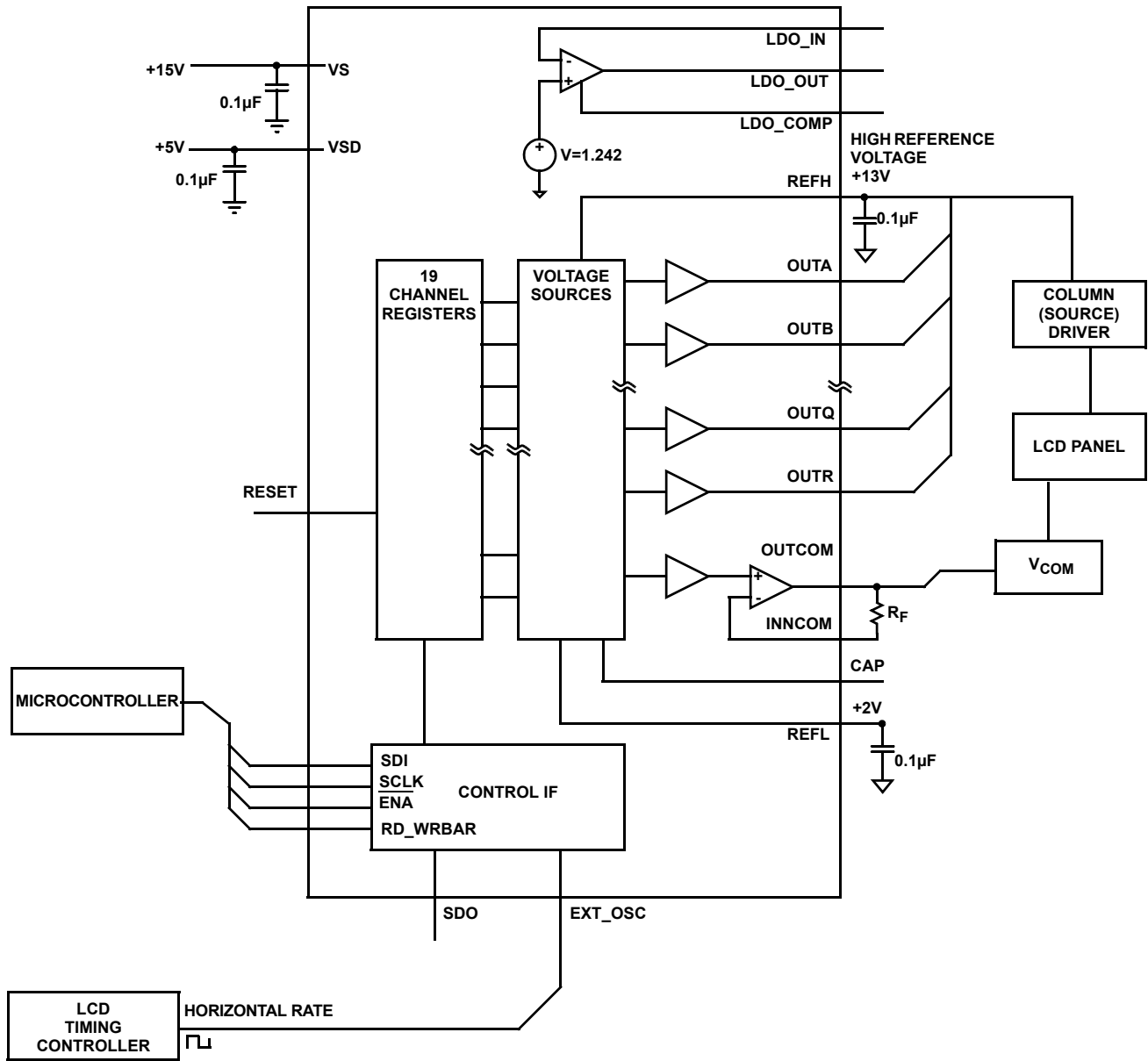

## Pin Descriptions

| PIN NUMBER | PIN NAME                | PIN TYPE      | PIN DESCRIPTION  |
|------------|-------------------------|---------------|--|
| 1          | OUTA                    | Analog Output | Channel A output voltage                                   |
| 2          | LDO_COMP                | Analog Input  | LDO compensation capacitor                                 |
| 3          | LDO_IN                  | Analog Input  | LDO inverting input  |
| 4          | VSD                     | Power         | Positive power supply for digital circuits (3.3V - 5V)     |
| 5          | SDI                     | Logic Input   | Serial data input  |
| 6          | SCLK                    | Logic Input   | Serial data clock  |
| 7          | $\overline{\text{ENA}}$ | Logic Input   | Chip select, low enables data input to logic               |
| 8          | SDO                     | Logic Output  | Serial data output   |
| 9          | RD_WRBAR                | Analog Input  | Read, write select: "0" = write, "1" = read                |
| 10         | EXT_OSC                 | Input/Output  | Oscillator pin for synchronizing                           |
| 11         | RESET                   | Analog Input  | Reset all registers: "0" = reset                           |
| 12         | OUTR                    | Analog Output | Channel R output voltage                                   |
| 13         | OUTQ                    | Analog Output | Channel Q output voltage                                   |
| 14         | OUTP                    | Analog Output | Channel P output voltage                                   |
| 15         | OUTO                    | Analog Output | Channel O output voltage                                   |
| 16         | OUTN                    | Analog Output | Channel N output voltage                                   |
| 17         | OUTM                    | Analog Output | Channel M output voltage                                   |
| 18         | OUTL                    | Analog Output | Channel L output voltage                                   |
| 19         | OUTK                    | Analog Output | Channel K output voltage                                   |
| 20         | OUTJ                    | Analog Output | Channel J output voltage                                   |
| 21, 30     | VS                      | Power         | Positive supply voltage for analog circuits (4.5V - 16.5V) |
| 22         | OUTCOM                  | Analog Output | V <sub>COM</sub> output                                    |
| 23, 29     | GND                     | Power         | Ground   |
| 24         | INNCOM                  | Analog Input  | V <sub>COM</sub> inverting input                           |
| 25         | REFL                    | Analog Input  | Low reference voltage                                      |
| 26         | REFH                    | Analog Input  | High reference voltage                                     |
| 27         | LDO_OUT                 | Analog Output | LDO output   |
| 28         | CAP                     | Analog        | Decoupling capacitor for internal reference                |
| 31         | OUTI                    | Analog Output | Channel I output voltage                                   |
| 32         | OUTH                    | Analog Output | Channel H output voltage                                   |
| 33         | OUTG                    | Analog Output | Channel G output voltage                                   |
| 34         | OUTF                    | Analog Output | Channel F output voltage                                   |
| 35         | OUTE                    | Analog Output | Channel E output voltage                                   |
| 36         | OUTD                    | Analog Output | Channel D output voltage                                   |
| 37         | OUTC                    | Analog Output | Channel C output voltage                                   |
| 38         | OUTB                    | Analog Output | Channel B output voltage                                   |

Typical Performance Curves

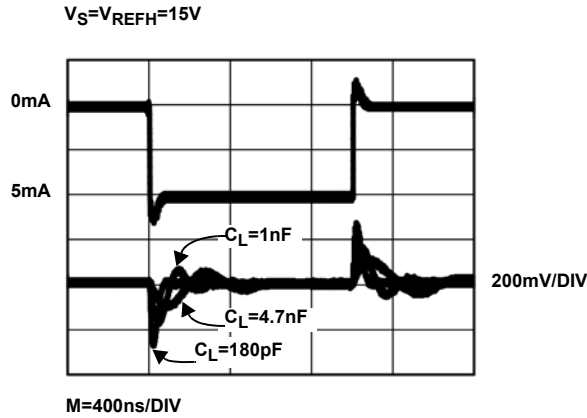

FIGURE 1. TRANSIENT LOAD REGULATION (SOURCING)

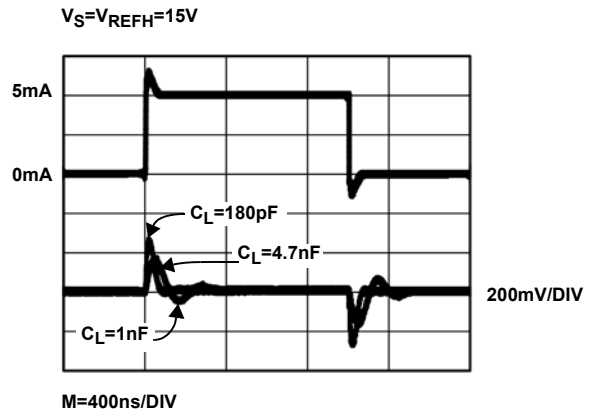

FIGURE 2. TRANSIENT LOAD REGULATION (SINKING)

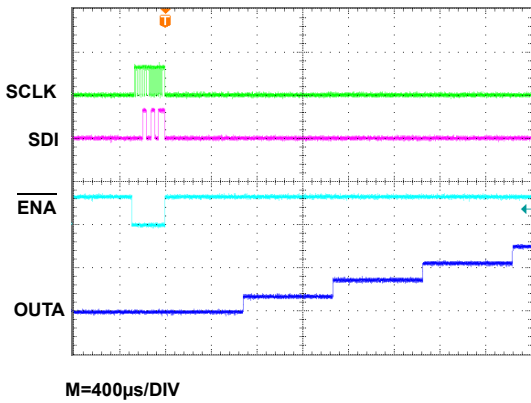

FIGURE 3. LARGE SIGNAL RESPONSE (RISING FROM 0V TO 8V)

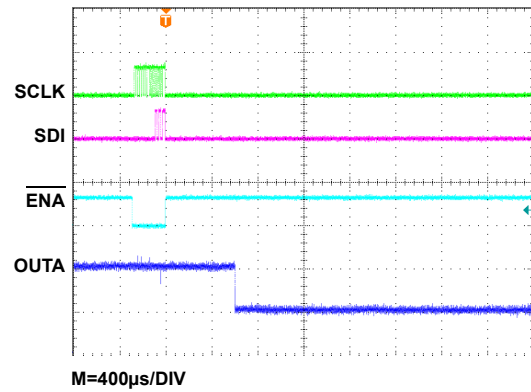

FIGURE 4. SMALL SIGNAL RESPONSE (FALLING FROM 200mV TO 100mV)

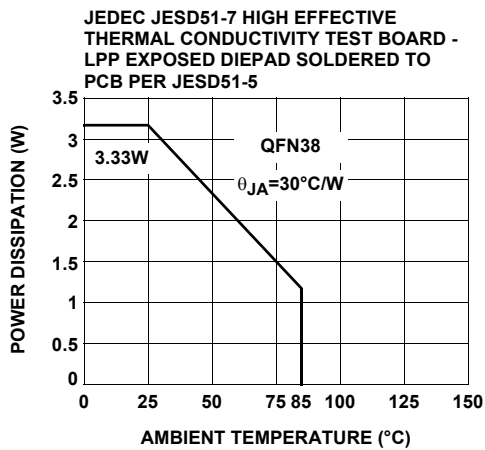

FIGURE 5. PACKAGE POWER DISSIPATION vs AMBIENT TEMPERATURE

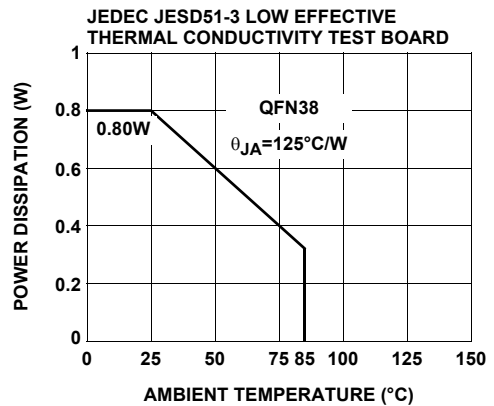

FIGURE 6. PACKAGE POWER DISSIPATION vs AMBIENT TEMPERATURE

## General Description

The EL5625 is designed to produce the reference voltages required in TFT-LCD applications. Each output is programmed to the required voltage with 11 bits of resolution. Ref-High and Ref-Low pins determine the high and low voltages of the output range. These outputs can be driven to within 50mV of the power rails of the EL5625. Programming of each output, 18 buffers and 1 Vcom, is performed using the USB interface.

### USB Interface

The EL5625 uses USB interface to control the 18 Gamma channels and Vcom channel (Figure 7). Software is available for download on Intersil's website.

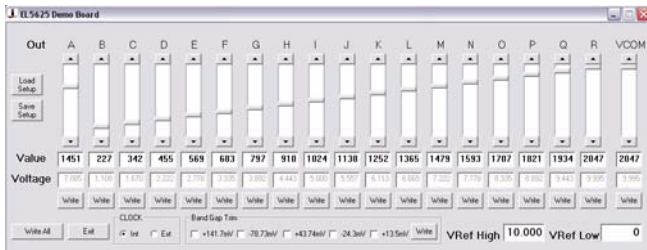

FIGURE 7. USB INTERFACE

### Serial Interface

The EL5625 is programmed through a three-wire serial interface. The start and stop conditions are defined by the ENA signal. While the ENA is low, the data on the SDI (serial data input) pin is shifted into the 16-bit shift register on the positive edge of the SCLK (serial clock) signal. The MSB (bit 15) is loaded first and the LSB (bit 0) is loaded last (see Table 1). After the full 16-bit data has been loaded, the ENA is pulled high and the addressed output channel is updated. The SCLK is disabled internally when the ENA is high. The SCLK must be low before the ENA is pulled low.

The Serial Timing Diagram and parameters table show the timing requirements for three-wire signals.

The serial data has a minimum length of 16 bits, the MSB (most significant bit) is the first bit in the signal. The bits are allocated to the following functions (also refer to the Control Bits Logic Table).

- Bits 15 through 11 select the channel to be written to, these are binary coded with channel A = 0, and channel R = 17
- The 11-bit data is on bits 10 through 0. Some examples of data words are shown in the table of Serial Programming Examples

TABLE 1. CONTROL BITS LOGIC TABLE

| BIT | NAME | DESCRIPTION     |
|-----|------|-----------------|
| B15 | A4   | Channel Address |
| B14 | A3   | Channel Address |
| B13 | A2   | Channel Address |
| B12 | A1   | Channel Address |
| B11 | A0   | Channel Address |
| B10 | D10  | Data            |
| B9  | D9   | Data            |
| B8  | D8   | Data            |
| B7  | D7   | Data            |
| B6  | D6   | Data            |
| B5  | D5   | Data            |
| B4  | D4   | Data            |
| B3  | D3   | Data            |
| B2  | D2   | Data            |
| B1  | D1   | Data            |
| B0  | D0   | Data            |

## Serial Timing Diagram

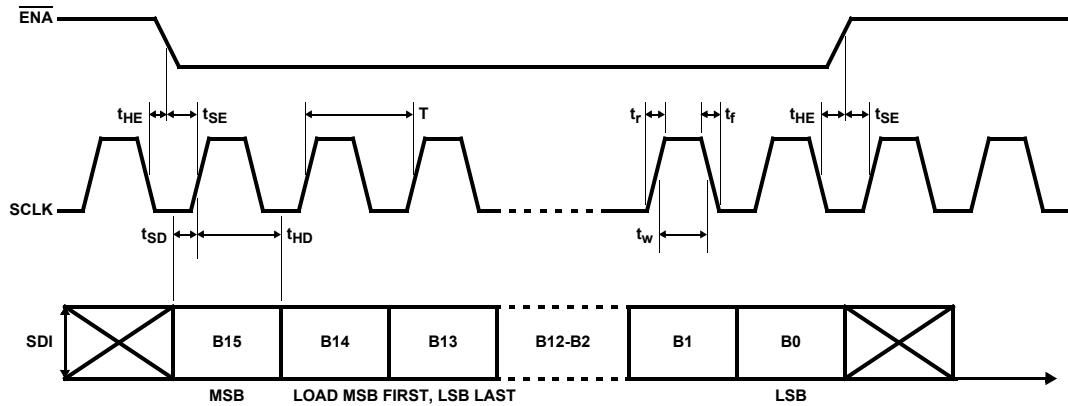

TABLE 2. SERIAL TIMING PARAMETERS

| PARAMETER | RECOMMENDED OPERATING RANGE | DESCRIPTION             |
|-----------|-----------------------------|-------------------------|
| T         | ≥200ns                      | Clock Period            |
| tr/tf     | 0.05 * T                    | Clock Rise/Fall Time    |
| tHE       | ≥10ns                       | EN $\bar{A}$ Hold Time  |
| tSE       | ≥10ns                       | EN $\bar{A}$ Setup Time |
| tHD       | ≥10ns                       | Data Hold Time          |
| tSD       | ≥10ns                       | Data Setup Time         |
| tw        | 0.50 * T                    | Clock Pulse Width       |

### V<sub>COM</sub> Amplifier

The V<sub>COM</sub> amplifier is designed to control the voltage on the back plate of an LCD display. This plate is capacitively coupled to the pixel drive voltage which alternately cycles positive and negative at the line rates for the display. Thus the amplifier must be capable of sourcing and sinking capacitive pulse of current, which can be quite large (100mA for typical applications).

### Analog Section

#### TRANSFER FUNCTION

The transfer function is:

$$V_{OUT(IDEAL)} = V_{REFL} + \frac{data}{2048} \times (V_{REFH} - V_{REFL})$$

where data is the decimal value of the 11-bit data binary input code.

The output voltages from the EL5625 will be derived from the reference voltages present at the V<sub>REFL</sub> and V<sub>REFH</sub> pins. The impedance between those two pins is about 32kΩ.

Care should be taken that the system design holds these two reference voltages within the limits of the power rails of the EL5625.  $GND < V_{REFH} \leq V_S$  and  $GND \leq V_{REFL} \leq V_{REFH}$ .

### CLOCK OSCILLATOR

The EL5625 requires an internal clock or external clock to refresh its outputs. The outputs are refreshed at the falling OSC clock edges. The output refreshed switches open at the rising edges of the OSC clock. The driving load shouldn't be changed at the rising edges of the OSC clock. Otherwise, it will generate a voltage error at the outputs. This clock may be input or output via the clock pin labelled EXT\_OSC. The internal clock is provided by an internal oscillator running at approximately 21kHz and can be output to the EXT\_OSC pin. In a 2 chip system, if the driving loads are stable, one chip may be programmed to use the internal oscillator; then the OSC pin will output the clock from the internal oscillator. The second chip may have the OSC pin connected to this clock source.

For transient load application, the external clock mode should be used to ensure all functions are synchronized together. The positive edge of the external clock to the OSC pin should be timed to avoid the transient load effect. The Application Drawing shows the LCD H rate signal used, here the positive clock edge is timed to avoid the transient load of the column driver circuits.



TABLE 3. OSC CONTROL LOGIC TABLE WITH BAND GAP TRIM SELECTION

| Name         | Band Gap Trim (mV) |    |    |    |    |    |     |    |    | INT/EXT |    |    |    |    |    |    |    |
|--------------|--------------------|----|----|----|----|----|-----|----|----|---------|----|----|----|----|----|----|----|
|              |                    | A4 | A3 | A2 | A1 | A0 | D10 | D9 | D8 | D7      | D6 | D5 | D4 | D3 | D2 | D1 | D0 |
| BIT          |                    | 15 | 14 | 13 | 12 | 11 | 10  | 9  | 8  | 7       | 6  | 5  | 4  | 3  | 2  | 1  | 0  |
| Internal OSC | 13.5               | 1  | 0  | 0  | 1  | 1  | 0   | 0  | 0  | 0       | 0  | 0  | 0  | 0  | 0  | 0  | 1  |
|              | -24.3              | 1  | 0  | 0  | 1  | 1  | 0   | 0  | 0  | 0       | 0  | 0  | 0  | 0  | 0  | 1  | 0  |
|              | 43.74              | 1  | 0  | 0  | 1  | 1  | 0   | 0  | 0  | 0       | 0  | 0  | 0  | 0  | 1  | 0  | 0  |
|              | -78.73             | 1  | 0  | 0  | 1  | 1  | 0   | 0  | 0  | 0       | 0  | 0  | 0  | 1  | 0  | 0  | 0  |
|              | 141.7              | 1  | 0  | 0  | 1  | 1  | 0   | 0  | 0  | 0       | 0  | 0  | 1  | 0  | 0  | 0  | 0  |
| External OSC | 13.5               | 1  | 0  | 0  | 1  | 1  | 0   | 0  | 0  | 1       | 0  | 0  | 0  | 0  | 0  | 0  | 1  |
|              | -24.3              | 1  | 0  | 0  | 1  | 1  | 0   | 0  | 0  | 1       | 0  | 0  | 0  | 0  | 0  | 1  | 0  |
|              | 43.74              | 1  | 0  | 0  | 1  | 1  | 0   | 0  | 0  | 1       | 0  | 0  | 0  | 0  | 1  | 0  | 0  |
|              | -78.73             | 1  | 0  | 0  | 1  | 1  | 0   | 0  | 0  | 1       | 0  | 0  | 0  | 1  | 0  | 0  | 0  |
|              | 141.7              | 1  | 0  | 0  | 1  | 1  | 0   | 0  | 0  | 1       | 0  | 0  | 1  | 0  | 0  | 0  | 0  |

TABLE 4. CHANNEL ADDRESS OF OUTPUT CHANNEL

| OUT CHANNEL                | REGISTER ADDRESS | CHANNEL ADDRESS |   |   |   |   |   |   |   |  |
|----------------------------|------------------|-----------------|---|---|---|---|---|---|---|--|
| A                          | 0                | 0               | 0 | 0 | 0 | 0 | 0 | 0 | 0 |  |
| B                          | 1                | 0               | 0 | 0 | 0 | 1 | 0 | 0 | 0 |  |
| C                          | 2                | 0               | 0 | 0 | 1 | 0 | 0 | 0 | 0 |  |
| D                          | 3                | 0               | 0 | 0 | 1 | 1 | 0 | 0 | 0 |  |
| E                          | 4                | 0               | 0 | 1 | 0 | 0 | 0 | 0 | 0 |  |
| F                          | 5                | 0               | 0 | 1 | 0 | 1 | 0 | 0 | 0 |  |
| G                          | 6                | 0               | 0 | 1 | 1 | 0 | 0 | 0 | 0 |  |
| H                          | 7                | 0               | 0 | 1 | 1 | 1 | 0 | 0 | 0 |  |
| I                          | 8                | 0               | 1 | 0 | 0 | 0 | 0 | 0 | 0 |  |
| J                          | 9                | 0               | 1 | 0 | 0 | 1 | 0 | 0 | 0 |  |
| K                          | 10               | 0               | 1 | 0 | 1 | 0 | 0 | 0 | 0 |  |
| L                          | 11               | 0               | 1 | 0 | 1 | 1 | 0 | 0 | 0 |  |
| M                          | 12               | 0               | 1 | 1 | 0 | 0 | 0 | 0 | 0 |  |
| N                          | 13               | 0               | 1 | 1 | 0 | 1 | 0 | 0 | 0 |  |
| O                          | 14               | 0               | 1 | 1 | 1 | 0 | 0 | 0 | 0 |  |
| P                          | 15               | 0               | 1 | 1 | 1 | 1 | 0 | 0 | 0 |  |
| Q                          | 16               | 0               | 0 | 0 | 0 | 0 | 0 | 0 | 0 |  |
| R                          | 17               | 0               | 0 | 0 | 0 | 0 | 1 | 0 | 0 |  |
| VCOM                       | 18               | 1               | 0 | 0 | 1 | 0 | 0 | 0 | 0 |  |
| INT/EXT &<br>BAND GAP TRIM | 19               | 1               | 0 | 0 | 1 | 1 | 0 | 0 | 0 |  |

**CHANNEL OUTPUTS**

Each of the channel outputs has a rail-to-rail buffer. This enables all channels to have the capability to drive to within 50mV of the power rails, (see Electrical Characteristics for details).

When driving large capacitive loads, a series resistor should be placed in series with the output (Usually between 5Ω and 50Ω).

Each of the channels is updated on a continuous cycle, the time for the new data to appear at a specific output will depend on the exact timing relationship of the incoming data to this cycle.

The best-case scenario is when the data has just been captured and then passed on to the output stage immediately; this can be as short as 48μs. In the worst-case scenario, this will be 860μs for EL5625, when the data has just missed the cycle at  $f_{OSC} = 21\text{kHz}$ .

When a large change in output voltage is required, the change will occur in 2V steps, thus the requisite number of timing cycles will be added to the overall update time. This means that a large change of 16V can take between 6.8ms and 7.2ms depending on the absolute timing relative to the update cycle.

**Output Stage and the Use of External Oscillator**

Simplified output sample and hold amp stage for one channel.

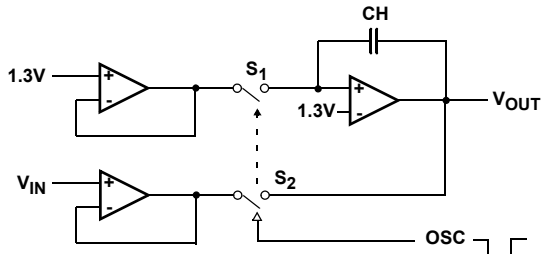

FIGURE 8.

The output voltage is generated from the DAC, which is  $V_{IN}$  in the above circuit. The refreshed switches are controlled by the internal or external oscillator signal. When the OSC clock signal is low, switches  $S_1$  and  $S_2$  are closed. The output  $V_{OUT} = V_{IN}$  and at the same time the sample and hold cap CH is being charged. When the OSC clock signal is high, the refreshed switches  $S_1$  and  $S_2$  are opened and the output voltage is maintained by CH. This refreshed process will repeat every 18 clock cycles for each channel. The time takes to update the output depends on the timing at the  $V_{IN}$  and the state of the switches. It can take 1 to 19 clock cycles to update each output.

For the sample and hold capacitor CH to maintain the correct output voltage, the driving load shouldn't be changed at the rising edge of the OSC signal. Since at the rising edge of the OSC clock, the refreshed switches are being opened, if the

load changes at that time, it will generate an error output voltage. For a fixed load condition, the internal oscillator can be used.

For the transient load condition, the external OSC mode should be used to avoid the conflict between the rising edge of the OSC signal and the changing load. So a timing delay circuit will be needed to delay the OSC signal and avoid the rising edge of the OSC signal and changing the load at the same time.

**TRANSIENT LOAD RESPONSE**

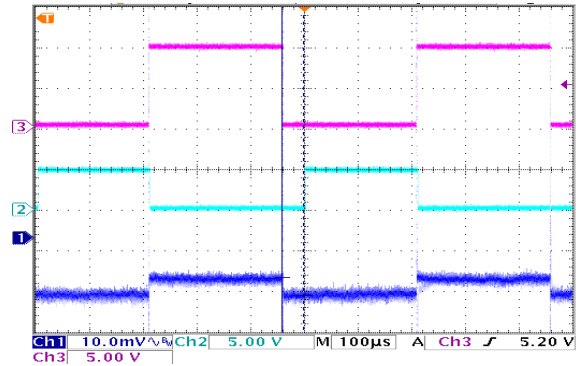

FIGURE 9.

Channel 3 --- sinking and sourcing 5mA current

Channel 2 --- EXT\_OSC signal

Channel 1 ---  $V_{OUT}$

Here, the OSC signal is synchronized to the load signal. The rising edge of the OSC signal is then delayed by some amount of time and gives enough time for CH to be charged to a new voltage before the switches are opened.

**CHANNEL TO CHANNEL REFRESH**

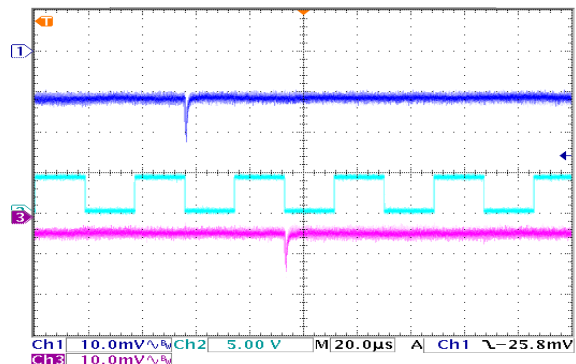

FIGURE 10.

Ch1 --- Output1

Ch3 --- Output2

Ch2 --- EXT\_OSC

At the falling edge of the OSC, output 1 is being refreshed and one clock cycle later, output 2 is being refreshed. The spike

you see here is the response of the output amplifier when the refreshed switches are closed. When driving a big capacitor load, there will be ringing at the spikes because the phase margin of the amplifier is decreased.

The speed of the external OSC signal shouldn't be greater than 70kHz because for the worst condition, it will take at least 4μs to charge the sample and hold capacitor CH. The pulse width has to be at least 4μs long. From our lab test, the duty cycle of the OSC signal must be greater than 30%.

### POWER DISSIPATION

With the 100mA maximum continuous output drive capability for V<sub>COM</sub> channel, it is possible to exceed the 125°C absolute maximum junction temperature. Therefore, it is important to calculate the maximum junction temperature for the application to determine if load conditions need to be modified for the part to remain in the safe operation.

The maximum power dissipation allowed in a package is determined according to:

$$P_{DMAX} = \frac{T_{JMAX} - T_{AMAX}}{\Theta_{JA}}$$

where:

- T<sub>JMAX</sub> = Maximum junction temperature
- T<sub>AMAX</sub> = Maximum ambient temperature
- θ<sub>JA</sub> = Thermal resistance of the package
- P<sub>DMAX</sub> = Maximum power dissipation in the package

The maximum power dissipation actually produced by the IC is the total quiescent supply current times the total power supply voltage and plus the power in the IC due to the loads.

$$P_{DMAX} = V_S \times I_S + \Sigma[(V_S - V_{OUTi}) \times I_{LOADi}]$$

when sourcing, and:

$$P_{DMAX} = V_S \times I_S + \Sigma(V_{OUTi} \times I_{LOADi})$$

when sinking.

Where:

- i = 18
- V<sub>S</sub> = Supply voltage
- I<sub>S</sub> = Quiescent current
- V<sub>OUTi</sub> = Output voltage of the i channel
- I<sub>LOADi</sub> = Load current of the i channel

By setting the two P<sub>DMAX</sub> equations equal to each other, we can solve for the R<sub>LOADS</sub> to avoid the device overheat. The package power dissipation curves provide a convenient way to see if the device will overheat.

### THERMAL SHUTDOWN

The EL5625 has an internal thermal shutdown circuitry that prevents overheating of the part. When the junction temperature goes up to about 150°C, the part will be disabled. When the junction temperature drops down to about 120°C, the part will be enabled. With this feature, any short circuit at the outputs will enable the thermal shutdown circuitry to disable the part.

### POWER SUPPLY BYPASSING AND PRINTED CIRCUIT BOARD LAYOUT

Good printed circuit board layout is necessary for optimum performance. A low impedance and clean analog ground plane should be used for the EL5625. The traces from the two ground pins to the ground plane must be very short. The thermal pad of the EL5625 should be connected to the analog ground plane. Lead length should be as short as possible and all power supply pins must be well bypassed. A 0.1μF ceramic capacitor must be placed very close to the V<sub>S</sub>, V<sub>REFH</sub>, V<sub>REFL</sub>, and CAP pins. A 4.7μF local bypass tantalum capacitor should be placed to the V<sub>S</sub>, V<sub>REFH</sub>, and V<sub>REFL</sub> pins.

© Copyright Intersil Americas LLC 2006-2008. All Rights Reserved.  
All trademarks and registered trademarks are the property of their respective owners.

For additional products, see [www.intersil.com/en/products.html](http://www.intersil.com/en/products.html)

Intersil products are manufactured, assembled and tested utilizing ISO9001 quality systems as noted in the quality certifications found at [www.intersil.com/en/support/qualandreliability.html](http://www.intersil.com/en/support/qualandreliability.html)

*Intersil products are sold by description only. Intersil may modify the circuit design and/or specifications of products at any time without notice, provided that such modification does not, in Intersil's sole judgment, affect the form, fit or function of the product. Accordingly, the reader is cautioned to verify that datasheets are current before placing orders. Information furnished by Intersil is believed to be accurate and reliable. However, no responsibility is assumed by Intersil or its subsidiaries for its use; nor for any infringements of patents or other rights of third parties which may result from its use. No license is granted by implication or otherwise under any patent or patent rights of Intersil or its subsidiaries.*

For information regarding Intersil Corporation and its products, see [www.intersil.com](http://www.intersil.com)

**QFN (Quad Flat No-Lead) Package Family**

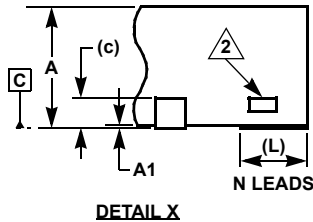
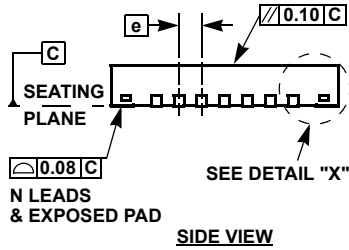
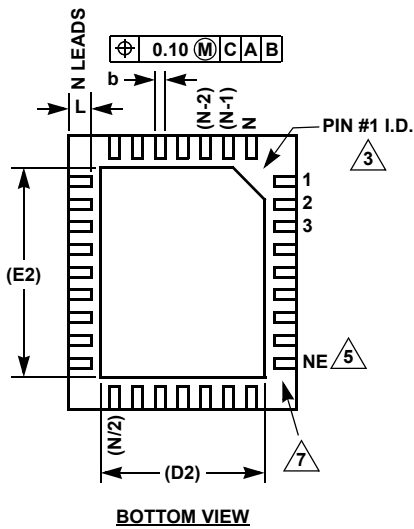
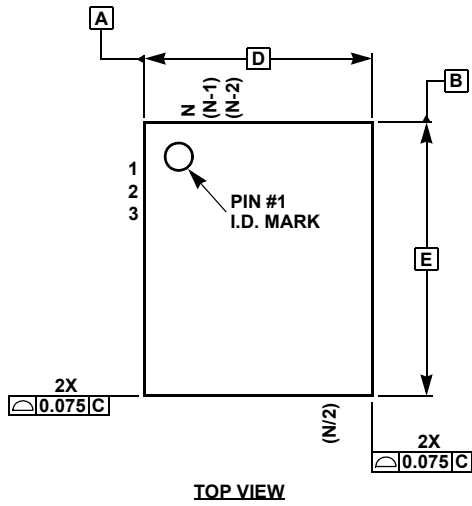

**MDP0046**

**QFN (QUAD FLAT NO-LEAD) PACKAGE FAMILY  
(COMPLIANT TO JEDEC MO-220)**

| SYMBOL | MILLIMETERS |       |       |           | TOLERANCE   | NOTES |
|--------|-------------|-------|-------|-----------|-------------|-------|
|        | QFN44       | QFN38 | QFN32 |           |             |       |
| A      | 0.90        | 0.90  | 0.90  | 0.90      | ±0.10       | -     |
| A1     | 0.02        | 0.02  | 0.02  | 0.02      | +0.03/-0.02 | -     |
| b      | 0.25        | 0.25  | 0.23  | 0.22      | ±0.02       | -     |
| c      | 0.20        | 0.20  | 0.20  | 0.20      | Reference   | -     |
| D      | 7.00        | 5.00  | 8.00  | 5.00      | Basic       | -     |
| D2     | 5.10        | 3.80  | 5.80  | 3.60/2.48 | Reference   | 8     |
| E      | 7.00        | 7.00  | 8.00  | 6.00      | Basic       | -     |
| E2     | 5.10        | 5.80  | 5.80  | 4.60/3.40 | Reference   | 8     |
| e      | 0.50        | 0.50  | 0.80  | 0.50      | Basic       | -     |
| L      | 0.55        | 0.40  | 0.53  | 0.50      | ±0.05       | -     |
| N      | 44          | 38    | 32    | 32        | Reference   | 4     |
| ND     | 11          | 7     | 8     | 7         | Reference   | 6     |
| NE     | 11          | 12    | 8     | 9         | Reference   | 5     |

| SYMBOL | MILLIMETERS |       |       |      |       | TOLERANCE   | NOTES |
|--------|-------------|-------|-------|------|-------|-------------|-------|
|        | QFN28       | QFN24 | QFN20 |      | QFN16 |             |       |
| A      | 0.90        | 0.90  | 0.90  | 0.90 | 0.90  | ±0.10       | -     |
| A1     | 0.02        | 0.02  | 0.02  | 0.02 | 0.02  | +0.03/-0.02 | -     |
| b      | 0.25        | 0.25  | 0.30  | 0.25 | 0.33  | ±0.02       | -     |
| c      | 0.20        | 0.20  | 0.20  | 0.20 | 0.20  | Reference   | -     |
| D      | 4.00        | 4.00  | 5.00  | 4.00 | 4.00  | Basic       | -     |
| D2     | 2.65        | 2.80  | 3.70  | 2.70 | 2.40  | Reference   | -     |
| E      | 5.00        | 5.00  | 5.00  | 4.00 | 4.00  | Basic       | -     |
| E2     | 3.65        | 3.80  | 3.70  | 2.70 | 2.40  | Reference   | -     |
| e      | 0.50        | 0.50  | 0.65  | 0.50 | 0.65  | Basic       | -     |
| L      | 0.40        | 0.40  | 0.40  | 0.40 | 0.60  | ±0.05       | -     |
| N      | 28          | 24    | 20    | 20   | 16    | Reference   | 4     |
| ND     | 6           | 5     | 5     | 5    | 4     | Reference   | 6     |
| NE     | 8           | 7     | 5     | 5    | 4     | Reference   | 5     |

Rev 11 2/07

**NOTES:**

1. Dimensioning and tolerancing per ASME Y14.5M-1994.
2. Tiebar view shown is a non-functional feature.
3. Bottom-side pin #1 I.D. is a diepad chamfer as shown.
4. N is the total number of terminals on the device.
5. NE is the number of terminals on the "E" side of the package (or Y-direction).
6. ND is the number of terminals on the "D" side of the package (or X-direction). ND = (N/2)-NE.
7. Inward end of terminal may be square or circular in shape with radius (b/2) as shown.
8. If two values are listed, multiple exposed pad options are available. Refer to device-specific datasheet.