

REVISIONS				
P	LTR	DESCRIPTION	DATE	APVD
	A	NEW RELEASE	26NOV2018	GCM/JDB

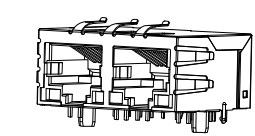
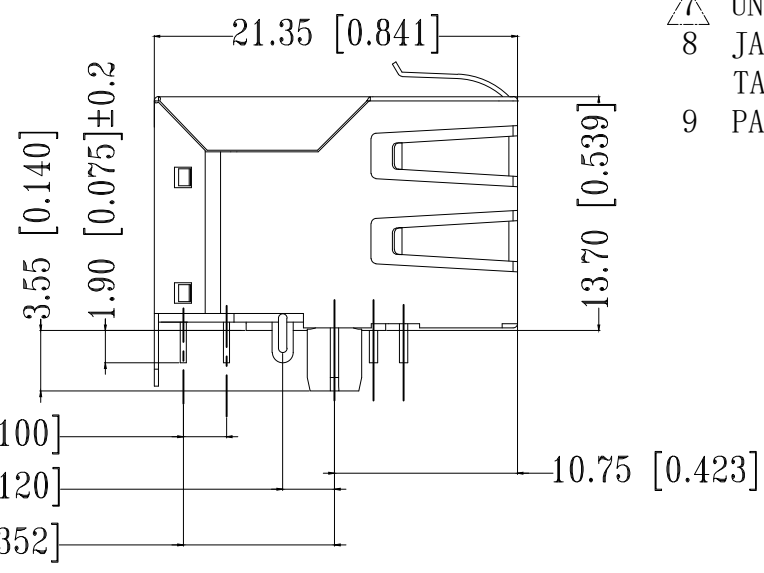
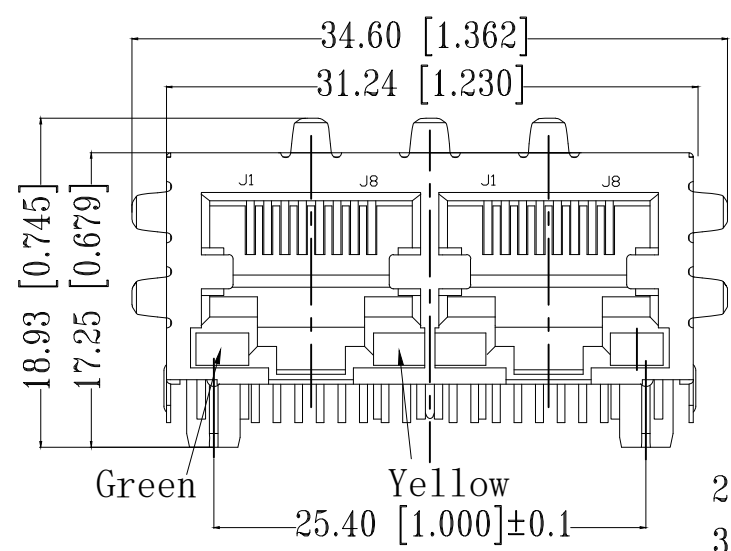
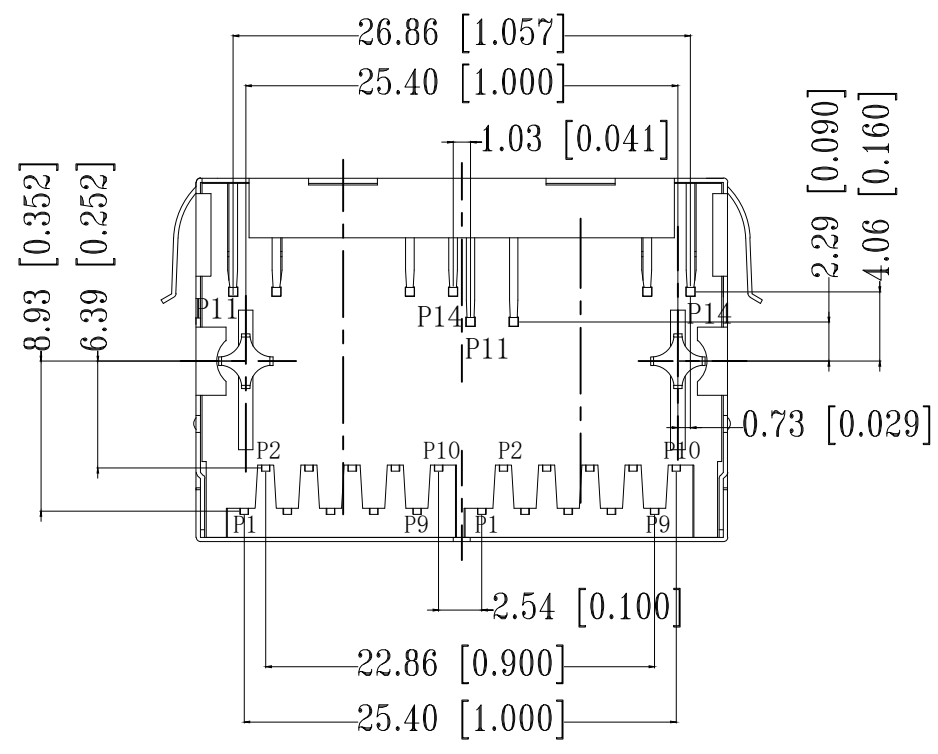

1:1

- △ CONNECTOR MATERIAL:
 HOUSING: LCP BLACK UL94 V-0
 INSERT: LCP BLACK UL94 V-0
 SHIELD: BRASS
 SHIELD PLATING: NICKEL
 CONTACT: COPPER ALLOY
 CONTACT PLATING: SELECTIVE GOLD, MIN. 0.76µm (30µinch) IN CONTACT AREA
 OVER MIN. 1.27µm (50µinch) NICKEL
 SOLDER PIN PLATING: 3.05µm (120µinch) TIN OVER 1.27µm (50µinch) NICKEL
 OVER ALL
 SHIELDING PIN PLATING: NICKEL
- 2 PIN NOT ELECTRICALLY CONNECTED MAYBE OMITTED SEE ELECTRICAL CIRCUIT DIAGRAM FOR OMITTED PINS
- 3 RJ45 CAVITIES CONFORM TO FCC RULES AND REGULATION PART 68
- 4 THE PART IS RECOMMENDED FOR REFLOW SOLDERING PROCESS PEAK SOLDERING: TEMPERATURE MAX. +260° C, MAX. 10s
- 5 OPERATING TEMPERATURE: T= -40° C TO +85° C
- 6 STORAGE TEMPERATURE: T= -40° C TO +85° C
- △ UNLESS OTHERWISE SPECIFIED, SEE TABLE FOR ALL DIMENSIONS TOLERANCES
- 8 JACK CONFIGURATION: 1 x 2
 TAB DIRECTION: DOWN
- 9 PACKAGING: TRAY ACCORDING TO PACKAGING SPECIFICATION 107-18116

TABLE OF TOLERANCE (mm)	
RANGE	TOLERANCE
0-10	±0.15
>10-40	±0.25
>40-70	±0.30
>70	±0.40

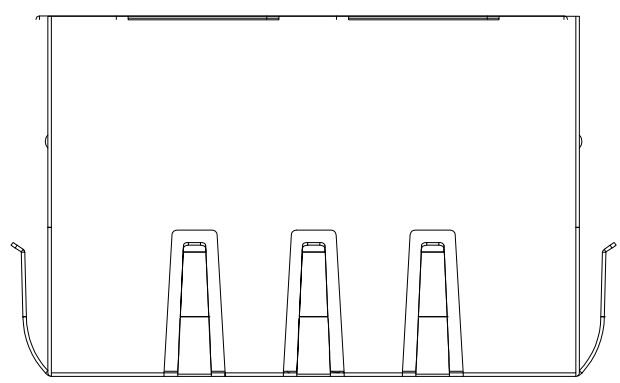

THIS DRAWING IS A CONTROLLED DOCUMENT.		DWN GANESH C M 26NOV2018	STE TE Connectivity	
DIMENSIONS: mm [INCHES]		CHK O. WIBORG 26NOV2018		
TOLERANCES UNLESS OTHERWISE SPECIFIED: △7		APVD J. DE BRUIJN 26NOV2018	NAME RJ45 JACK MAG. POE 10/100 LED 1x2	
MATERIAL △1		FINISH △1	PRODUCT SPEC 108-94694	RESTRICTED TO -
			APPLICATION SPEC 114-94556	SIZE A3
			WEIGHT	CAGE CODE 00779
			CUSTOMER DRAWING	DRAWING NO C-5-2337994-4
				SCALE 3:1
				SHEET 1 OF 3
				REV A



REVISIONS

P	LTR	DESCRIPTION	DATE	DWN	APVD
-	-	SEE SHEET 1	-	-	-

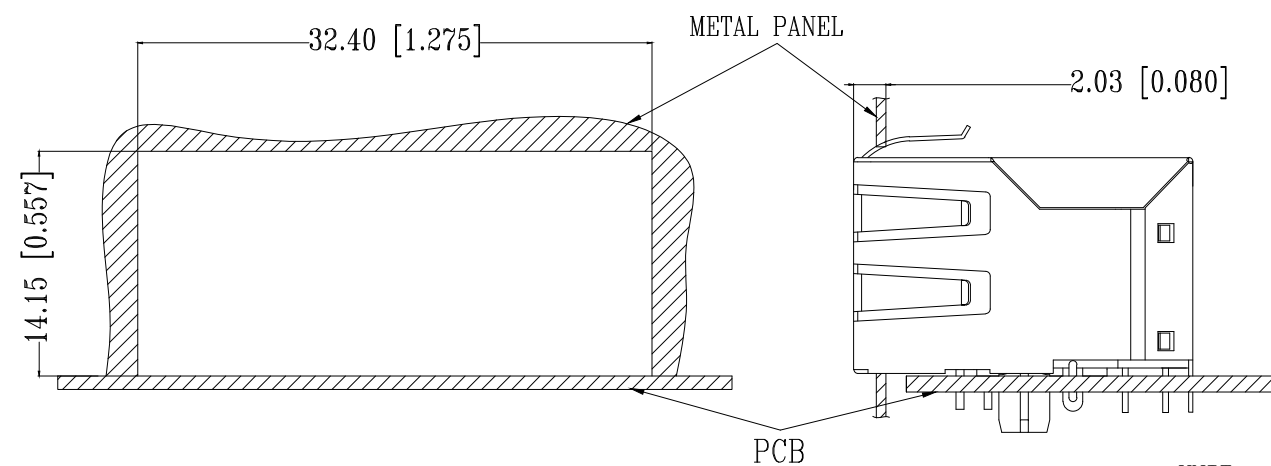
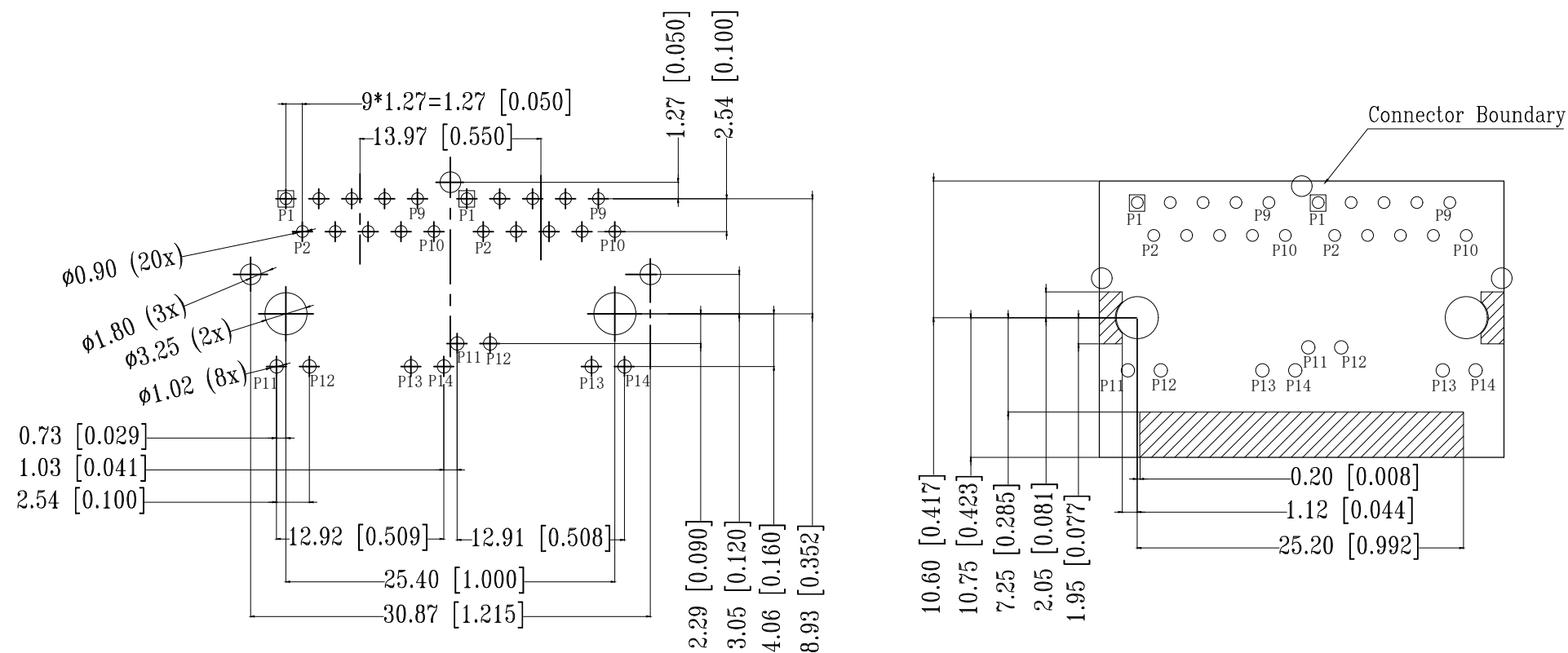
SUGGESTED PCB LAYOUT

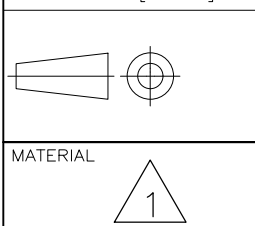

UNIT: mm / inch
TOLERANCES: ±0.10 / 0.004

THIS DRAWING IS A CONTROLLED DOCUMENT.		DWN GANESH C M 26NOV2018	 TE Connectivity		
DIMENSIONS: mm [INCHES]		CHK O. WIBORG 26NOV2018			
TOLERANCES UNLESS OTHERWISE SPECIFIED:		APVD J. DE BRUIJN 26NOV2018	NAME RJ45 JACK MAG. POE 10/100 LED 1x2		
 0 PLC ± - 1 PLC ± - 2 PLC ± - 3 PLC ± - 4 PLC ± - ANGLES ± -	 7	PRODUCT SPEC 108-94694	RESTRICTED TO		
		MATERIAL 1	FINISH 1	APPLICATION SPEC 114-94556	SIZE A3
CUSTOMER DRAWING			SCALE 3:1	SHEET 2 OF 3	REV A

REVISIONS

P	LTR	DESCRIPTION	DATE	DWN	APVD
-	-	SEE SHEET 1	-	-	-

ELECTRICAL CIRCUIT DIAGRAM

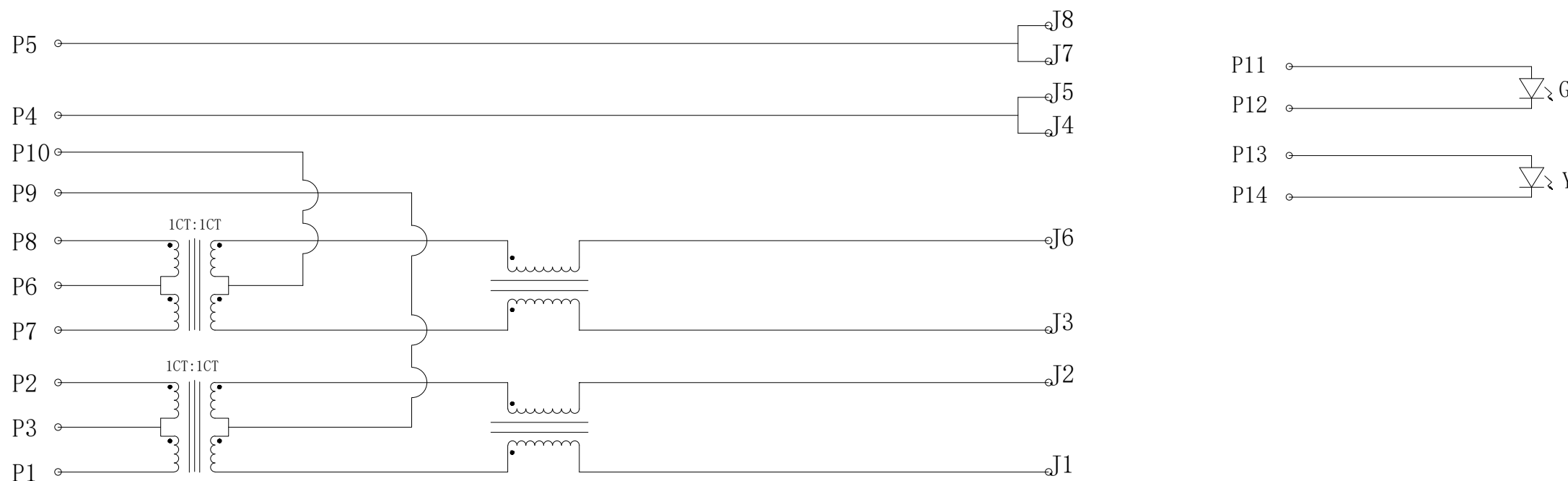

Pin	Green	Pin	Yellow
P11	+	P13	+
P12	-	P14	-

- 1.0 Turn Ratio @100kHz: (P1~P2):(J1~J2) = 1:1±2%
(P7~P8):(J3~J6) = 1:1±2%
- 2.0 Primary Inductance: 350µH MIN. @100kHz,0.1V 8mA DC BIAS
- 3.0 DC Resistance: 1.2 OHMS MAX.
- 4.0 Insertion Loss: 1-100MHz -1.2dB MAX.
- 5.0 Return Loss: 1-30MHz -16dB MIN.
30-60MHz -12dB MIN.
60-80MHz -10dB MIN.
- 6.0 CROSS TALK: 1-100MHz -27.1dB MIN.
- 7.0 COMMON TO COMMON MODE ATTENUATION: 1-100MHz -30dB MIN.
- 8.0 Isolation: PHY Side to Line Side: 500VAC
- 9.0 DC CURRENT/VOLTAGE RATING-PSE PINS: 720mA @57V(CONTINUOUS)

5-2337994-4
WWYY-xxxx

TE

FCC

CONTROL CODE
DATE CODE
"0213"
YY-YEAR
WW-WEEK

THIS DRAWING IS A CONTROLLED DOCUMENT.		DWN GANESH C M 26NOV2018	TE TE Connectivity		
DIMENSIONS: mm [INCHES]		CHK O. WIBORG 26NOV2018			
TOLERANCES UNLESS OTHERWISE SPECIFIED:		APVD J. DE BRUIJN 26NOV2018	NAME RJ45 JACK MAG. POE 10/100 LED 1x2		
0 PLC ± - 1 PLC ± - 2 PLC ± - 3 PLC ± - 4 PLC ± - ANGLES ± -		PRODUCT SPEC 108-94694	RESTRICTED TO		
MATERIAL 1		FINISH 1	APPLICATION SPEC 114-94556	SIZE A3	CAGE CODE 00779
		WEIGHT	DRAWING NO 5-2337994-4	SCALE 3:1	SHEET 3 OF 3
CUSTOMER DRAWING			REV A		