

Data sheet | Item number: 765-4204/100-000

4-Port IO-Link Master Class B; EtherCAT; DC 24 V / 2.0 A; 4xM12 connection; SlimLine

www.wago.com/765-4204/100-000



i Picture differs from the item.

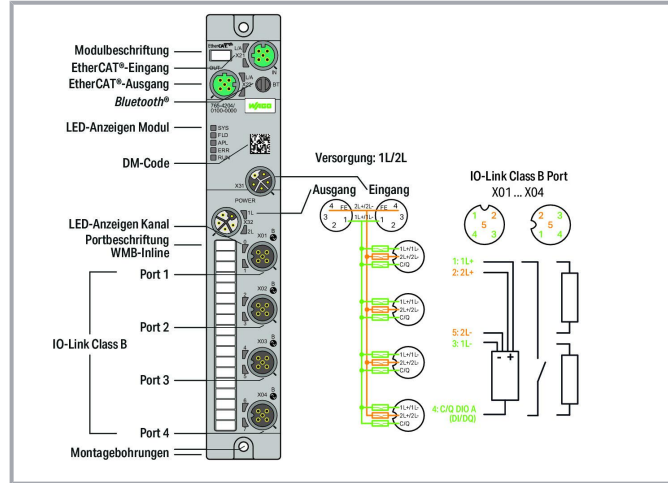

Data

Technical data

Fieldbus

Communication	EtherCAT® AoE, EoE, FoE
Connection technology: communication/fieldbus	2 x D-coded M12; 4-pole
Interface standard	10BASE-T/100BASE-TX; potential-free
Autonegotiation; autocrossover	yes

Device functions

Parameter	Input filter
-----------	--------------

Subject to changes. Please also observe the further product documentation!

WAGO GmbH & Co. KG
 Hansastr. 27
 32423 Minden
 Phone: +49571 887-0 | Fax: +49571 887-169
 Email: info.de@wago.com | Web: www.wago.com

Do you have any questions about our products?
 We are always happy to take your call at +49 (571) 887-44222.



	Output current Temperature
Diagnostics	Undervoltage; Overcurrent; Overload; Overtemperature
Device functions	Bluetooth® OPC UA Server
Visualization	Android/iOS app Web server

IO-Link master

IO-Link master classification	Class B; V1.1 specification
Port mode	IO-Link: autoconfig, manual, tool-based DI DO
Cycle time	400 µs (min.)
Operating mode	IO-Link master, DI or DO (adjustable for pin 4 per port); Supply voltage 2L (fixed for pin 2 per port)

IO-Link ports

Number of digital inputs	4
Number of digital outputs	4
Connection technology: inputs/outputs	4 x A-coded M12; 5-pole
Signal type (voltage)	24 VDC
Input characteristic	High-side switching
Input filter	0.2 ... 20 ms
Input characteristic	Type 3, per IEC 61131-2
Output current (per channel)	2 A (typ.) for DO
Supply current per port	1L (Pin 1): 1 A for IO-Link; 4 A (max.) for DIO; 2L (Pin 2): 4 A (max.)

Supply (module)

Connection technology: supply	2 x L-coded M12; 5-pole
Supply voltage	24 VDC (18 ... 31.2 V); 1L/2L
Current consumption (max.)	16000 mA
Current consumption (note)	per supply line; overload- and short-circuit-protected
Reverse voltage protection	Yes

Physical data

Width	35 mm / 1.378 inches
Height	30 mm / 1.181 inches

Subject to changes. Please also observe the further product documentation!

WAGO GmbH & Co. KG
Hansastr. 27
32423 Minden
Phone: +49571 887-0 | Fax: +49571 887-169
Email: info.de@wago.com | Web: www.wago.com

Do you have any questions about our products?
We are always happy to take your call at +49 (571) 887-44222.



Depth	210 mm / 8.268 inches
-------	-----------------------

Mechanical Data

Weight	380 g
--------	-------

Conformity marking	CE
--------------------	----

Environmental requirements

Ambient temperature (operation)	-25 ... +70 °C
---------------------------------	----------------

Ambient temperature (storage)	-40 ... +80 °C
-------------------------------	----------------

Protection type	IP67
-----------------	------

Protection class	III per EN 61140, IEC 61140, VDE 0140-1
------------------	---

Operating altitude	0 ... 2000 m / 0 ... 6562 ft
--------------------	------------------------------

Pollution degree	3 (EN 60664-1)
------------------	----------------

Overvoltage category	II (EN 60664-1)
----------------------	-----------------

Relative humidity (without condensation)	95 %
--	------

Vibration resistance	5g per IEC 60068-2-6
----------------------	----------------------

Shock resistance	Short-term: 50g/11 ms/half-sine per IEC 60068-2-27; Long-term: 30g/6 ms/half-sine per IEC 60068-2-29
------------------	--

EMC immunity to interference	per EN 61000-6-2
------------------------------	------------------

EMC emission of interference	per EN 61000-6-4
------------------------------	------------------

Commercial data

ETIM 8.0	EC001601
----------	----------

ETIM 7.0	EC001601
----------	----------

PU (SPU)	1 pcs
----------	-------

Country of origin	DE
-------------------	----

GTIN	4066966063172
------	---------------

Customs tariff number	85371098990
-----------------------	-------------

Environmental Product Compliance

RoHS Compliance Status	Compliant, No Exemption
------------------------	-------------------------

Required accessories

Cover

Cover	
-------	--



Item no.: 756-8102

M12 protective cap; for unused sockets

www.wago.com/756-8102

Subject to changes. Please also observe the further product documentation!

WAGO GmbH & Co. KG

Hansastr. 27

32423 Minden

Phone: +49571 887-0 | Fax: +49571 887-169

Email: info.de@wago.com | Web: www.wago.com

Do you have any questions about our products?

We are always happy to take your call at +49 (571) 887-44222.

	Item no.: 756-8103 M12 protective cap; for unused plugs	www.wago.com/756-8103
---	---	--







Marking accessories

Marking strip		
	Item no.: 2009-110 Marking strips; for Smart Printer; on reel; not stretchable; plain; snap-on type; white	www.wago.com/2009-110













Marker		
	Item no.: 2009-115 WMB-Inline; for Smart Printer; 1500 pieces on roll; stretchable 5 - 5.2 mm; plain; snap-on type; white	www.wago.com/2009-115

Tool		
Assembly tool		
	Item no.: 206-701 Torque wrench M8 and M12; Assembly kit	www.wago.com/206-701

Optional accessories

Cables and pluggable connectors		
Sensor/actuator cable		
	Item no.: 756-5402/050-010 Sensor/Actuator cable; M12A socket; straight; M12A plug; angled; 5-pole; Length: 1 m	www.wago.com/756-5402/050-010
	Item no.: 756-5311/050-015 Sensor/Actuator cable; M12A plug; straight; 5-pole; Length: 1.5 m	www.wago.com/756-5311/050-015
	Item no.: 756-5404/050-020 Sensor/Actuator cable; M12A socket; angled; M12A plug; angled; 5-pole; Length: 2 m	www.wago.com/756-5404/050-020
	Item no.: 756-5404/050-010 Sensor/Actuator cable; M12A socket; angled; M12A plug; angled; 5-pole; Length: 1 m	www.wago.com/756-5404/050-010
	Item no.: 756-5402/050-020 Sensor/Actuator cable; M12A socket; straight; M12A plug; angled; 5-pole; Length: 2 m	www.wago.com/756-5402/050-020
	Item no.: 756-5312/050-015 Sensor/Actuator cable; M12A plug; angled; 5-pole; Length: 1.5 m	www.wago.com/756-5312/050-015
	Item no.: 756-5312/050-050 Sensor/Actuator cable; M12A plug; angled; 5-pole; Length: 5 m	www.wago.com/756-5312/050-050

Subject to changes. Please also observe the further product documentation!

	Item no.: 756-5312/050-100 Sensor/Actuator cable; M12A plug; angled; 5-pole; Length: 10 m	www.wago.com/756-5312/050-100
	Item no.: 756-5403/050-020 Sensor/Actuator cable; M12A socket; angled; M12A plug; straight; 5-pole; Length: 2 m	www.wago.com/756-5403/050-020
	Item no.: 756-5403/050-010 Sensor/Actuator cable; M12A socket; angled; M12A plug; straight; 5-pole; Length: 1 m	www.wago.com/756-5403/050-010
	Item no.: 756-5311/050-100 Sensor/Actuator cable; M12A plug; straight; 5-pole; Length: 10 m	www.wago.com/756-5311/050-100
	Item no.: 756-5311/050-050 Sensor/Actuator cable; M12A plug; straight; 5-pole; Length: 5 m	www.wago.com/756-5311/050-050
	Item no.: 756-5401/050-010 Sensor/Actuator cable; M12A socket; straight; M12A plug; straight; 5-pole; Length: 1 m	www.wago.com/756-5401/050-010
	Item no.: 756-5401/050-020 Sensor/Actuator cable; M12A socket; straight; M12A plug; straight; 5-pole; Length: 2 m	www.wago.com/756-5401/050-020
Configurable connectors		
	Item no.: 756-9202/050-000 Fitted pluggable connector; 5-pole; M12 plug, straight, A-coded; Spring	www.wago.com/756-9202/050-000
	Item no.: 756-9205/050-000 Fitted pluggable connector; 5-pole; M12 plug, right angle; Spring	www.wago.com/756-9205/050-000
	Item no.: 756-9711/050-000 Fitted pluggable connector; 5-pole, shielded; M12 socket, straight; IDC technology	www.wago.com/756-9711/050-000
	Item no.: 756-9701/050-000 Fitted pluggable connector; 5-pole, shielded; M12 plug, straight; IDC technology	www.wago.com/756-9701/050-000
Configurable shielded connectors		
	Item no.: 756-9501/060-000 Fitted pluggable connector; 4-pole, shielded; M12 plug, straight, D-coded; Spring	www.wago.com/756-9501/060-000

Subject to changes. Please also observe the further product documentation!



Item no.: 756-9501/040-000
Accessories; M12 plug, right angle; 4-pole

www.wago.com/756-9501/040-000

Power cable



Item no.: 756-3501/050-075
Power cable; M12L socket; straight; 5-pole; Length: 7.5 m

www.wago.com/756-3501/050-075



Item no.: 756-3501/050-100
Power cable; M12L socket; straight; 5-pole; Length: 10 m

www.wago.com/756-3501/050-100



Item no.: 756-3501/050-150
Power cable; M12L socket; straight; 5-pole; Length: 15 m

www.wago.com/756-3501/050-150



Item no.: 756-3501/050-050
Power cable; M12L socket; straight; 5-pole; Length: 5 m

www.wago.com/756-3501/050-050



Item no.: 756-3502/050-050
Power cable; M12L socket; angled; 5-pole; Length: 5 m

www.wago.com/756-3502/050-050



Item no.: 756-3502/050-150
Power cable; M12L socket; angled; 5-pole; Length: 15 m

www.wago.com/756-3502/050-150



Item no.: 756-3502/050-075
Power cable; M12L socket; angled; 5-pole; Length: 7.5 m

www.wago.com/756-3502/050-075



Item no.: 756-3502/050-100
Power cable; M12L socket; angled; 5-pole; Length: 10 m

www.wago.com/756-3502/050-100



Item no.: 756-3503/050-075
Power cable; M12L plug; straight; 5-pole; Length: 7.5 m













www.wago.com/756-3503/050-075















Item no.: 756-3503/050-150
Power cable; M12L plug; straight; 5-pole; Length: 15 m

www.wago.com/756-3503/050-150

Subject to changes. Please also observe the further product documentation!

	Item no.: 756-3503/050-100 Power cable; M12L plug; straight; 5-pole; Length: 10 m	www.wago.com/756-3503/050-100
	Item no.: 756-3505/050-003 Power cable; M12L socket; straight; M12L plug; straight; 5-pole; Length: 0.3 m	www.wago.com/756-3505/050-003
	Item no.: 756-3505/050-005 Power cable; M12L socket; straight; M12L plug; straight; 5-pole; Length: 0.5 m	www.wago.com/756-3505/050-005
	Item no.: 756-3505/050-020 Power cable; M12L socket; straight; M12L plug; straight; 5-pole; Length: 2 m	www.wago.com/756-3505/050-020
	Item no.: 756-3505/050-010 Power cable; M12L socket; straight; M12L plug; straight; 5-pole; Length: 1 m	www.wago.com/756-3505/050-010
	Item no.: 756-3505/050-050 Power cable; M12L socket; straight; M12L plug; straight; 5-pole; Length: 5 m	www.wago.com/756-3505/050-050
	Item no.: 756-3505/050-075 Power cable; M12L socket; straight; M12L plug; straight; 5-pole; Length: 7.5 m	www.wago.com/756-3505/050-075
	Item no.: 756-3505/050-100 Power cable; M12L socket; straight; M12L plug; straight; 5-pole; Length: 10 m	www.wago.com/756-3505/050-100
	Item no.: 756-3506/050-100 Power cable; M12L socket; angled; M12L plug; angled; 5-pole; Length: 10 m	www.wago.com/756-3506/050-100
	Item no.: 756-3506/050-075 Power cable; M12L socket; angled; M12L plug; angled; 5-pole; Length: 7.5 m	www.wago.com/756-3506/050-075
	Item no.: 756-3506/050-150 Power cable; M12L socket; angled; M12L plug; angled; 5-pole; Length: 15 m	www.wago.com/756-3506/050-150
	Item no.: 756-3501/050-020 Power cable; M12L socket; straight; 5-pole; Length: 2 m	www.wago.com/756-3501/050-020

Subject to changes. Please also observe the further product documentation!

	Item no.: 756-3502/050-020 Power cable; M12L socket; angled; 5-pole; Length: 2 m	www.wago.com/756-3502/050-020
	Item no.: 756-3503/050-020 Power cable; M12L plug; straight; 5-pole; Length: 2 m	www.wago.com/756-3503/050-020
	Item no.: 756-3503/050-050 Power cable; M12L plug; straight; 5-pole; Length: 5 m	www.wago.com/756-3503/050-050
	Item no.: 756-3504/050-020 Power cable; M12L plug; angled; 5-pole; Length: 2 m	www.wago.com/756-3504/050-020
	Item no.: 756-3504/050-050 Power cable; M12L plug; angled; 5-pole; Length: 5 m	www.wago.com/756-3504/050-050
	Item no.: 756-3504/050-075 Power cable; M12L plug; angled; 5-pole; Length: 7.5 m	www.wago.com/756-3504/050-075
	Item no.: 756-3504/050-100 Power cable; M12L plug; angled; 5-pole; Length: 10 m	www.wago.com/756-3504/050-100
	Item no.: 756-3504/050-150 Power cable; M12L plug; angled; 5-pole; Length: 15 m	www.wago.com/756-3504/050-150
	Item no.: 756-3505/050-150 Power cable; M12L socket; straight; M12L plug; straight; 5-pole; Length: 15 m	www.wago.com/756-3505/050-150
	Item no.: 756-3506/050-003 Power cable; M12L socket; angled; M12L plug; angled; 5-pole; Length: 0.3 m	www.wago.com/756-3506/050-003
	Item no.: 756-3506/050-005 Power cable; M12L socket; angled; M12L plug; angled; 5-pole; Length: 0.5 m	www.wago.com/756-3506/050-005
	Item no.: 756-3506/050-020 Power cable; M12L socket; angled; M12L plug; angled; 5-pole; Length: 2 m	www.wago.com/756-3506/050-020

Subject to changes. Please also observe the further product documentation!



Item no.: 756-3506/050-010
Power cable; M12L socket; angled; M12L plug; angled; 5-pole; Length: 1 m

www.wago.com/756-3506/050-010



Item no.: 756-3506/050-050
Power cable; M12L socket; angled; M12L plug; angled; 5-pole; Length: 5 m

www.wago.com/756-3506/050-050

Distribution connector



Item no.: 756-9301/050-000
Accessories; 5-pole

www.wago.com/756-9301/050-000

ETHERNET/PROFINET cable



Item no.: 756-1202/060-200
ETHERNET cable; M12D plug; angled; 4-pole; Length: 20 m

www.wago.com/756-1202/060-200



Item no.: 756-1201/060-100
ETHERNET cable; M12D plug; straight; 4-pole; Length: 10 m

www.wago.com/756-1201/060-100



Item no.: 756-1201/060-050
ETHERNET cable; M12D plug; straight; 4-pole; Length: 5 m

www.wago.com/756-1201/060-050



Item no.: 756-1203/060-050
ETHERNET cable; M12D plug; straight; M12D plug; straight; 4-pole; Length: 5 m

www.wago.com/756-1203/060-050



Item no.: 756-1203/060-020
ETHERNET cable; M12D plug; straight; M12D plug; straight; 4-pole; Length: 2 m

www.wago.com/756-1203/060-020



Item no.: 756-1202/060-020
ETHERNET cable; M12D plug; angled; 4-pole; Length: 2 m

www.wago.com/756-1202/060-020



Item no.: 756-1201/060-200
ETHERNET cable; M12D plug; straight; 4-pole; Length: 20 m











www.wago.com/756-1201/060-200



Item no.: 756-1204/060-050
ETHERNET cable; M12D plug; angled; M12D plug; angled; 4-pole; Length: 5 m

www.wago.com/756-1204/060-050

Subject to changes. Please also observe the further product documentation!

	Item no.: 756-1204/060-100 ETHERNET cable; M12D plug; angled; M12D plug; angled; 4-pole; Length: 10 m	www.wago.com/756-1204/060-100
	Item no.: 756-1204/060-200 ETHERNET cable; M12D plug; angled; M12D plug; angled; 4-pole; Length: 20 m	www.wago.com/756-1204/060-200
	Item no.: 756-1203/060-200 ETHERNET cable; M12D plug; straight; M12D plug; straight; 4-pole; Length: 20 m	www.wago.com/756-1203/060-200
	Item no.: 756-1203/060-100 ETHERNET cable; M12D plug; straight; M12D plug; straight; 4-pole; Length: 10 m	www.wago.com/756-1203/060-100
	Item no.: 756-1204/060-010 ETHERNET cable; M12D plug; angled; M12D plug; angled; 4-pole; Length: 1 m	www.wago.com/756-1204/060-010
	Item no.: 756-1204/060-030 ETHERNET cable; M12D plug; angled; M12D plug; angled; 4-pole; Length: 3 m	www.wago.com/756-1204/060-030
	Item no.: 756-1204/060-020 ETHERNET cable; M12D plug; angled; M12D plug; angled; 4-pole; Length: 2 m	www.wago.com/756-1204/060-020
	Item no.: 756-1202/060-050 ETHERNET cable; M12D plug; angled; 4-pole; Length: 5 m	www.wago.com/756-1202/060-050
	Item no.: 756-1202/060-100 ETHERNET cable; M12D plug; angled; 4-pole; Length: 10 m	www.wago.com/756-1202/060-100
	Item no.: 756-1201/060-020 ETHERNET cable; M12D plug; straight; 4-pole; Length: 2 m	www.wago.com/756-1201/060-020

Downloads Documentation

Manual

Product Manual 4-Port-IO Link Master Class B; EtherCAT; 24 VDC / 2.0 A; 4xM12 Connection; SlimLine	V 2.0.0 2022 Jul 19	pdf 8.3 MB	Download
---	------------------------	---------------	----------

Subject to changes. Please also observe the further product documentation!



Instruction Leaflet

I/O System Field package insert	2021 Dec 15	pdf 1.1 MB	Download
---------------------------------	-------------	---------------	----------

System Description

WAGO I/O System Field; General Product Information		pdf 1.0 MB	Download
--	--	---------------	----------

Application Notes

Application Note e!COCKPIT

e!COCKPIT Application Note EtherCAT IO-Field (a2022003)	1.0.0	pptx	Download
WAGO EtherCAT Master, EoE access with IO-Field devices	2023 Mar 23	2.2 MB	

Engineering-Software

WAGO IO-Link Configurator

WAGO IO-Link Configurator	V5.1.1-6618 2022 Feb 16	ZIP 91.8 MB	Download
---------------------------	----------------------------	----------------	----------

WAGO IO-Link Configurator allows configuration, parameterization, operation and monitoring of WAGO IO-Link Masters in the WAGO I/O System 750 and WAGO I/O System Field, and especially of the WAGO IO-Link devices connected to them.

Additionally, WAGO IO-Link Configurator can be used for complete configuration and operation of all IO-Link devices of third-party manufacturers, as long as they comply with the IO-Link specification. A product's process data can be visualized graphically and stored in trend curves. Up to eight elements can be selected for visualization, and the data can be recorded for up to 24 hours.

Device description files for the IO-Link Masters (IOLM) or IO-Link Devices (IODD) can be used to integrate new devices into the tool at any time. Convenient access to the IO-Link user organization's IODDfinder is available for the IODDs. This allows automated, selective download of IODDs when integrating new IO-Link devices. An integrated IODD viewer allows detailed insight into the IODD device description.

WAGO IO-Link Configurator can be used either as a standalone program or integrated into engineering systems with a TCI interface and WAGO-I/O-CHECK.

IO-Link Configurator can also be used to integrate the IO-Link Master (750-657) of the WAGO I/O System 750 Series and to access all the configurator's functions. This is made possible by the WAGO I/O System 750 IO-Link Adapter, which can be retrofitted. The WAGO I/O System 750 IO-Link Adapter requires the current version of WAGO IO-Link Configurator and a current version of WAGO-I/O-CHECK.

In addition, the download file contains the device descriptions for the respective fieldbus systems of the WAGO I/O System Field modules. These are pre-installed in the Configurator setup.

The WAGO IO-Link Configurator license is assigned to the specific PC on which it is installed (a workstation license).

Register now and test our engineering software for 30 days at no cost.

Subject to changes. Please also observe the further product documentation!

WAGO GmbH & Co. KG
Hansastr. 27
32423 Minden
Phone: +49571 887-0 | Fax: +49571 887-169
Email: info.de@wago.com | Web: www.wago.com

Do you have any questions about our products?
We are always happy to take your call at +49 (571) 887-44222.



Runtime Software

Firmware

0765-x2xx, EtherCat IO-Field	V 04	zip	Download
WAGO_FW0765-x2xx_V01010021_IX04	2023 Feb 2	1.6 MB	

CAD/CAE-Data

CAD data

2D/3D Models 765-4204/100-000	URL	Download
-------------------------------	-----	----------

CAE data

EPLAN Data Portal 765-4204/100-000	URL	Download
------------------------------------	-----	----------

Device Files

Device Description File

Gerätebeschreibungsdateien 765-42xx, 765-12xx, EtherCAT	V1_1_0_17	zip 73.6 kB	Download
---	-----------	----------------	----------

Environmental Product Compliance

Compliance Search

Environmental Product Compliance 765-4204/100-000	URL	Download
4-Port IO-Link Master Class B; EtherCAT; DC 24 V / 2.0 A; 4xM12 connection; SlimLine		

Installation Notes

Product family

WAGO I/O System Field
[Show all products from the family](#)

Subject to changes. Please also observe the further product documentation!