

Assembly Instructions for - 37177

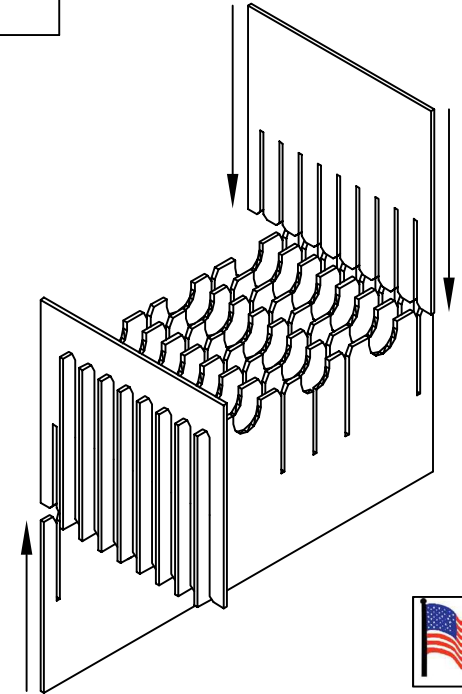
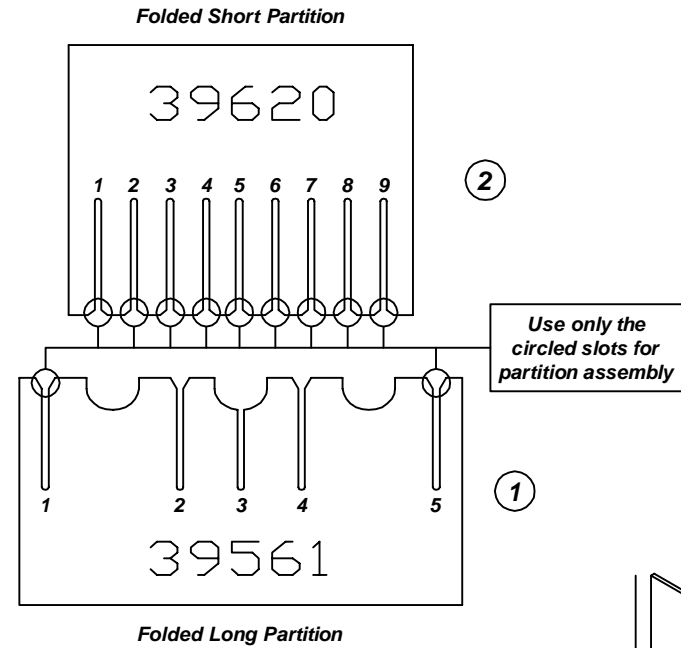
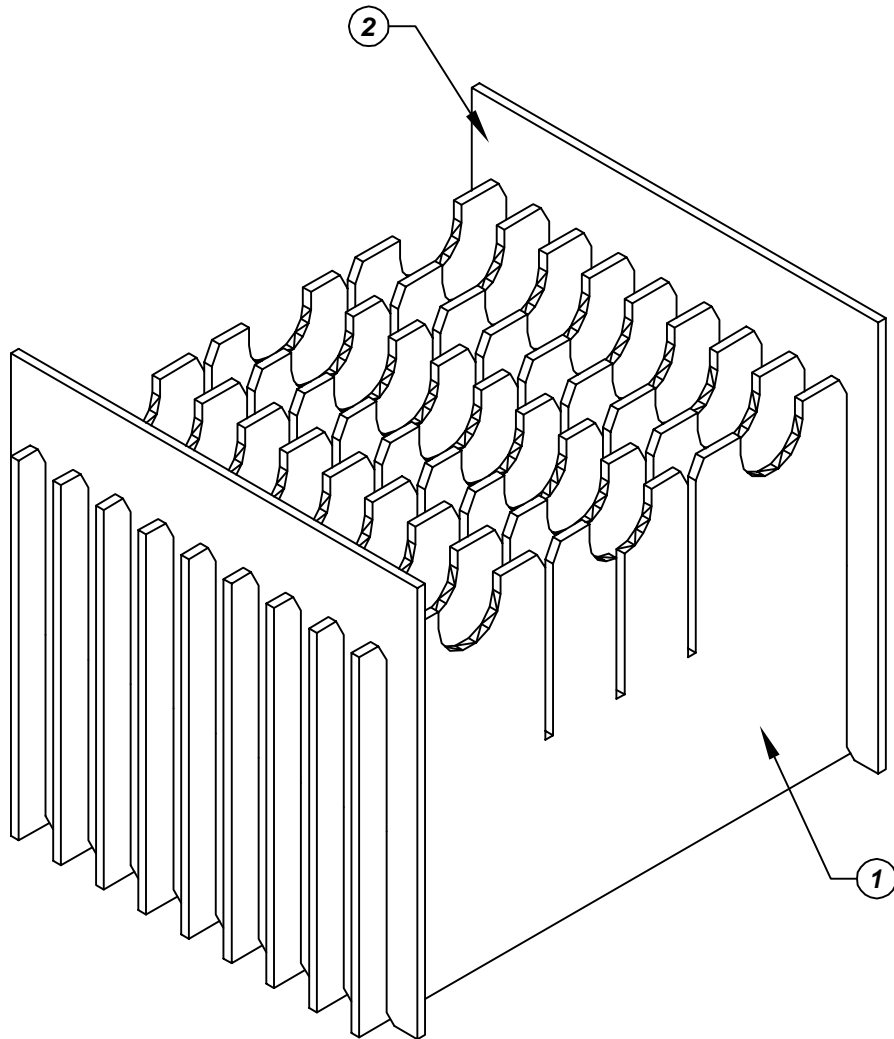

Made in America

F/N ①	Part # 39561	Dimensions: 21-1/2" x 16-7/8"	Description: 439/403/434-LP Long Partition	Qty: 9
F/N ②	Part # 39620	Dimensions: 25-1/2" x 13-1/8"	Description: 403-SP Short Partition	Qty: 2

37177 - 10 Cell Inplant Handler Cell Size - 12-5/8" x 14-5/8" x 1"

Notes:
For use with the following storage container & lid:
37503 - Storage Container
37551 - Lid

PROTEKTIVE PAK
13520 MONTE VISTA AVENUE, CHINO, CA 91710
PHONE (909) 627-2578, FAX (909) 363-7331
ProtektivePak.com

PROTEKTIVE PAK
BURIED CONDUCTIVE LAYER

DRAWING NUMBER
IPH-37177

DATE
Dec.
2007