

EZO-PRS™

Embedded Pressure Sensor

Reads	Pressure (Gauge) psi (0 - 74.000) Default atm (0 - 5.03) bar (0 - 5.102) kPa (0 - 510.212) inches of water (0 - 2,050.36") cm of water (0 - 5,202.71 cm)
Response time	1 reading per second
Resolution	0.001
Accuracy	+/- 2% (1 psi)
Threaded connection	1/4" NPT
Cable	1 meter / 5 lead
Data protocol	UART & I²C
Default I ² C address	106 (0x6A)
Data format	ASCII
Operating voltage	3.3V – 5V
Water resistant/dust proof	IP67



Table of contents

EZO-PRS™ dimensions	3	Typical applications	6
Operating principle	4	Calibration theory	8
Power consumption	4	Pin out	8
Absolute max ratings	4	Default state	9
Gauge pressure vs Absolute pressure	5	Available data protocols	10

UART

UART mode	12
Receiving data from device	13
Sending commands to device	14
LED color definition	15
UART quick command page	16
LED control	17
Find	18
Continuous mode	19
Single reading mode	20
Alarm	21
Custom calibration	22
Add/remove decimal places	23
Pressure units	24
Naming device	25
Device information	26
Response codes	27
Reading device status	28
Sleep mode/low power	29
Change baud rate	30
Protocol lock	31
Factory reset	32
Change to I ² C mode	33
Manual switching to I ² C	34

I²C

I ² C mode	36
Sending commands	37
Requesting data	38
Response codes	39
LED color definition	40
I²C quick command page	41
LED control	42
Find	43
Taking reading	44
Alarm	45
Custom calibration	46
Add/remove decimal places	47
Pressure units	48
Naming device	49
Device information	50
Reading device status	51
Sleep mode/low power	52
Protocol lock	53
I ² C address change	54
Factory reset	55
Change to UART mode	56
Manual switching to UART	57

Datasheet change log	58
Firmware updates	58
Warranty	59

EZO-PRS™ dimensions

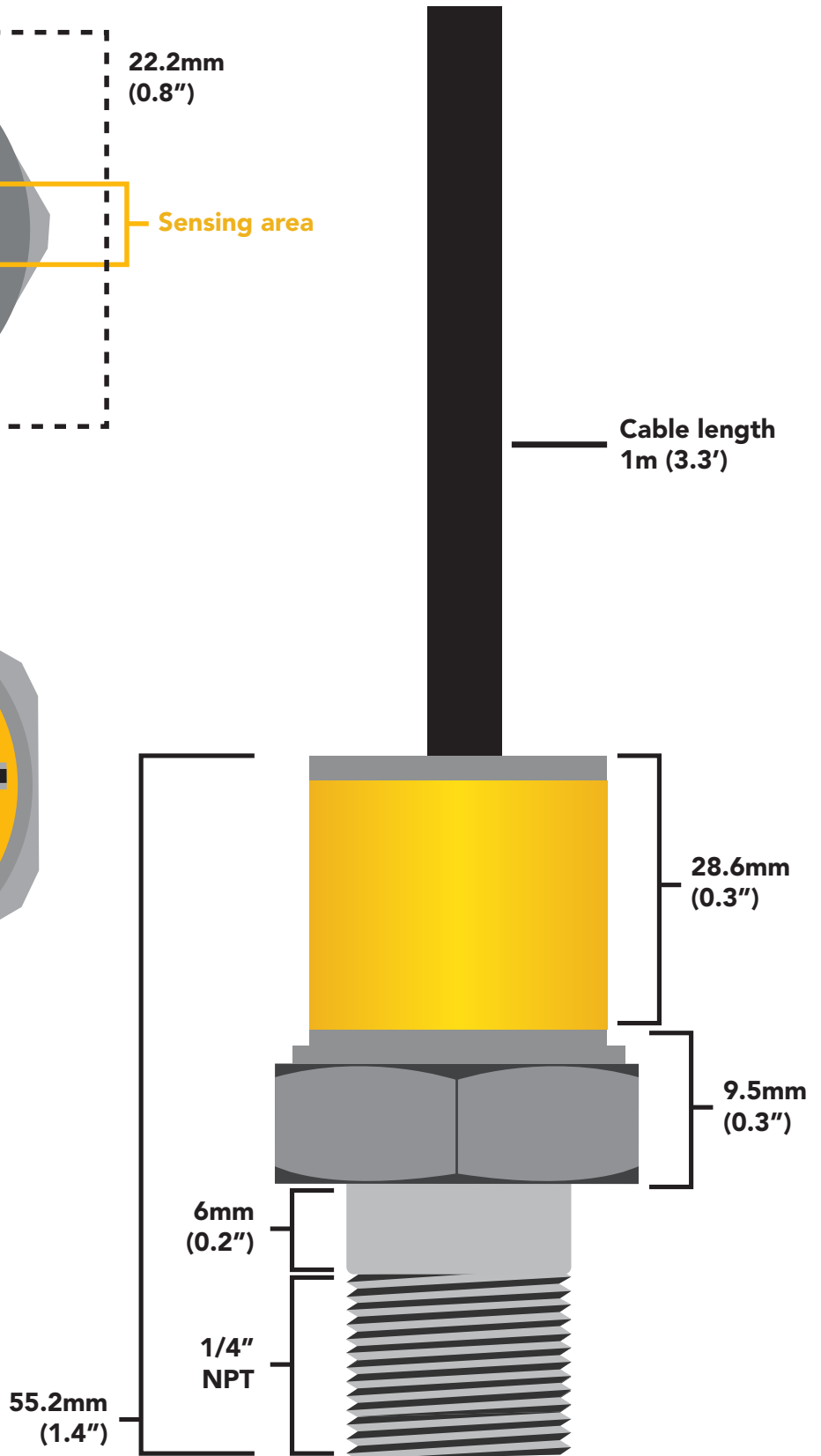
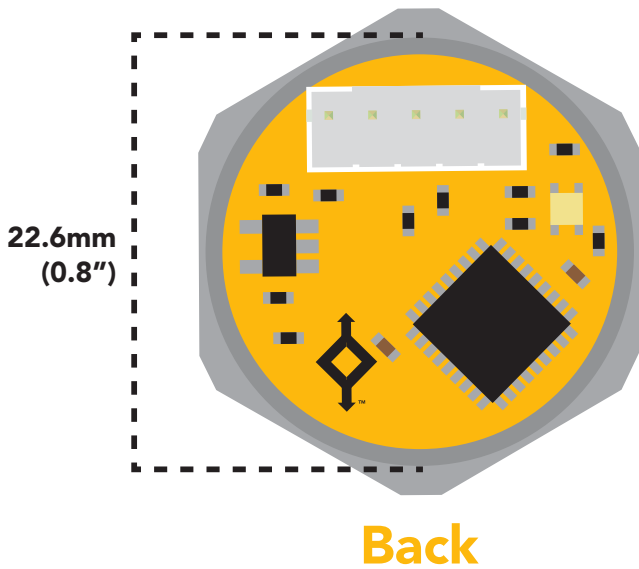
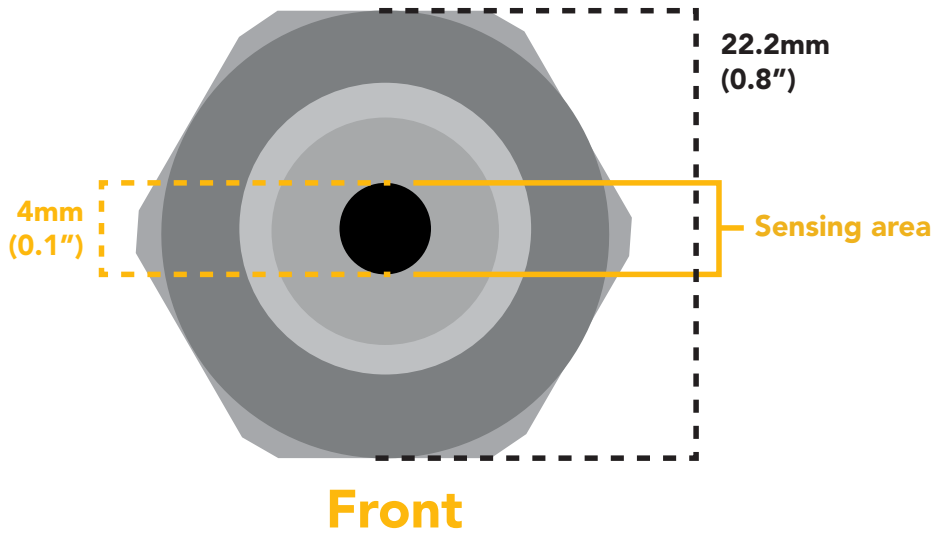

Weight 108g

Body 304L Stainless Steel

Durability IP67

Operating principle

Internally the pressure sensor uses a piezoresistive semiconducting element. The semiconducting element (*a silicon wafer*) changes its resistance in proportion to pressure. As the pressure increases the atomic spacing of the silicon atoms decreases, this in turn lowers the resistance of the silicon wafer.

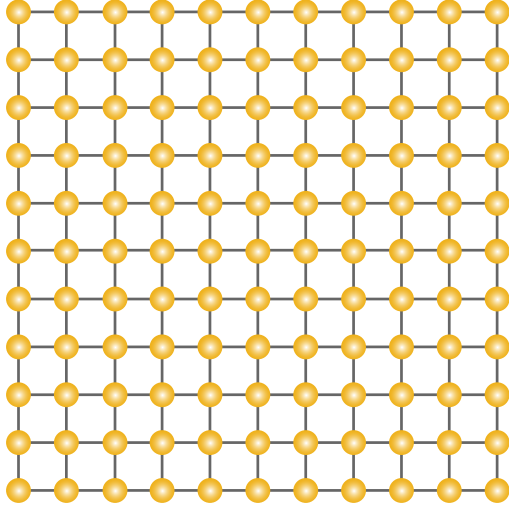

Atmospheric pressure

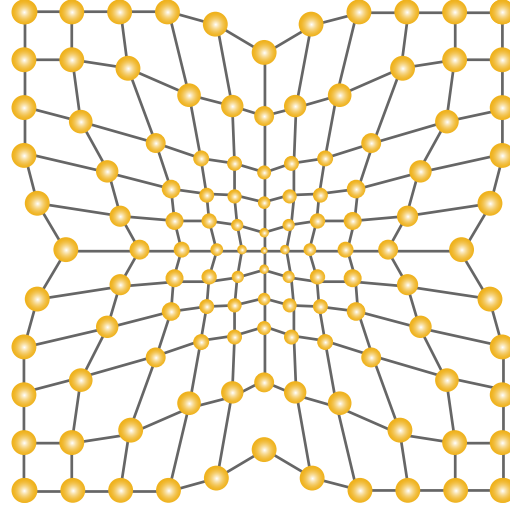

50 PSI

Chemical compatibility

Any gas, liquid or oil compatible with 304L Stainless Steel.

Power consumption

	LED	MAX	STANDBY	SLEEP
5V	ON	14.25 mA	14.25 mA	1.66 mA
	OFF	14.00 mA	14.00 mA	
3.3V	ON	13.21 mA	13.21 mA	0.85 mA
	OFF	12.95 mA	12.95 mA	

Absolute max ratings

Parameter	MIN	TYP	MAX
Storage temperature (EZO-Pressure)	-65 °C		125 °C
Operational temperature (EZO-Pressure)	-40 °C	25 °C	105 °C
VCC	3.3V	5V	5.5V
Pressure limit (sensor damage)			~150 psi
Burst Pressure			7,500 psi

Gauge pressure vs Absolute pressure

The EZO-PRS™ reads ***gauge pressure*** only.

Gauge pressure

A gauge pressure sensor reads pressure relative to atmospheric pressure.

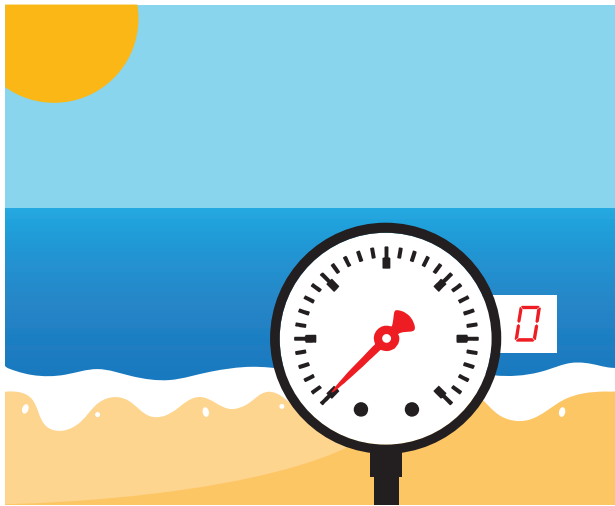

A gauge pressure sensor will always read atmospheric pressure as 0.

Absolute pressure

An absolute pressure sensor reads pressure relative to the vacuum of space.

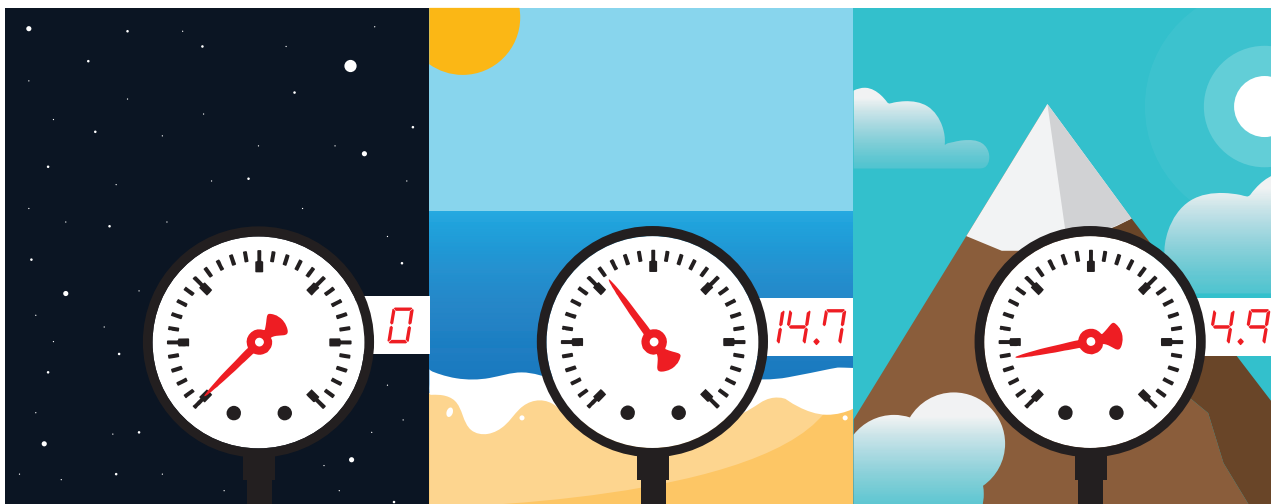

Typical applications

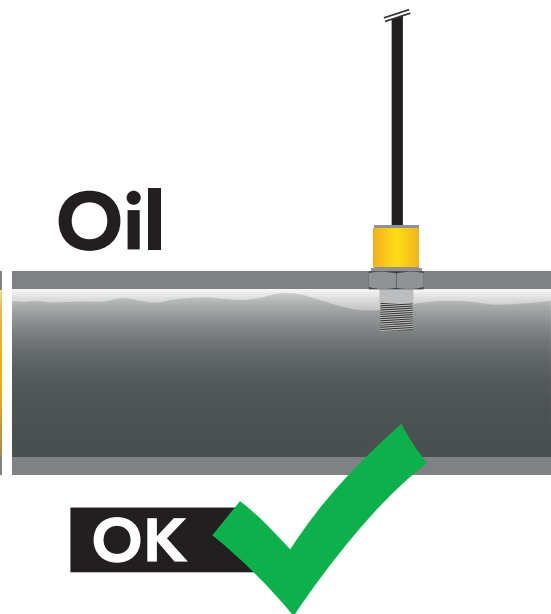
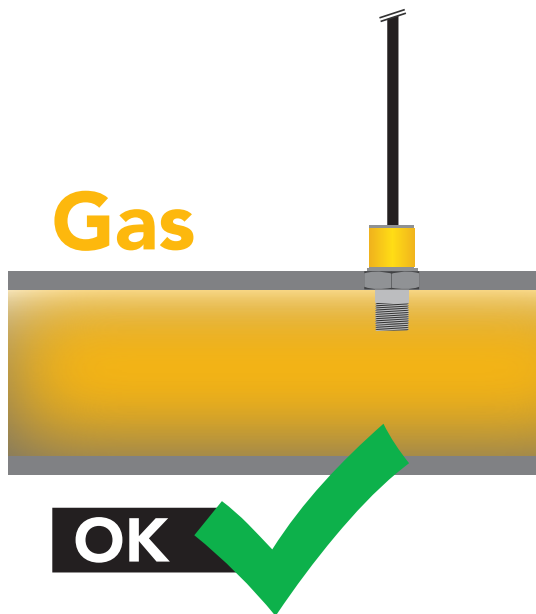
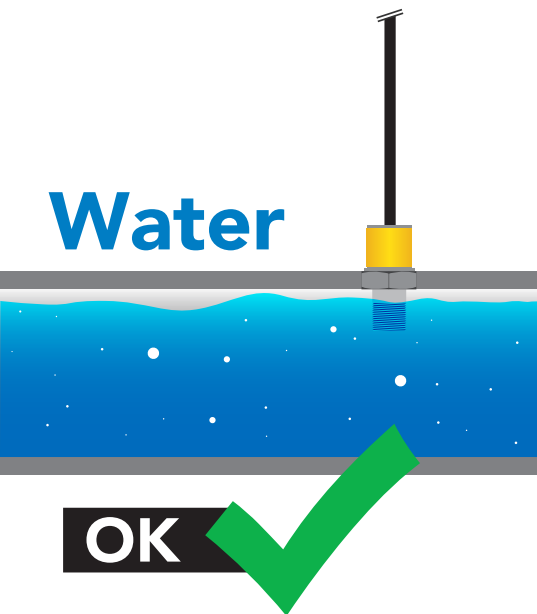
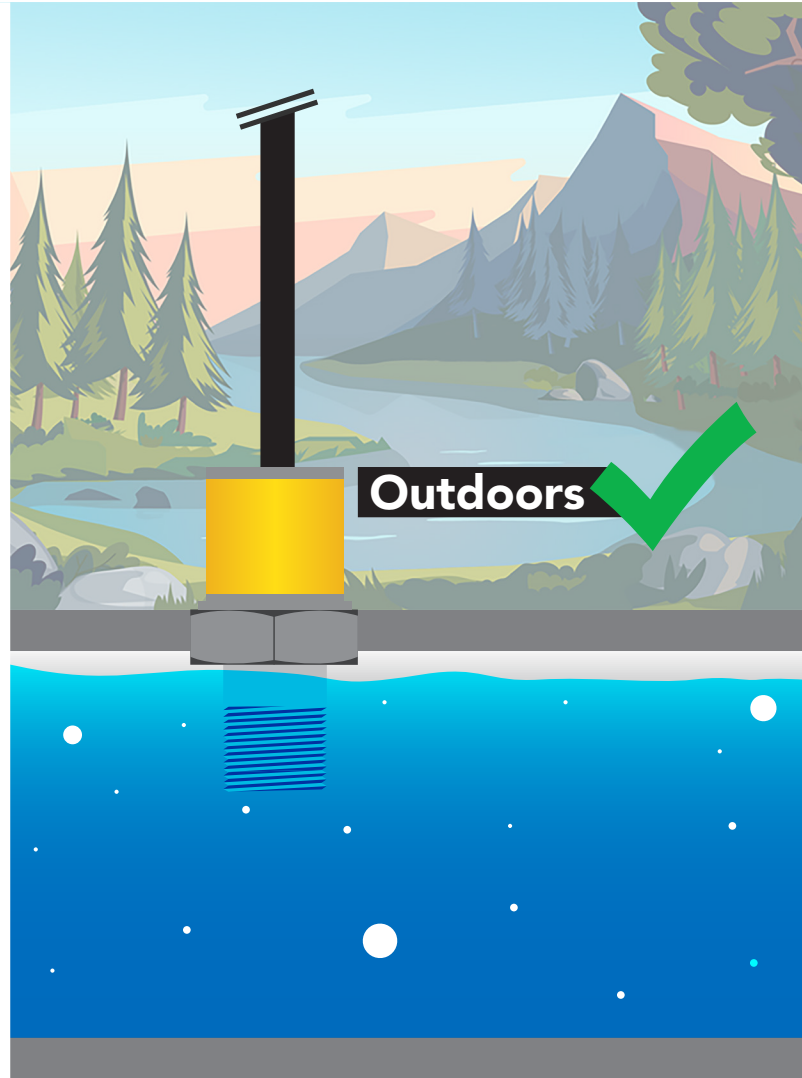

Typical applications

Measuring the water level in a tank

Setting the EZO-PRS™ to measure the height of water is a great way to measure the volume of a tank. See page [24](#) or [48](#) for more info.

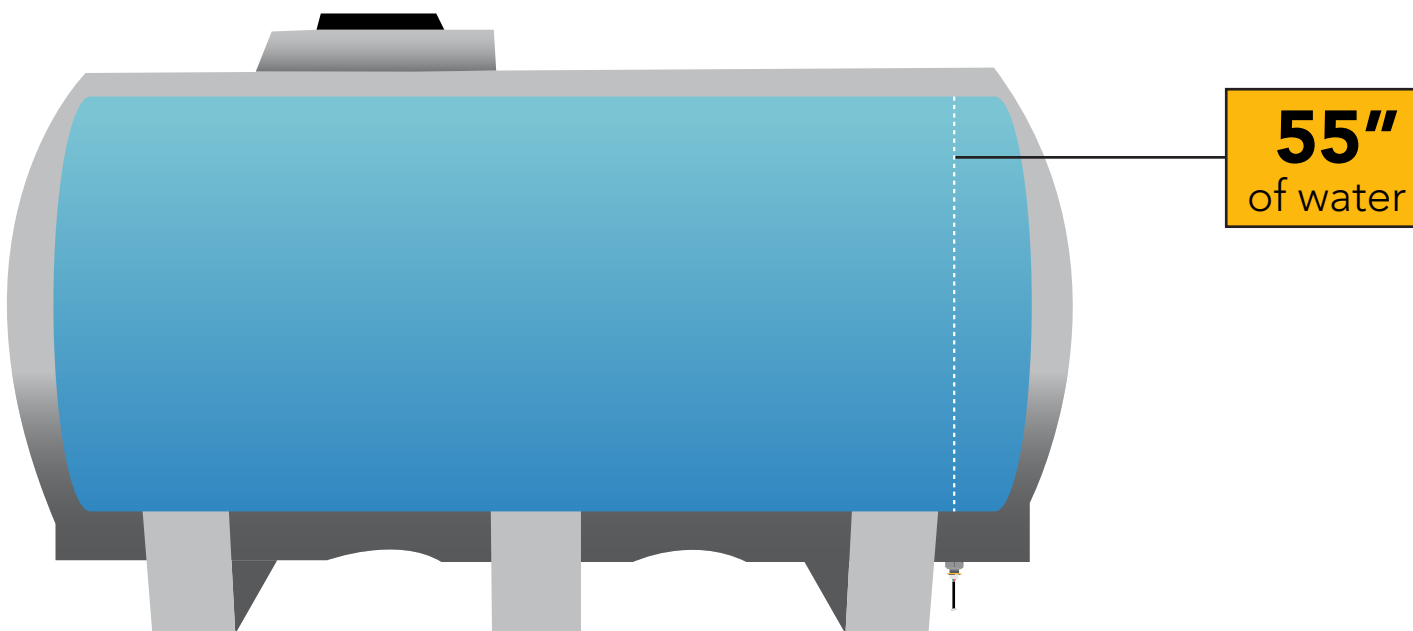
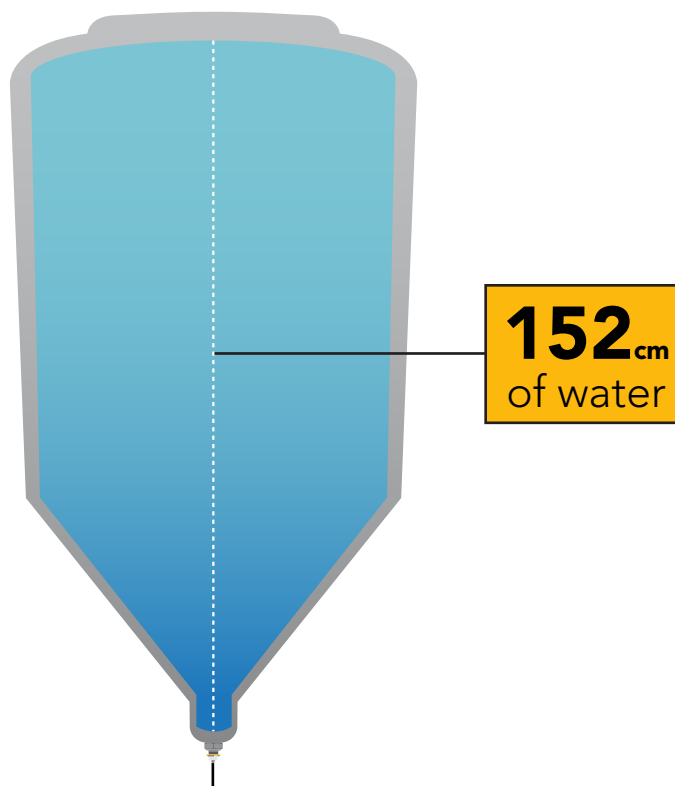
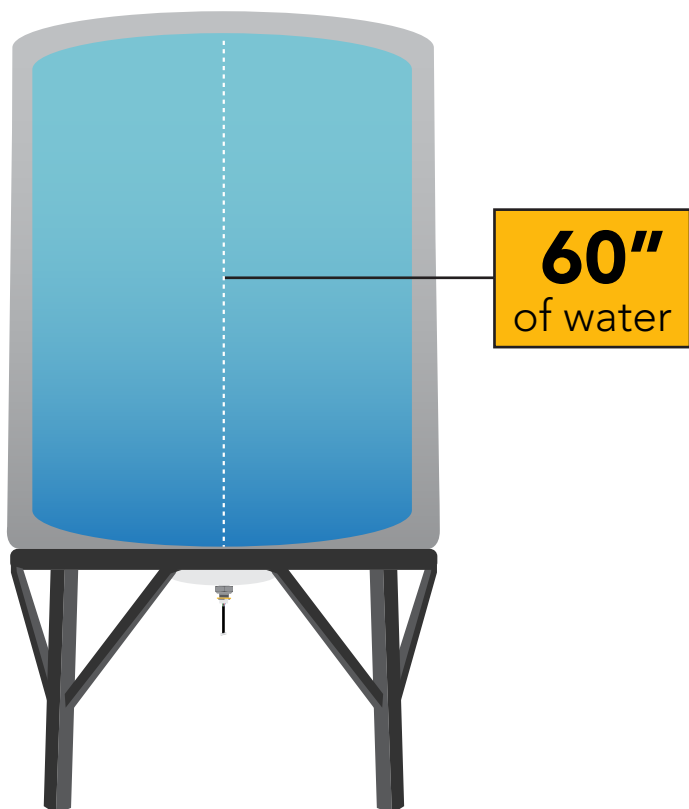

Calibration theory

The Atlas Scientific EZO-PRS™ Embedded Pressure Sensor comes half-calibrated. When using the sensor for the first time, it is common to see a small pressure reading even though it is not connected to a pressure source. Issue the "Cal,0" command to complete the calibration process.

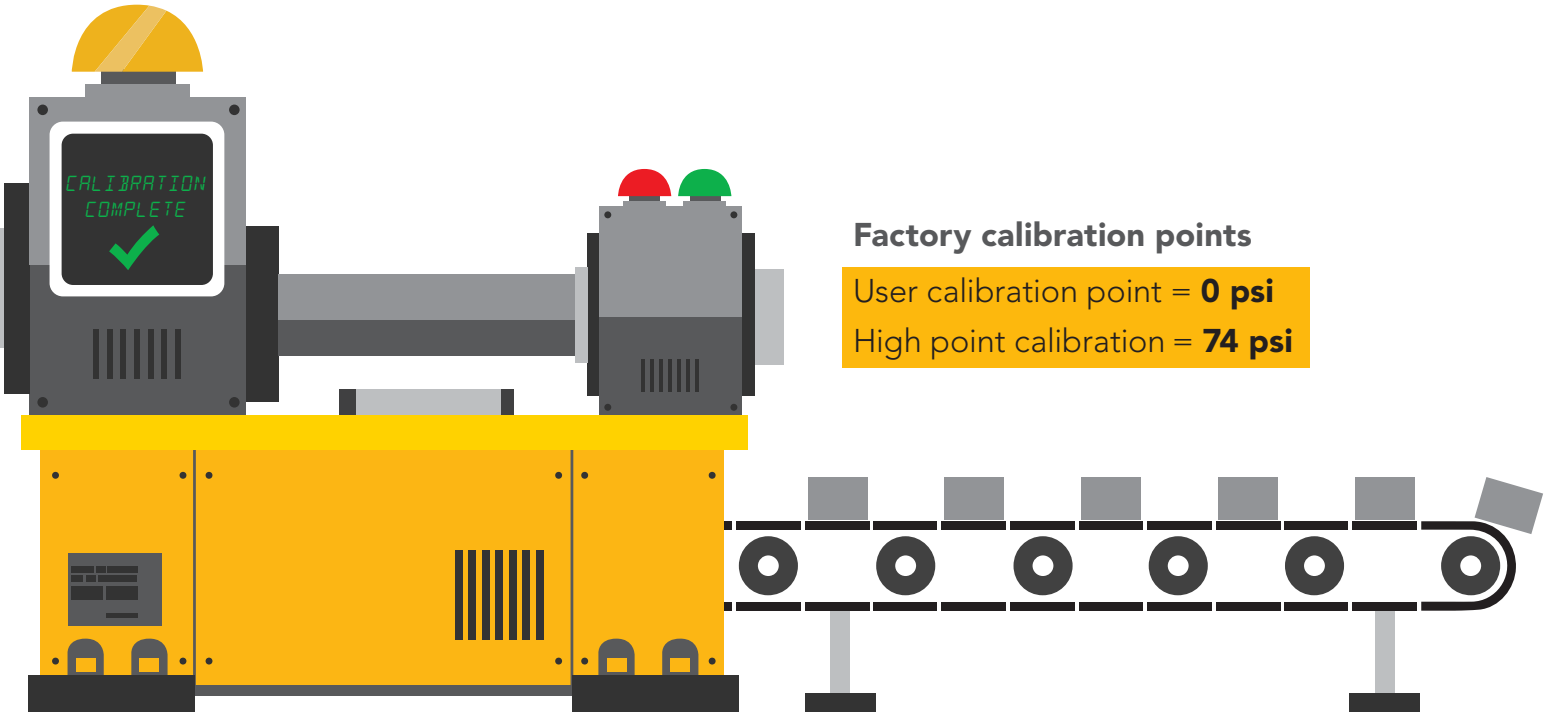

Pin out

Data and power cable pinout

White	-	RX/SCL
Green	-	TX/SDA
Black	-	GND
Red	-	VCC
Blue	-	ALM



The interrupt pin will go high when a set pressure level has been crossed.

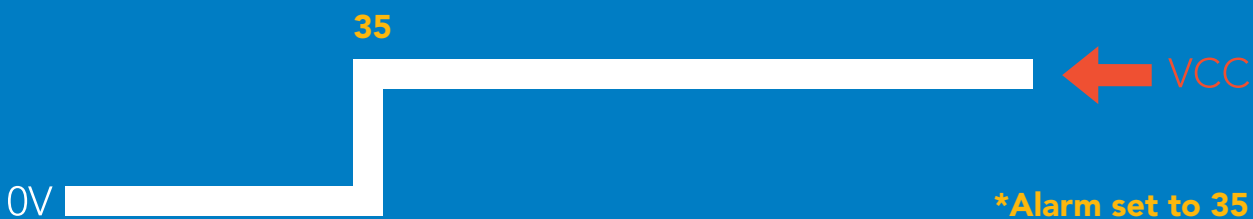

If unused leave **ALM** floating. Do not connect **ALM** to **VCC** or **GND**.

See page **21** or **45** to enable pressure level alarm.

Default state

UART mode

Baud	9,600
Readings	continuous
Units	PSI
Speed	1 reading per second
LED	on

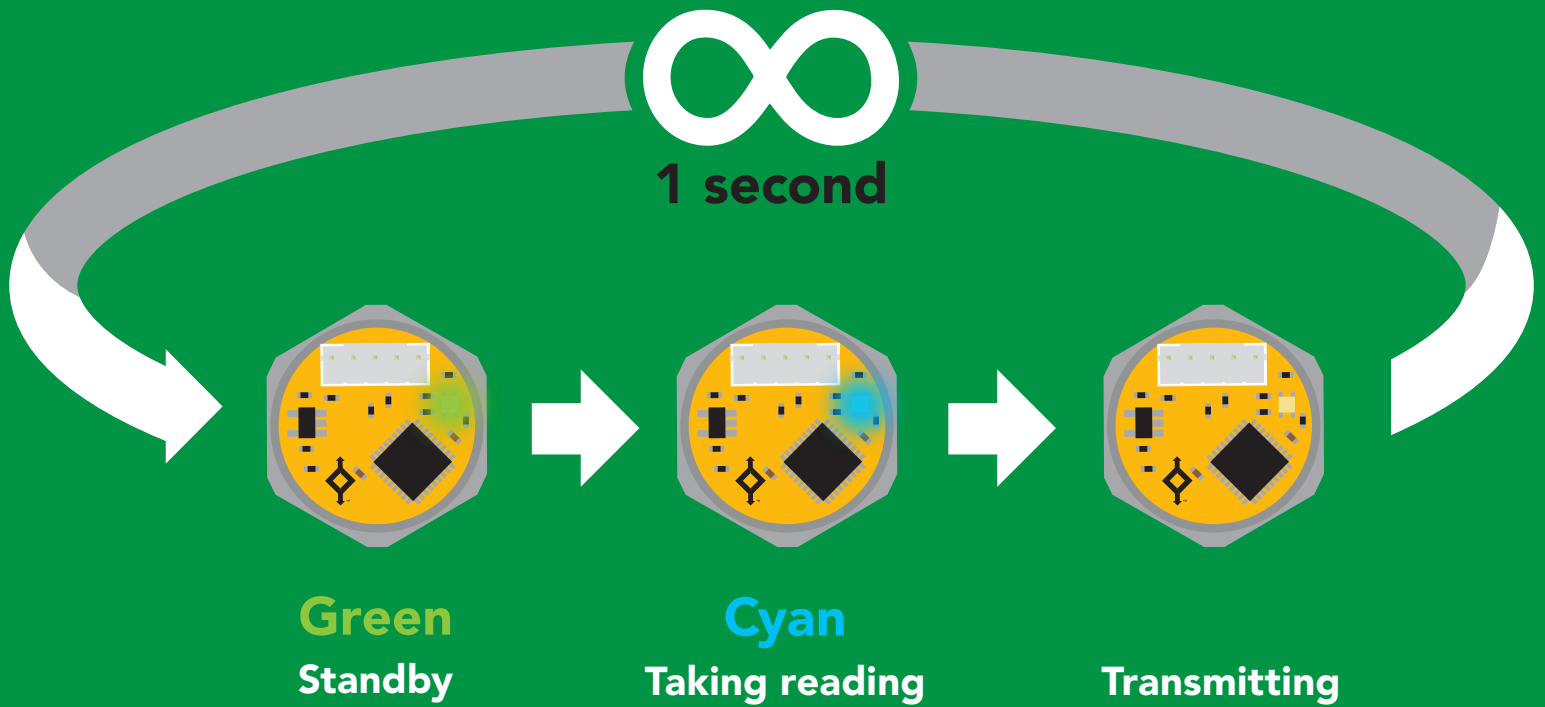

✓ Available data protocols

UART

Default

I²C

✗ Unavailable data protocols

SPI

Analog

RS-485

Mod Bus

4–20mA

UART mode

Settings that are retained if power is cut

- Baud rate
- Calibration
- Continuous mode
- Custom calibration
- Device name
- Enable/disable response codes
- Hardware switch to I²C mode
- LED control
- Protocol lock
- Software switch to I²C mode

Settings that are **NOT** retained if power is cut

- Find
- Sleep mode

UART mode

8 data bits no parity
1 stop bit no flow control

Baud 300
1,200
2,400
9,600 default
19,200
38,400
57,600
115,200



Vcc 3.3V – 5.5V



Data format

Output pressure
Units **PSI default**
 (ATM, kPa, bar,
 inch's of water
 cm of water)
Encoding **ASCII**
Format **string**

Terminator carriage return
Data type floating point
Decimal places 3
Smallest string 3 characters
Largest string 39 characters

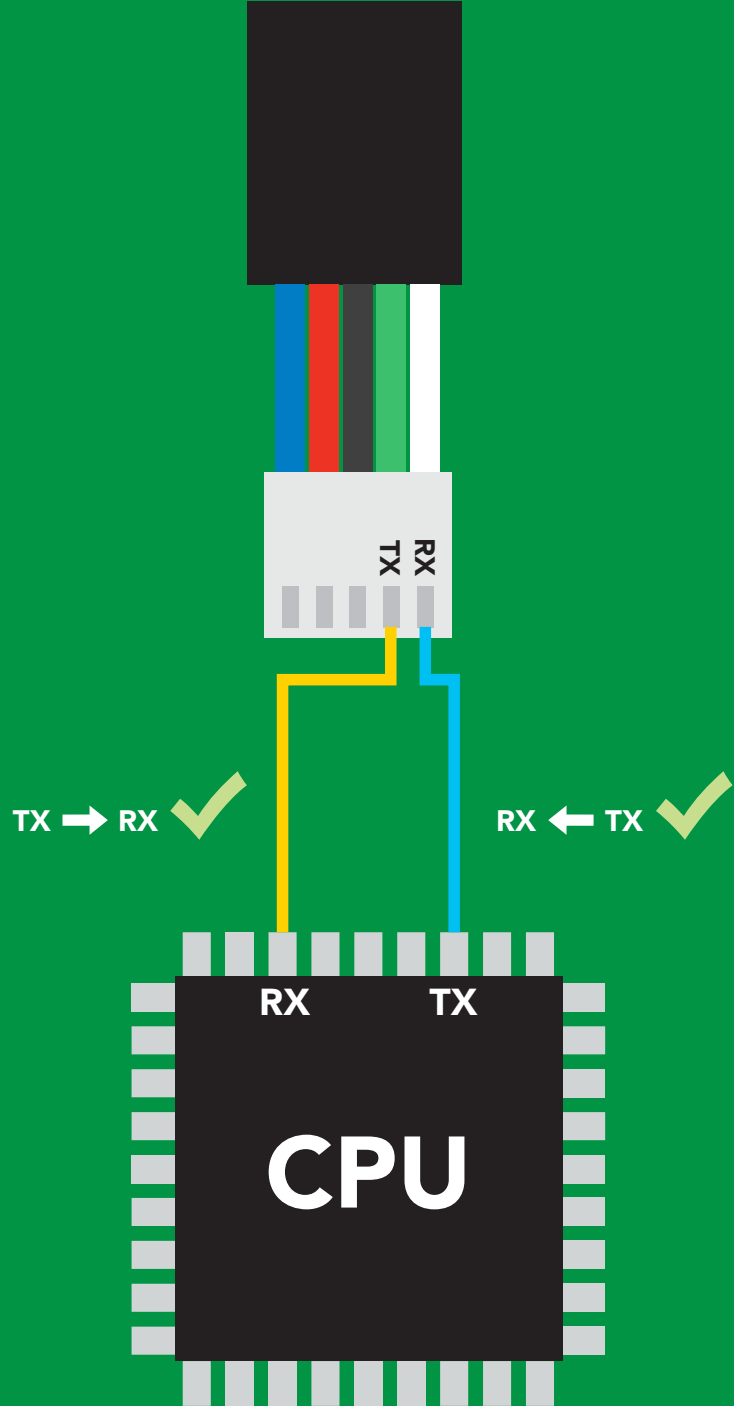

Receiving data from device

2 parts

ASCII data string

Command

Carriage return <cr>

Terminator

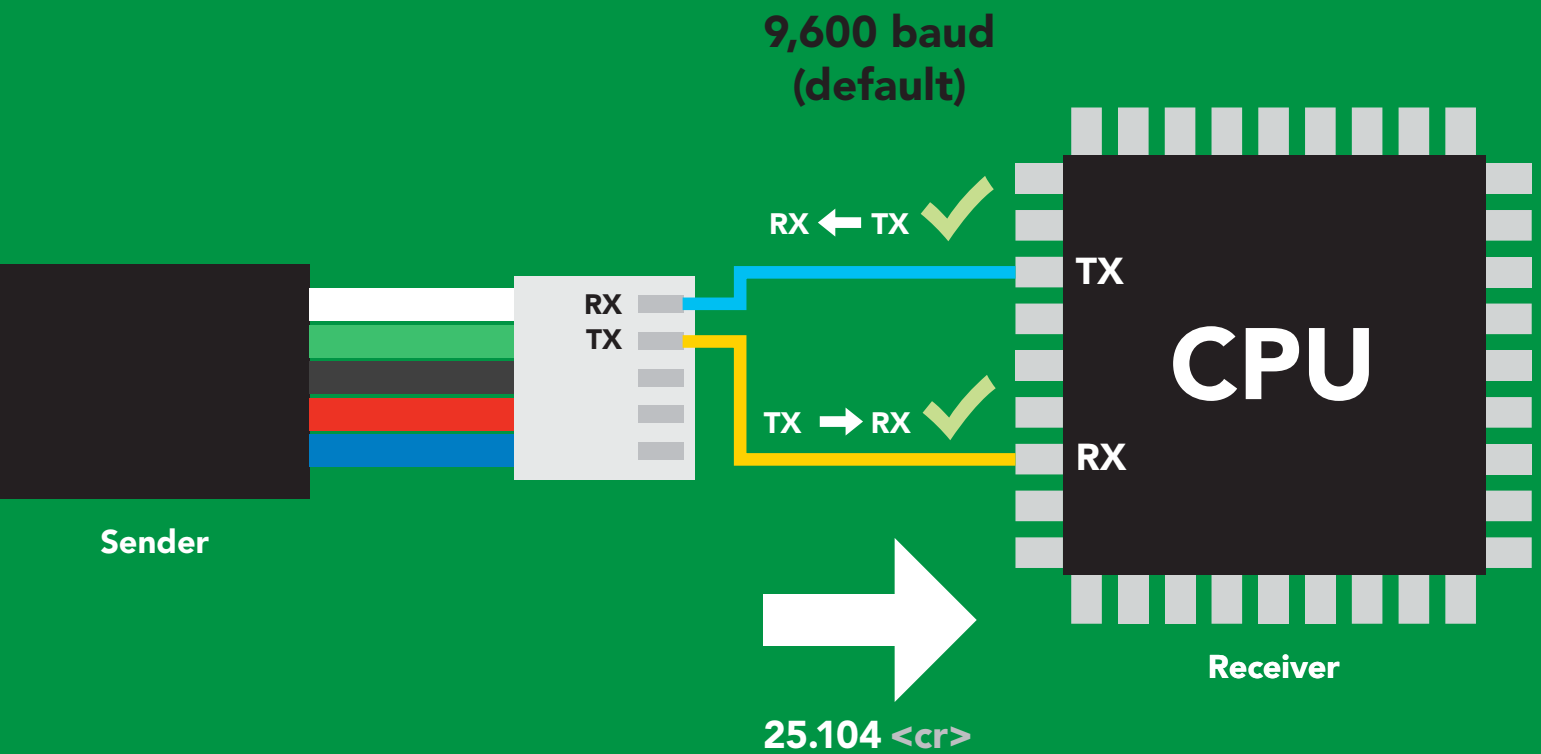

Advanced

ASCII: 2 5 . 1 0 4 <cr>

Hex: 32 35 2E 31 30 34 0D

Dec: 50 53 46 49 48 52 13

Sending commands to device

2 parts

Command (not case sensitive)

ASCII data string

Carriage return <cr>

Terminator

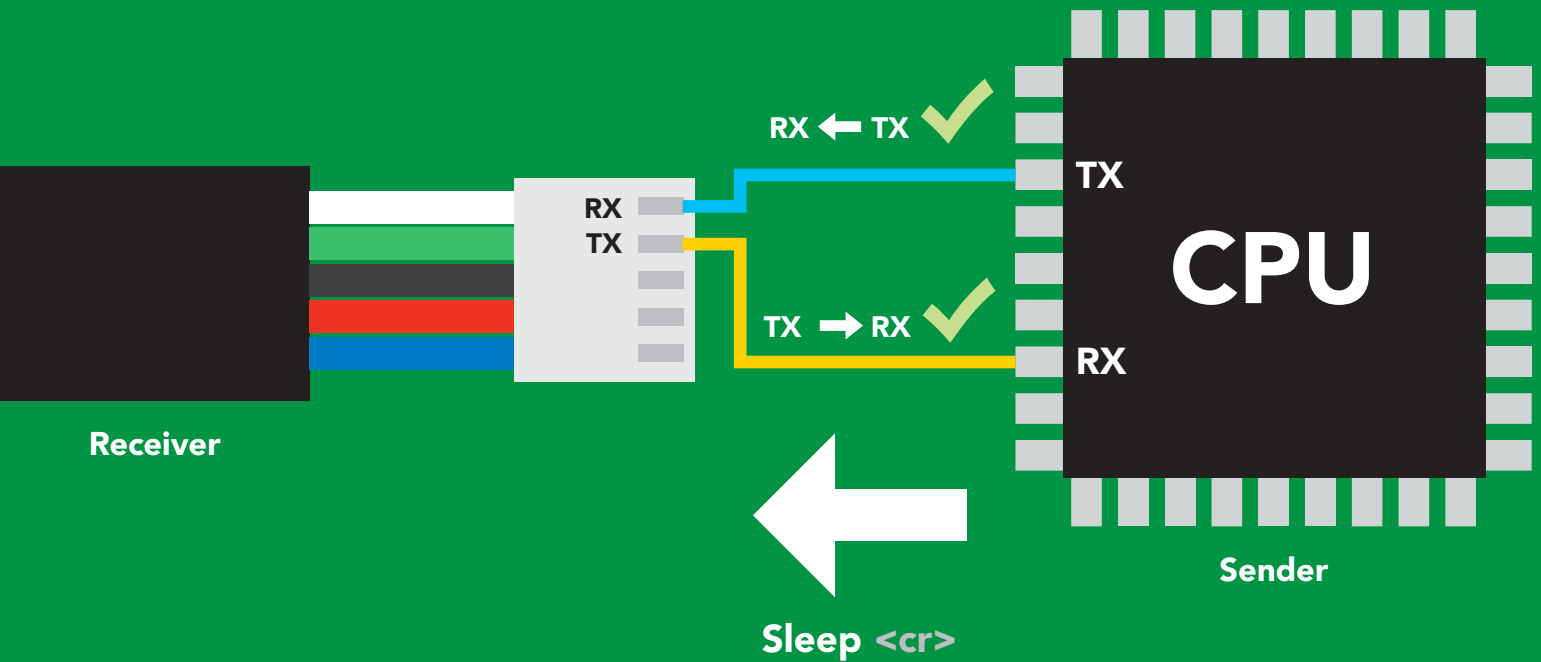

Advanced

ASCII: **S** **I** **e** **e** **p** **<cr>**

Hex: **53** **6C** **65** **65** **70** **0D**

Dec: **83** **108** **101** **101** **112** **13**

LED color definition

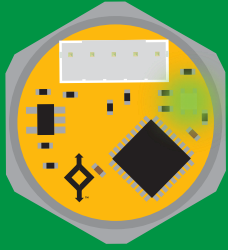

Green

UART standby

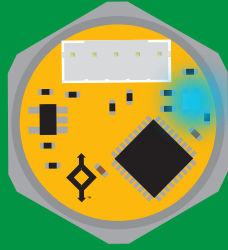

Cyan

Taking reading

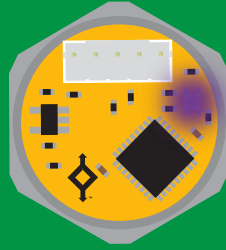

Purple

Changing
baud rate

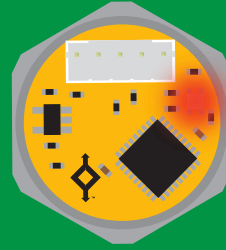

Red

Command
not understood

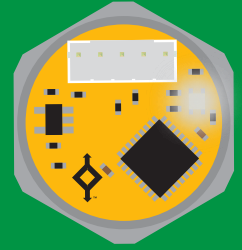

White

Find

5V

LED ON
+0.25 mA

3.3V

+0.26 mA

UART mode

command quick reference

All commands are ASCII strings or single ASCII characters.

Command	Function		Default state
Alarm	enable/disable alarm	pg. 21	n/a
Baud	change baud rate	pg. 30	9,600
C	enable/disable continuous mode	pg. 19	enabled
Cal	performs custom calibration	pg. 22	n/a
Dec	add/remove decimal places	pg. 23	n/a
Factory	enable factory reset	pg. 32	n/a
Find	finds device with blinking white LED	pg. 18	n/a
i	device information	pg. 26	n/a
I2C	change to I ² C mode	pg. 33	not set
L	enable/disable LED	pg. 17	enabled
Name	set/show name of device	pg. 25	not set
Plock	enable/disable protocol lock	pg. 31	disabled
R	returns a single reading	pg. 20	n/a
Sleep	enter sleep mode/low power	pg. 29	n/a
Status	retrieve status information	pg. 28	enable
U	pressure units	pg. 24	psi
*OK	enable/disable response codes	pg. 27	enable

LED control

Command syntax

L,1 <cr> LED on **default**

L,0 <cr> LED off

L,? <cr> LED state on/off?

Example

Response

L,1 <cr>

*OK <cr>

L,0 <cr>

*OK <cr>

L,? <cr>

?L,1 <cr> or ?L,0 <cr>
*OK <cr>

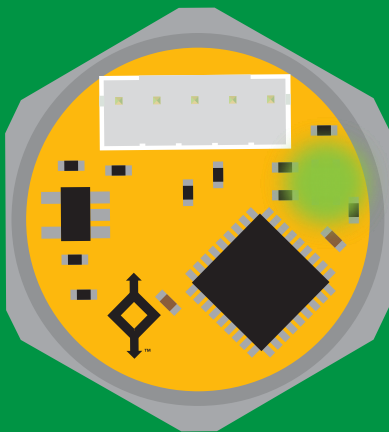

L,1

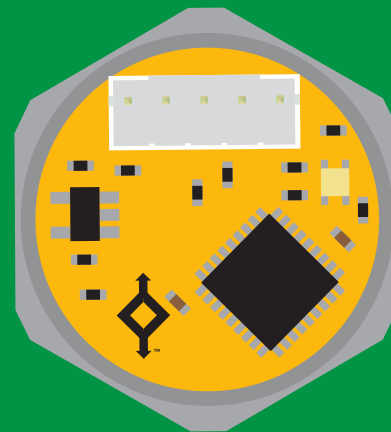

L,0

Find

Command syntax

This command will disable continuous mode
Send any character or command to terminate find.

Find <cr> LED rapidly blinks white, used to help find device

Example

Response

Find <cr>

*OK <cr>

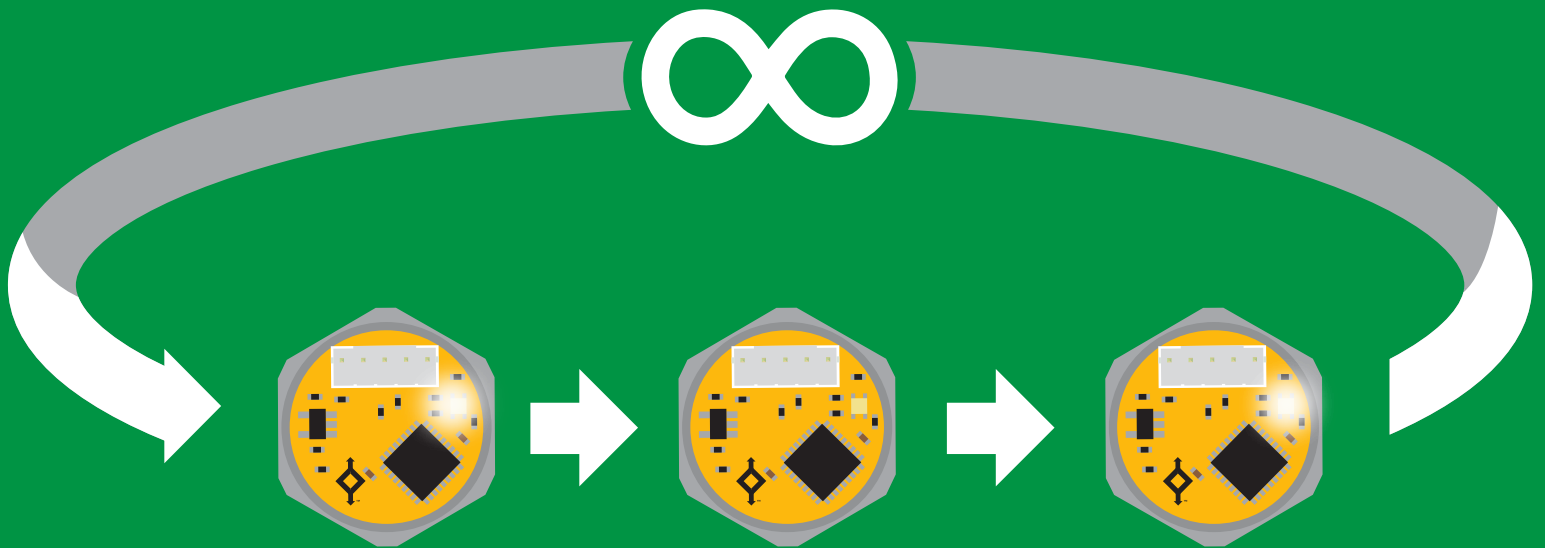

Continuous mode

Command syntax

- C,1 <cr>** enable continuous readings once per second **default**
- C,n <cr>** continuous readings every n seconds (n = 2 to 99 sec)
- C,0 <cr>** disable continuous readings
- C,? <cr>** continuous reading mode on/off?

Example

Response

C,1 <cr>

***OK <cr>**
pressure (1 sec) <cr>
pressure (2 sec) <cr>
pressure (n sec) <cr>

C,30 <cr>

***OK <cr>**
pressure (30 sec) <cr>
pressure (60 sec) <cr>
pressure (90 sec) <cr>

C,0 <cr>

***OK <cr>**

C,? <cr>

?C,1 <cr> or ?C,0 <cr> or ?C,30 <cr>
***OK <cr>**

Single reading mode

Command syntax

R <cr> takes single reading

Example

R <cr>

Response

38.462 <cr>

***OK** <cr>

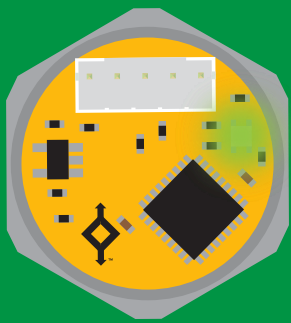

Green
Standby

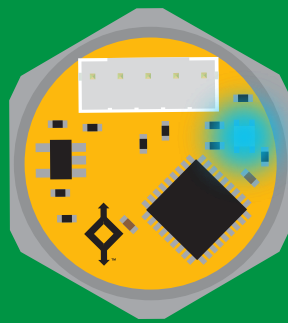

Cyan
Taking reading

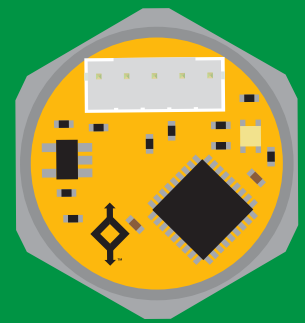

Transmitting



1 second

Alarm

Command syntax

The alarm pin will = 1 when pressure levels are > alarm set point. Alarm tolerance sets how far below the set point pressure levels need to drop before the pin will = 0 again.

Alarm,en,[1,0] <cr> **enable / disable alarm**

Alarm,n <cr> **sets alarm**

Alarm,tol,n <cr> **sets alarm tolerance**

Alarm,? <cr> **alarm set?**

Example

Response

Alarm,en,1 <cr>

***OK** <cr> **Enable alarm**

Alarm,35 <cr>

***OK** <cr>

Alarm,tol,10 <cr>

***OK** <cr> **Pressure level must fall 10 units below set point for alarm to reset.**

Alarm,? <cr>

?,alarm,35,10,1 <cr> **if all are enabled**

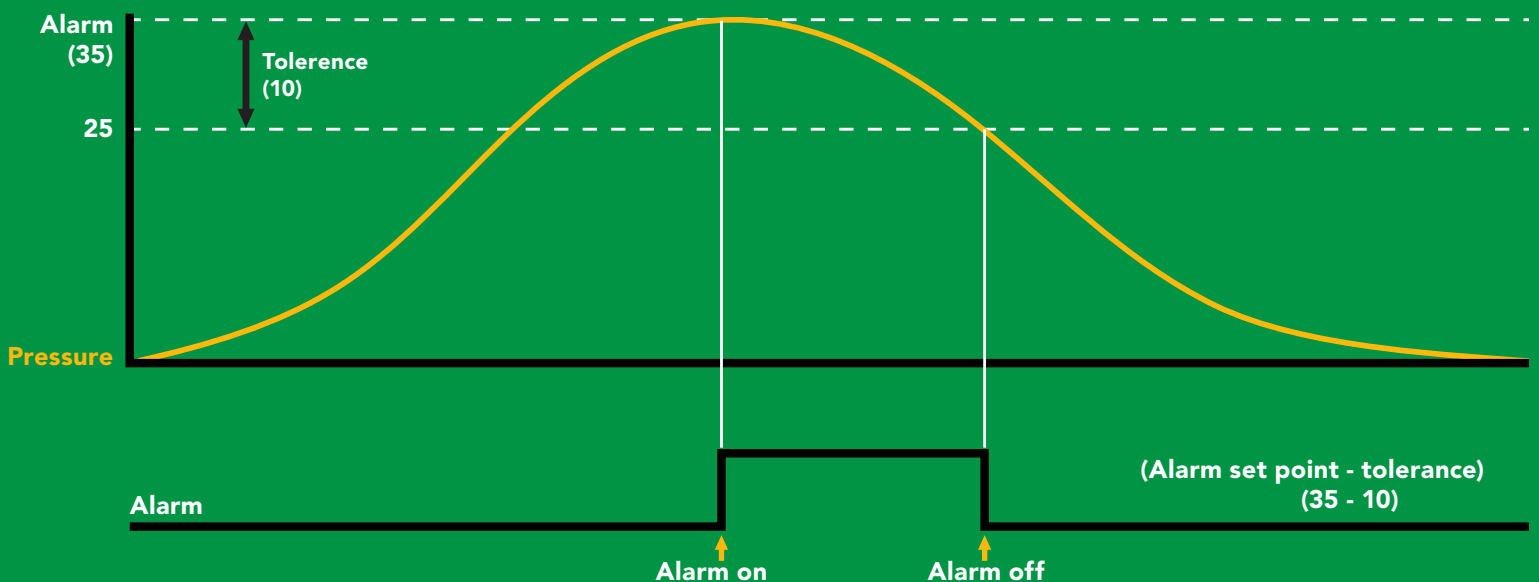

Custom calibration

Command syntax

Although calibration is not required, it may be necessary to adjust your 0 point or perform a custom calibration.

Cal,n	<cr>	calibrates the high point
Cal,0	<cr>	calibrates the zero point
Cal,clear	<cr>	restores calibration to factory settings
Cal,?	<cr>	device calibrated?

Example

Response

Cal,50 <cr>

*OK <cr> high point calibration in psi

Cal,0 <cr>

*OK <cr> low point calibration in psi

Cal,clear <cr>

*OK <cr>

Cal,? <cr>

?Cal,0 <cr> or ?Cal,1 <cr> or ?Cal,2 <cr> or
no calibration only zero point calibration only high point calibration

?Cal,3 <cr> *OK <cr>
zero and high point calibration

Calibration should be done using the pressure scale you have set the sensor to.

Example

Readings are set to bar.
High point calibration = 3.44
(3.44 bar = 50 psi)

Add/remove decimal places

Command syntax

Change how many decimal points the reading outputs.

Dec,n <cr> n = number of decimal points between 0 and 3
Dec,? <cr> number of decimal points the output is set to

Example

Response

R <cr>

38.462 <cr>

Dec,1 <cr>

***OK <cr>**

R <cr>

38.4 <cr>

Dec,? <cr>

?Dec,1 <cr>

Pressure units

(psi, atm, bar, kPa, inch's of water, cm of water)

Command syntax

U,[1/0]	<cr>	1 will add a unit identifier to the output	
U,psi	<cr>	output will be in psi	default
U,atm	<cr>	output will be in atm	
U,bar	<cr>	output will be in bar	
U,kPa	<cr>	output will be in kPa	
U,inh2o	<cr>	output will be in inches of water	(Resolution: 0.027")
U,cmh2o	<cr>	output will be in cm of water	(Resolution: 0.7mm)
U,?	<cr>	pressure units?	

Example

Response

U,bar <cr>

*OK <cr>

U,1 <cr>

*OK <cr>

1.228,bar <cr>

U,? <cr>

?U,bar <cr>

Naming device

Command syntax

Do not use spaces in the name

Name,n <cr> set name

Name, <cr> clears name

Name,? <cr> show name

n =

1 2 3 4 5 6 7 8 9 10 11 12 13 14 15 16

Up to 16 ASCII characters

Example

Response

Name, <cr>

*OK <cr> name has been cleared

Name,zzt <cr>

*OK <cr>

Name,? <cr>

?Name,zzt <cr>
*OK <cr>

Name,zzt

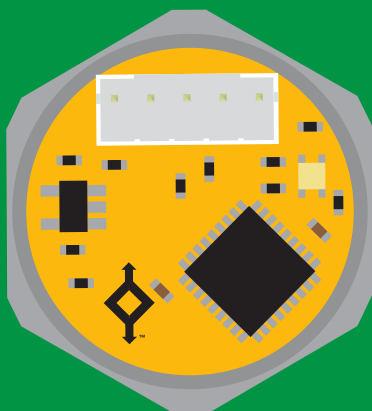

*OK <cr>



Name,?

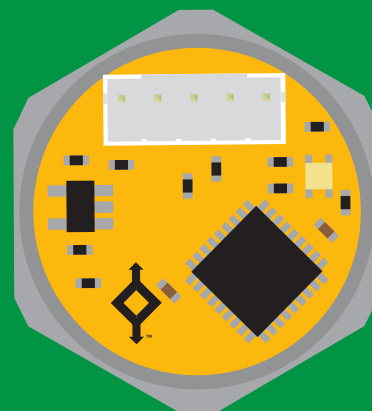

?Name,zzt <cr>
*OK <cr>

Device information

Command syntax

```
i <cr> device information
```

Example

```
i <cr>
```

Response

```
?i,PRS,1.0 <cr>  
*OK <cr>
```

Response breakdown

?i,	PRS	1.0
	↑	↑
	Device	Firmware

Response codes

Command syntax

- *OK,1** <cr> enable response **default**
- *OK,0** <cr> disable response
- *OK,?** <cr> response on/off?

Example

Response

R <cr>

38.462 <cr>
***OK** <cr>

***OK,0** <cr>

no response, ***OK** disabled

R <cr>

38.462 <cr> ***OK** disabled

***OK,?** <cr>

?*OK,1 <cr> or **?*OK,0** <cr>

Other response codes

- *ER** unknown command
- *OV** over volt ($VCC \geq 5.5V$)
- *UV** under volt ($VCC \leq 3.1V$)
- *RS** reset
- *RE** boot up complete, ready
- *SL** entering sleep mode
- *WA** wake up

These response codes cannot be disabled

Reading device status

Command syntax

Status <cr> voltage at Vcc pin and reason for last restart

Example

```
Status <cr>
```

Response

```
?Status,P,5.038 <cr>  
*OK <cr>
```

Response breakdown

?Status,	P,	5.038
	↑	↑
	Reason for restart	Voltage at Vcc

Restart codes

P	powered off
S	software reset
B	brown out
W	watchdog
U	unknown

Sleep mode/low power

Command syntax

Send any character or command to awaken device.

`Sleep <cr>` enter sleep mode/low power

Example

Response

`Sleep <cr>`

`*OK <cr>`

`*SL <cr>`

Any command

`*WA <cr>` wakes up device

5V

STANDBY	SLEEP
13.4 mA	0.415 mA

3.3V

12.4 mA	0.13 mA
---------	---------

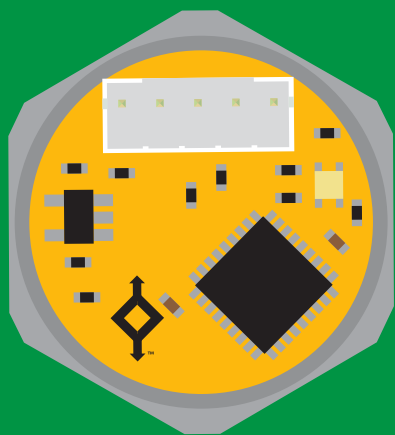

Standby
13.4 mA

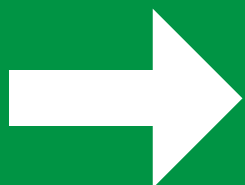

`Sleep <cr>`

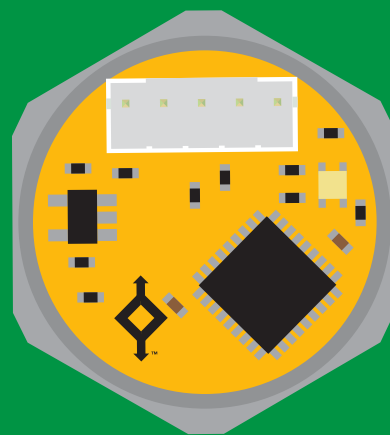

Sleep
0.415 mA

Change baud rate

Command syntax

Baud,n <cr> change baud rate

Example

Baud,38400 <cr>

Response

*OK <cr>

Baud,? <cr>

?Baud,38400 <cr>

*OK <cr>

n =

- 300
- 1200
- 2400
- 9600 default**
- 19200
- 38400
- 57600
- 115200

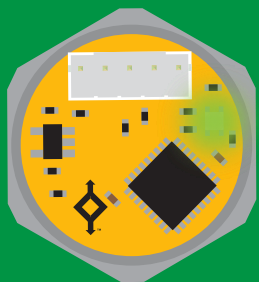

Standby

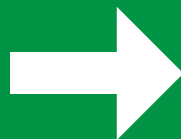

Baud,38400 <cr>

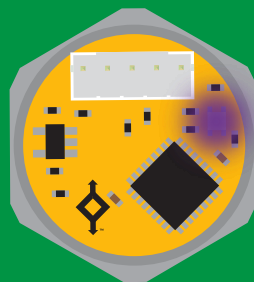

Changing
baud rate

*OK <cr>

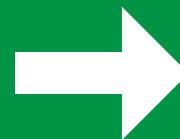

(reboot)

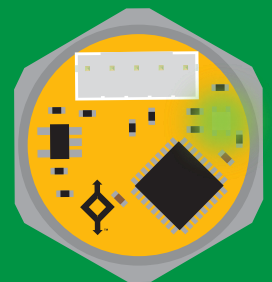

Standby

Protocol lock

Command syntax

Locks device to UART mode.

Plock,1 <cr> enable Plock

Plock,0 <cr> disable Plock **default**

Plock,? <cr> Plock on/off?

Example

Response

Plock,1 <cr>

***OK** <cr>

Plock,0 <cr>

***OK** <cr>

Plock,? <cr>

?Plock,1 <cr> **or** **?Plock,0** <cr>

Plock,1

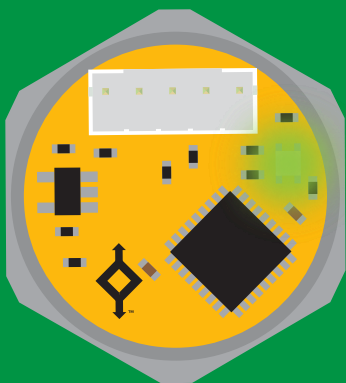

***OK** <cr>

I2C,100

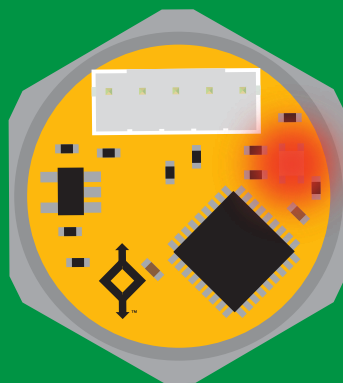

cannot change to I²C

***ER** <cr>

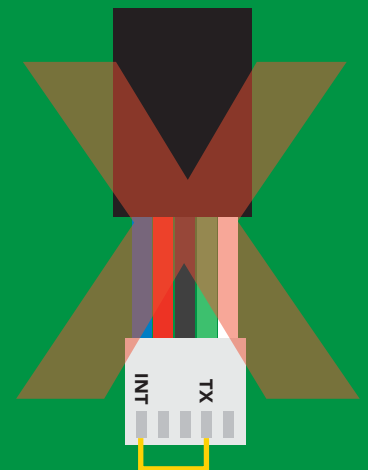

cannot change to I²C

Factory reset

Command syntax

Clears calibration
LED on
"*OK" enabled

Factory <cr> enable factory reset

Example

Response

Factory <cr>

*OK <cr>

Factory <cr>

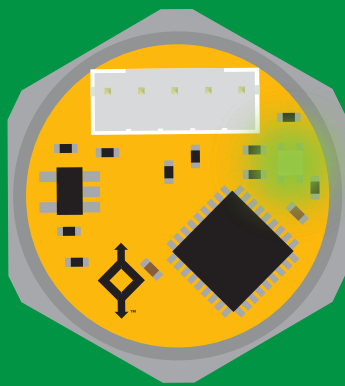

*OK <cr>



(reboot)

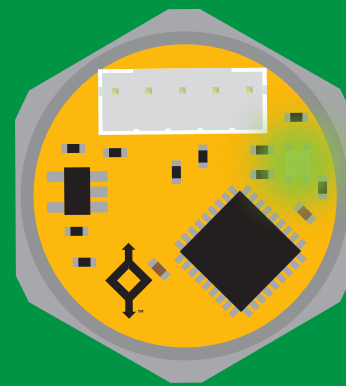

*RS <cr>
*RE <cr>

Baud rate will not change

Change to I²C mode

Command syntax

Default I²C address 106 (0x6A)

I2C,n <cr> sets I²C address and reboots into I²C mode

n = any number 1 – 127

Example

Response

I2C,100 <cr>

*OK (reboot in I²C mode)

Wrong example

Response

I2C,139 <cr> n ≠ 127

*ER <cr>

I2C,100

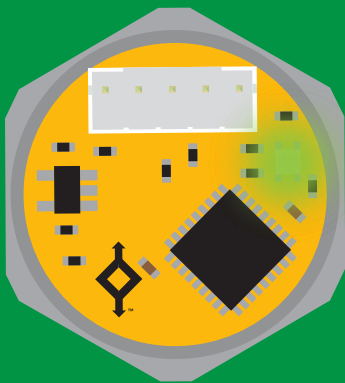

Green
*OK <cr>

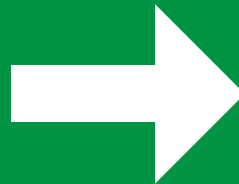

(reboot)

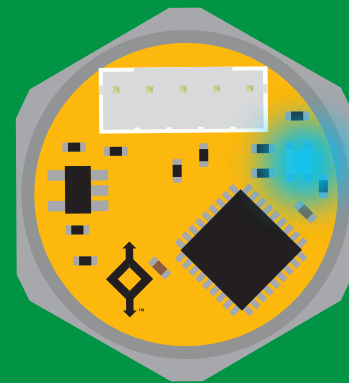

Blue
now in I²C mode

Manual switching to I²C

- Disconnect ground (power off)
- Disconnect TX and RX
- Connect TX to INT
- Confirm RX is disconnected
- Connect ground (power on)
- Wait for LED to change from **Green to Blue**
- Disconnect ground (power off)
- Reconnect all data and power

Manually switching to I²C will set the I²C address to 106 (0x6A)

Example

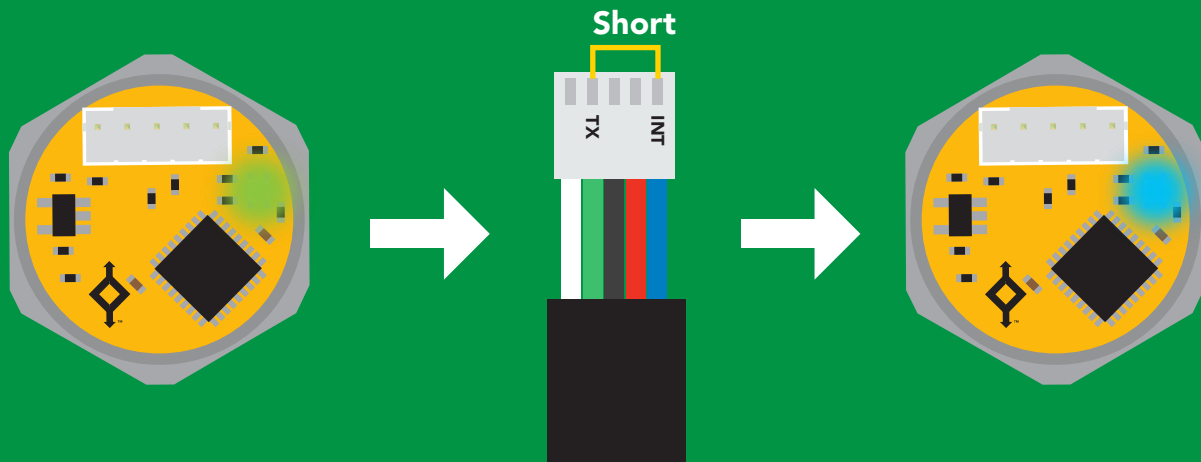

Wrong Example

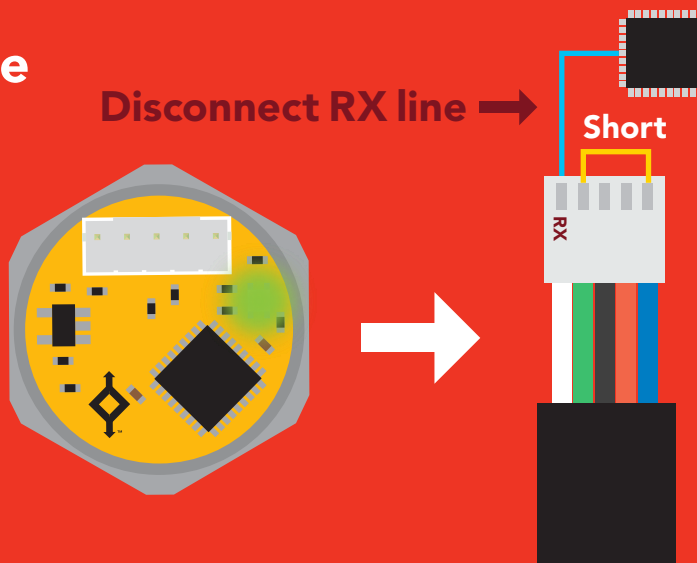

I²C mode

The I²C protocol is **considerably more complex** than the UART (RS-232) protocol. Atlas Scientific assumes the embedded systems engineer understands this protocol.

To set your EZO-PRS™ into I²C mode click [here](#)

Settings that are retained if power is cut

- Calibration
- Change I²C address
- Custom calibration
- Hardware switch to UART mode
- LED control
- Protocol lock
- Software switch to UART mode

Settings that are **NOT** retained if power is cut

- Find
- Sleep mode

I²C mode

I²C address (0x01 – 0x7F)
106 (0x6A) default

Vcc 3.3V – 5.5V

Clock speed 100 – 400 kHz

SDA 

SCL 

0V VCC 0V

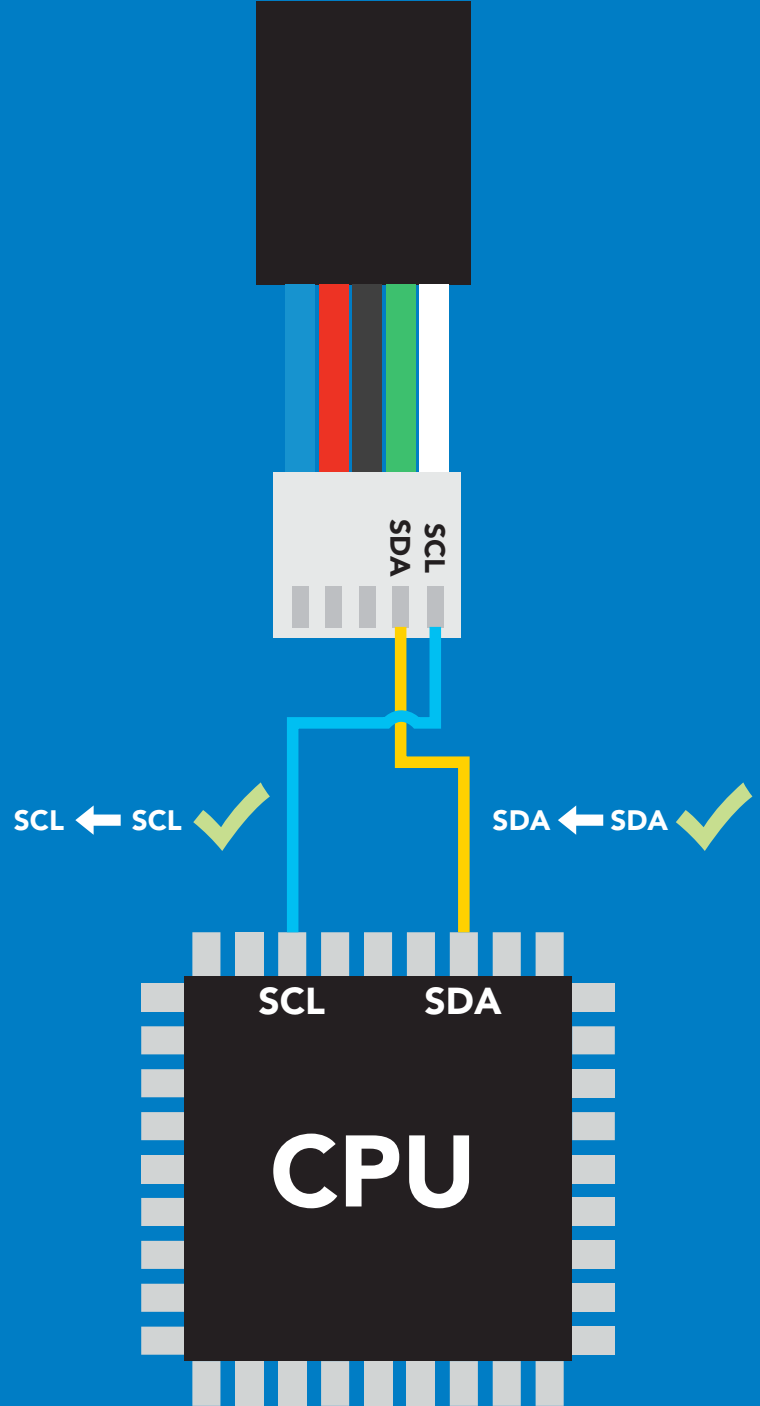

Data format

Output pressure
Units **PSI default**
(ATM, kPa, bar,
inch's of water
cm of water)

Encoding **ASCII**
Format **string**

Data type **floating point**
Decimal places **3**
Smallest string **3 characters**
Largest string **39 characters**

Sending commands to device

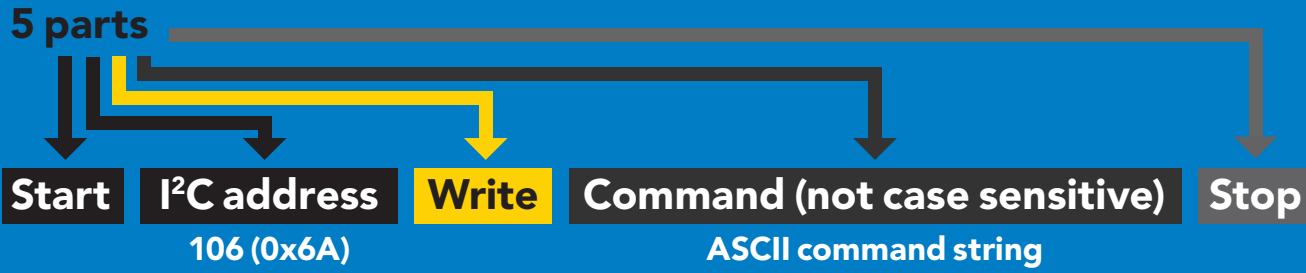

Example

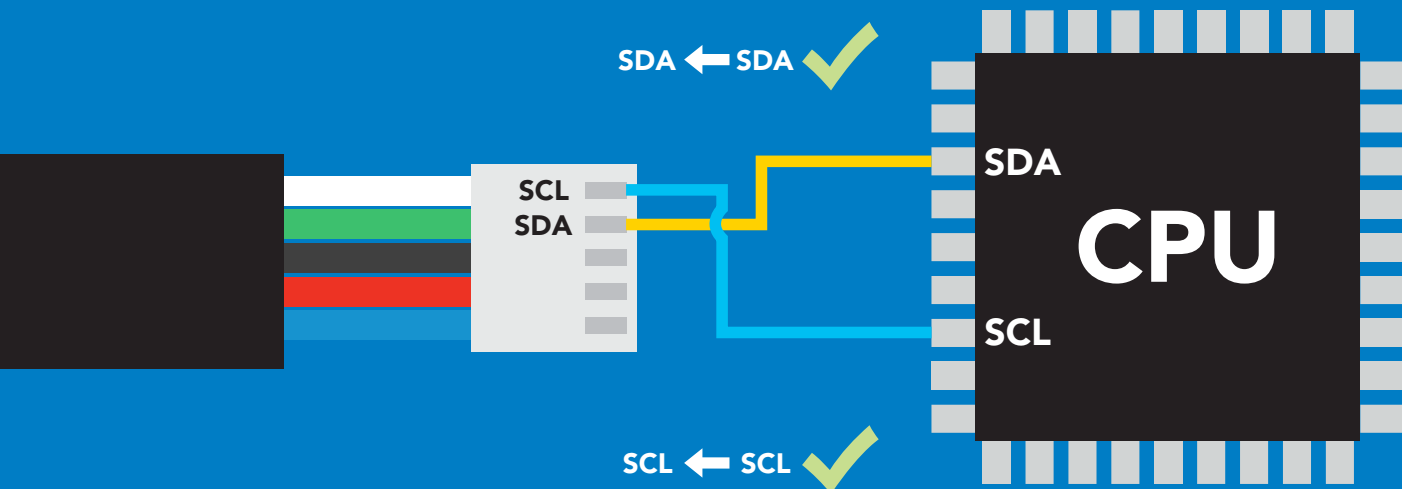

Advanced

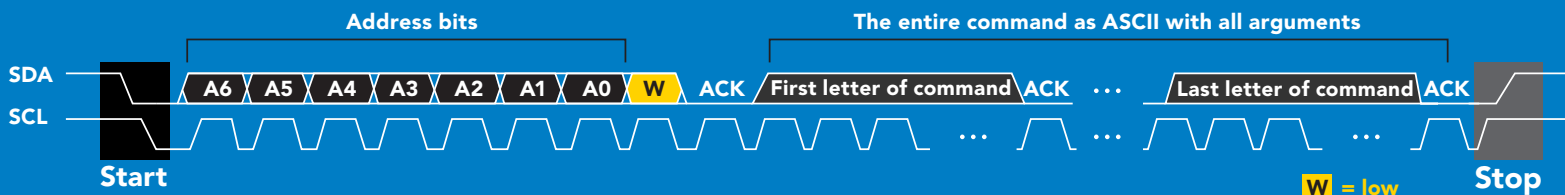

Response codes

After a command has been issued, a 1 byte response code can be read in order to confirm that the command was processed successfully.

Reading back the response code is completely optional, and is not required for normal operation.

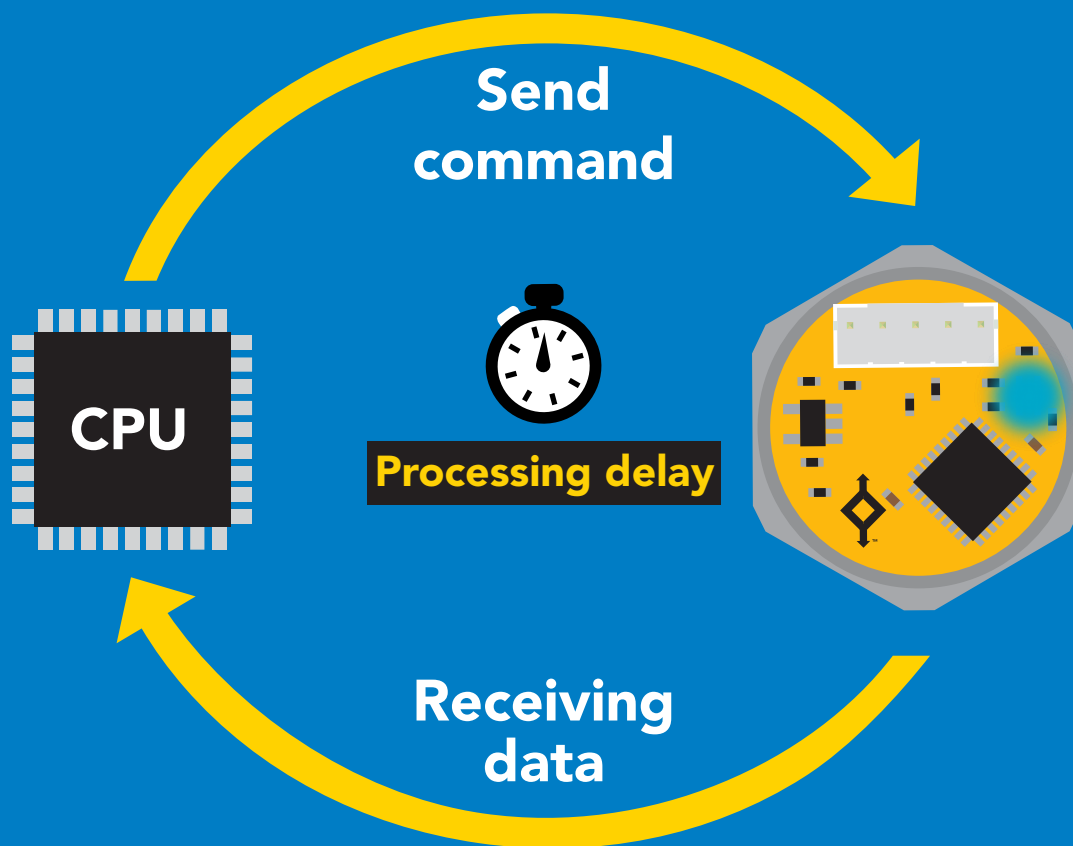

Example

```
I2C_start;  
I2C_address;  
I2C_write(EZO_command);  
I2C_stop;
```

```
delay(300);
```



```
Processing delay
```

```
I2C_start;  
I2C_address;  
Char[ ] = I2C_read;  
I2C_stop;
```

If there is no processing delay or the processing delay is too short, the response code will always be 254.

Response codes

Single byte, not string

255	no data to send
254	still processing, not ready
2	syntax error
1	successful request

LED color definition

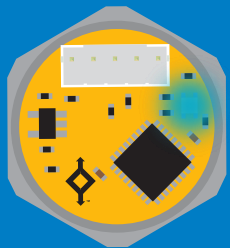

Blue

I²C standby

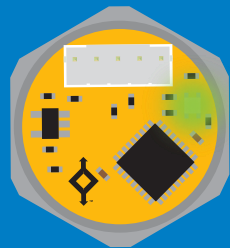

Green

Taking reading

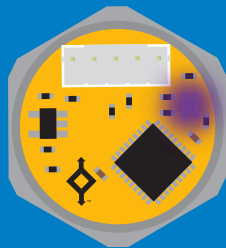

Purple

Changing
I²C address

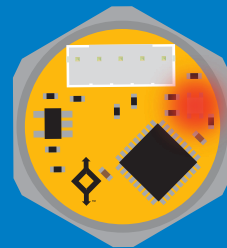

Red

Command
not understood

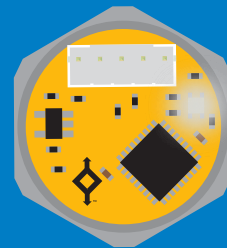

White

Find

5V

LED ON
+0.25 mA

3.3V

+0.26 mA

I²C mode

command quick reference

All commands are ASCII strings or single ASCII characters.

Command	Function	
Alarm	enable/disable alarm	pg. 45
Baud	switch back to UART mode	pg. 56
Cal	performs custom calibration	pg. 46
Dec	add/remove decimal places	pg. 47
Factory	enable factory reset	pg. 55
Find	finds device with blinking white LED	pg. 43
i	device information	pg. 50
I2C	change I ² C address	pg. 54
L	enable/disable LED	pg. 42
Name	set/show name of device	pg. 49
Plock	enable/disable protocol lock	pg. 53
R	returns a single reading	pg. 44
Sleep	enter sleep mode/low power	pg. 52
Status	retrieve status information	pg. 51
U	pressure units	pg. 48

LED control

Command syntax

300ms  processing delay

- L,1 LED on **default**
- L,0 LED off
- L,? LED state on/off?

Example

Response

L,1

 **Wait 300ms** **1** **0**
Dec Null

L,0

 **Wait 300ms** **1** **0**
Dec Null

L,?

 **Wait 300ms** **1** **?L,1** **0** or  **Wait 300ms** **1** **?L,0** **0**
Dec ASCII Null Dec ASCII Null

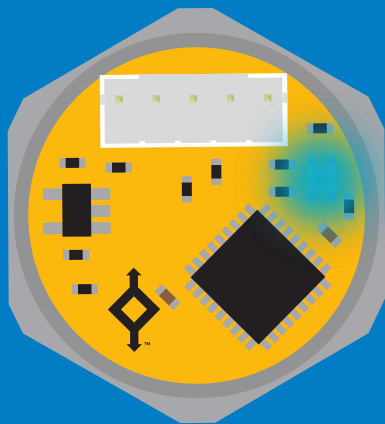

L,1

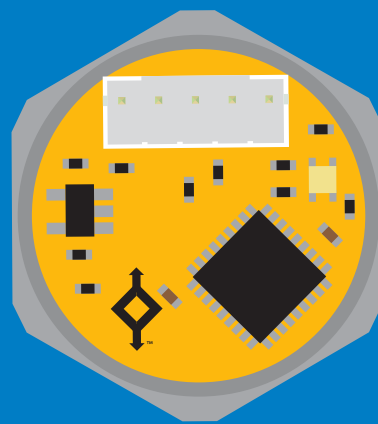

L,0

Find

300ms  processing delay

Command syntax

This command will disable continuous mode.
Send any character or command to terminate find.

Find LED rapidly blinks white, used to help find device

Example

Response

Find

 **Wait 300ms** **1** Dec **0** Null

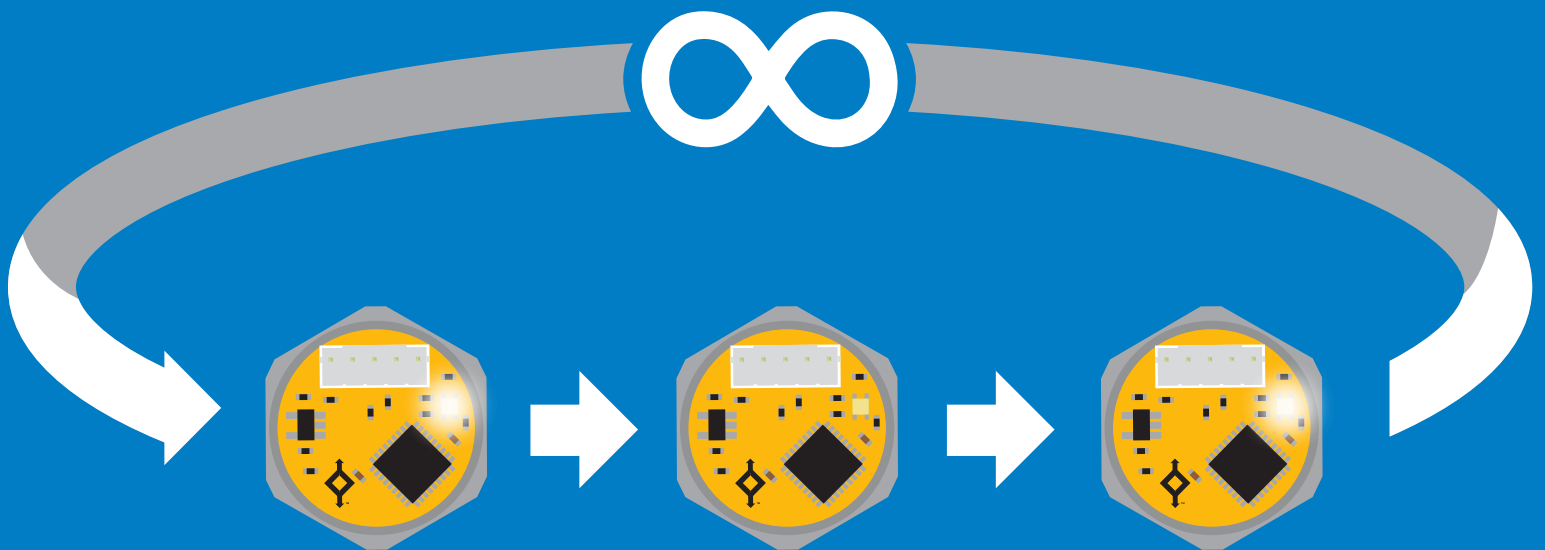

Taking reading

Command syntax

900ms  processing delay

R return 1 reading

Example

Response

R

 Wait 900ms **1** **38.462** **0**
Dec ASCII Null

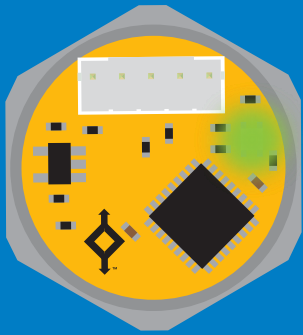

Green
Taking reading

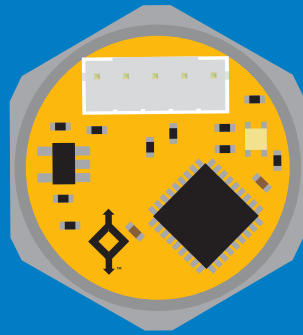
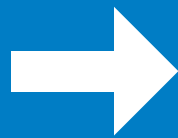

Transmitting

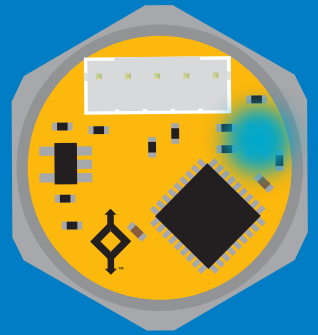
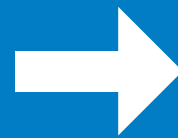

Cyan
Standby

Alarm

300ms  processing delay

Command syntax

The alarm pin will = 1 when pressure levels are > alarm set point. Alarm tolerance sets how far below the set point pressure levels need to drop before the pin will = 0 again.

- Alarm,en,[1,0] enable / disable alarm
- Alarm,n sets alarm
- Alarm,tol,n sets alarm tolerance
- Alarm,? alarm set?

Example

Response

Alarm,en,1

 Wait 300ms **1** **0** Enable alarm
Dec Null

Alarm,35

 Wait 300ms **1** **0**
Dec Null

Alarm,tol,10

 Wait 300ms **1** **0** Pressure level must fall 10 units below set point for alarm to reset.
Dec Null

Alarm,?

 Wait 300ms **1** **?,alarm,35,10,1** **0** if all are enabled
Dec ASCII Null

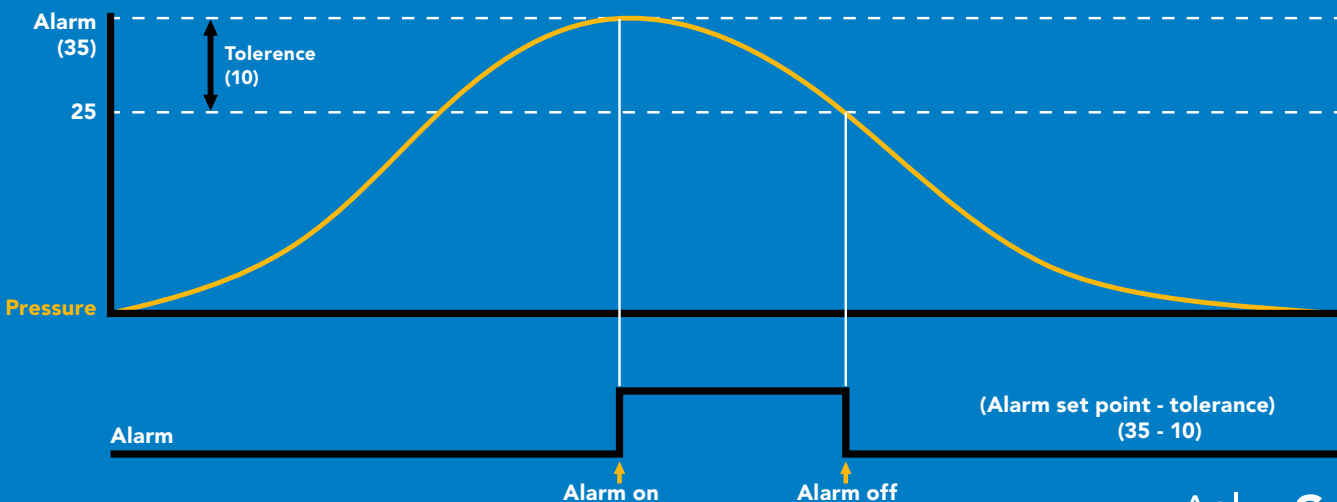

Custom calibration

900ms  processing delay

Command syntax

Although calibration is not required, it may be necessary to adjust your 0 point or perform a custom calibration.

Cal,n	calibrates the high point
Cal,0	calibrates the zero point
Cal,clear	restores calibration to factory settings
Cal,?	device calibrated?

Example

Response

Cal,50

 **1** **0** high point calibration in psi
Wait 900ms Dec Null

Cal,0

 **1** **0** low point calibration in psi
Wait 900ms Dec Null

Cal,clear

 **1** **0**
Wait 300ms Dec Null

Cal,?

 **1** **?Cal,0** **0** or **1** **?Cal,1** **0**
Wait 300ms Dec ASCII Null
no calibration only zero point calibration

or **1** **?Cal,2** **0** or **1** **?Cal,3** **0**
Dec ASCII Null
only high point calibration zero and high point calibration

Calibration should be done using the pressure scale you have set the sensor to.

Example

Readings are set to bar.
High point calibration = 3.44
(3.44 bar = 50 psi)

Add/remove decimal places

900ms  processing delay

Command syntax





Change how many decimal points the reading outputs.

Dec,n n = number of decimal points between 0 and 3

Dec,? number of decimal points the output is set to

Example

Response

R	 Wait 900ms	1	38.462	0
		Dec	ASCII	Null
Dec,1	 Wait 900ms	1	0	
		Dec	Null	
R	 Wait 900ms	1	38.4	0
		Dec	ASCII	Null
Dec,?	 Wait 900ms	1	?Dec,1	0
		Dec	ASCII	Null

Pressure units

(psi, atm, bar, kPa, inch's of water, cm of water)

Command syntax

U,[1/0]	1 will add a unit identifier to the output	
U,psi	output will be in psi	
U,atm	output will be in atm	
U,bar	output will be in bar	
U,kPa	output will be in kPa	
U,inh2o	output will be in inches of water	(Resolution: 0.027")
U,cmh2o	output will be in cm of water	(Resolution: 0.7mm)
U,?	pressure units?	

Example

Response

U,bar

Wait 300ms

1	0
Dec	Null

U,1



Wait 300ms

1	0
Dec	Null

Wait 300ms

1	1.228,bar	0
Dec	ASCII	Null

U,?

Wait 300ms

1	?U,bar	0
Dec	ASCII	Null

Naming device

300ms  processing delay

Command syntax

Do not use spaces in the name

Name,n	set name	n =	1	2	3	4	5	6	7	8	9	10	11	12	13	14	15	16
Name,	clears name																	
Name,?	show name																	

Up to 16 ASCII characters

Example

Response

Name,



1 0
Dec Null

name has been cleared

Name,zzt



1 0
Dec Null

Name,?



1 ?Name,zzt 0
Dec ASCII Null

Name,zzt

Name,?

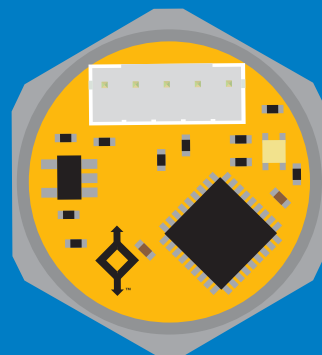
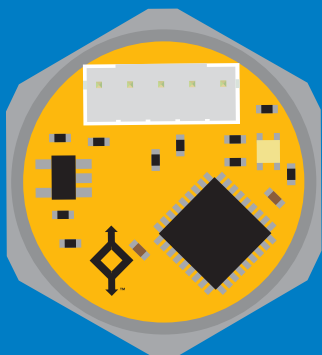

1 0

1 ?Name,zzt 0

Device information

Command syntax

300ms  processing delay

i device information

Example

i

Response



Wait 300ms

1

Dec

?i,PRS, 1.0

ASCII

0

Null

Response breakdown

?i, PRS, 1.0
↑ ↑
Device Firmware

Reading device status

Command syntax

300ms  processing delay

Status voltage at Vcc pin and reason for last restart

Example

Response

Status

 **1** **?Status,P,5.038** **0**
Wait 300ms Dec ASCII Null

Response breakdown

?Status, **P,** **5.038**
Reason for restart Voltage at Vcc

Restart codes

P powered off
S software reset
B brown out
W watchdog
U unknown

Sleep mode/low power

Command syntax

Sleep enter sleep mode/low power

Send any character or command to awaken device.

Example

Response

Sleep

no response

Do not read status byte after issuing sleep command.

Any command

wakes up device

5V

STANDBY	SLEEP
13.4 mA	0.415 mA

3.3V

12.4 mA	0.13 mA
----------------	----------------

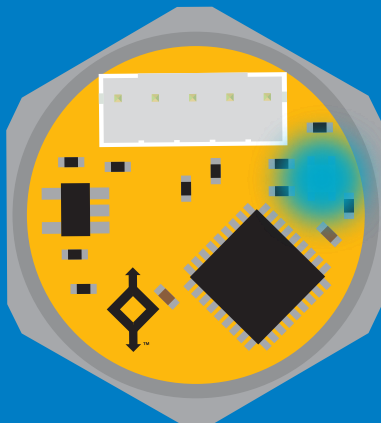

Standby

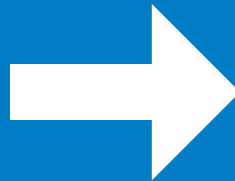

Sleep

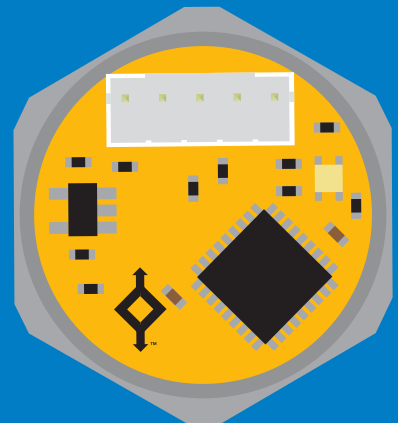

Sleep

Protocol lock

Command syntax

300ms  processing delay

Plock,1 enable Plock

Plock,0 disable Plock

Plock,? Plock on/off?

Locks device to I²C mode.

default

Example

Response

Plock,1

Wait 300ms

1	0
Dec	Null

Plock,0

Wait 300ms

1	0
Dec	Null

Plock,?

Wait 300ms

1	?Plock,1	0
Dec	ASCII	Null

Plock,1

Baud, 9600

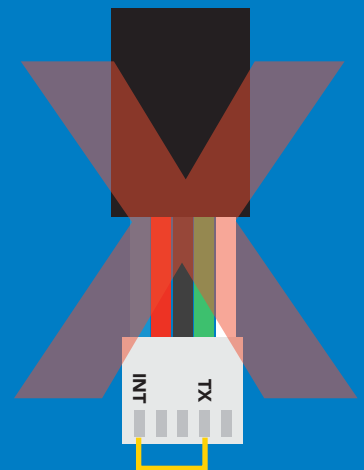
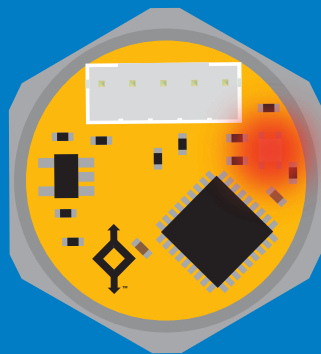
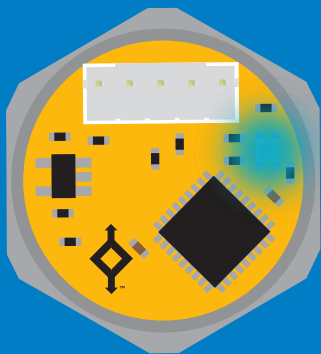

cannot change to UART

cannot change to UART

I²C address change

Command syntax

300ms  processing delay

I2C,n sets I²C address and reboots into I²C mode

Example

Response

I2C,101

device reboot
(no response given)

Warning!

Changing the I²C address will prevent communication between the device and the CPU until the CPU is updated with the new I²C address.

Default I²C address is 106 (0x6A).

n = any number 1 – 127

I2C,101

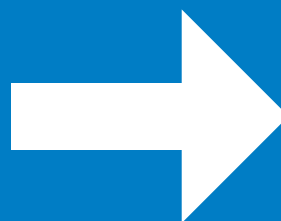
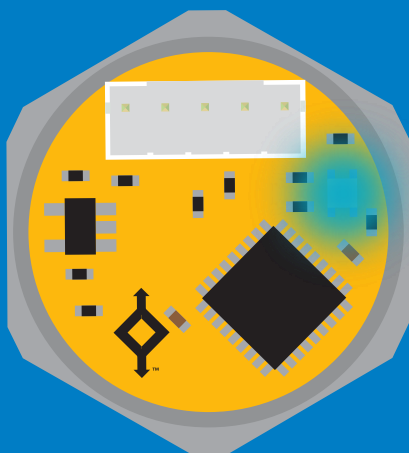

(reboot)

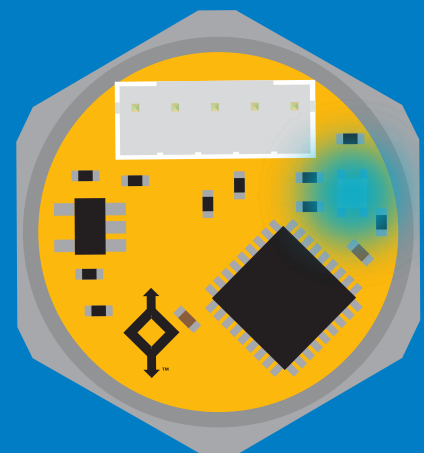

Factory reset

Command syntax

Factory reset will not take the device out of I²C mode.

Factory enable factory reset

I²C address will not change

Example

Response

Factory

device reboot
(no response given)

Clears calibration
LED on
Response codes enabled

Factory

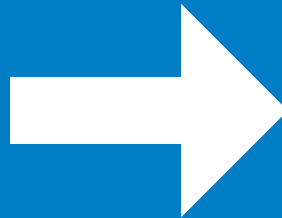
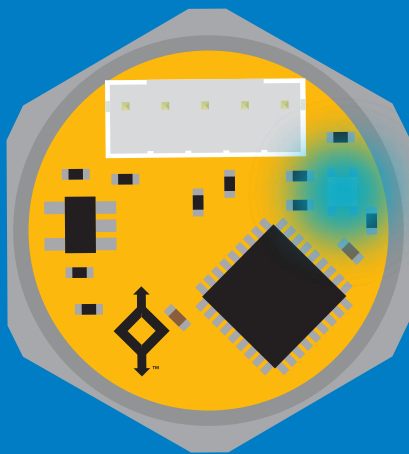

(reboot)

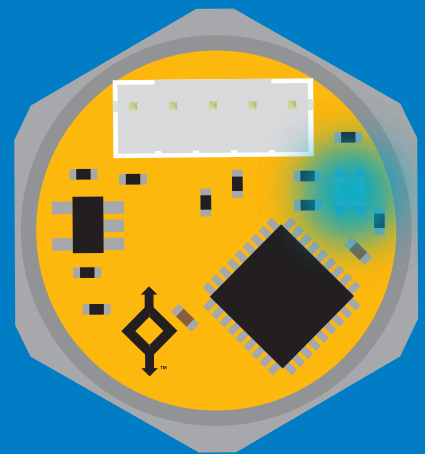

Change to UART mode

Command syntax

Baud,n switch from I²C to UART

Example

Baud,9600

Response

reboot in UART mode
(no response given)

n = [300
1200
2400
9600
19200
38400
57600
115200

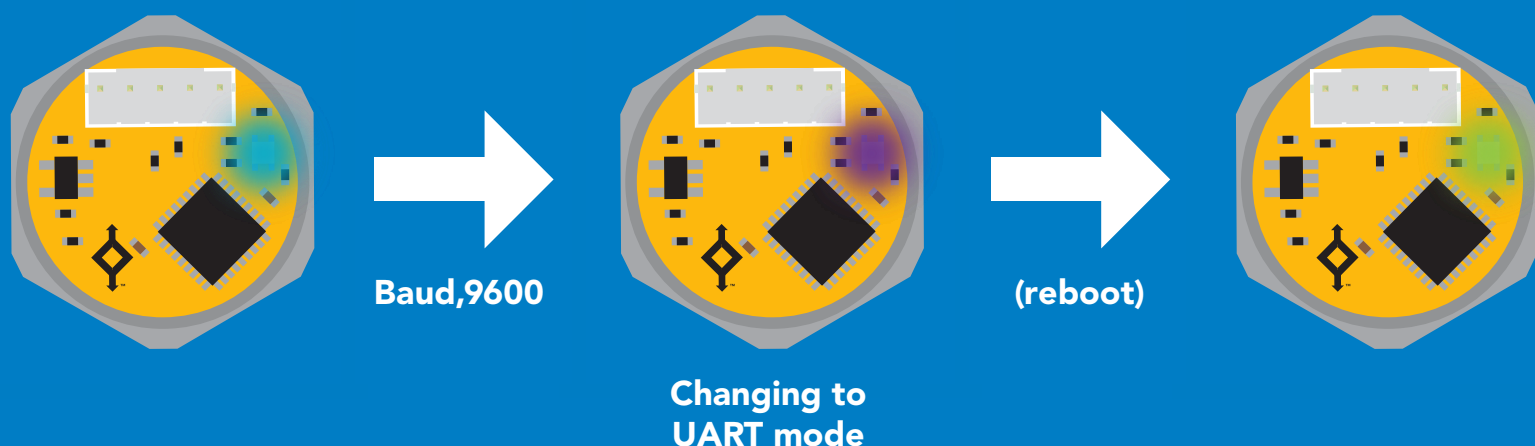

Manual switching to UART

- Disconnect ground (power off)
- Disconnect TX and RX
- Connect TX to INT
- Confirm RX is disconnected
- Connect ground (power on)
- Wait for LED to change from Blue to Green
- Disconnect ground (power off)
- Reconnect all data and power

Example

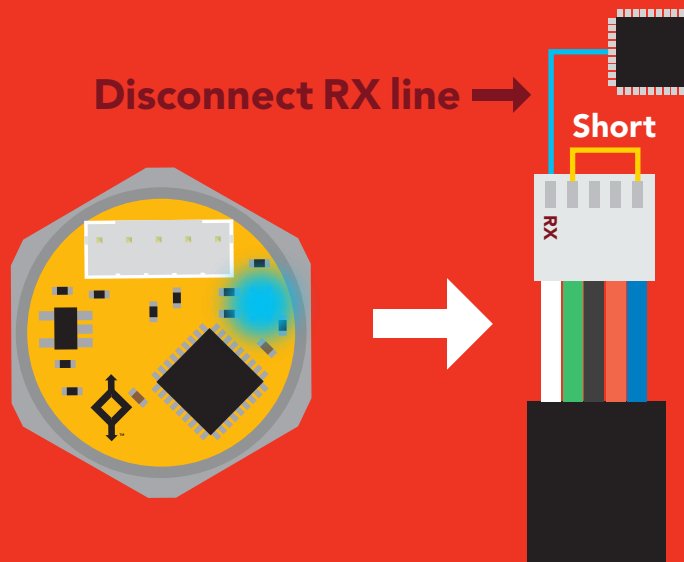
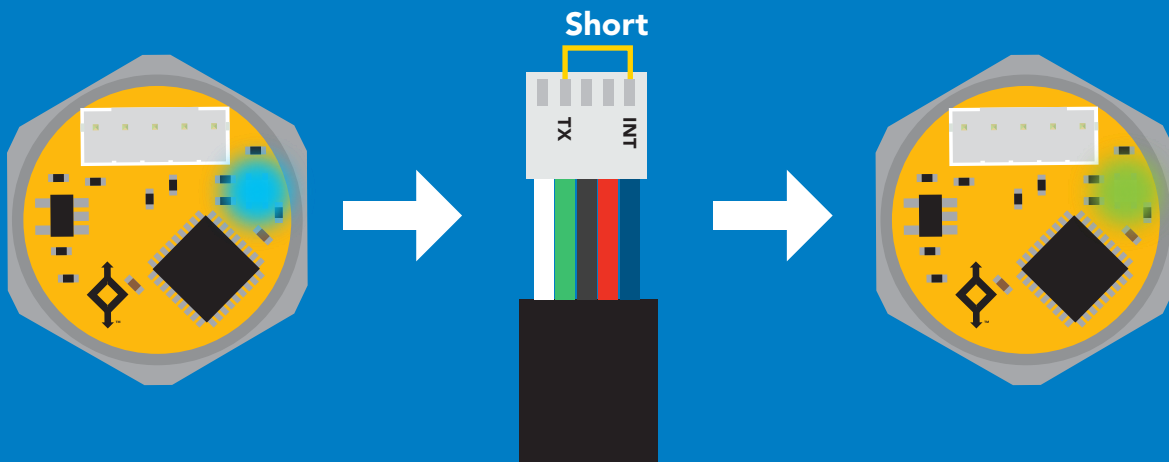

Datasheet change log

Datasheet V 2.0

Revised design of EZO-PRS throughout document.

Datasheet V 1.6

Revised naming device info on pages 25 & 49.

Datasheet V 1.5

Added the custom calibration pages on pages 22 & 46.

Datasheet V 1.4

Revised accuracy value on cover page.

Datasheet V 1.3

Revised pressure output in PSI to 50.000 on cover pg.
added inches of water & cm of water resolution info on pages 23 and 46.

Datasheet V 1.2

Updated firmware info on pg 55.

Datasheet V 1.1

Moved Default state to pg 9.

Datasheet V 1.0

Initial release - New datasheet

Firmware updates

V1.0 – Initial release (Aug, 7 2019)

V1.01 – (Nov, 5 2019)

- Fixed glitch where the alarm was not initially set correctly.

V1.02 – (April, 9 2021)

- Added custom calibration

Warranty

Atlas Scientific™ Warranties the EZO-PRS™ Embedded Pressure Sensor to be free of defect during the debugging phase of device implementation, or 30 days after receiving the EZO-PRS™ Embedded Pressure Sensor (which ever comes first).

The debugging phase

The debugging phase as defined by Atlas Scientific™ is the time period when the EZO-PRS™ Embedded Pressure Sensor is inserted into a bread board, or shield. If the EZO-PRS™ is being debugged in a bread board, the bread board must be devoid of other components. If the EZO-PRS™ Embedded Pressure Sensor is being connected to a microcontroller, the microcontroller must be running code that has been designed to drive the EZO-PRS™ Embedded Pressure Sensor exclusively and output the EZO-PRS™ data as a serial string.

It is important for the embedded systems engineer to keep in mind that the following activities will void the EZO-PRS™ Embedded Pressure Sensor warranty:

- **Soldering any part of the EZO-PRS™ Embedded Pressure Sensor.**
- **Running any code, that does not exclusively drive the EZO-PRS™ Embedded Dosing Pump and output its data in a serial string.**
- **Embedding the EZO-PRS™ Embedded Pressure Sensor into a custom made device.**
- **Removing any potting compound.**

Reasoning behind this warranty

Because Atlas Scientific™ does not sell consumer electronics; once the device has been embedded into a custom made system, Atlas Scientific™ cannot possibly warranty the EZO-PRS™ Embedded Pressure Sensor, against the thousands of possible variables that may cause the EZO-PRS™ Embedded Pressure Sensor to no longer function properly.

Please keep this in mind:

- 1. All Atlas Scientific™ devices have been designed to be embedded into a custom made system by you, the embedded systems engineer.**
- 2. All Atlas Scientific™ devices have been designed to run indefinitely without failure in the field.**
- 3. All Atlas Scientific™ devices can be soldered into place, however you do so at your own risk.**

Atlas Scientific™ is simply stating that once the device is being used in your application, Atlas Scientific can no longer take responsibility for the EZO-PRS™ Embedded Pressure Sensors continued operation. This is because that would be equivalent to Atlas Scientific™ taking responsibility over the correct operation of your entire device.