

ISOLATED DC/DC CONVERTERS

48 Vdc Input 1.2 Vdc - 12 Vdc / 8.33 A - 30 A Output, 1/8 Brick

bel
POWER PRODUCTS

0RCY-85T Series RoHS Compliant Rev.A

- Isolated
- High Efficiency
- High Power Density
- Fixed Frequency (300 kHz)
- Low Cost
- Input Under Voltage Lockout
- Safety Approval to UL60950-1 (UL/cUL)
- Pre-Bias Start Up
- Output Over Voltage Shutdown
- OCP/SCP
- Over Temperature Protection
- Remote On/Off
- Output Voltage Trim
- Positive/Negative Remote Sense
- Basic Insulation
- Pin Length (option)

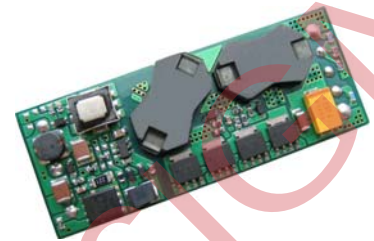

Description

The 0RCY-85T Series are isolated dc/dc converters that operate from a nominal 48 Vdc source. These units provide up to 100 W of output power. These units are designed to be highly efficient and cost-effective. Features include remote on/off, short circuit protection, over current protection, over temperature protection, input under voltage lockout, and output over voltage protection. These converters are provided in a compact, 1/8 brick industry standard package.

Part Selection

Output Voltage	Input Voltage	Max. Output Current	Max. Output Power	Typical Efficiency	Model Number Active High	Model Number Active Low
12.0 V	36 V - 75 V	8.33 A	100 W	91%	0RCY-85T120	0RCY-85T12L
5.0 V	36 V - 75 V	20 A	100 W	91%	0RCY-85T050	0RCY-85T05L
3.3 V	36 V - 75 V	25 A	85 W	90%	0RCY-85T033	0RCY-85T03L
2.5 V	36 V - 75 V	25 A	62.5 W	89%	0RCY-85T025	0RCY-85T02L
1.8 V	36 V - 75 V	25 A	45 W	88%	0RCY-85TV80	0RCY-85TV8L
1.5 V	36 V - 75 V	30 A	45 W	86%	0RCY-85TV50	0RCY-85TV5L
1.2 V	36 V - 75 V	30 A	36 W	84%	0RCY-85TV20	0RCY-85TV2L

Notes: 1. Change the last character to "M" to indicate 0.18" pin length and active low.

2. Add "G" suffix at the end of the model number to indicate Tray Packaging.

3. All part numbers above indicate RoHS 6. Change the second letter "R" to "7" for RoHS 5 part numbers.

Absolute Maximum Ratings

Parameter	Min	Typ	Max	Notes
Input Voltage (continuous)	-0.3 V	-	80 V	
Remote On/Off	-0.3 V	-	18 V	
I/O Isolation Voltage	-	-	2000 V	
Ambient Temperature	-40 °C	-	85 °C	
Storage Temperature	-55 °C	-	125 °C	

ISOLATED DC/DC CONVERTERS

48 Vdc Input 1.2 Vdc - 12 Vdc / 8.33 A - 30 A Output, 1/8 Brick



Input Specifications

Parameter	Min	Typ	Max	Notes
Input Voltage	36 V	48 V	75 V	
Input Current (full load)				
Vo=12.0 V	-	-	3.2 A	
Vo=5.0 V	-	-	3.2 A	
Vo=3.3 V	-	-	2.8 A	
Vo=2.5 V	-	-	2.2 A	
Vo=1.8 V	-	-	1.7 A	
Vo=1.5 V	-	-	1.7 A	
Vo=1.2 V	-	-	1.5 A	
Input Current (no load)				
Vo=12.0 V	-	65 mA	90 mA	
Vo=5.0 V	-	65 mA	90 mA	
Vo=3.3 V	-	60 mA	80 mA	
Vo=2.5 V	-	55 mA	75 mA	
Vo=1.8 V	-	50 mA	70 mA	
Vo=1.5 V	-	40 mA	60 mA	
Vo=1.2 V	-	35 mA	50 mA	
Remote Off Input Current		6 mA	12 mA	
Input Reflected Ripple Current (pk-pk)	-	12 mA	24 mA	Tested with simulated source impedance of 10 uH, 5 Hz to 20 MHz; use a 100 uF/100 V electrolytic capacitor with ESR = 1 ohm max. at 200 kHz at 25 °C.
Input Reflected Ripple Current (rms)	-	2 mA	4 mA	
I ² t Inrush Current Transient	-	0.01 A ² s	0.02 A ² s	
Turn-on Voltage Threshold	32 V	34 V	35 V	
Turn-off Voltage Threshold	30 V	32 V	33 V	

Output Specifications

Parameter	Min	Typ	Max	Notes
Output Voltage Set Point				Vin=48 V, Io=50% full load, Ta=25 °C.
Vo=12.0 V	11.760 V	12.0 V	12.24 V	
Vo=5.0 V	4.925 V	5.0 V	5.075 V	
Vo=3.3 V	3.250 V	3.3 V	3.350 V	
Vo=2.5 V	2.463 V	2.5 V	2.538 V	
Vo=1.8 V	1.773 V	1.8 V	1.827 V	
Vo=1.5 V	1.477 V	1.5 V	1.523 V	
Vo=1.2 V	1.182 V	1.2 V	1.218 V	
Line Regulation				
Vo=12.0 V-3.3 V	-	±2 mV	±5 mV	
Vo=1.2 V-2.5 V	-	±1 mV	±3 mV	
Load Regulation				
Vo=12.0 V	-	±8 mV	±16 mV	
Vo=5.0 V	-	±8 mV	±16 mV	
Vo=3.3 V	-	±6 mV	±12 mV	
Vo=2.5 V	-	±4 mV	±8 mV	
Vo=1.8 V	-	±3 mV	±6 mV	
Vo=1.5 V	-	±3 mV	±6 mV	
Vo=1.2 V	-	±2 mV	±4 mV	

ISOLATED DC/DC CONVERTERS

48 Vdc Input 1.2 Vdc - 12 Vdc / 8.33 A - 30 A Output, 1/8 Brick



Output Specifications (continued)

Parameter	Min	Typ	Max	Notes		
Regulation Over Temperature (-40 °C to +85 °C)						
Vo=12.0 V	-	±50 mV	±75 mV			
Vo=5.0 V	-	±50 mV	±75 mV			
Vo=3.3 V	-	±20 mV	±40 mV			
Vo=2.5 V	-	±15 mV	±30 mV			
Vo=1.8 V	-	±15 mV	±30 mV			
Vo=1.5 V	-	±10 mV	±20 mV			
Vo=1.2 V	-	±10 mV	±20 mV			
Output Current						
Vo=12.0 V	0 A	-	8.33 A			
Vo=5.0 V	0 A	-	20 A			
Vo=3.3 V	0 A	-	25 A			
Vo=2.5 V	0 A	-	25 A			
Vo=1.8 V	0 A	-	25 A			
Vo=1.5 V	0 A	-	30 A			
Vo=1.2 V	0 A	-	30 A			
Current Limit Threshold						
Vo=12.0 V	10 A	13 A	16 A			
Vo=5.0 V	23 A	29 A	35 A			
Vo=3.3 V	30 A	36 A	42 A			
Vo=2.5 V	27 A	33 A	40 A			
Vo=1.8 V	27 A	33 A	40 A			
Vo=1.5 V	32 A	36 A	45 A			
Vo=1.2 V	32 A	36 A	45 A			
Short Circuit Surge Transient	-	3 A ² s	5 A ² s			
Ripple and Noise (rms)				Test conditions: 0-20 MHz BW, with a 1 uF ceramic capacitor and a 10 uF Tantalum capacitor at the output.		
Vo=12.0 V	-	30 mV	50 mV			
Vo=5.0 V	-	25 mV	50 mV			
Vo=1.2 V-3.3 V	-	15 mV	30 mV			
Ripple and Noise (pk-pk)				Test conditions: 0-20 MHz BW, with a 1 uF ceramic capacitor and a 10 uF Tantalum capacitor at the output.		
Vo=12.0 V	-	100 mV	150 mV			
Vo=5.0 V	-	80 mV	120 mV			
Vo=3.3 V	-	45 mV	90 mV			
Vo=1.2 V-2.5 V	-	40 mV	80 mV			
Turn on Time	-	-	30 mS			
Overshoot at Turn on	-	0%	5%			
Output Capacitance						
Vo=12.0 V	0 uF	-	1000 uF			
Vo=5.0 V	0 uF	-	10000 uF			
Vo=1.2 V- 3.3 V	0 uF	-	20000 uF			
Transient Response						
25% ~ 50% Max Load	Overshoot	Vo=12.0 V	-	300 mV	400 mV	Test conditions: di/dt = 0.1 A/uS, Vin=48 V, with a 1 uF ceramic capacitor and a 10 uF Tantalum capacitor at the output.
	Settling Time		-	200 uS	300 uS	
50% ~ 25% Max Load	Overshoot	Vo=12.0 V	-	300 mV	400 mV	
	Settling Time		-	200 uS	300 uS	
25% ~ 50% Max Load	Overshoot	Vo=5.0 V	-	200 mV	300 mV	
	Settling Time		-	200 uS	300 uS	
50% ~ 25% Max Load	Overshoot	Vo=5.0 V	-	200 mV	300 mV	
	Settling Time		-	200 uS	300 uS	
25% ~ 50% Max Load	Overshoot	Vo=3.3 V	-	150 mV	200 mV	
	Settling Time		-	200 uS	300 uS	
50% ~ 25% Max Load	Overshoot	Vo=3.3 V	-	150 mV	200 mV	
	Settling Time		-	200 uS	300 uS	

ISOLATED DC/DC CONVERTERS

48 Vdc Input 1.2 Vdc - 12 Vdc / 8.33 A - 30 A Output, 1/8 Brick

bel
POWER PRODUCTS

Output Specifications (continued)

Parameter		Min	Typ	Max	Notes
Transient Response					
25% ~ 50% Max Load	Overshoot	Vo=2.5 V	-	150 mV	200 mV
	Settling Time		-	150 μ S	200 μ S
50% ~ 25% Max Load	Overshoot	Vo=2.5 V	-	150 mV	200 mV
	Settling Time		-	150 μ S	200 μ S
25% ~ 50% Max Load	Overshoot	Vo=1.8 V	-	140 mV	170 mV
	Settling Time		-	150 μ S	200 μ S
50% ~ 25% Max Load	Overshoot	Vo=1.8 V	-	140 mV	170 mV
	Settling Time		-	150 μ S	200 μ S
25% ~ 50% Max Load	Overshoot	Vo=1.5 V	-	130 mV	150 mV
	Settling Time		-	150 μ S	200 μ S
50% ~ 25% Max Load	Overshoot	Vo=1.5 V	-	130 mV	150 mV
	Settling Time		-	150 μ S	200 μ S
25% ~ 50% Max Load	Overshoot	Vo=1.2 V	-	120 mV	140 mV
	Settling Time		-	150 μ S	200 μ S
50% ~ 25% Max Load	Overshoot	Vo=1.2 V	-	120 mV	140 mV
	Settling Time		-	150 μ S	200 μ S

Test conditions: di/dt = 0.1 A/ μ S, Vin=48 V, with a 1 μ F ceramic capacitor and a 10 μ F Tantalum capacitor at the output.

Note: All specifications are typical at 25 °C unless otherwise stated.

General Specifications

Parameter		Min	Typ	Max	Notes
Efficiency	Vo=12.0 V	88%	91%	-	Vin=48V, Io=Io, max
	Vo=5.0 V	88%	91%	-	
	Vo=3.3 V	87%	90%	-	
	Vo=2.5 V	86%	89%	-	
	Vo=1.8 V	85%	88%	-	
	Vo=1.5 V	83%	86%	-	
	Vo=1.2 V	81%	84%	-	
Switching Frequency		270 kHz	300 kHz	330 kHz	
Isolation capacitance		-	1500 pF	-	
Output Voltage Trim Range	Vo=1.5 V-12 V	80% Vo	-	110% Vo	The total voltage increased by trim and remote sense should not exceed 10%Vo.
	Vo=1.2 V	90% Vo	-	110% Vo	
Remote Sense		-	-	10%	
Over Temperature Protection		-	125 °C	-	
Over Voltage Protection		-	130% Vo	-	Vin=48V, full load, in hiccup mode.
Pre-bias Voltage	Vo=5.0 V	-	-	4.0 V	
	Vo=3.3 V	-	-	1.4 V	
	Vo=2.5 V	-	-	2.0 V	
	Vo=1.8 V	-	-	1.4 V	
	Vo=1.5 V	-	-	1.2 V	
	Vo=1.2 V	-	-	0.9 V	
MTBF		1,583,176 hours			Calculated Per Bell Core SR-332 (Vin=48 V, Vo=3.3 V, Io=20 A, Ta = 25 °C)
Dimensions	Inches (L x W x H)	2.30 x 0.896 x 0.395			
	Millimeters (L x W x H)	58.42 x 22.76 x 10.03			
Weight		-	27 g	-	

Note: All specifications are typical at 25 °C unless otherwise stated.

ISOLATED DC/DC CONVERTERS

48 Vdc Input 1.2 Vdc - 12 Vdc / 8.33 A - 30 A Output, 1/8 Brick

bel
POWER PRODUCTS

Control Specifications

Parameter	Min	Typ	Max	Notes	
Remote On/Off					
Signal Low (Unit On)	Active Low	-0.3 V	-	0.8 V	0RCY-85TxxL. The remote on/off pin open, Unit off.
Signal High (Unit Off)		2.4 V	-		
Signal Low (Unit Off)	Active High	-0.3 V	-	0.8 V	0RCY-85Txx0. The remote on/off pin open, Unit on.
Signal High (Unit On)		2.4 V	-		
Current Sink	0 mA	-	0.75 mA		

Output Trim Equations

Equations for calculating the trim resistor are shown below. The Trim Down resistor should be connected between the Trim pin and Ground pin. The Trim Up resistor should be connected between the Trim pin and the Vout. Only one of the resistors should be used for any given application.

$$R_{trim-down} = \frac{511}{|\delta|} - 10.22 [k\Omega]$$

Vo=1.5 V-12 V:

$$R_{trim-up} = \frac{(100 + \delta) \cdot V_o \cdot 5.11 - 626}{1.225 \cdot \delta} - 10.22 [k\Omega]$$

Vo=1.2 V:

$$R_{trim-up} = \frac{(100 + \delta) \cdot V_o \cdot 5.11 - 313}{0.6125 \cdot \delta} - 10.22 [k\Omega]$$

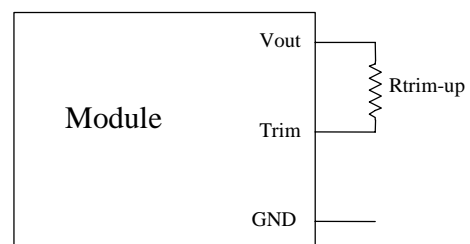
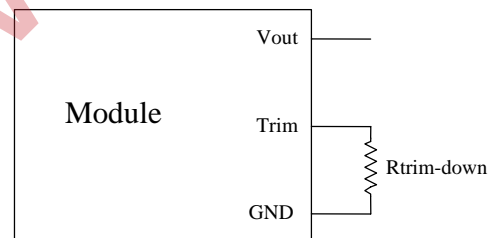

Notes:

$$\delta = \frac{(V_o_{req} - V_o)}{V_o} \times 100 [\%]$$

Vo_req=Desired (trimmed) output voltage [V]

Output voltage Vo=1.202 V for 1.2 V output; Vo=1.503 V for 1.5 V output; Vo=1.804 V for 1.8 V; Vo=2.505 V for 2.5 V output; Vo=3.308 V for 3.3 V output; Vo=5.000 V for 5.0 V; Vo=12.000 V for 12 V output

ISOLATED DC/DC CONVERTERS

48 Vdc Input 1.2 Vdc - 12 Vdc / 8.33 A - 30 A Output, 1/8 Brick



Efficiency Data

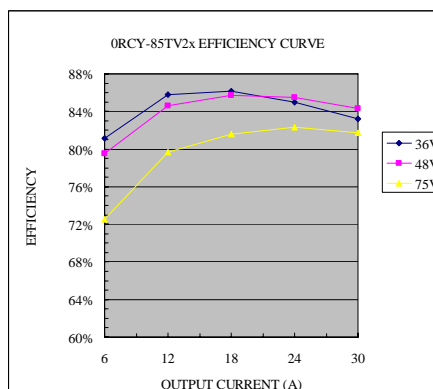
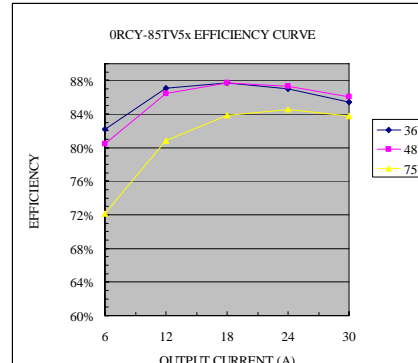
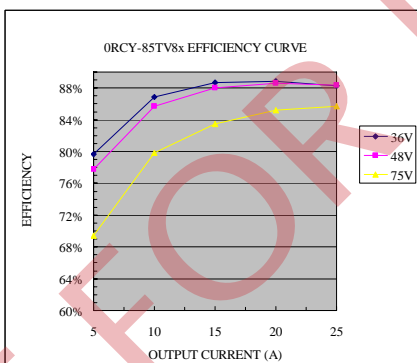
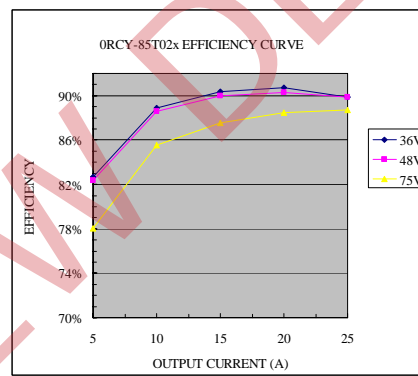
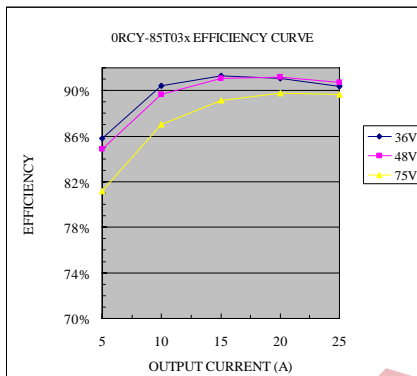
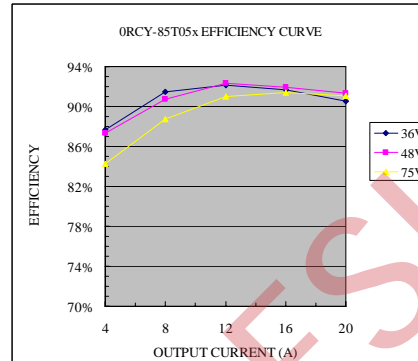
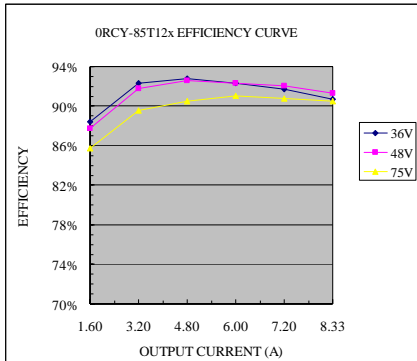

ISOLATED DC/DC CONVERTERS

48 Vdc Input 1.2 Vdc - 12 Vdc / 8.33 A - 30 A Output, 1/8 Brick



Thermal Derating Curves

Vin=48V, with maximum junction temperature of semiconductors derated to 120 degree C.

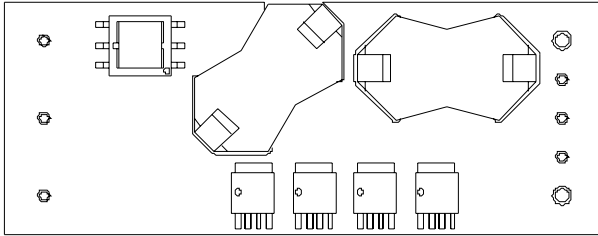

Forced Airflow Direction

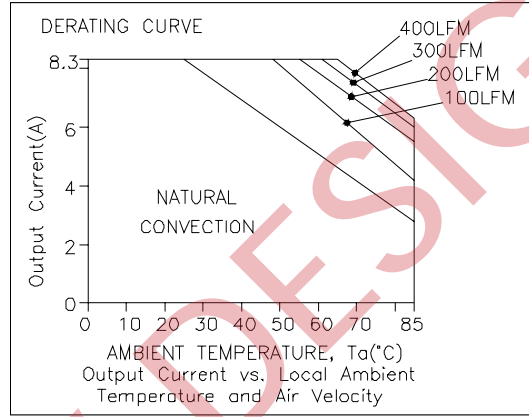

ORCY-85T12x

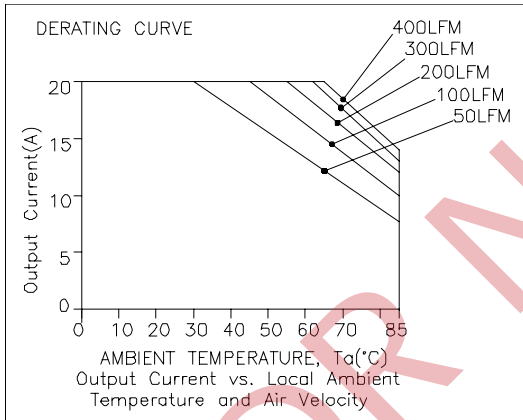

ORCY-85T05x

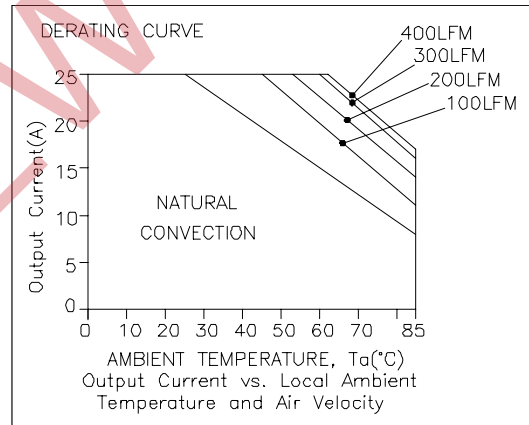

ORCY-85T03x

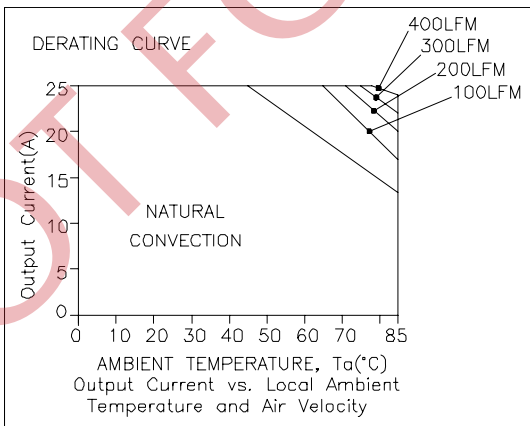

ORCY-85T02x

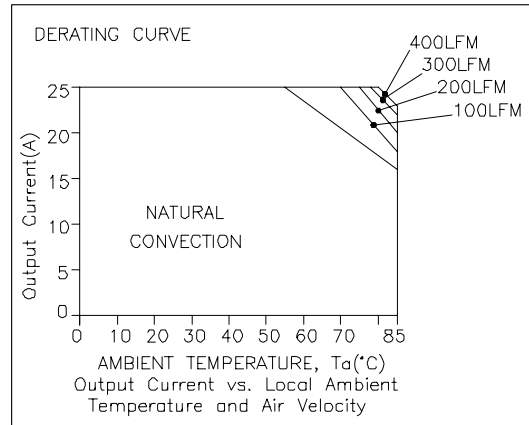

ORCY-85TV8x

ISOLATED DC/DC CONVERTERS

48 Vdc Input 1.2 Vdc - 12 Vdc / 8.33 A - 30 A Output, 1/8 Brick



Thermal Derating Curves (continued)

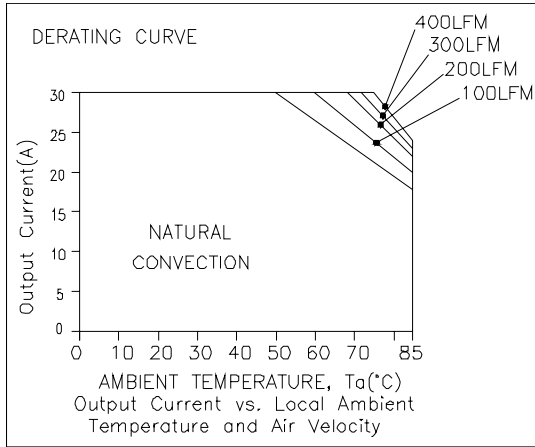

ORCY-85TV5x

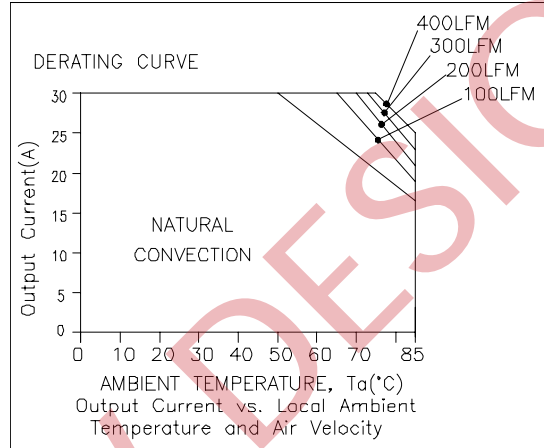

ORCY-85TV2x

Thermal Reference

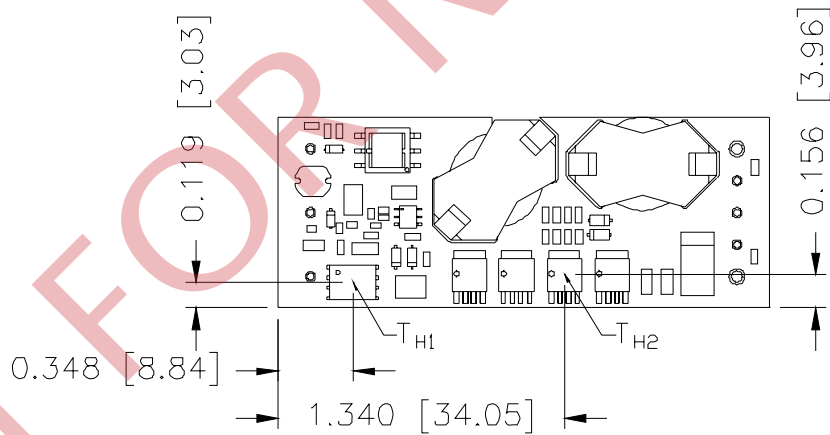

Note: T_{H1} and T_{H2} are hot spots which should not exceed 118 degree C.

ISOLATED DC/DC CONVERTERS

48 Vdc Input 1.2 Vdc - 12 Vdc / 8.33 A - 30 A Output, 1/8 Brick



Ripple and Noise Waveforms

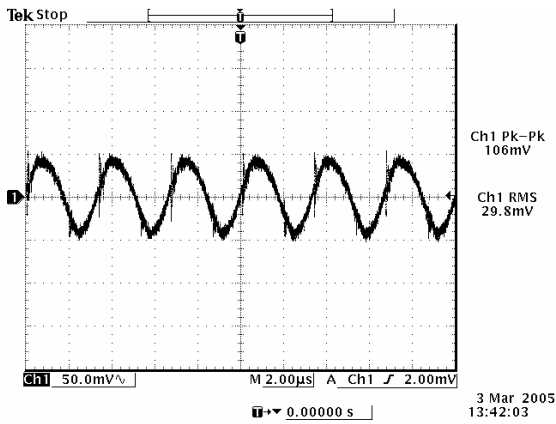

Ripple and noise at max load 12 Vdc/8.33 A output

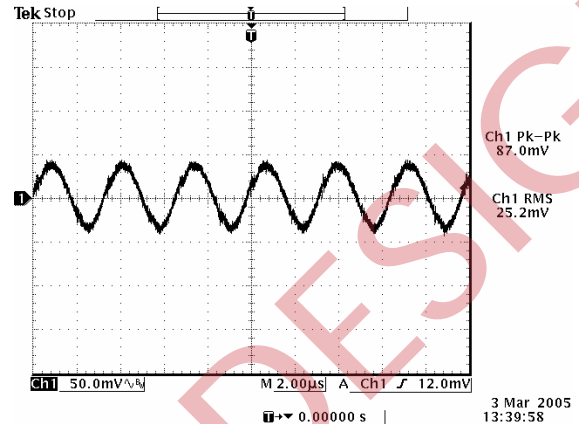

Ripple and noise at max load 5.0 Vdc/20 A output

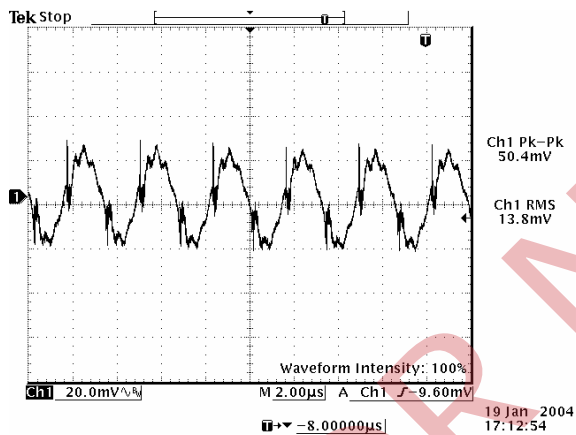

Ripple and noise at max load 3.3 Vdc/25 A output

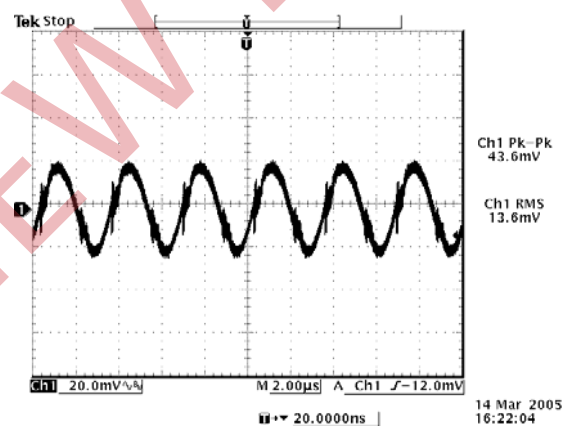

Ripple and noise at max load 2.5 Vdc/25 A output

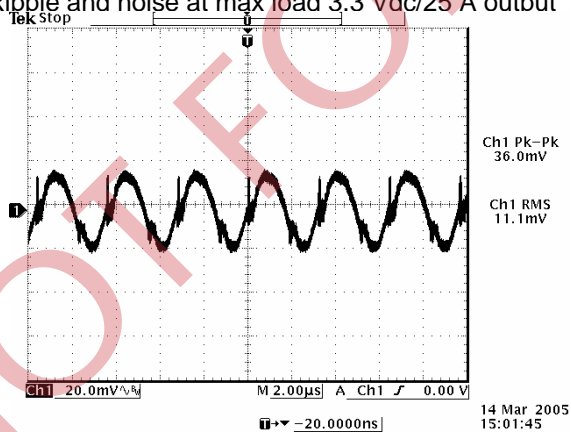

Ripple and noise at max load 1.8 Vdc/25 A output

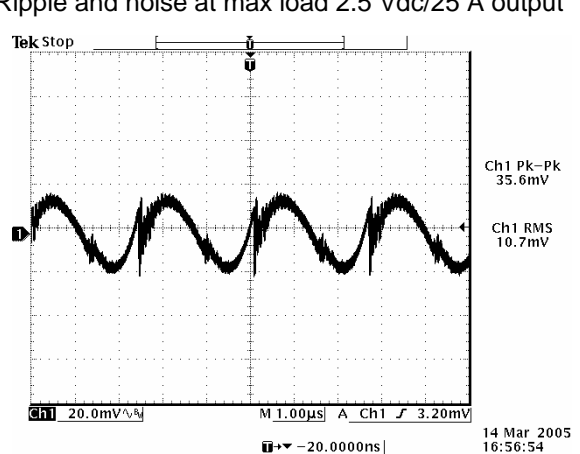

Ripple and noise at max load 1.5 Vdc/30 A output

ISOLATED DC/DC CONVERTERS

48 Vdc Input 1.2 Vdc - 12 Vdc / 8.33 A - 30 A Output, 1/8 Brick



Ripple and Noise Waveforms (continued)

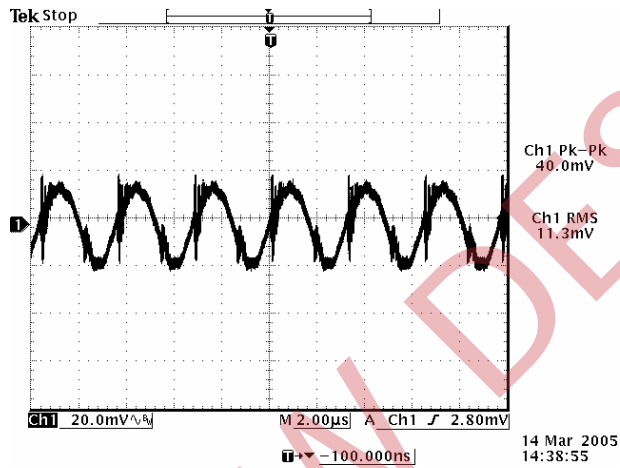

Ripple and noise at max load 1.2 Vdc/30 A output

Note: Ripple and Noise at 48 V input, with a 1 uF ceramic capacitor and a 10 uF tantalum capacitor at the output, and Ta=25 deg C

Transient Response Waveforms

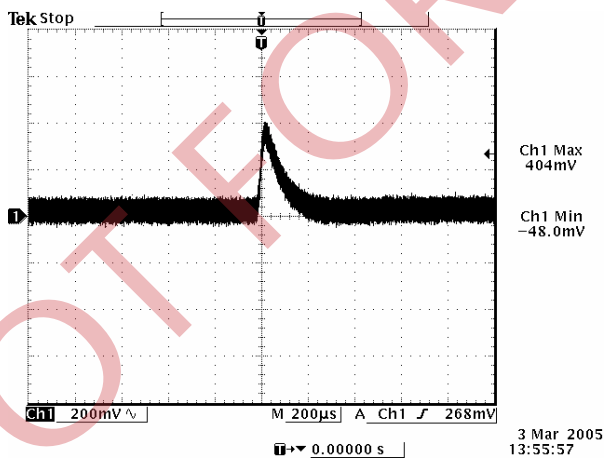

Transients 50% to 25% load 12 Vdc output

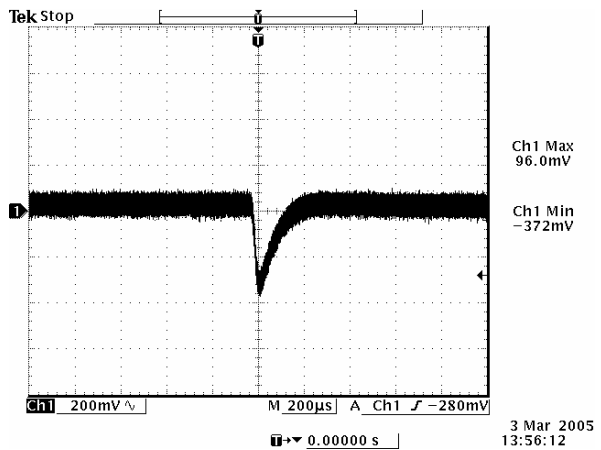

Transients 25% to 50% load 12 Vdc output

ISOLATED DC/DC CONVERTERS

48 Vdc Input 1.2 Vdc - 12 Vdc / 8.33 A - 30 A Output, 1/8 Brick



Transient Response Waveforms (continued)

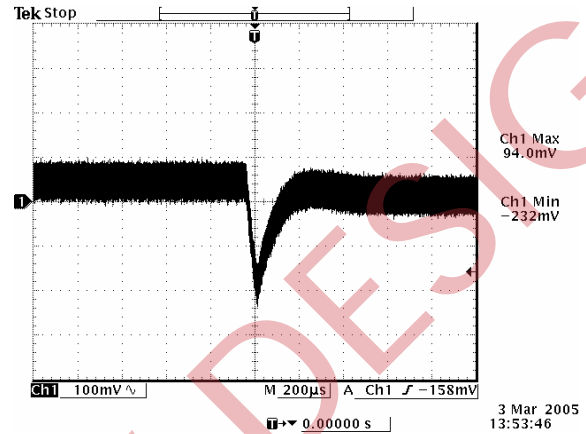
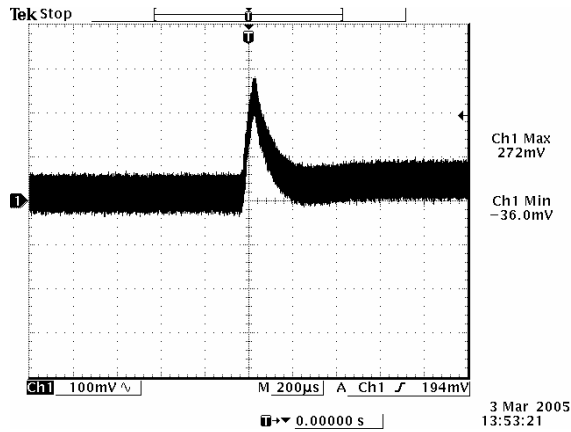

Transients 50% to 25% load 5.0 Vdc output

Transients 25% to 50% load 5.0 Vdc output

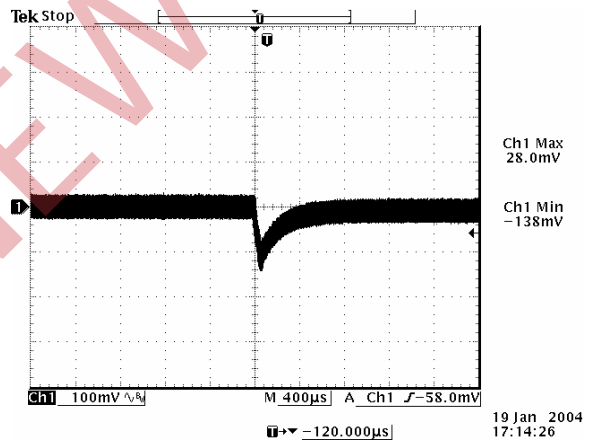
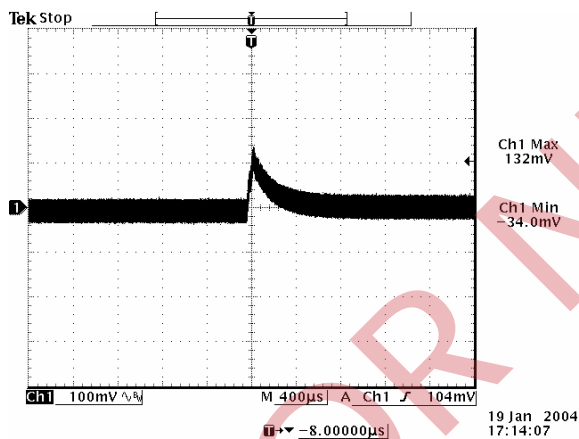

Transients 50% to 25% load 3.3 Vdc output

Transients 25% to 50% load 3.3 Vdc output

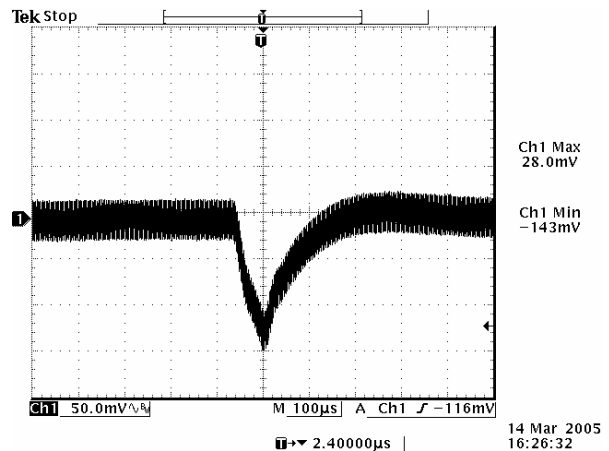
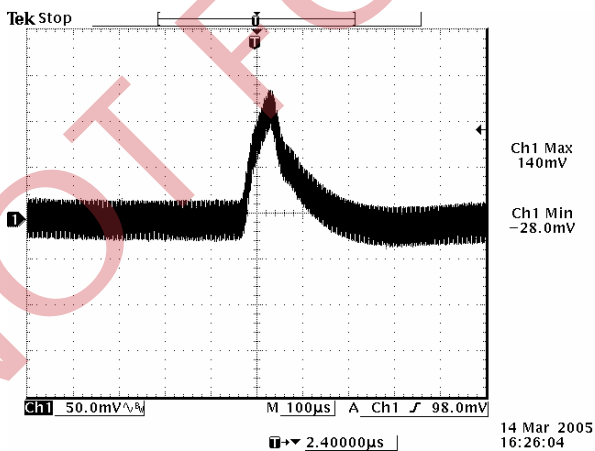

Transients 50% to 25% load 2.5 Vdc output

Transients 25% to 50% load 2.5 Vdc output

ISOLATED DC/DC CONVERTERS

48 Vdc Input 1.2 Vdc - 12 Vdc / 8.33 A - 30 A Output, 1/8 Brick



Transient Response Waveforms (continued)

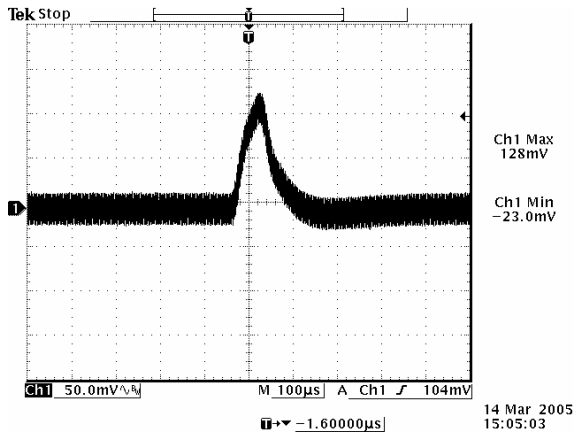

Transients 50% to 25% load 1.8 Vdc output

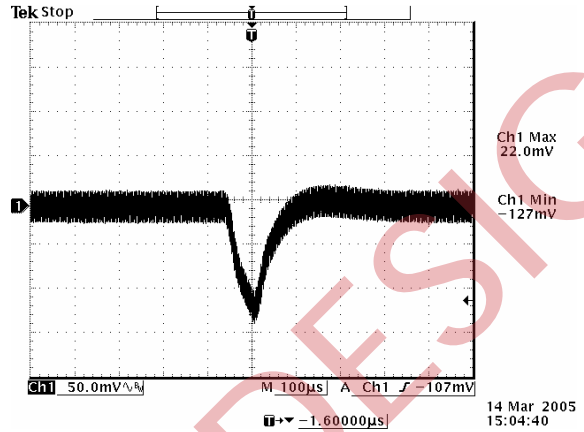

Transients 25% to 50% load 1.8 Vdc output

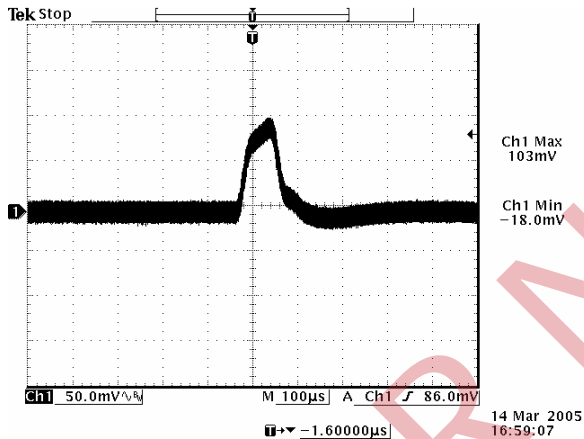

Transients 50% to 25% load 1.5 Vdc output

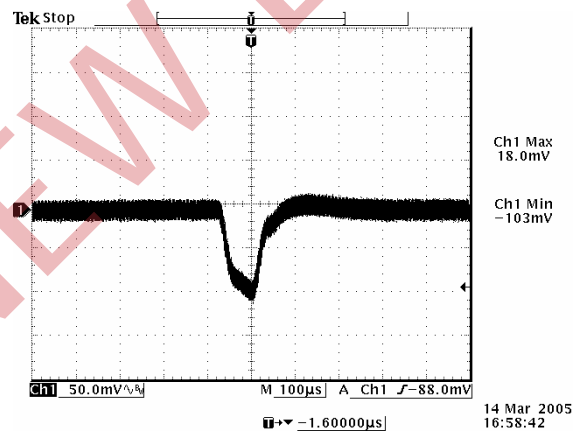

Transients 25% to 50% load 1.5 Vdc output

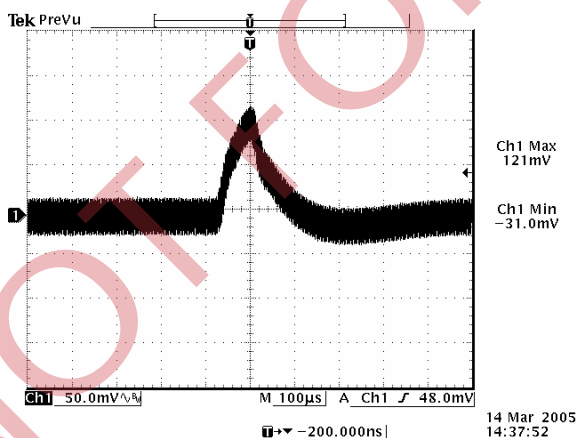

Transients 50% to 25% load 1.2 Vdc output

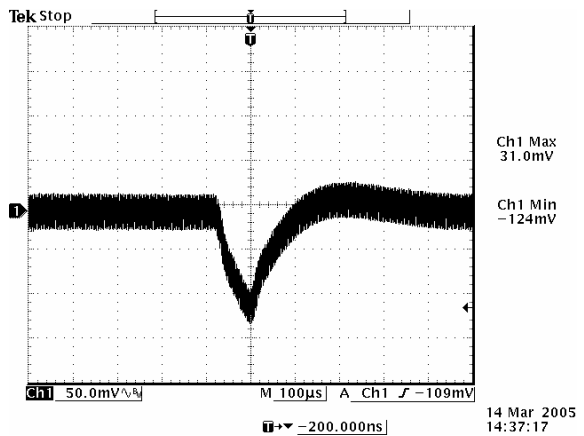

Transients 25% to 50% load 1.2 Vdc output

Note: Transient response at 48 V input, $di/dt=0.1$ A/uS, with external 10 uF tantalum cap and 1 uF ceramic cap at the output, $T_a=25$ deg C.

ISOLATED DC/DC CONVERTERS

48 Vdc Input 1.2 Vdc - 12 Vdc / 8.33 A - 30 A Output, 1/8 Brick



Mechanical Outline

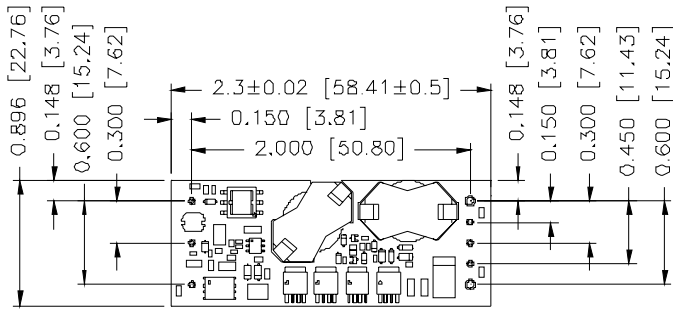

TOP VIEW

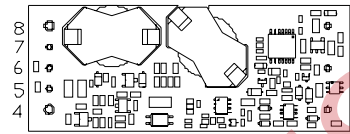

BOTTOM VIEW

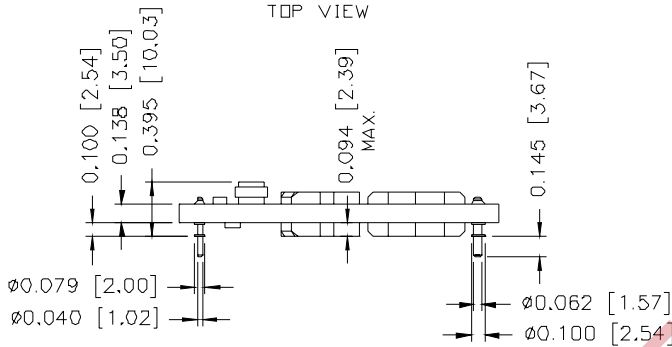

RECOMMENDED PAD LAYOUT

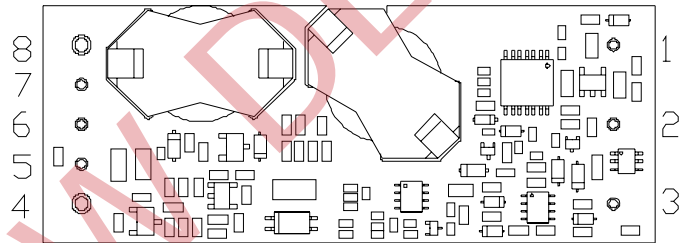

BOTTOM VIEW

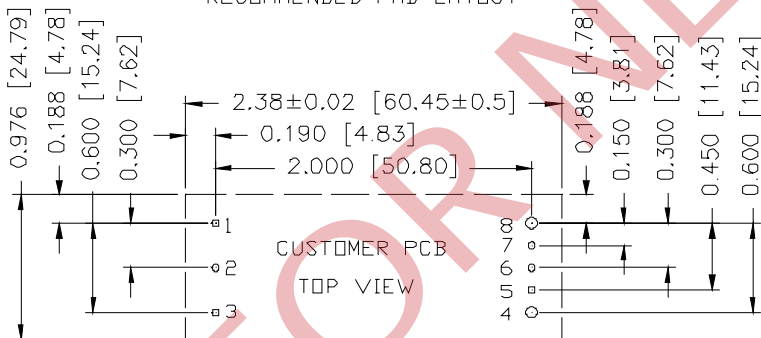

CUSTOMER PCB
TOP VIEW

1,2,3,5,6,7 Ø0.047 HOLE SIZE, Ø0.08 min PAD SIZE
4,8 Ø0.07 HOLE SIZE, Ø0.10 min PAD SIZE

Pin Connections

Pin	Function	Pin Dia
1	Vin+	0.040"
2	Remote On/Off	0.040"
3	Vin-	0.040"
4	Vout-	0.062"
5	Sense-	0.040"
6	Trim	0.040"
7	Sense+	0.040"
8	Vout+	0.062"

RoHS Compliance

Complies with the European Directive 2002/95/EC, calling for the elimination of lead and other hazardous substances from electronic products.



©2007 Bel Fuse Inc. Specifications subject to change without notice. 010507

CORPORATE

Bel Fuse Inc.
206 Van Vorst Street
Jersey City, NJ 07302
Tel 201-432-0463
Fax 201-432-9542
www.belfuse.com

FAR EAST

Bel Fuse Ltd.
8F/ 8 Luk Hop Street
San Po Kong
Kowloon, Hong Kong
Tel 852-2328-5515
Fax 852-2352-3706
www.belfuse.com

EUROPE

Bel Fuse Europe Ltd.
Preston Technology Management Centre
Marsh Lane, Suite G7, Preston
Lancashire, PR1 8UD, U.K.
Tel 44-1772-556601
Fax 44-1772-888366
www.belfuse.com