

## ALS70A362QC450

Aliases (A390UE362M450A)

ALS70, Aluminum Electrolytic, 3,600 uF, 20%, 450 VDC, -40/+85°C

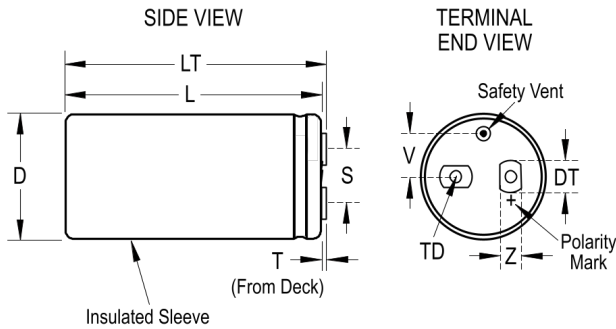

Click [here](#) for the 3D model.

### Dimensions

D	90mm +/-1mm
L	67mm +/-2mm
T	5.5mm +/-0.5mm
S	31.8mm +/-0.5mm
DT	13mm +/-0.5mm
LT	71.5mm +/-1mm
TD	10mm MIN
V	25mm NOM
Z	10mm NOM

### Packaging Specifications

Sleeving	Yes
Packaging	Tray

### General Information

Series	ALS70
Dielectric	Aluminum Electrolytic
Description	Screw Terminal, Aluminum Electrolytic
RoHS	Yes
AEC-Q200	No
Halogen Free	Yes
Component Weight	615 g
Notes	Dimensions D And L Include Sleeving. MS (MxH) = M12x16. Mounting Clamp (Sold Separately): V90N
Shelf Life	156 Weeks

### Specifications

Capacitance	3,600 uF
Capacitance Tolerance	20%
Voltage DC	450 VDC, 495 VDC (Surge)
Temperature Range	-40/+85°C
Rated Temperature	85°C
Life	20000 Hrs (Rated Voltage And Ripple Current At 85C), 40000 Hrs (Rated Voltage At 85C)
Resistance	61 mOhms (100Hz 20C), 41 mOhms (10kHz 20C)
Ripple Current	11.8 Amps (100Hz 85C), 17.5 Amps (10kHz 85C)
Leakage Current	6000 uA