

FEATURES

- SNR = 65 dBFS at f_{IN} up to 250 MHz at 500 MSPS**
- ENOB of 10.5 bits at f_{IN} up to 250 MHz at 500 MSPS (−1.0 dBFS)**
- SFDR = 78 dBc at f_{IN} up to 250 MHz at 500 MSPS (−1.0 dBFS)**
- Integrated input buffer**
- Excellent linearity**
 - DNL = ±0.5 LSB typical**
 - INL = ±0.6 LSB typical**
- LVDS at 500 MSPS (ANSI-644 levels)**
- 1 GHz full power analog bandwidth**
- On-chip reference, no external decoupling required**
- Low power dissipation**
 - 690 mW at 500 MSPS—LVDS SDR mode**
 - 660 mW at 500 MSPS—LVDS DDR mode**
- Programmable (nominal) input voltage range**
 - 1.18 V p-p to 1.6 V p-p, 1.5 V p-p nominal**
- 1.8 V analog and digital supply operation**
- Selectable output data format (offset binary, twos complement, Gray code)**
- Clock duty cycle stabilizer**
- Integrated data clock output with programmable clock and data alignment**

APPLICATIONS

- Wireless and wired broadband communications**
- Cable reverse path**
- Communications test equipment**
- Radar and satellite subsystems**
- Power amplifier linearization**

GENERAL DESCRIPTION

The **AD9434** is a 12-bit monolithic sampling analog-to-digital converter (ADC) optimized for high performance, low power, and ease of use. The part operates at up to a 500 MSPS conversion rate and is optimized for outstanding dynamic performance in wideband carrier and broadband systems. All necessary functions, including a sample-and-hold and voltage reference, are included on the chip to provide a complete signal conversion solution. The VREF pin can be used to monitor the internal reference or provide an external voltage reference (external reference mode must be enabled through the SPI port).

The ADC requires a 1.8 V analog voltage supply and a differential clock for full performance operation. The digital outputs are LVDS (ANSI-644) compatible and support twos complement, offset binary format, or Gray code. A data clock output is available for proper output data timing.

Rev. B

[Document Feedback](#)

Information furnished by Analog Devices is believed to be accurate and reliable. However, no responsibility is assumed by Analog Devices for its use, nor for any infringements of patents or other rights of third parties that may result from its use. Specifications subject to change without notice. No license is granted by implication or otherwise under any patent or patent rights of Analog Devices. Trademarks and registered trademarks are the property of their respective owners.

FUNCTIONAL BLOCK DIAGRAM

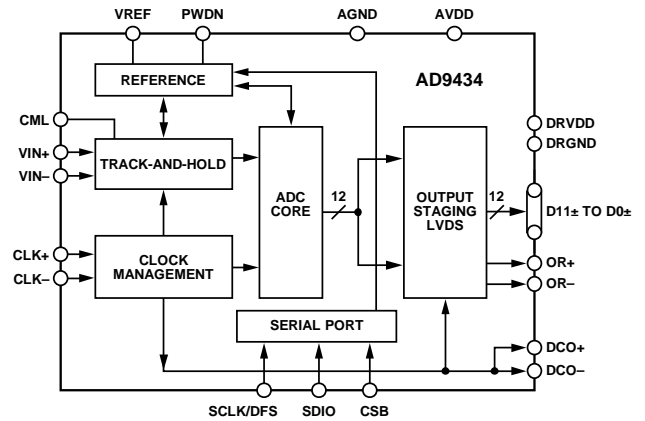

Figure 1.

Fabricated on an advanced BiCMOS process, the **AD9434** is available in a 56-lead LFCSP, specified over the industrial temperature range (−40°C to +85°C). This part is protected under a U.S. patent.

PRODUCT HIGHLIGHTS

1. **High Performance.**
Maintains 65 dBFS SNR at 500 MSPS with a 250 MHz input.
2. **Low Power.**
Consumes only 660 mW at 500 MSPS.
3. **Ease of Use.**
LVDS output data and output clock signal allow interface to FPGA technology. The on-chip reference and sample-and-hold provide flexibility in system design. Use of a single 1.8 V supply simplifies system power supply design.
4. **Serial Port Control.**
Standard serial port interface supports various product functions, such as data formatting, power-down, gain adjust, and output test pattern generation.
5. The **AD9434** is pin compatible with the **AD9230**, and can be substituted in many applications with minimal design changes.

TABLE OF CONTENTS

Features	1	Theory of Operation	19
Applications	1	Analog Input and Voltage Reference	19
General Description	1	Clock Input Considerations	20
Functional Block Diagram	1	Power Dissipation and Power-Down Mode	21
Product Highlights	1	Digital Outputs	21
Revision History	2	Timing	22
Specifications	3	VREF	22
DC Specifications	3	AD9434 Configuration Using the SPI	22
AC Specifications	4	Using the AD9434 to Replace the AD9230	23
Digital Specifications	5	Hardware Interface	23
Switching Specifications	6	Configuration Without the SPI	23
Timing Diagrams	7	Memory Map	25
Absolute Maximum Ratings	8	Reading the Memory Map Table	25
Thermal Resistance	8	Reserved Locations	25
ESD Caution	8	Default Values	25
Pin Configurations and Function Descriptions	9	Logic Levels	25
Typical Performance Characteristics	13	Outline Dimensions	28
Equivalent Circuits	18	Ordering Guide	28

REVISION HISTORY

2/13—Rev. A to Rev. B

Changes to Table 4	6
Changes to Table 5	8
Changes to Reading the Memory Map Table Section	25

5/11—Rev. 0 to Rev. A

Changes to General Description	1
Changes to Table 4, Aperture Time Values	6
Changes to Figure 32	17
Changes to Figure 42	19
Changes to Table 13, Register 10, Bits[7:0] Value, Register 14 Default Value, Register 15 Default Value, Register 17, Bit 7 Value and Register 18, Bit[4:0] Values	26

3/11—Revision 0: Initial Version

SPECIFICATIONS

DC SPECIFICATIONS

AVDD = 1.8 V, DRVDD = 1.8 V, T_{MIN} = -40°C, T_{MAX} = +85°C, f_{IN} = -1.0 dBFS, full scale = 1.5 V, unless otherwise noted.

Table 1.

Parameter ¹	Temp	AD9434-370			AD9434-500			Unit
		Min	Typ	Max	Min	Typ	Max	
RESOLUTION		12			12			Bits
ACCURACY		Guaranteed			Guaranteed			
No Missing Codes	Full	Guaranteed			Guaranteed			
Offset Error	25°C	±0.25			±0.25			mV
Gain Error	Full	-3.0		+1.0	-3.0		+1.0	mV
	25°C	1.0			1.0			% FS
Differential Nonlinearity (DNL)	Full	-5.0		+7.0	-5.0		+7.0	% FS
	25°C	±0.4			±0.5			LSB
Integral Nonlinearity (INL)	Full	-0.9		+0.9	-0.95		+1.0	LSB
	25°C	±0.4			±0.6			LSB
	Full	-0.92		+0.92	-1.3		+1.3	LSB
INTERNAL REFERENCE								
VREF	Full	0.71	0.75	0.78	0.71	0.75	0.78	V
TEMPERATURE DRIFT								
Offset Error	Full	18			18			μV/°C
Gain Error	Full	0.07			0.07			%/°C
ANALOG INPUTS (VIN+, VIN-)								
Differential Input Voltage Range ²	Full	1.18	1.5	1.6	1.18	1.5	1.6	V p-p
Input Common-Mode Voltage	Full	1.7			1.7			V
Input Resistance (Differential)	Full	1			1			kΩ
Input Capacitance (Differential)	25°C	1.3			1.3			pF
POWER SUPPLY								
AVDD	Full	1.75	1.8	1.9	1.75	1.8	1.9	V
DRVDD	Full	1.75	1.8	1.9	1.75	1.8	1.9	V
Supply Currents								
I _{AVDD} ³	Full	260		280	283		301	mA
I _{DRVDD} ³ /SDR Mode ⁴	Full	88		100	100		114	mA
I _{DRVDD} ³ /DDR Mode ⁵	Full	70		80	82		96	mA
Power Dissipation								
SDR Mode ⁴	Full	625		685	690		747	mW
DDR Mode ⁵	Full	595		648	657		715	mW
Standby Mode	Full	40		50	40		50	mW
Power-Down Mode	Full	2.5		7	2.5		7	mW

¹ See the AN-835 Application Note, *Understanding High Speed ADC Testing and Evaluation*, for a complete set of definitions and how these tests were completed.

² The input range is programmable through the SPI, and the range specified reflects the nominal values of each setting. See the Memory Map section.

³ I_{AVDD} and I_{DRVDD} are measured with a -1 dBFS, 30.3 MHz sine input at rated sample rate.

⁴ Single data rate mode; this is the default mode of the AD9434.

⁵ Double data rate mode; user-programmable feature. See the Memory Map section.

AC SPECIFICATIONS

AVDD = 1.8 V, DRVDD = 1.8 V, T_{MIN} = -40°C, T_{MAX} = +85°C, f_{IN} = -1.0 dBFS, full scale = 1.5 V, unless otherwise noted.

Table 2.

Parameter ^{1,2}	Temp	AD9434-370			AD9434-500			Unit
		Min	Typ	Max	Min	Typ	Max	
SNR								
f _{IN} = 30.3 MHz	25°C		66.3			65.9		dBFS
f _{IN} = 70.3 MHz	25°C		66.2			65.9		dBFS
f _{IN} = 100.3 MHz	25°C		66.1			65.8		dBFS
	Full	65.3			64.5			dBFS
f _{IN} = 250.3 MHz	25°C		65.5			65.2		dBFS
f _{IN} = 450.3 MHz	25°C		64.0			63.5		dBFS
SINAD								
f _{IN} = 30.3 MHz	25°C		66.1			65.9		dBFS
f _{IN} = 70.3 MHz	25°C		66.1			65.8		dBFS
f _{IN} = 100.3 MHz	25°C		66.0			65.8		dBFS
	Full	65.2			64.4			dBFS
f _{IN} = 250.3 MHz	25°C		65.3			64.8		dBFS
f _{IN} = 450.3 MHz	25°C		63.7			62.9		dBFS
EFFECTIVE NUMBER OF BITS (ENOB)								
f _{IN} = 30.3 MHz	25°C		10.7			10.7		Bits
f _{IN} = 70.3 MHz	25°C		10.7			10.6		Bits
f _{IN} = 100.3 MHz	25°C		10.7			10.6		Bits
f _{IN} = 250.3 MHz	25°C		10.6			10.5		Bits
f _{IN} = 450.3 MHz	25°C		10.3			10.2		Bits
WORST HARMONIC (SECOND or THIRD)								
f _{IN} = 30.3 MHz	25°C		-93			-93		dBc
f _{IN} = 70.3 MHz	25°C		-89			-91		dBc
f _{IN} = 100.3 MHz	25°C		-83			-87		dBc
	Full			-75			-74	dBc
f _{IN} = 250.3 MHz	25°C		-80			-78		dBc
f _{IN} = 450.3 MHz	25°C		-78			-69		dBc
SFDR								
f _{IN} = 30.3 MHz	25°C		89			84		dBc
f _{IN} = 70.3 MHz	25°C		88			82		dBc
f _{IN} = 100.3 MHz	25°C		83			83		dBc
	Full	75			74			dBc
f _{IN} = 250.3 MHz	25°C		79			78		dBc
f _{IN} = 450.3 MHz	25°C		78			68		dBc
WORST OTHER HARMONIC (SFDR EXCLUDING SECOND and THIRD)								
f _{IN} = 30.3 MHz	25°C		-90			-85		dBc
f _{IN} = 70.3 MHz	25°C		-90			-82		dBc
f _{IN} = 100.3 MHz	25°C		-91			-84		dBc
	Full			-75			-74	dBc
f _{IN} = 250.3 MHz	25°C		-83			-85		dBc
f _{IN} = 450.3 MHz	25°C		-82			-78		dBc
TWO-TONE IMD								
f _{IN1} = 119.5 MHz, f _{IN2} = 122.5 MHz	25°C		-85			-85		dBc
ANALOG INPUT BANDWIDTH								
Full Power	25°C		1			1		GHz

¹ All ac specifications tested by driving CLK+ and CLK- differentially.

² See the AN-835 Application Note, *Understanding High Speed ADC Testing and Evaluation*, for a complete set of definitions and how these tests were completed.

DIGITAL SPECIFICATIONS

AVDD = 1.8 V, DRVDD = 1.8 V, T_{MIN} = -40°C, T_{MAX} = +85°C, f_{IN} = -1.0 dBFS, full scale = 1.5 V, unless otherwise noted.

Table 3.

Parameter ¹	Temp	AD9434-370			AD9434-500			Unit	
		Min	Typ	Max	Min	Typ	Max		
CLOCK INPUTS									
Logic Compliance	Full	CMOS/LVDS/LVPECL			CMOS/LVDS/LVPECL				
Internal Common-Mode Bias	Full	0.9			0.9			V	
Differential Input Voltage									
High Level Input (V _{IH})	Full	0.2		1.8	0.2		1.8	V p-p	
Low Level Input (V _{IL})	Full	-1.8		-0.2	-1.8		-0.2	V p-p	
High Level Input Current (I _{IH})	Full	-10		+10	-10		+10	μA	
Low Level Input Current (I _{IL})	Full	-10		+10	-10		+10	μA	
Input Resistance (Differential)	Full	8	10	12	8	10	12	kΩ	
Input Capacitance	Full		4			4		pF	
LOGIC INPUTS									
Logic 1 Voltage	Full	0.8 × DRVDD			0.8 × DRVDD			V	
Logic 0 Voltage	Full			0.2 × DRVDD			0.2 × DRVDD	V	
Logic 1 Input Current (SDIO, CSB)	Full		0			0		μA	
Logic 0 Input Current (SDIO, CSB)	Full		-60			-60		μA	
Logic 1 Input Current (SCLK, PDWN)	Full		50			50		μA	
Logic 0 Input Current (SCLK, PDWN)	Full		0			0		μA	
Input Capacitance	25°C		4			4		pF	
LOGIC OUTPUTS²									
V _{OD} Differential Output Voltage	Full	247		454	247		454	mV	
V _{OS} Output Offset Voltage	Full	1.125		1.375	1.125		1.375	V	
Output Coding		Twos complement, Gray code, or offset binary (default)							

¹ See the AN-835 Application Note, *Understanding High Speed ADC Testing and Evaluation*, for a complete set of definitions and how these tests were completed.

² LVDS R_{TERMINATION} = 100 Ω.

SWITCHING SPECIFICATIONS

AVDD = 1.8 V, DRVDD = 1.8 V, T_{MIN} = -40°C, T_{MAX} = +85°C, f_{IN} = -1.0 dBFS, full scale = 1.5 V, unless otherwise noted.

Table 4.

Parameter	Temp	AD9434-370			AD9434-500			Unit
		Min	Typ	Max	Min	Typ	Max	
Maximum Conversion Rate	Full	370			500			MSPS
Minimum Conversion Rate	Full			50			50	MSPS
CLK+ Pulse Width High (t _{CH}) ^{1,2}	Full	1.1		11	0.9		11	ns
CLK+ Pulse Width Low (t _{CL})	Full	1.1		11	0.9		11	ns
Output (LVDS—SDR Mode) ¹								
Data Propagation Delay (t _{PD})	Full		3.55			3.55		ns
Rise Time (t _R) (20% to 80%)	25°C		0.15			0.15		ns
Fall Time (t _F) (20% to 80%)	25°C		0.15			0.15		ns
DCO Propagation Delay (t _{CPD})	Full		3.3			3.3		ns
Data to DCO Skew (t _{SKEW})	Full	0.15		0.38	0.15		0.38	ns
Latency	Full		15			15		Cycles
Output (LVDS—DDR Mode) ²								
Data Propagation Delay (t _{PD})	Full		3.3			3.3		ns
Rise Time (t _R) (20% to 80%)	25°C		0.15			0.15		ns
Fall Time (t _F) (20% to 80%)	25°C		0.15			0.15		ns
DCO Propagation Delay (t _{CPD})	Full		3.3			3.3		ns
Data to DCO Skew (t _{SKEW})	Full	-0.07		+0.07	-0.07		+0.07	ns
Latency	Full		15			15		Cycles
Aperture Time (t _A)	25°C		0.85			0.85		ns
Aperture Uncertainty (Jitter, t _J)	25°C		80			80		fs rms

¹ See Figure 2.² See Figure 3.

Timing Diagrams

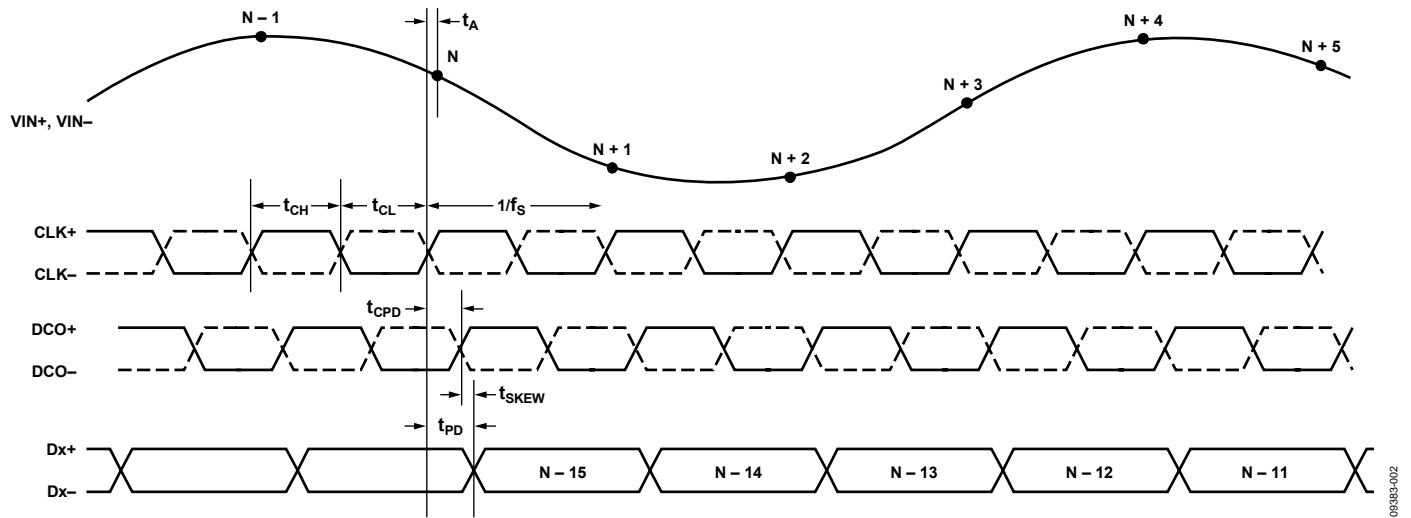

Figure 2. Single Data Rate Mode

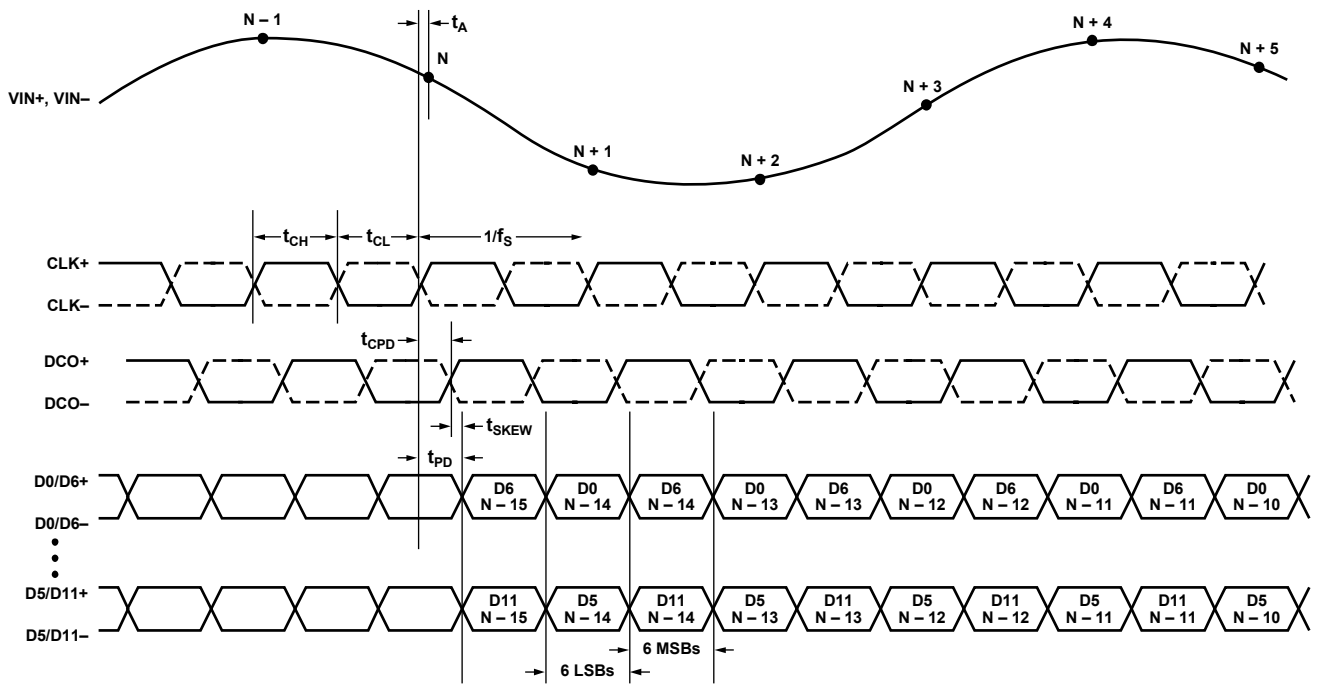

Figure 3. Double Data Rate Mode

ABSOLUTE MAXIMUM RATINGS

Table 5.

Parameter	Rating
Electrical	
AVDD to AGND	−0.3 V to +2.0 V
DRVDD to DRGND	−0.3 V to +2.0 V
AGND to DRGND	−0.3 V to +0.3 V
AVDD to DRVDD	−2.0 V to +2.0 V
D0+/D0− Through D11+/D11− to DRGND	−0.3 V to DRVDD + 0.2 V
DCO+, DCO− to DRGND	−0.3 V to DRVDD + 0.2 V
OR+, OR− to DRGND	−0.3 V to DRVDD + 0.2 V
CLK+ to AGND	−0.3 V to AVDD + 0.2 V
CLK− to AGND	−0.3 V to AVDD + 0.2 V
VIN+ to AGND	−0.3 V to AVDD + 0.4 V
VIN− to AGND	−0.3 V to AVDD + 0.4 V
CML to AGND	−0.3 V to AVDD + 0.2 V
VREF to AGND	−0.3 V to AVDD + 0.2 V
SDIO to DRGND	−0.3 V to DRVDD + 0.2 V
PDWN to AGND	−0.3 V to DRVDD + 0.2 V
CSB to AGND	−0.3 V to DRVDD + 0.2 V
SCLK/DFS to AGND	−0.3 V to DRVDD + 0.2 V
Environmental	
Storage Temperature Range	−65°C to +125°C
Operating Temperature Range	−40°C to +85°C
Lead Temperature (Soldering, 10 sec)	300°C
Junction Temperature	150°C

Stresses above those listed under Absolute Maximum Ratings may cause permanent damage to the device. This is a stress rating only; functional operation of the device at these or any other conditions above those indicated in the operational section of this specification is not implied. Exposure to absolute maximum rating conditions for extended periods may affect device reliability.

THERMAL RESISTANCE

The exposed paddle must be soldered to the ground plane for the LFCSP package. Soldering the exposed paddle to the PCB increases the reliability of the solder joints, maximizing the thermal capability of the package.

Table 6.

Package Type	θ_{JA}	θ_{JC}	Unit
56-Lead LFCSP_VQ (CP-56-5)	23.7	1.7	°C/W

Typical θ_{JA} and θ_{JC} are specified for a 4-layer board in still air. Airflow increases heat dissipation, effectively reducing θ_{JA} . In addition, metal in direct contact with the package leads from metal traces, through holes, ground, and power planes reduces the θ_{JA} .

ESD CAUTION



ESD (electrostatic discharge) sensitive device. Charged devices and circuit boards can discharge without detection. Although this product features patented or proprietary protection circuitry, damage may occur on devices subjected to high energy ESD. Therefore, proper ESD precautions should be taken to avoid performance degradation or loss of functionality.

PIN CONFIGURATIONS AND FUNCTION DESCRIPTIONS

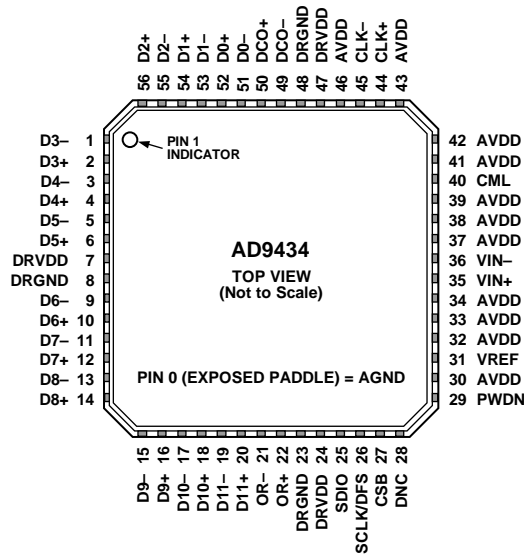

- NOTES**
1. DNC = DO NOT CONNECT. DO NOT CONNECT TO THIS PIN.
 2. AGND AND DRGND SHOULD BE TIED TO A COMMON QUIET GROUND PLANE.
 3. THE EXPOSED PADDLE MUST BE SOLDERED TO A GROUND PLANE.

09389-004

Figure 4. Pin Configuration—Single Data Rate Mode

Table 7. Pin Function Descriptions—Single Data Rate Mode

Pin No.	Mnemonic	Description
0	AGND ¹	Analog Ground. The exposed paddle must be soldered to a ground plane.
30, 32 to 34, 37 to 39, 41 to 43, 46	AVDD	1.8 V Analog Supply.
7, 24, 47	DRVDD	1.8 V Digital Output Supply.
8, 23, 48	DRGND ¹	Digital Output Ground.
35	VIN+	Analog Input—True.
36	VIN-	Analog Input—Complement.
40	CML	Common-Mode Output. Enabled through the SPI, this pin provides a reference for the optimized internal bias voltage for VIN+/VIN-.
44	CLK+	Clock Input—True.
45	CLK-	Clock Input—Complement.
31	VREF	Voltage Reference Internal/Input/Output. Nominally 0.75 V.
28	DNC	Do Not Connect. Do not connect to this pin. This pin should be left floating.
25	SDIO	Serial Port Interface (SPI) Data Input/Output (Serial Port Mode).
26	SCLK/DFS	Serial Port Interface Clock (Serial Port Mode)/Data Format Select (External Pin Mode).
27	CSB	Serial Port Chip Select (Active Low).
29	PWDN	Chip Power-Down.
49	DCO-	Data Clock Output—Complement.
50	DCO+	Data Clock Output—True.
51	D0-	D0 Complement Output (LSB).
52	D0+	D0 True Output (LSB).
53	D1-	D1 Complement Output.
54	D1+	D1 True Output.
55	D2-	D2 Complement Output.
56	D2+	D2 True Output.
1	D3-	D3 Complement Output.
2	D3+	D3 True Output.
3	D4-	D4 Complement Output.

Pin No.	Mnemonic	Description
4	D4+	D4 True Output.
5	D5-	D5 Complement Output.
6	D5+	D5 True Output.
9	D6-	D6 Complement Output.
10	D6+	D6 True Output.
11	D7-	D7 Complement Output.
12	D7+	D7 True Output.
13	D8-	D8 Complement Output.
14	D8+	D8 True Output.
15	D9-	D9 Complement Output.
16	D9+	D9 True Output.
17	D10-	D10 Complement Output.
18	D10+	D10 True Output.
19	D11-	D11 Complement Output (MSB).
20	D11+	D11 True Output (MSB).
21	OR-	Overrange Complement Output.
22	OR+	Overrange True Output.

¹ AGND and DRGND should be tied to a common quiet ground plane.

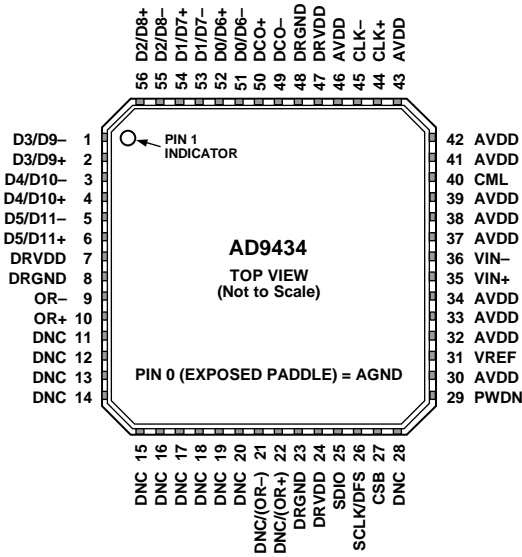

- NOTES**
1. DNC = DO NOT CONNECT. DO NOT CONNECT TO THIS PIN.
 2. AGND AND DRGND SHOULD BE TIED TO A COMMON QUIET GROUND PLANE.
 3. THE EXPOSED PADDLE MUST BE SOLDERED TO A GROUND PLANE.

09383-005

Figure 5. Pin Configuration—Double Data Rate Mode

Table 8. Pin Function Descriptions—Double Data Rate Mode

Pin No.	Mnemonic	Description
0	AGND ¹	Analog Ground. The exposed paddle must be soldered to a ground plane.
30, 32 to 34, 37 to 39, 41 to 43, 46	AVDD	1.8 V Analog Supply.
7, 24, 47	DRVDD	1.8 V Digital Output Supply.
8, 23, 48	DRGND ¹	Digital Output Ground.
35	VIN+	Analog Input—True.
36	VIN-	Analog Input—Complement.
40	CML	Common-Mode Output. Enabled through the SPI, this pin provides a reference for the optimized internal bias voltage for VIN+/VIN-.
44	CLK+	Clock Input—True.
45	CLK-	Clock Input—Complement.
31	VREF	Voltage Reference Internal/Input/Output. Nominally 0.75 V.
25	SDIO	Serial Port Interface (SPI) Data Input/Output (Serial Port Mode).
26	SCLK/DFS	Serial Port Interface Clock (Serial Port Mode)/Data Format Select (External Pin Mode).
27	CSB	Serial Port Chip Select (Active Low).
29	PWDN	Chip Power-Down.
49	DCO-	Data Clock Output—Complement.
50	DCO+	Data Clock Output—True.
51	D0/D6-	D0/D6 Complement Output (LSB).
52	D0/D6+	D0/D6 True Output (LSB).
53	D1/D7-	D1/D7 Complement Output.
54	D1/D7+	D1/D7 True Output.
55	D2/D8-	D2/D8 Complement Output.
56	D2/D8+	D2/D8 True Output.
1	D3/D9-	D3/D9 Complement Output.
2	D3/D9+	D3/D9 True Output.
3	D4/D10-	D4/D10 Complement Output.
4	D4/D10+	D4/D10 True Output.
5	D5/D11-	D5/D11 Complement Output (MSB).

Pin No.	Mnemonic	Description
6	D5/D11+	D5/D11 True Output (MSB).
9	OR-	Overrange Complement Output. (This pin is disabled if Pin 21 is reconfigured through the SPI to be OR-.)
10	OR+	Overrange True Output. (This pin is disabled if Pin 22 is reconfigured through the SPI to be OR+.)
11 to 20, 28	DNC	Do Not Connect. Do not connect to these pins. These pins should be left floating.
21	DNC/(OR-)	Do Not Connect. Do not connect to this pin. (This pin can be reconfigured as the overrange complement output through the serial port register.)
22	DNC/(OR+)	Do Not Connect. Do not connect to this pin. (This pin can be reconfigured as the overrange true output through the serial port register.)

¹ Tie AGND and DRGND to a common quiet ground plane.

TYPICAL PERFORMANCE CHARACTERISTICS

AVDD = 1.8 V, DRVDD = 1.8 V, rated sample rate, T_A = 25°C, 1.5 V p-p differential input, AIN = -1 dBFS, unless otherwise noted.

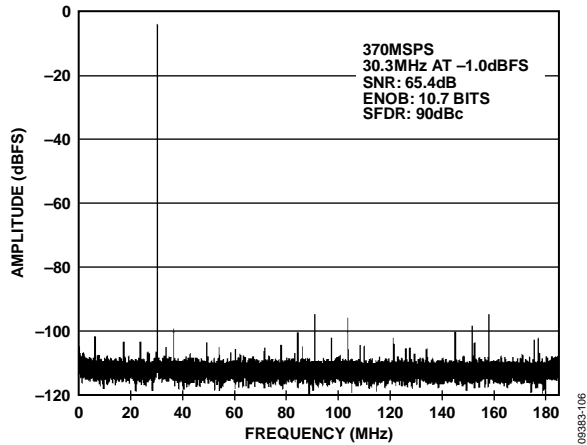

Figure 6. AD9434-370 64k Point Single-Tone FFT; 370 MSPS, 30.3 MHz

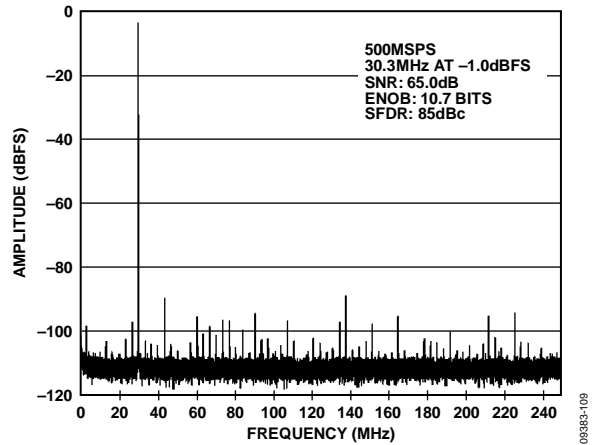

Figure 9. AD9434-500 64k Point Single-Tone FFT; 500 MSPS, 30.3 MHz

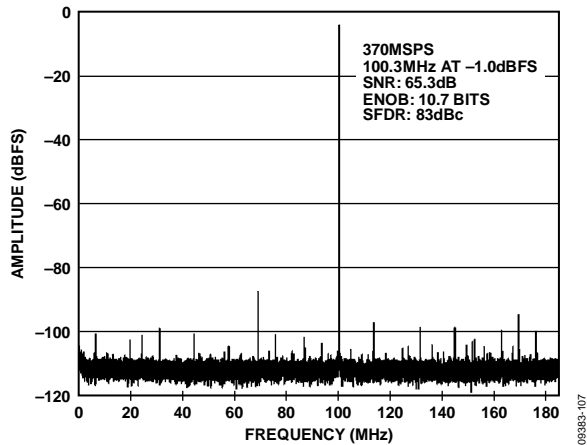

Figure 7. AD9434-370 64k Point Single-Tone FFT; 370 MSPS, 100.3 MHz

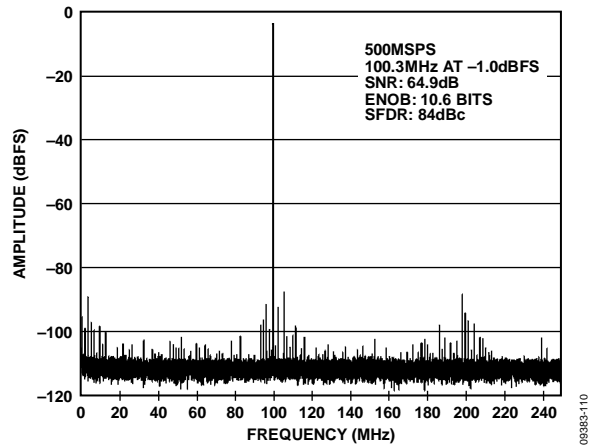

Figure 10. AD9434-500 64k Point Single-Tone FFT; 500 MSPS, 100.3 MHz

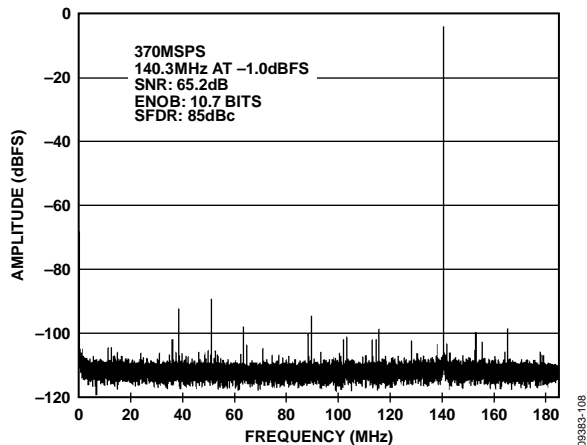

Figure 8. AD9434-370 64k Point Single-Tone FFT; 370 MSPS, 140.3 MHz

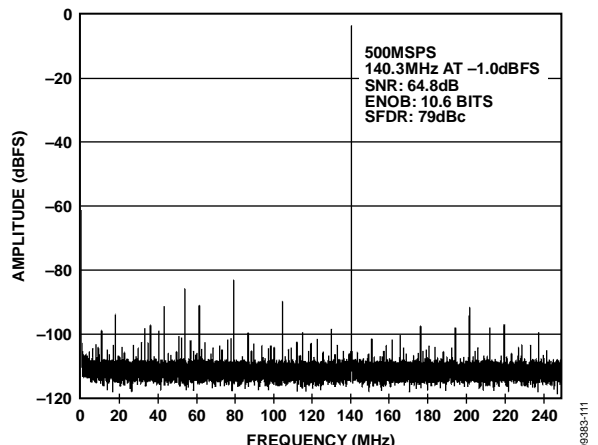

Figure 11. AD9434-500 64k Point Single-Tone FFT; 500 MSPS, 140.3 MHz

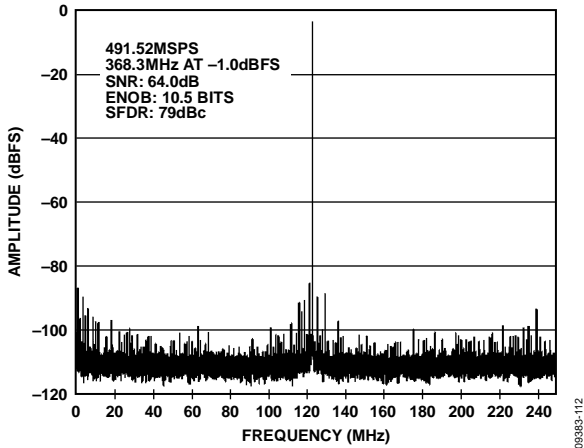

Figure 12. AD9434-500 64k Point Single-Tone; 491.52 MSPS, 368.3 MHz

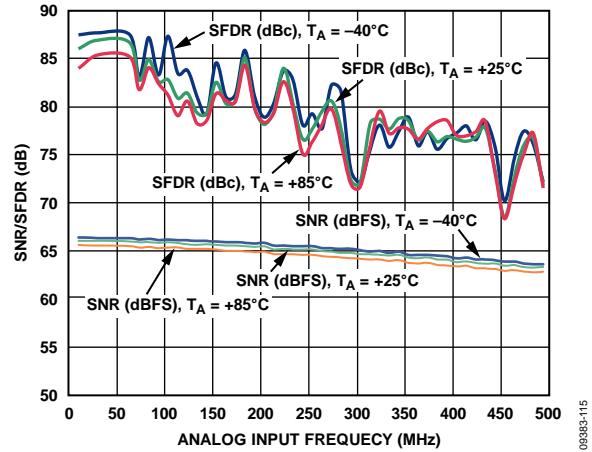

Figure 15. AD9434-500 Single-Tone SNR/SFDR vs. Input Frequency (f_{IN}) and Temperature; 500 MSPS

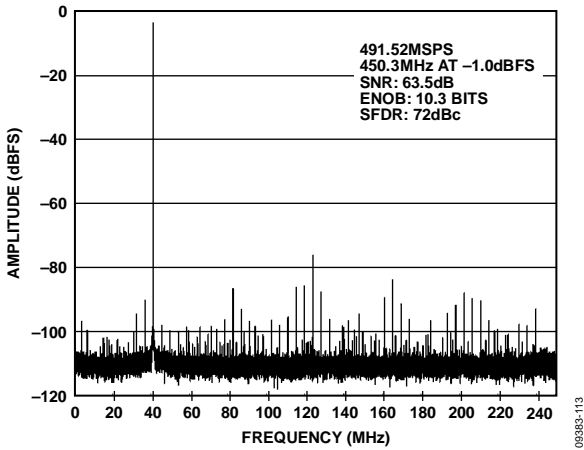

Figure 13. AD9434-500 64k Point Single-Tone; 491.52 MSPS, 450.3 MHz

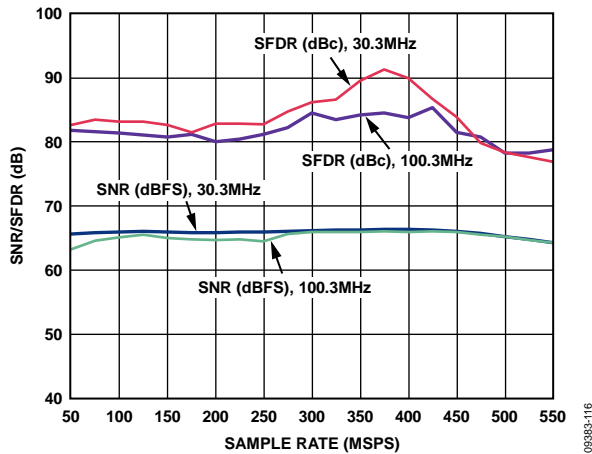

Figure 16. AD9434-370 SNR/SFDR vs. Sample Rate; 30.3 MHz, 100.3 MHz

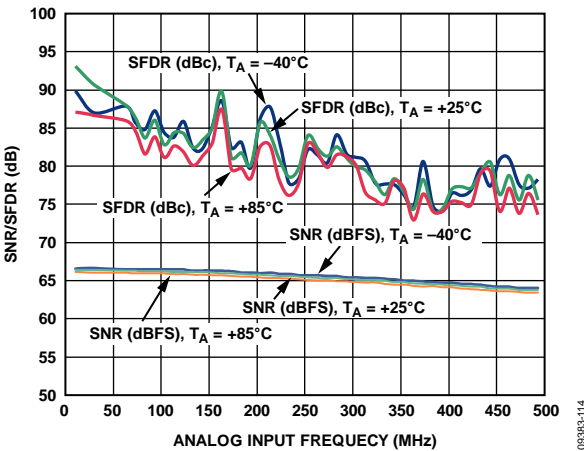

Figure 14. AD9434-370 Single-Tone SNR/SFDR vs. Input Frequency (f_{IN}) and Temperature; 370 MSPS

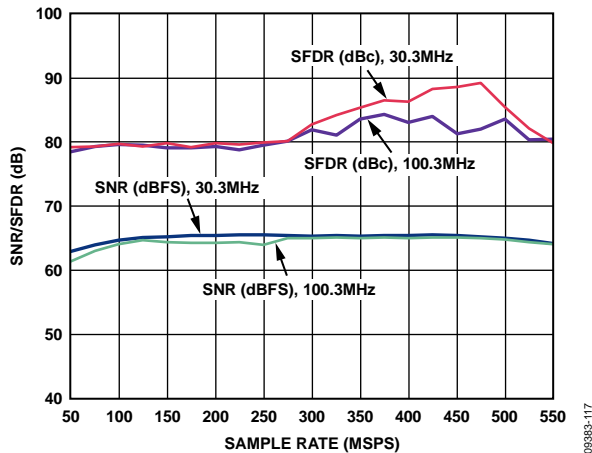

Figure 17. AD9434-500 SNR/SFDR vs. Sample Rate; 30.3 MHz, 100.3 MHz

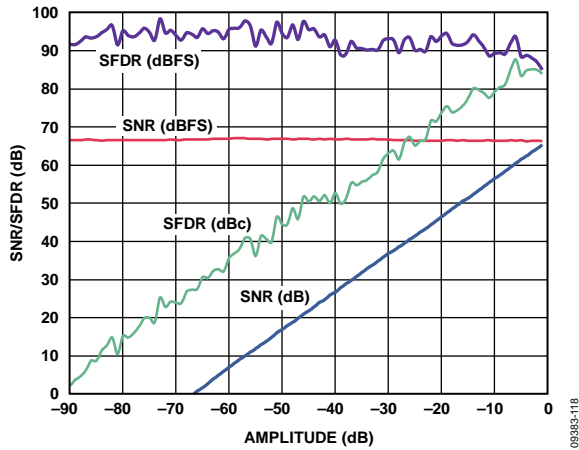

Figure 18. AD9434-370 SNR/SFDR vs. Input Amplitude; 500 MSPS, 140.3 MHz

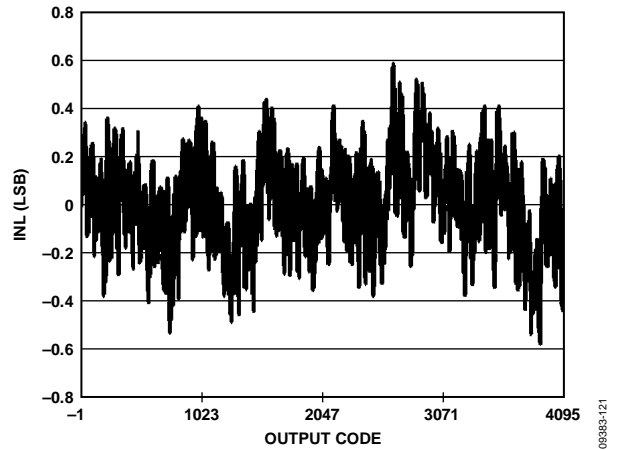

Figure 21. AD9434-500 INL; 500 MSPS

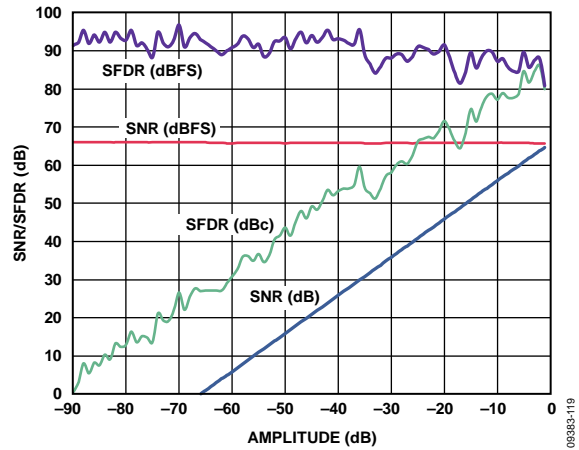

Figure 19. AD9434-500 SNR/SFDR vs. Input Amplitude; 500 MSPS, 140.3 MHz

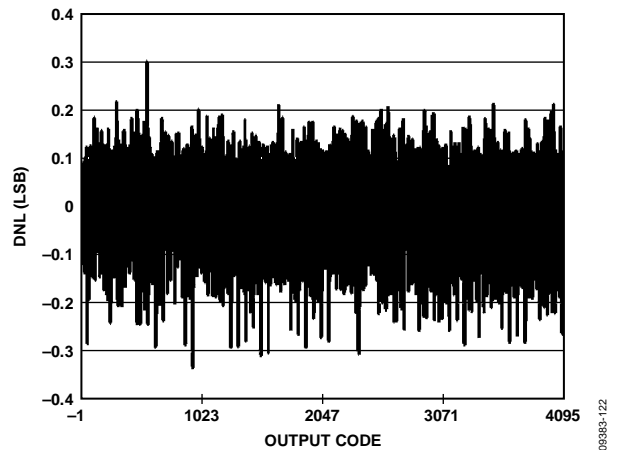

Figure 22. AD9434-370 DNL; 370 MSPS

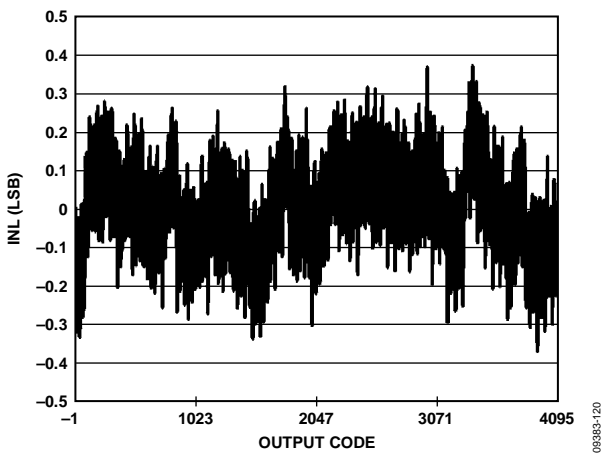

Figure 20. AD9434-370 INL; 370 MSPS

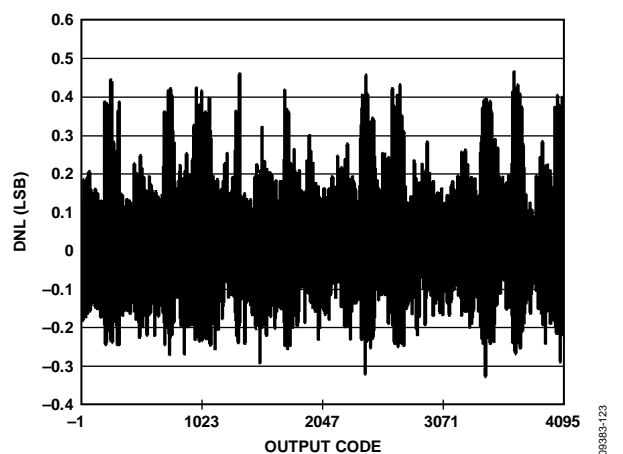

Figure 23. AD9434-500 DNL; 500 MSPS

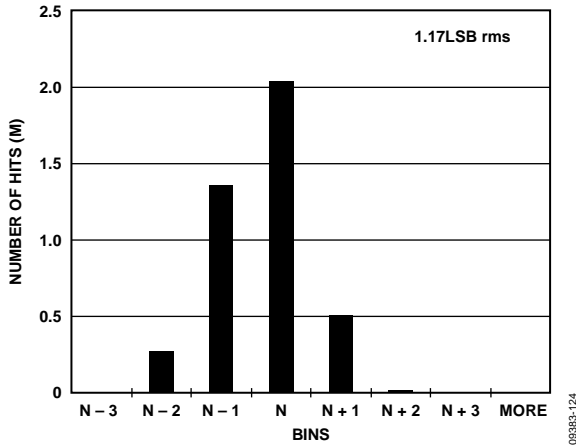

Figure 24. AD9434-370 Grounded Input Histogram; 370 MSPS

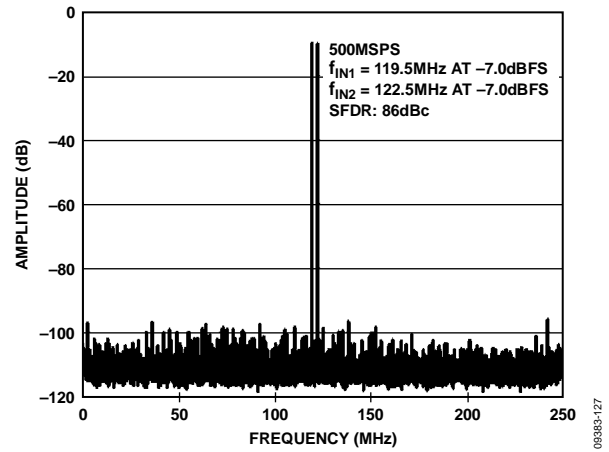

Figure 27. AD9434-500 64k Point, Two-Tone FFT; 500 MSPS, 119.2 MHz, 122.5 MHz

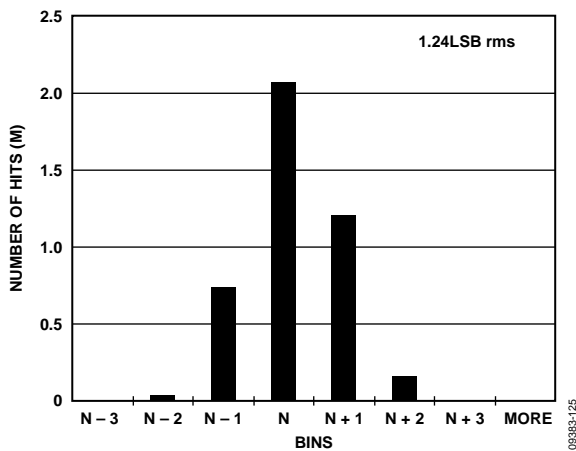

Figure 25. AD9434-500 Grounded Input Histogram; 500 MSPS

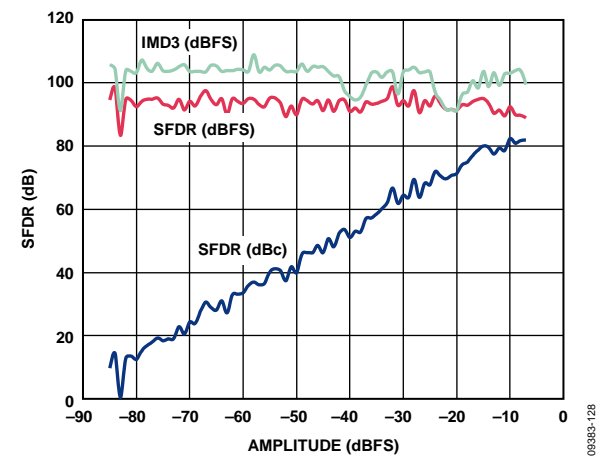

Figure 28. AD9434-370 Two-Tone SFDR vs. Input Amplitude; 370 MSPS, 119.5 MHz, 122.5 MHz

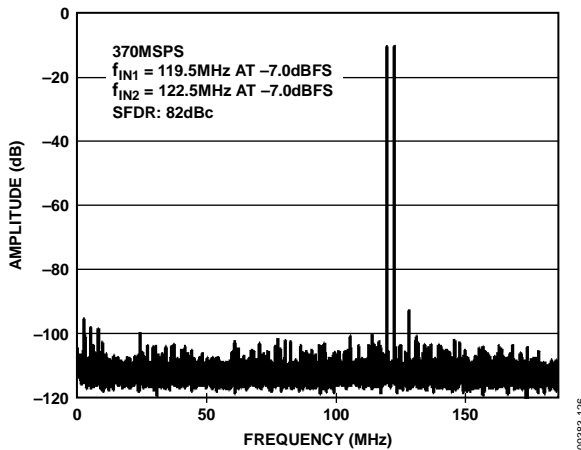

Figure 26. AD9434-370 64k Point, Two-Tone FFT; 370 MSPS, 119.5 MHz, 122.5 MHz

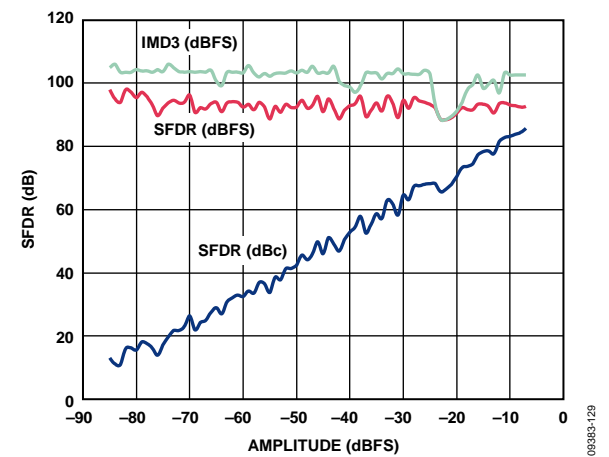

Figure 29. AD9434-500 Two-Tone SFDR vs. Input Amplitude; 500 MSPS, 119.5 MHz, 122.5 MHz

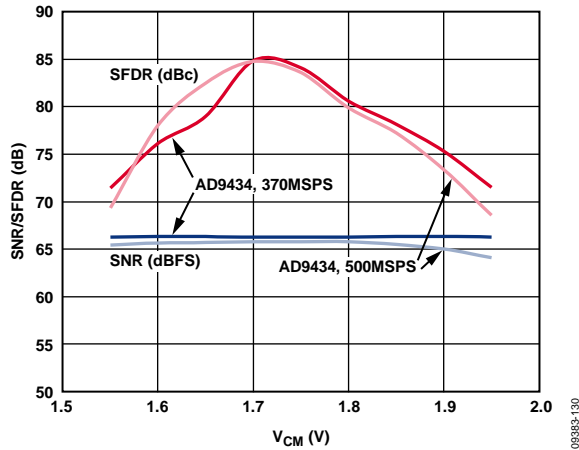

Figure 30. SNR/SFDR vs. Common-Mode Voltage; 370 MSPS, 500 MSPS, $f_{IN} = 140.3$ MHz

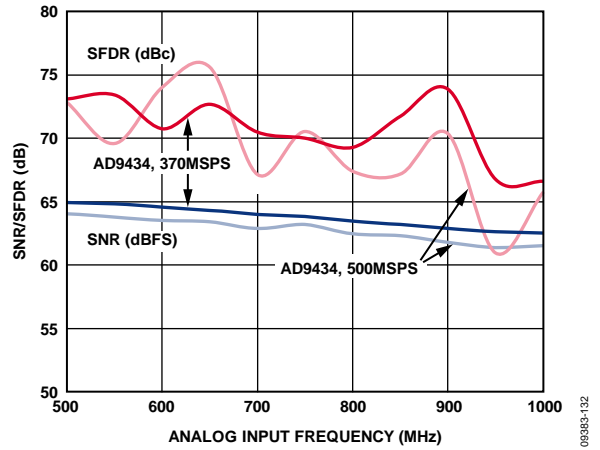

Figure 32. SNR/SFDR for AD9434-370 and AD9434-500 at 370 MSPS and 500 MSPS; AIN Sweep at -1.0 dBFS

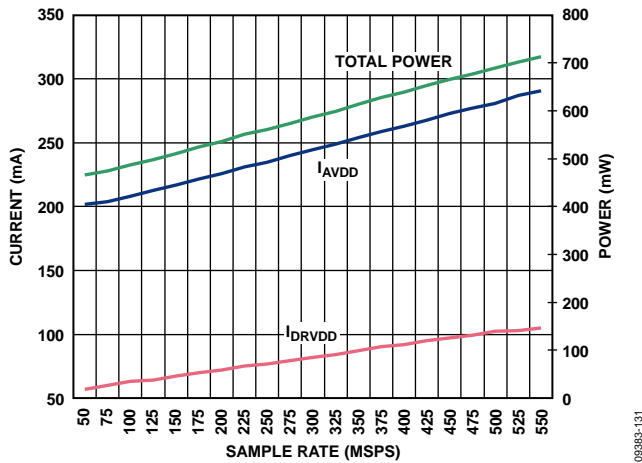

Figure 31. Current and Power vs. Sample Rate, $f_{IN} = 30.3$ MHz

09383-130

09383-132

09383-131

EQUIVALENT CIRCUITS

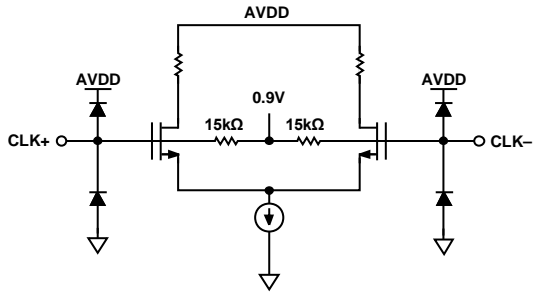

Figure 33. Clock Inputs

09383-006

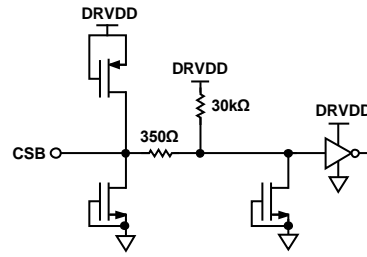

Figure 37. Equivalent CSB Input Circuit

09383-009

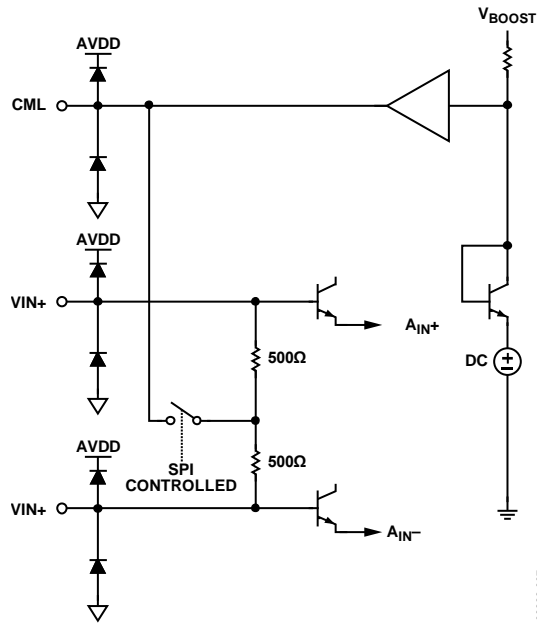

Figure 34. Analog Input DC Equivalent Circuit ($V_{CML} \approx 1.7V$)

09383-007

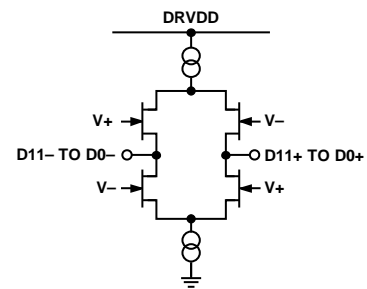

Figure 38. LVDS Outputs ($Dx+$, $Dx-$, $OR+$, $OR-$, $DCO+$, $DCO-$)

09383-010

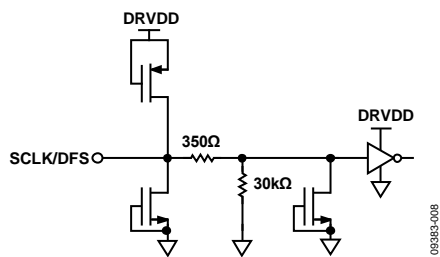

Figure 35. Equivalent SCLK/DFS, PDWN Input Circuit

09383-008

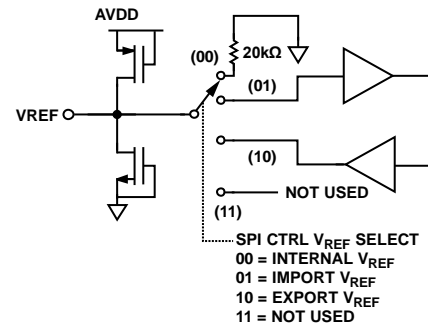

Figure 39. Equivalent VREF Input/Output Circuit

09383-011

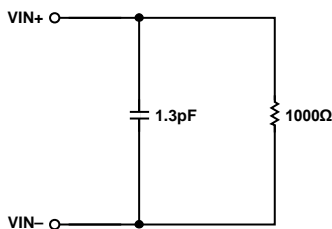

Figure 36. Analog Input AC Equivalent Circuit

09383-025

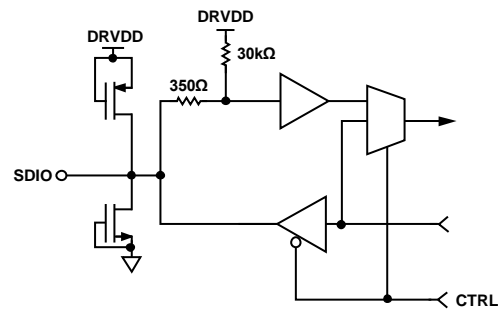

Figure 40. Equivalent SDIO Input Circuit

09383-012

THEORY OF OPERATION

The AD9434 architecture consists of a front-end sample-and-hold amplifier (SHA) followed by a pipelined switched capacitor ADC. The quantized outputs from each stage are combined into a final 12-bit result in the digital correction logic. The pipelined architecture permits the first stage to operate on a new input sample, whereas the remaining stages operate on preceding samples. Sampling occurs on the rising edge of the clock.

Each stage of the pipeline, excluding the last, consists of a low resolution flash ADC connected to a switched capacitor DAC and interstage residue amplifier (MDAC). The residue amplifier magnifies the difference between the reconstructed DAC output and the flash input for the next stage in the pipeline. One bit of redundancy is used in each stage to facilitate digital correction of flash errors. The last stage simply consists of a flash ADC.

The input stage contains a differential SHA that can be ac- or dc-coupled in differential or single-ended mode. The output staging block aligns the data, carries out the error correction, and passes the data to the output buffers. The output buffers are powered from a separate supply, allowing adjustment of the output voltage swing. During power-down, the output buffers enter a high impedance state.

ANALOG INPUT AND VOLTAGE REFERENCE

The analog input to the AD9434 is a differential buffer. For best dynamic performance, match the source impedances driving VIN+ and VIN- such that common-mode settling errors are symmetrical. The analog input is optimized to provide superior wideband performance and requires that the analog inputs be driven differentially. SNR and SINAD performance degrades significantly if the analog input is driven with a single-ended signal.

A wideband transformer, such as Mini-Circuits® ADT1-1WT, can provide the differential analog inputs for applications that require a single-ended-to-differential conversion. Both analog inputs are self-biased by an on-chip reference to a nominal 1.7 V.

An internal differential voltage reference creates positive and negative reference voltages that define the 1.5 V p-p fixed span of the ADC core. This internal voltage reference can be adjusted by means of an SPI control. See the AD9434 Configuration Using the SPI section for more details.

Differential Input Configurations

Optimum performance is achieved while driving the AD9434 in a differential input configuration. For baseband applications, the AD8138 differential driver provides excellent performance and a flexible interface to the ADC. The output common-mode voltage of the AD8138 is easily set to $AVDD/2 + 0.5$ V, and the driver can be configured in a Sallen-Key filter topology to provide band limiting of the input signal.

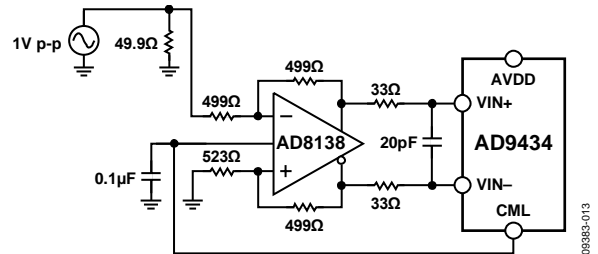

Figure 41. Differential Input Configuration Using the AD8138

At input frequencies in the second Nyquist zone and above, the performance of most amplifiers may not be adequate to achieve the true performance of the AD9434. This is especially true in IF undersampling applications where frequencies in the 70 MHz to 100 MHz range are being sampled. For these applications, differential transformer coupling is the recommended input configuration. The signal characteristics must be considered when selecting a transformer. Most RF transformers saturate at frequencies below a few megahertz (MHz), and excessive signal power can cause core saturation, which leads to distortion.

In any configuration, the value of the shunt capacitor, C (see Figure 43), is dependent on the input frequency and may need to be reduced or removed.

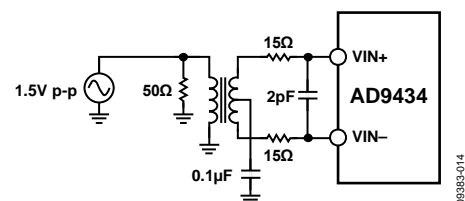

Figure 42. Differential Transformer—Coupled Configuration

As an alternative to using a transformer-coupled input at frequencies in the second Nyquist zone, the AD8352 differential driver can be used (see Figure 43).

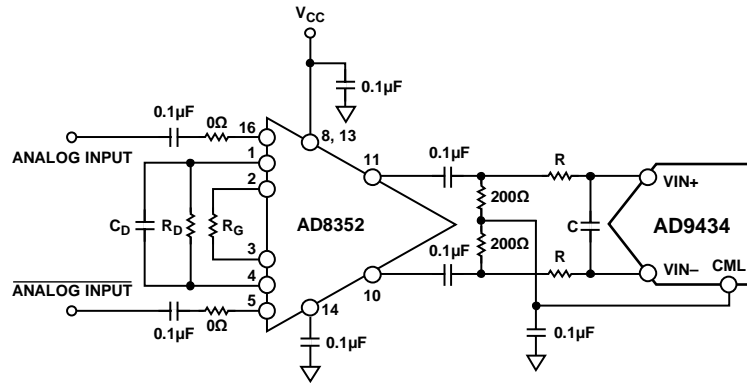

Figure 43. Differential Input Configuration Using the AD8352

CLOCK INPUT CONSIDERATIONS

For optimum performance, drive the AD9434 sample clock inputs (CLK+ and CLK-) with a differential signal. This signal is typically ac-coupled into the CLK+ and CLK- pins via a transformer or capacitors. These pins are biased at ~0.9 V internally and require no additional bias. If the clock signal is dc-coupled, then the common-mode voltage should remain within a range of 0.9 V.

Figure 44 shows one preferred method for clocking the AD9434. The low jitter clock source is converted from single-ended to differential using an RF transformer. The back-to-back Schottky diodes across the secondary transformer limit clock excursions into the AD9434 to approximately 0.8 V p-p differential. This helps prevent the large voltage swings of the clock from feeding through to other portions of the AD9434 and preserves the fast rise and fall times of the signal, which are critical to low jitter performance.

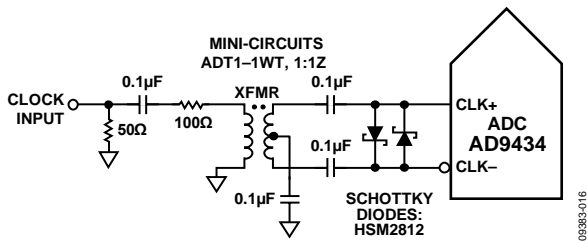
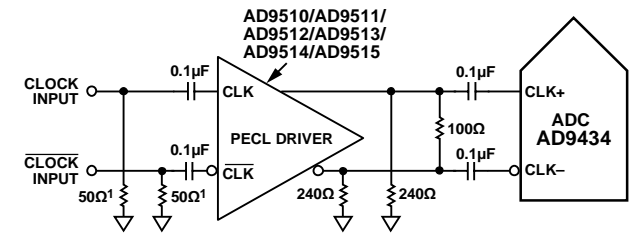

Figure 44. Transformer-Coupled Differential Clock

If a low jitter clock is available, another option is to ac couple a differential PECL signal to the sample clock input pins, as shown in Figure 45. The AD9510/AD9511/AD9512/AD9513/AD9514/AD9515 family of clock drivers offers excellent jitter performance.



150Ω RESISTORS ARE OPTIONAL.

Figure 45. Differential PECL Sample Clock

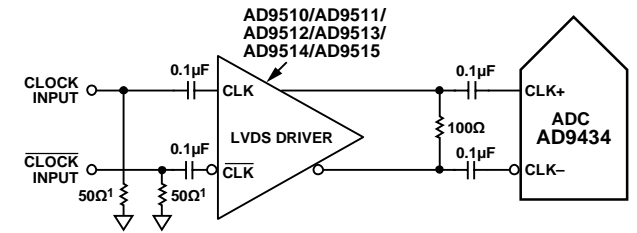

150Ω RESISTORS ARE OPTIONAL.

Figure 46. Differential LVDS Sample Clock

In some applications, it may be acceptable to drive the sample clock inputs with a single-ended 1.8 V CMOS signal. In such applications, drive the CLK+ pin directly from a CMOS gate, and bypass the CLK- pin to ground with a 0.1 µF capacitor in parallel with a 39 kΩ resistor (see Figure 47).

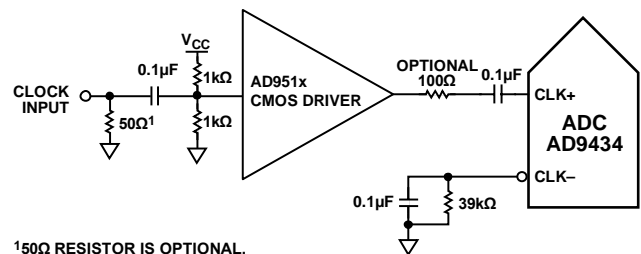

150Ω RESISTOR IS OPTIONAL.

Figure 47. Single-Ended 1.8 V CMOS Input Clock (Up to 200 MHz)

Clock Duty Cycle Considerations

Typical high speed ADCs use both clock edges to generate a variety of internal timing signals. As a result, these ADCs may be sensitive to clock duty cycle. A 5% tolerance is commonly required on the clock duty cycle to maintain dynamic performance characteristics. The AD9434 contains a duty cycle stabilizer (DCS) that retimes the nonsampling edge, providing an internal clock signal with a nominal 50% duty cycle. This allows a wide range of clock input duty cycles without affecting the performance of the AD9434.

The duty cycle stabilizer uses a delay-locked loop (DLL) to create the nonsampling edge. As a result, any changes to the sampling frequency require approximately 5 μ s to allow the DLL to acquire and lock to the new rate.

Clock Jitter Considerations

High speed, high resolution ADCs are sensitive to the quality of the clock input. The degradation in SNR at a given input frequency (f_A) due only to aperture jitter (t_j) can be calculated by

$$SNR \text{ Degradation} = 20 \times \log_{10}(1/2 \times \pi \times f_A \times t_j)$$

In this equation, the rms aperture jitter represents the root mean square of all jitter sources, including the clock input, analog input signal, and ADC aperture jitter specifications. IF undersampling applications are particularly sensitive to jitter (see Figure 48).

Treat the clock input as an analog signal in cases where aperture jitter may affect the dynamic range of the AD9434. Separate power supplies for clock drivers from the ADC output driver supplies to avoid modulating the clock signal with digital noise. Low jitter, crystal-controlled oscillators make the best clock sources. If the clock is generated from another type of source (by gating, dividing, or other methods), it should be retimed by the original clock at the last step.

Refer to the AN-501 Application Note and the AN-756 Application Note for more in-depth information about jitter performance as it relates to ADCs (visit www.analog.com).

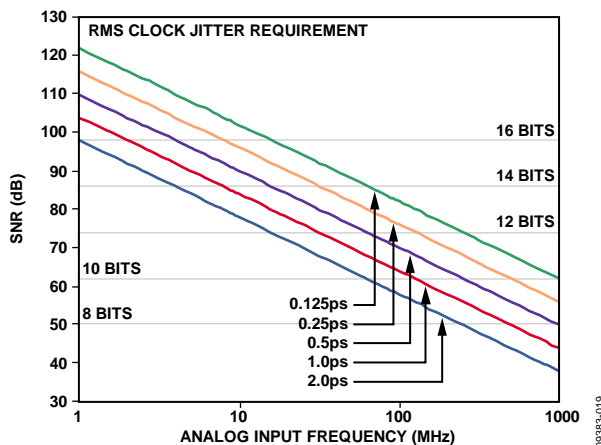

Figure 48. Ideal SNR vs. Input Frequency and Jitter

POWER DISSIPATION AND POWER-DOWN MODE

As shown in Figure 31, the power dissipated by the AD9434 is proportional to its sample rate. The digital power dissipation does not vary much because it is determined primarily by the DRVDD supply and bias current of the LVDS output drivers.

By asserting PDWN (Pin 29) high, the AD9434 is placed in standby mode or full power-down mode, as determined by the contents of Serial Port Register 08. Reasserting the PDWN pin low returns the AD9434 to its normal operational mode.

An additional standby mode is supported by means of varying the clock input. When the clock rate falls below 50 MHz, the AD9434 assumes a standby state. In this case, the biasing network and internal reference remain on, but digital circuitry is powered down. Upon reactivating the clock, the AD9434 resumes normal operation after allowing for the pipeline latency.

DIGITAL OUTPUTS

Digital Outputs and Timing

The AD9434 differential outputs conform to the ANSI-644 LVDS standard on default power-up. This can be changed to a low power, reduced signal option similar to the IEEE 1596.3 standard using the SPI. This LVDS standard can further reduce the overall power dissipation of the device, which reduces the power by ~39 mW. See the Memory Map section for more information. The LVDS driver current is derived on chip and sets the output current at each output equal to a nominal 3.5 mA. A 100 Ω differential termination resistor placed at the LVDS receiver inputs results in a nominal 350 mV swing at the receiver.

The AD9434 LVDS outputs facilitate interfacing with LVDS receivers in custom ASICs and FPGAs that have LVDS capability for superior switching performance in noisy environments. Single point-to-point net topologies are recommended with a 100 Ω termination resistor placed as close to the receiver as possible. No far end receiver termination or poor differential trace routing may result in timing errors. It is recommended that the trace length be no longer than 24 inches and that the differential output traces be kept close together and at equal lengths.

An example of the LVDS output using the ANSI standard (default) data eye and a time interval error (TIE) jitter histogram with trace lengths less than 24 inches on regular FR-4 material is shown in Figure 49. Figure 50 shows an example of when the trace lengths exceed 24 inches on regular FR-4 material. Notice that the TIE jitter histogram reflects the decrease of the data eye opening as the edge deviates from the ideal position. It is up to the user to determine if the waveforms meet the timing budget of the design when the trace lengths exceed 24 inches.

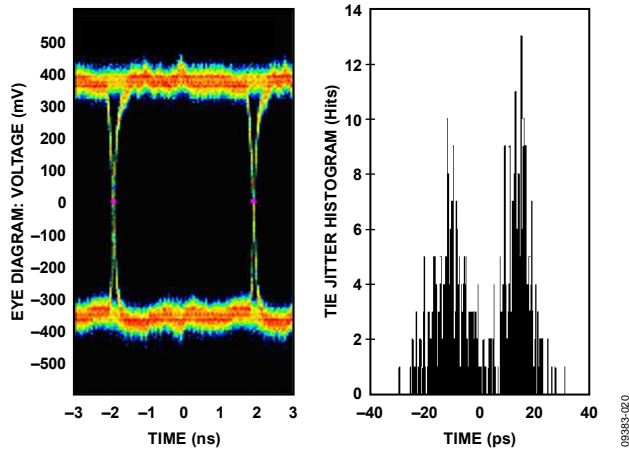

Figure 49. Data Eye for LVDS Outputs in ANSI Mode with Trace Lengths Less than 24 Inches on Standard FR-4, AD9434-500

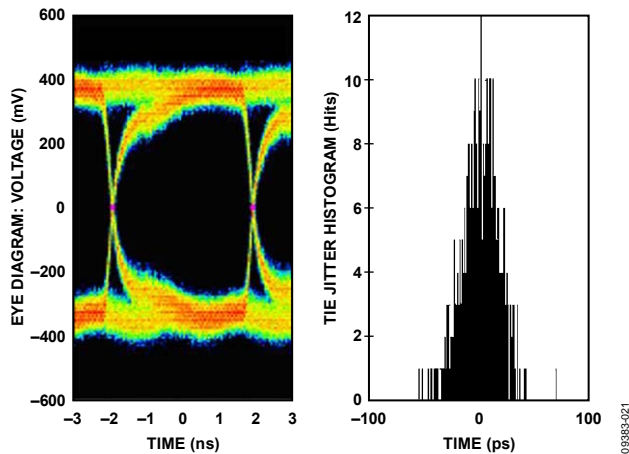

Figure 50. Data Eye for LVDS Outputs in ANSI Mode with Trace Lengths Greater than 24 Inches on Standard FR-4, AD9434-500

The format of the output data is offset binary by default. An example of the output coding format can be found in Table 12. If it is desired to change the output data format to twos complement, see the AD9434 Configuration Using the SPI section.

An output clock signal is provided to assist in capturing data from the AD9434. The DCO is used to clock the output data and is equal to the sampling clock (CLK) rate. In single data rate mode (SDR), data is clocked out of the AD9434 and must be captured on the rising edge of the DCO. In double data rate mode (DDR), data is clocked out of the AD9434 and must be captured on the rising and falling edges of the DCO. See the timing diagrams shown in Figure 2 and Figure 3 for more information.

Output Data Rate and Pinout Configuration

The output data of the AD9434 can be configured to drive 12 pairs of LVDS outputs at the same rate as the input clock signal (SDR mode), or six pairs of LVDS outputs at 2x the rate of the input clock signal (DDR mode). SDR is the default mode; the device can be reconfigured for DDR by setting Bit 3 in Register 14 (see Table 13).

Out-of-Range (OR)

An out-of-range condition exists when the analog input voltage is beyond the input range of the ADC. OR+ and OR- (OR±) are digital outputs that are updated along with the data output corresponding to the particular sampled input voltage. Thus, OR± has the same pipeline latency as the digital data. OR± is low when the analog input voltage is within the analog input range and high when the analog input voltage exceeds the input range, as shown in Figure 51. OR± remains high until the analog input returns to within the input range and another conversion is completed. By logically AND'ing OR± with the MSB and its complement, overrange high or underrange low conditions can be detected.

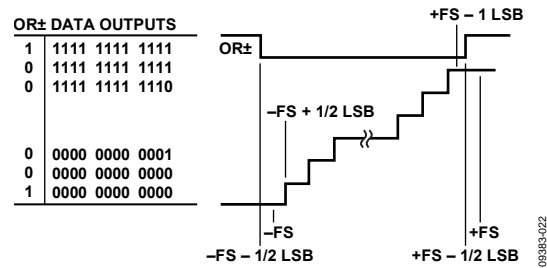

Figure 51. OR± Relation to Input Voltage and Output Data

TIMING

The AD9434 provides latched data outputs with a pipeline delay of seven clock cycles. Data outputs are available one propagation delay (t_{PD}) after the rising edge of the clock signal.

Minimize the length of the output data lines and loads placed on them to reduce transients within the AD9434. These transients can degrade the dynamic performance of the converter. The AD9434 also provides a data clock output (DCO) intended for capturing the data in an external register. The data outputs are valid on the rising edge of DCO.

The lowest conversion rate of the AD9434 is 50 MSPS. At clock rates below 1 MSPS, the AD9434 assumes the standby mode.

VREF

The AD9434 VREF pin (Pin 31) allows the user to monitor the on-board voltage reference, or provide an external reference (requires configuration through the SPI). The three optional settings are internal V_{REF} (pin is connected to 20 kΩ to ground), export V_{REF}, and import V_{REF}. Do not attach a bypass capacitor to this pin. VREF is internally compensated and additional loading may impact performance.

AD9434 CONFIGURATION USING THE SPI

The AD9434 SPI allows the user to configure the converter for specific functions or operations through a structured register space inside the ADC. This gives the user added flexibility to customize device operation depending on the application. Addresses are accessed (programmed or readback) serially in 1-byte words. Each byte can be further divided into fields, which are documented in the Memory Map section.

There are three pins that define the serial port interface (SPI) to this particular ADC. They are the SCLK/DFS, SDIO, and CSB pins. The SCLK/DFS (serial clock) is used to synchronize the read and write data presented to the ADC. The SDIO (serial data input/output) is a dual-purpose pin that allows data to be sent to and read from the internal ADC memory map registers. The CSB is an active low control that enables or disables the read and write cycles (see Table 9).

USING THE AD9434 TO REPLACE THE AD9230

The AD9434 can be used to replace the AD9230 in many applications. In these designs, the user should consider these important differences:

- Pin 28 is a DNC (do not connect) on the AD9434, and should be left floating. The reset functionality of the AD9230 is not available through an external pin, but is available through the SPI interface.
- Pin 31 is the interface to the AD9434 reference circuit. It can be used to monitor the internal reference or provide an external reference voltage (nominally 0.5 V). If the internal reference is used, then this pin can float. The RBIAS function of the AD9230 is not necessary with the AD9434.
- The input voltage range of the AD9434 is nominally 1.5 V p-p, whereas the AD9230 input range is 1.25 V p-p.

Table 9. Serial Port Pins

Mnemonic	Function
SCLK	SCLK (serial clock) is the serial shift clock in. SCLK is used to synchronize serial interface reads and writes.
SDIO	SDIO (serial data input/output) is a dual-purpose pin. The typical role for this pin is an input and output depending on the instruction being sent and the relative position in the timing frame.
CSB	CSB (chip select) is an active low control that gates the read and write cycles.

The falling edge of the CSB, in conjunction with the rising edge of the SCLK, determines the start of the framing. An example of the serial timing and its definitions can be found in Figure 52 and Table 11.

During an instruction phase, a 16-bit instruction is transmitted. Data then follows the instruction phase and is determined by the W0 and W1 bits, which is one or more bytes of data. All

data is composed of 8-bit words. The first bit of each individual byte of serial data indicates whether this is a read or write command. This allows the serial data input/output (SDIO) pin to change direction from an input to an output.

Data can be sent in MSB or in LSB first mode. MSB first is default on power-up and can be changed by changing the configuration register. For more information about this feature and others, see the AN-877 Application Note, *Interfacing to High Speed ADCs via SPI* at www.analog.com.

HARDWARE INTERFACE

The pins described in Table 9 comprise the physical interface between the programming device of the user and the serial port of the AD9434. The SCLK pin and the CSB pin function as inputs when using the SPI interface. The SDIO pin is bidirectional, functioning as an input during the write phase and as an output during readback.

This interface is flexible enough to be controlled by either PROMs or PIC® microcontrollers as well. This provides the user with an alternate method to program the ADC other than a SPI controller.

If the user chooses not to use the SPI interface, some pins serve a dual function and are associated with a specific function when strapped externally to AVDD or ground during device power-on. The Configuration Without the SPI section describes the strappable functions supported on the AD9434.

CONFIGURATION WITHOUT THE SPI

In applications that do not interface to the SPI control registers, the SCLK/DFS pin can alternately serve as a standalone CMOS-compatible control pin. In this mode, connect the CSB pin to AVDD, which disables the serial port interface.

Table 10. Mode Selection

Mnemonic	External Voltage	Configuration
SCLK/DFS	AVDD AGND	Twos complement enabled Offset binary enabled

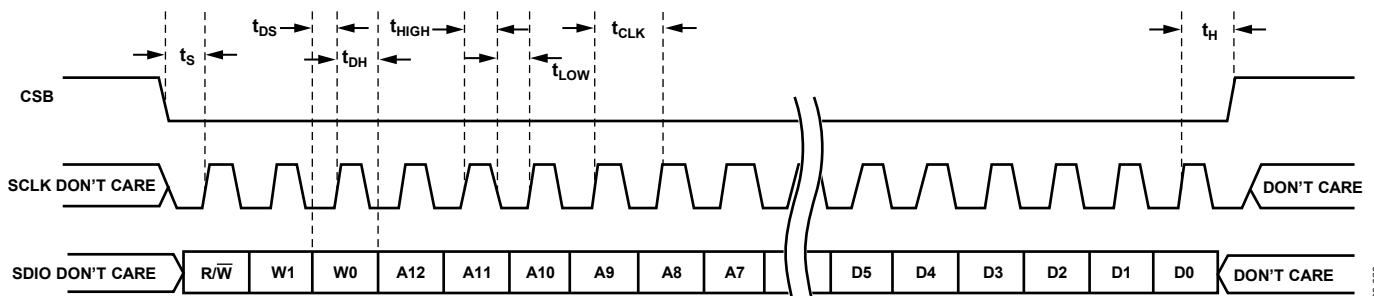

Figure 52. Serial Port Interface Timing Diagram

Table 11. Serial Timing Definitions

Parameter	Min (ns)	Description
t_{DS}	5	Setup time between the data and the rising edge of SCLK
t_{DH}	2	Hold time between the data and the rising edge of SCLK
t_{CLK}	40	Period of the clock
t_S	5	Setup time between CSB and SCLK
t_H	2	Hold time between CSB and SCLK
t_{HIGH}	16	Minimum period that SCLK should be in a logic high state
t_{LOW}	16	Minimum period that SCLK should be in a logic low state
t_{EN_SDIO}	1	Minimum time for the SDIO pin to switch from an input to an output relative to the SCLK falling edge (not shown in Figure 52)
t_{DIS_SDIO}	5	Minimum time for the SDIO pin to switch from an output to an input relative to the SCLK rising edge (not shown in Figure 52)

Table 12. Output Data Format

Input (V)	Condition (V)	Offset Binary Output Mode, D11 to D0	Twos Complement Mode, D11 to D0	OR±
VIN+ – VIN–	< -0.75 – 0.5 LSB	0000 0000 0000	1000 0000 0000	1
VIN+ – VIN–	= -0.75	0000 0000 0000	1000 0000 0000	0
VIN+ – VIN–	= 0	1000 0000 0000	0000 0000 0000	0
VIN+ – VIN–	= 0.75	1111 1111 1111	0111 1111 1111	0
VIN+ – VIN–	> 0.75 + 0.5 LSB	1111 1111 1111	0111 1111 1111	1

MEMORY MAP

READING THE MEMORY MAP TABLE

Each row in the memory map table (see Table 13) has eight address locations. The memory map is roughly divided into three sections: chip configuration register map (Address 0x00 to Address 0x02), transfer register map (Address 0xFF), and ADC functions register map (Address 0x08 to Address 0x2A). Data written to the ADC functions register addresses also require setting the SW transfer bit in register Address 0xFF to transfer the data from the master to slave registers.

The Addr. (Hex) column of the memory map indicates the register address in hexadecimal, and the Default Value (Hex) column shows the default hexadecimal value that is already written into the register. The Bit 7 (MSB) column is the start of the default hexadecimal value given. For example, Hexadecimal Address 0x2A, OVR_CONFIG, has a hexadecimal default value of 0x01. This means that Bit 7 = 0, Bit 6 = 0, Bit 5 = 0, Bit 4 = 0, Bit 3 = 0, Bit 2 = 0, Bit 1 = 0, and Bit 0 = 1, or 0000 0001 in binary. The default value enables the OR± output. Overwriting this default so that Bit 0 = 0 disables the OR± output. For more information on this and other functions, consult the [AN-877](#) Application Note, *Interfacing to High-Speed ADCs via SPI®* at www.analog.com.

RESERVED LOCATIONS

Undefined memory locations should not be written to other than with the default values suggested in this data sheet. Addresses that have values marked as 0 should be considered reserved and have a 0 written into their registers during power-up.

DEFAULT VALUES

Exiting out of reset, critical registers are preloaded with default values. These values are indicated in Table 13. Other registers do not have default values and retain the previous value when exiting reset.

LOGIC LEVELS

An explanation of various registers follows: “Bit is set” is synonymous with “bit is set to Logic 1” or “writing Logic 1 for the bit.” Similarly, “clear a bit” is synonymous with “bit is set to Logic 0” or “writing Logic 0 for the bit.”

Table 13. Memory Map Register

Addr. (Hex)	Register Name	Bit 7 (MSB)	Bit 6	Bit 5	Bit 4	Bit 3	Bit 2	Bit 1	Bit 0 (LSB)	Default Value (Hex)	Default Notes/Comments
Chip Configuration Registers											
00	CHIP_PORT_CONFIG	0	LSB first	Soft reset	1	1	Soft reset	LSB first	0	0x18	The nibbles should be mirrored by the user so that LSB or MSB first mode registers correctly, regardless of shift mode.
01	CHIP_ID	8-bit chip ID, Bits[7:0] = 0x6A								Read only	Default is a unique chip ID, different for each device. This is a read-only register.
02	CHIP_GRADE	0	0	0	Speed grade: 00 = 500 MSPS 01 = 370 MSPS	X ¹	X ¹	X ¹	Read only	Child ID used to differentiate graded devices.	
Transfer Register											
FF	DEVICE_UPDATE	0	0	0	0	0	0	0	SW transfer	0x00	Synchronously transfers data from the master shift register to the slave.
ADC Functions Registers											
08	Modes	0	0	PDWN: 0 = full (default) 1 = standby	0	0	Internal power-down mode: 000 = normal (power-up, default) 001 = full power-down 010 = standby 011 = normal (power-up)	0x00	Determines various generic modes of chip operation.		

Addr. (Hex)	Register Name	Bit 7 (MSB)	Bit 6	Bit 5	Bit 4	Bit 3	Bit 2	Bit 1	Bit 0 (LSB)	Default Value (Hex)	Default Notes/Comments
							Note that external PDWN pin overrides this setting				
10	Offset	8-bit device offset adjustment [7:0] 0111 1111 = +127 codes 0000 0000 = 0 codes 1000 0000 = -128 codes								0x00	Device offset trim: codes are relative to the output resolution.
0D	TEST_IO	(For user-defined mode only, set Bits[3:0] = 1000) 00 = Pattern 1 only 01 = toggle P1/P2 10 = toggle P1/0000 11 = toggle P1/P2/0000	Reset PN23 gen: 1 = on 0 = off (default)	Reset PN9 gen: 1 = on 0 = off (default)	Output test mode: 0000 = off (default) 0001 = midscale short 0010 = +FS short 0011 = -FS short 0100 = checkerboard output 0101 = PN23 sequence 0110 = PN9 0111 = one/zero word toggle 1000 = user defined 1001 = unused 1010 = unused 1011 = unused 1100 = unused (Format determined by OUTPUT_MODE)					0x00	When set, the test data is placed on the output pins in place of normal data. Set pattern values: P1 = Reg 0x19, Reg 0x1A P2 = Reg 0x1B, Reg 0x1C.
0F	AIN_CONFIG	0	0	0	0	0	Analog input disable: 1 = on 0 = off (default)	0	0	0x00	
14	OUTPUT_MODE	0	0	0	Output enable: 0 = enable (default) 1 = disable	DDR: 1 = enabled 0 = disabled (default)	Output invert: 1 = on 0 = off (default)	Data format select: 00 = offset binary (default) 01 = twos complement 10 = Gray code		0x00	
15	OUTPUT_ADJUST	0	0	0	0	LVDS course adjust: 0 = 3.5 mA (default) 1 = 2.0 mA	LVDS fine adjust: 001 = 3.50 mA 010 = 3.25 mA 011 = 3.00 mA 100 = 2.75 mA 101 = 2.50 mA 110 = 2.25 mA 111 = 2.00 mA			0x00	
16	OUTPUT_PHASE	Output clock polarity 1 = inverted 0 = normal (default)	0	0	0	0	0	0	0	0x00	
17	FLEX_OUTPUT_DELAY	0	0	0	0	Output clock delay: 0000 = 0 0001 = -1/10 0010 = -2/10 0011 = -3/10 0100 = reserved 0101 = +5/10 0110 = +4/10 0111 = +3/10 1000 = +2/10 1001 = +1/10				0x00	Shown as fractional value of sampling clock period that is subtracted or added to initial t_{SKW} , see Figure 2

Addr. (Hex)	Register Name	Bit 7 (MSB)	Bit 6	Bit 5	Bit 4	Bit 3	Bit 2	Bit 1	Bit 0 (LSB)	Default Value (Hex)	Default Notes/Comments
18	FLEX_VREF	VREF select 00 = internal V_{REF} (20 k Ω pull-down) 01 = import V_{REF} (0.59 V to 0.8 V on VREF pin) 10 = export V_{REF} (from internal reference) 11 = not used		0	Input voltage range setting: 11100 = 1.60 00101 = 1.36 11101 = 1.58 00110 = 1.34 11110 = 1.55 00111 = 1.31 11111 = 1.52 01000 = 1.28 00000 = 1.50 01001 = 1.26 00001 = 1.47 01010 = 1.23 00010 = 1.44 01011 = 1.20 00011 = 1.42 01100 = 1.18 00100 = 1.39					0x00	
19	USER_PATT1_LSB	B7	B6	B5	B4	B3	B2	B1	B0	0x00	User-defined pattern, 1 LSB.
1A	USER_PATT1_MSB	B7	B6	B5	B4	B3	B2	B1	B0	0x00	User-defined pattern, 1 MSB.
1B	USER_PATT2_LSB	B7	B6	B5	B4	B3	B2	B1	B0	0x00	User-defined pattern, 2 LSBs.
1C	USER_PATT2_MSB	B7	B6	B5	B4	B3	B2	B1	B0	0x00	User-defined pattern, 2 MSBs.
2A	OVR_CONFIG	0	0	0	0	0	0	OR \pm position (DDR mode only): 0 = Pin 9, Pin 10 1 = Pin 21, Pin 22	OR \pm enable: 1 = on (default) 0 = off	0x01	
2C	Input coupling	0	0	0	0	0	DC coupling enable	0	0	0x00	Default is ac coupling.

¹X = don't care.

OUTLINE DIMENSIONS

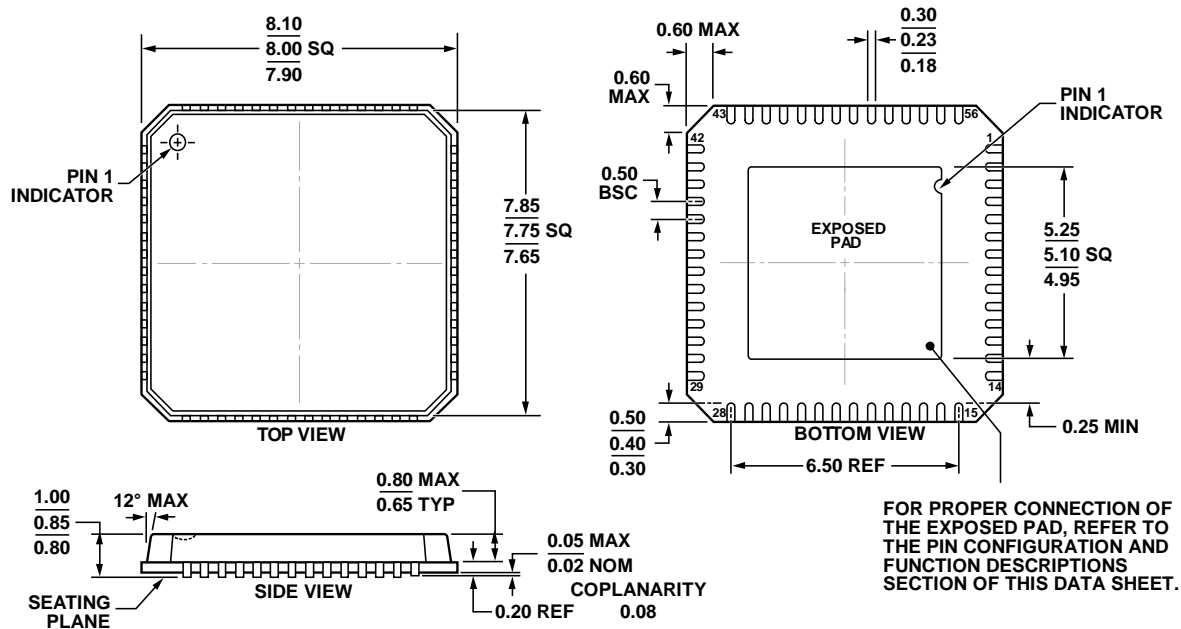

COMPLIANT TO JEDEC STANDARDS MO-220-VLLD-2
 Figure 53. 56-Lead Lead Frame Chip Scale Package [LFCSP_VQ]
 8 mm × 8 mm Body, Very Thin Quad
 (CP-56-5)
 Dimensions shown in millimeters

06-11-2012-A

ORDERING GUIDE

Model ¹	Temperature Range	Package Description	Package Option
AD9434BCPZ-370	-40°C to +85°C	56-Lead Lead Frame Chip Scale Package [LFCSP_VQ]	CP-56-5
AD9434BCPZRL7-370	-40°C to +85°C	56-Lead Lead Frame Chip Scale Package [LFCSP_VQ]	CP-56-5
AD9434BCPZ-500	-40°C to +85°C	56-Lead Lead Frame Chip Scale Package [LFCSP_VQ]	CP-56-5
AD9434BCPZRL7-500	-40°C to +85°C	56-Lead Lead Frame Chip Scale Package [LFCSP_VQ]	CP-56-5
AD9434-370EBZ		LVDS Evaluation Board with AD9434BCPZ-370	
AD9434-500EBZ		LVDS Evaluation Board with AD9434BCPZ-500	

¹ Z = RoHS Compliant Part.