

RECOMMENDED PCB LAYOUT

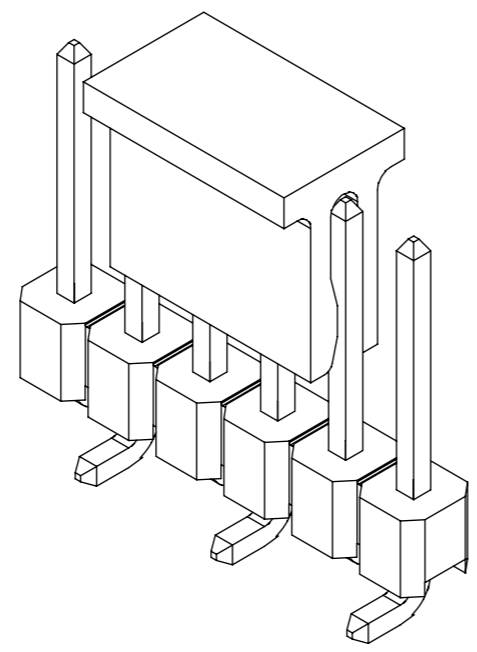
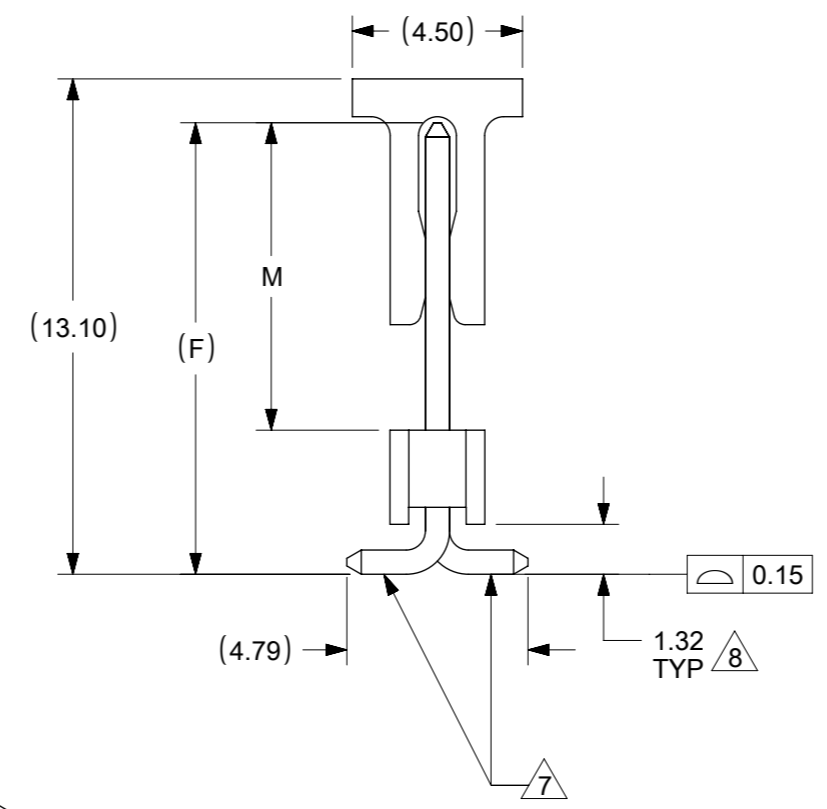
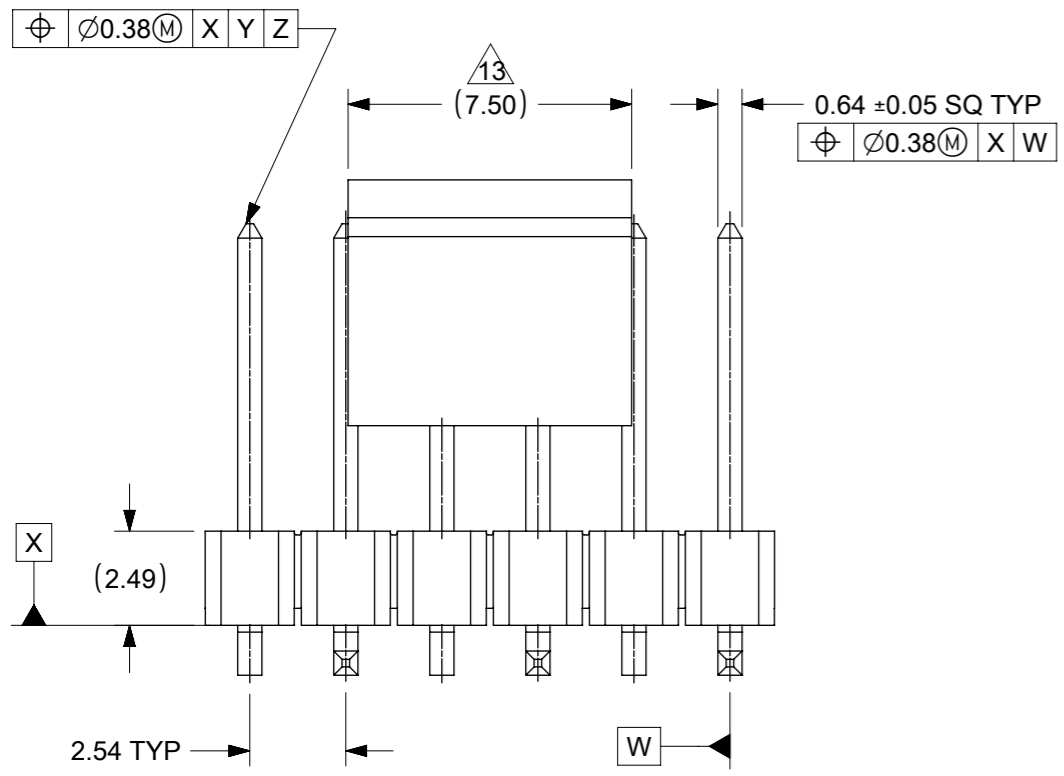

NOTES:

1. MATERIAL:
HSG: NYLON, GLASS-FILLED, UL94V-0, COLOR: BLACK
PIN: 0.64MM SQ, COPPER ALLOY
2. PLATING TYPE:
 - (1) GOLD FLASH OVER
1.25µm MIN. NICKEL OVERALL.
 - (2) GOLD FLASH ON CONTACT AND
2.50µm MIN. TIN ON SOLDER TAIL OVER
1.25µm MIN. NICKEL OVERALL.
 - (4) 0.38µm MIN. GOLD PLATE ON CONTACT AND
2.00µm MIN. TIN ON SOLDER TAIL OVER
1.25µm MIN. NICKEL OVERALL.
 - (5) 0.75µm MIN. GOLD PLATE ON CONTACT AND
2.00µm MIN. TIN ON SOLDER TAIL OVER
1.25µm MIN. NICKEL OVERALL.
 - (6) 2.50µm MIN. TIN OVERALL
1.25µm MIN. NICKEL OVERALL
3. PRODUCT SPECIFICATION: PS-87920-019
4. PACKAGING TYPE: SEE TABLE
5. PACKAGING SPEC: PK-89990-545(TUBE), PK-89990-486(T&R) & PK-87898-400 (T&R)
6. WAFER TO BE FLAT WITHIN 0.003 mm/mm
7. BEND DEPRESSION IS ACCEPTED SO LONG AS IT DOES NOT AFFECT THE OVERALL COPLANARITY OF TAIL
8. COPLANARITY IS TO BE MEASURED BY RESTING THE SOLDER TAIL ON A FLAT SURFACE
9. IRREGULAR CIRCUIT CUTOFF WITHIN BREAKAWAY SECTION IS PERMISSIBLE. CUTTING OR CHIPPING OF THE MAIN BODY IS NOT ACCEPTABLE
10. TUBE LENGTH AS PER STANDARD 560mm
11. RECOMMENDED PCB THICKNESS IS 1.60mm±0.10
12. THE ABOVE CKT 6 IS FOR ILLUSTRATION PURPOSE ONLY
13. CAP LOCATION IS CENTERED ALONG THE MATING ENDS AS SHOWN. TOP SURFACE OF CAP TO BE FLAT FOR THE PURPOSE OF PICK & PLACE BY VACUUM SUCTION NOZZLE.

| | | | | | |
|---|--|----------------------------|--|-------------------------------|--|
| THIS DRAWING CONTAINS INFORMATION THAT IS PROPRIETARY TO MOLEX ELECTRONIC TECHNOLOGIES, LLC AND SHOULD NOT BE USED WITHOUT WRITTEN PERMISSION | | CURRENT REV DESC: | | molex | |
| DIMENSION UNITS: mm | | SCALE: NTS | | | |
| GENERAL TOLERANCES (UNLESS SPECIFIED) | | | | PRODUCT CUSTOMER DRAWING | |
| | | | | DOCUMENT NUMBER: SD-87898-003 | |
| 4 PLACES ± | | MM INCH | | DOC TYPE: PSD | |
| 3 PLACES ± | | | | DOC PART: 001 | |
| 2 PLACES ± 0.2 | | | | REVISION: C1 | |
| 1 PLACE ± | | | | | |
| 0 PLACES ± | | | | | |
| ANGULAR TOL ± 3.0° | | | | | |
| DRAFT WHERE APPLICABLE MUST REMAIN WITHIN DIMENSIONS | | THIRD ANGLE PROJECTION | | SHEET NUMBER: 1 OF 17 | |
| | | DRAWING: A3-SIZE | | SERIES: 87898 | |
| | | MATERIAL NUMBER: SEE TABLE | | CUSTOMER: GENERAL MARKET | |

9 8 7 6 5 4 3 2 1

E
D
C
B
A

PART WITHOUT CAP
IN TUBE
ORIENTATION

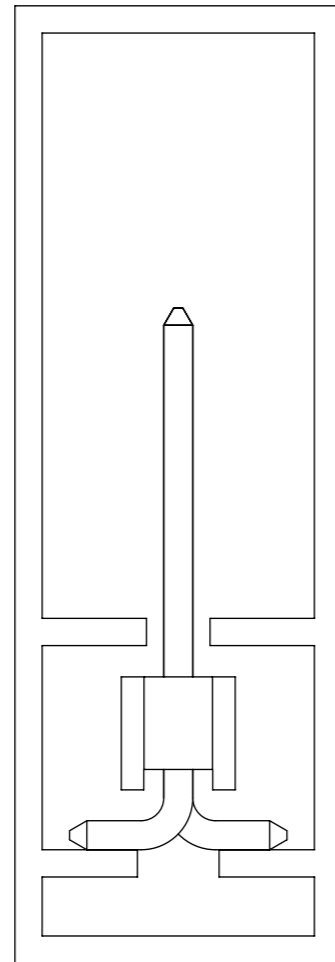

PART WITH CAP
IN TUBE
ORIENTATION

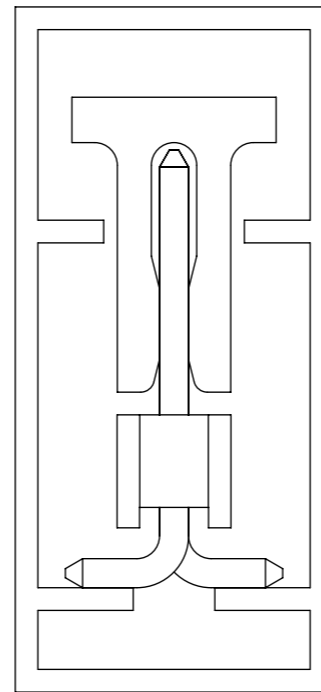

| | | | | | | | | | |
|---|--|------------------------|------|-------------------------------|--|-----------------|--|---|--|
| THIS DRAWING CONTAINS INFORMATION THAT IS PROPRIETARY TO MOLEX ELECTRONIC TECHNOLOGIES, LLC AND SHOULD NOT BE USED WITHOUT WRITTEN PERMISSION | | | | | | | | | |
| DIMENSION UNITS | | SCALE | | CURRENT REV DESC: | | | | molex | |
| mm | | NTS | | | | | | | |
| GENERAL TOLERANCES (UNLESS SPECIFIED) | | | | EC NO: 698212 | | | | CUSTOM HEADER 2.54MM PITCH SINGLE ROW SINGLE WAFER SMT HEADER | |
| | | MM | INCH | DRWN: DANUSA 2022/03/03 | | | | | |
| 4 PLACES | | ± | ± | CHK'D: DANUSA 2022/03/04 | | | | PRODUCT CUSTOMER DRAWING | |
| 3 PLACES | | ± | ± | APPR: MRAMAKRISHNA 2022/03/04 | | | | | |
| 2 PLACES | | ± | 0.2 | INITIAL REVISION: | | | | DOCUMENT NUMBER | |
| 1 PLACE | | ± | ± | DRWN: SKLIM01 2005/10/26 | | | | SD-87898-003 | |
| 0 PLACES | | ± | ± | APPR: PTLIM 2005/11/07 | | | | DOC TYPE DOC PART REVISION | |
| ANGULAR TOL | | ± | 3.0° | DRAWING | | | | PSD 001 C1 | |
| DRAFT WHERE APPLICABLE MUST REMAIN WITHIN DIMENSIONS | | THIRD ANGLE PROJECTION | | SERIES | | MATERIAL NUMBER | | CUSTOMER | |
| | | | | A3-SIZE | | 87898 | | GENERAL MARKET | |
| SHEET NUMBER | | 2 OF 17 | | | | | | | |

| | | | | |
|-----------------|----|--------------|------------|----------|
| DOCUMENT STATUS | P1 | RELEASE DATE | 2022/03/04 | 09:00:56 |
|-----------------|----|--------------|------------|----------|

9 8 7 6 5 4 3 2 1

FORMAT: Mef-lega-master-ib-prod-A3
REVISION: D
DATE: 2018/01/18

| CKT | DIMENSION | | | | | | QTY/REEL |
|-----|-----------|------|-------|-------|-------|-------|----------|
| | Bo | Ao | Ko | F | So | W | |
| 3 | 8.02 | 5.20 | 13.60 | 11.50 | -- | 24.00 | 320 |
| 4 | 10.51 | 5.79 | 15.05 | 14.20 | 28.40 | 32.00 | 250 |
| 5 | 13.10 | 5.20 | 13.60 | 11.50 | --- | 24.00 | 320 |

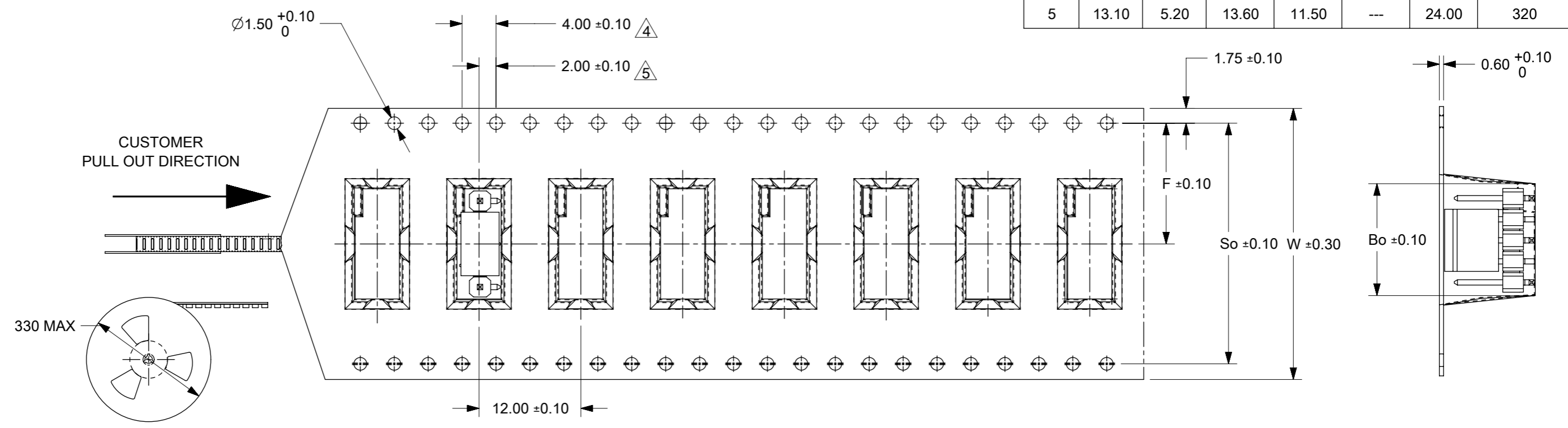

NOTES:

1. LEADER AND TRAILER TAPE

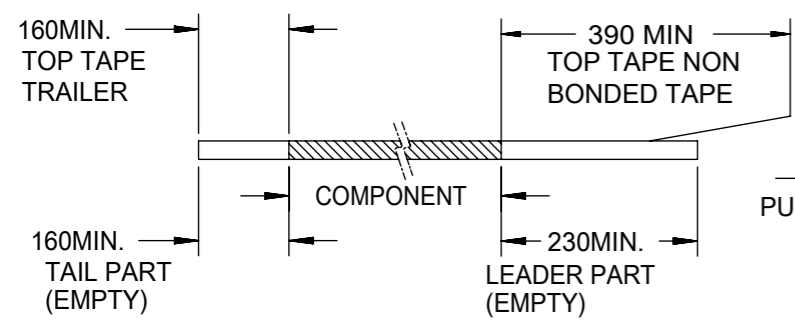

2. PEELING OFF FORCE OF THE TOP TAPE: 20 - 80gf. (PEELING DIRECTION AS SHOWN IN FOLLOWING FIGURE)

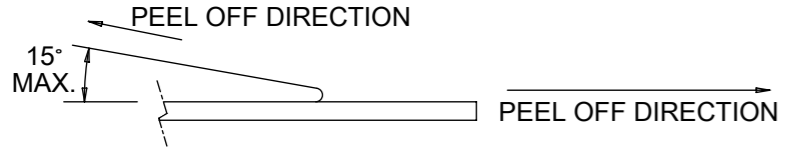

- 3. MATERIAL: BLACK P.S CONDUCTIVE, BLACK
- 4. MEASURED FROM CENTRELINE OF SPROCKET HOLE TO CENTRELINE OF POCKET
- 5. CUMULATIVE TOLERANCE OF 10 SPROCKET HOLE IS $\pm 0.20\text{mm}$
- 6. A0 AND B0 ARE MEASURE FROM ABOVE POCKET BASE 0.30mm
- 7. TAPE AND REEL SPECIFICATION IS AS PER EIA-481.
- 8. THE TAPE IS TREATED FOR ANTI-STATIC.
- 9. ALL RADIUS ARE 0.30MM UNLESS SPECIFY
- 10. SURFACE RESISTIVITY 10^3 TO 10 OHMS.

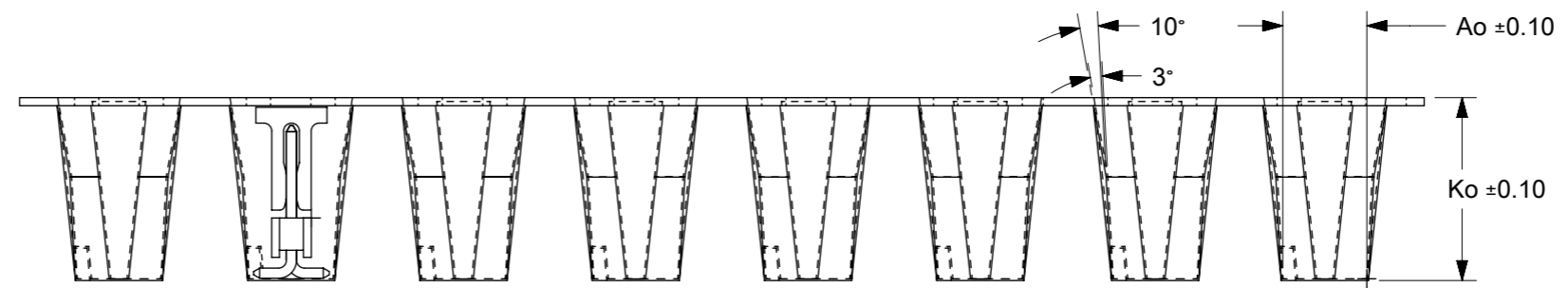

PART PACK IN E/TAPE ORIENTATION (FOR REF USE)

THIS DRAWING CONTAINS INFORMATION THAT IS PROPRIETARY TO MOLEX ELECTRONIC TECHNOLOGIES, LLC AND SHOULD NOT BE USED WITHOUT WRITTEN PERMISSION

| | | | | | | |
|--|-----------------|------------------------|------------|---|-----------------|----------------|
| DIMENSION UNITS | SCALE | CURRENT REV DESC: | | molex | | |
| mm | NTS | | | | | |
| GENERAL TOLERANCES (UNLESS SPECIFIED) | | EC NO: 698212 | | CUSTOMER | | |
| 4 PLACES | \pm | DRWN: DANUSA | 2022/03/03 | 2.54MM PITCH SINGLE ROW SINGLE WAFER SMT HEADER | | |
| 3 PLACES | \pm | CHK'D: DANUSA | 2022/03/04 | PRODUCT CUSTOMER DRAWING | | |
| 2 PLACES | ± 0.2 | APPR: MRAMAKRISHNA | 2022/03/04 | DOCUMENT NUMBER | | |
| 1 PLACE | \pm | INITIAL REVISION: | | SD-87898-003 | | |
| 0 PLACES | \pm | DRWN: SKLIM01 | 2005/10/26 | DOC TYPE | DOC PART | REVISION |
| ANGULAR TOL | $\pm 3.0^\circ$ | APPR: PTLIM | 2005/11/07 | PSD | 001 | C1 |
| DRAFT WHERE APPLICABLE MUST REMAIN WITHIN DIMENSIONS | | THIRD ANGLE PROJECTION | DRAWING | SERIES | MATERIAL NUMBER | CUSTOMER |
| | | | A3-SIZE | 87898 | SEE TABLE | GENERAL MARKET |
| | | | | | | SHEET NUMBER |
| | | | | | | 3 OF 17 |

9 8 7 6 5 4 3 2 1

| PACKAGING OPTION PART NO. | | | | | | CKT SIZE | VOID POSITION | PLATING TYPE | DIMENSION | | | |
|---------------------------|----------------|------------------|---------------|-------------------------|----------------------|----------|---------------|--------------|-----------|------|-------|------|
| TRAY WITHOUT CAP | TRAY WITH CAP | TUBE WITHOUT CAP | TUBE WITH CAP | TAPE & REEL WITHOUT CAP | TAPE & REEL WITH CAP | | | | A | B | F | M |
| ----- | (C) 87898-0361 | ----- | ----- | ----- | ----- | 3 | ---- | 1 | 7.62 | 5.08 | 11.94 | 8.13 |
| ----- | (C) 87898-0362 | ----- | ----- | ----- | ----- | 3 | ---- | 2 | 7.62 | 5.08 | 11.94 | 8.13 |
| ----- | (C) 87898-0364 | ----- | ----- | ----- | 87898-0369 | 3 | ---- | 4 | 7.62 | 5.08 | 11.94 | 8.13 |
| ----- | (C) 87898-0365 | ----- | ----- | ----- | ----- | 3 | ---- | 5 | 7.62 | 5.08 | 11.94 | 8.13 |
| ----- | (C) 87898-0366 | ----- | 87898-0367 | ----- | 87898-0368 | 3 | ---- | 6 | 7.62 | 5.08 | 11.94 | 8.13 |

E

E

D

D

C

C

B

B

A

A

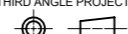
| | | | | | | | | | | | | | |
|---|---|-------|--------------|---|--|----------|--|-----------------|--|---|--|--|--|
| THIS DRAWING CONTAINS INFORMATION THAT IS PROPRIETARY TO MOLEX ELECTRONIC TECHNOLOGIES, LLC AND SHOULD NOT BE USED WITHOUT WRITTEN PERMISSION | | | | | | | | | | | | | |
| DIMENSION UNITS | | SCALE | | CURRENT REV DESC: | | | | | |  | | | |
| mm | | NTS | | | | | | | | | | | |
| GENERAL TOLERANCES (UNLESS SPECIFIED) | | | | EC NO: 698212 DRWN: DANUSA 2022/03/03 CHK'D: DANUSA 2022/03/04 APPR: MRAMAKRISHNA 2022/03/04 | | | | | | CUSTOM HEADER 2.54MM PITCH SINGLE ROW SINGLE WAFER SMT HEADER | | | |
| | | MM | INCH | | | | | | | | | | |
| 4 PLACES | ± | | ± | INITIAL REVISION: DRWN: SKLIM01 2005/10/26 APPR: PTLIM 2005/11/07 | | | | | | PRODUCT CUSTOMER DRAWING DOCUMENT NUMBER: SD-87898-003 DOC TYPE: PSD DOC PART: 001 REVISION: C1 | | | |
| 3 PLACES | ± | | ± | | | | | | | | | | |
| 2 PLACES | ± | 0.2 | ± | DRAFT WHERE APPLICABLE MUST REMAIN WITHIN DIMENSIONS | | | | | | THIRD ANGLE PROJECTION  | | | |
| 1 PLACE | ± | | ± | | | | | | | | | | |
| 0 PLACES | ± | | ± | DRAWING | | SERIES | | MATERIAL NUMBER | | CUSTOMER | | | |
| ANGULAR TOL ± 3.0° | | | | A3-SIZE | | 87898 | | SEE TABLE | | GENERAL MARKET | | | |
| DOCUMENT STATUS | | P1 | RELEASE DATE | 2022/03/04 | | 09:00:56 | | SHEET NUMBER | | 4 OF 17 | | | |

DOCUMENT STATUS P1 RELEASE DATE 2022/03/04 09:00:56

9 8 7 6 5 4 3 2 1

FORMAT: Mel-lega-master-ib-prod-A3
 REVISION: D
 DATE: 2018/01/18

| PACKAGING OPTION PART NO. | | | | | | CKT SIZE | PEG | VOID POSITION | PLATING TYPE | DIMENSION | | | |
|---------------------------|---------------|------------------|---------------|-------------------------|----------------------|----------|-----|---------------|--------------|-----------|-------|-------|-------|
| TRAY WITHOUT CAP | TRAY WITH CAP | TUBE WITHOUT CAP | TUBE WITH CAP | TAPE & REEL WITHOUT CAP | TAPE & REEL WITH CAP | | | | | A | B | F | M |
| ----- | ----- | 87898-0461 | ----- | ----- | ----- | 4 | --- | ---- | 1 | 10.16 | 7.62 | 11.94 | 8.13 |
| ----- | ----- | 87898-0462 | ----- | ----- | ----- | 4 | --- | ---- | 2 | 10.16 | 7.62 | 11.94 | 8.13 |
| ----- | ----- | 87898-0464 | ----- | ----- | ----- | 4 | --- | ---- | 4 | 10.16 | 7.62 | 11.94 | 8.13 |
| ----- | ----- | 87898-0465 | ----- | ----- | ----- | 4 | --- | ---- | 5 | 10.16 | 7.62 | 11.94 | 8.13 |
| ----- | ----- | 87898-0466 | ----- | ----- | 87898-0467 | 4 | --- | ---- | 6 | 10.16 | 7.62 | 11.94 | 8.13 |
| ----- | ----- | ----- | ----- | ----- | 87898-0468 | 4 | Y | ---- | 6 | 10.16 | 7.62 | 11.94 | 8.13 |
| ----- | ----- | ----- | ----- | 87898-0489 | ----- | 4 | Y | ---- | 5 | 10.16 | 7.62 | 16.74 | 12.93 |
| ----- | ----- | 87898-0561 | ----- | ----- | ----- | 5 | --- | ---- | 1 | 12.70 | 10.16 | 11.94 | 8.13 |
| ----- | ----- | 87898-0562 | ----- | ----- | ----- | 5 | --- | ---- | 2 | 12.70 | 10.16 | 11.94 | 8.13 |
| ----- | ----- | 87898-0564 | ----- | ----- | ----- | 5 | --- | ---- | 4 | 12.70 | 10.16 | 11.94 | 8.13 |
| ----- | ----- | 87898-0565 | ----- | ----- | ----- | 5 | --- | ---- | 5 | 12.70 | 10.16 | 11.94 | 8.13 |
| ----- | ----- | 87898-0566 | 87898-0567 | ----- | 87898-0568 | 5 | --- | ---- | 6 | 12.70 | 10.16 | 11.94 | 8.13 |
| ----- | ----- | 87898-0661 | ----- | ----- | ----- | 6 | --- | ---- | 1 | 15.24 | 12.70 | 11.94 | 8.13 |
| ----- | ----- | 87898-0662 | ----- | ----- | ----- | 6 | --- | ---- | 2 | 15.24 | 12.70 | 11.94 | 8.13 |
| ----- | ----- | 87898-0664 | ----- | ----- | ----- | 6 | --- | ---- | 4 | 15.24 | 12.70 | 11.94 | 8.13 |
| ----- | ----- | 87898-0665 | ----- | ----- | (C) ----- | 6 | --- | ---- | 5 | 15.24 | 12.70 | 11.94 | 8.13 |
| ----- | ----- | 87898-0666 | ----- | ----- | 87898-0605 | 6 | --- | ---- | 6 | 15.24 | 12.70 | 11.94 | 8.13 |

4 CKT WITH PEG FOR ILLUSTRATION ONLY

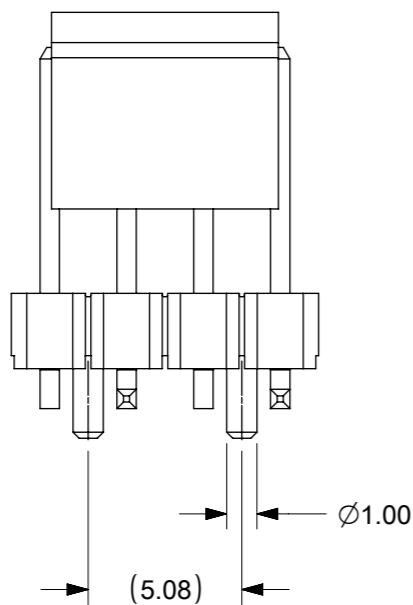

| | | | | | | | | | | | |
|---|--|-------|--|--|--|------------------------|--|--------------------------|--|--|--|
| THIS DRAWING CONTAINS INFORMATION THAT IS PROPRIETARY TO MOLEX ELECTRONIC TECHNOLOGIES, LLC AND SHOULD NOT BE USED WITHOUT WRITTEN PERMISSION | | | | | | | | | | | |
| DIMENSION UNITS | | SCALE | | CURRENT REV DESC: | | | | | | | |
| mm | | NTS | | | | | | | | | |
| GENERAL TOLERANCES (UNLESS SPECIFIED) | | | | EC NO: 698212 | | DRWN: DANUSA | | 2022/03/03 | | CUSTOM HEADER 2.54MM PITCH SINGLE ROW SINGLE WAFER SMT HEADER | |
| | | | | CHK'D: DANUSA | | 2022/03/04 | | | | | |
| | | | | APPR: MRAMAKRISHNA | | 2022/03/04 | | PRODUCT CUSTOMER DRAWING | | | |
| 4 PLACES ± | | | | INITIAL REVISION: | | DRWN: SKLIM01 | | 2005/10/26 | | DOCUMENT NUMBER | |
| 3 PLACES ± | | | | APPR: PTLIM | | 2005/11/07 | | SD-87898-003 | | DOC TYPE DOC PART REVISION | |
| 2 PLACES ± 0.2 | | | | DRAFT WHERE APPLICABLE MUST REMAIN WITHIN DIMENSIONS | | THIRD ANGLE PROJECTION | | DRAWING | | SHEET NUMBER | |
| 1 PLACE ± | | | | A3-SIZE | | SERIES | | 87898 | | MATERIAL NUMBER CUSTOMER | |
| 0 PLACES ± | | | | SEE TABLE | | GENERAL MARKET | | 5 OF 17 | | | |
| ANGULAR TOL ± 3.0° | | | | | | | | | | | |

| PACKAGING OPTION PART NO. | | | | | | CKT SIZE | VOID POSITION | PLATING TYPE | DIMENSION | | | |
|---------------------------|---------------|------------------|---------------|-------------------------|----------------------|----------|---------------|--------------|-----------|-------|-------|------|
| TRAY WITHOUT CAP | TRAY WITH CAP | TUBE WITHOUT CAP | TUBE WITH CAP | TAPE & REEL WITHOUT CAP | TAPE & REEL WITH CAP | | | | A | B | F | M |
| ----- | ----- | 87898-0761 | ----- | ----- | ----- | 7 | ---- | 1 | 17.78 | 15.24 | 11.94 | 8.13 |
| ----- | ----- | 87898-0762 | ----- | ----- | ----- | 7 | ---- | 2 | 17.78 | 15.24 | 11.94 | 8.13 |
| ----- | ----- | 87898-0764 | ----- | ----- | ----- | 7 | ---- | 4 | 17.78 | 15.24 | 11.94 | 8.13 |
| ----- | ----- | 87898-0765 | ----- | ----- | ----- | 7 | ---- | 5 | 17.78 | 15.24 | 11.94 | 8.13 |
| ----- | ----- | 87898-0766 | ----- | ----- | ----- | 7 | ---- | 6 | 17.78 | 15.24 | 11.94 | 8.13 |
| | | | | | | | | | | | | |
| | | | | | | | | | | | | |
| ----- | ----- | 87898-0861 | ----- | ----- | ----- | 8 | ---- | 1 | 20.32 | 17.78 | 11.94 | 8.13 |
| ----- | ----- | 87898-0862 | ----- | ----- | ----- | 8 | ---- | 2 | 20.32 | 17.78 | 11.94 | 8.13 |
| ----- | ----- | 87898-0864 | ----- | ----- | ----- | 8 | ---- | 4 | 20.32 | 17.78 | 11.94 | 8.13 |
| ----- | ----- | 87898-0865 | ----- | ----- | ----- | 8 | ---- | 5 | 20.32 | 17.78 | 11.94 | 8.13 |
| ----- | ----- | 87898-0866 | ----- | ----- | ----- | 8 | ---- | 6 | 20.32 | 17.78 | 11.94 | 8.13 |
| | | | | | | | | | | | | |
| | | | | | | | | | | | | |
| ----- | ----- | 87898-0961 | ----- | ----- | ----- | 9 | ---- | 1 | 22.86 | 20.32 | 11.94 | 8.13 |
| ----- | ----- | 87898-0962 | ----- | ----- | ----- | 9 | ---- | 2 | 22.86 | 20.32 | 11.94 | 8.13 |
| ----- | ----- | 87898-0964 | ----- | ----- | ----- | 9 | ---- | 4 | 22.86 | 20.32 | 11.94 | 8.13 |
| ----- | ----- | 87898-0965 | ----- | ----- | ----- | 9 | ---- | 5 | 22.86 | 20.32 | 11.94 | 8.13 |
| ----- | ----- | 87898-0966 | ----- | ----- | ----- | 9 | ---- | 6 | 22.86 | 20.32 | 11.94 | 8.13 |

THIS DRAWING CONTAINS INFORMATION THAT IS PROPRIETARY TO MOLEX ELECTRONIC TECHNOLOGIES, LLC AND SHOULD NOT BE USED WITHOUT WRITTEN PERMISSION

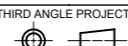
| | | | | | | | | | | | | |
|---------------------------------------|---|-------|------|---|--|--------|--|---|--|----------------|--|--------------|
| DIMENSION UNITS | | SCALE | | CURRENT REV DESC: | | | |  | | | | |
| mm | | NTS | | | | | | | | | | |
| GENERAL TOLERANCES (UNLESS SPECIFIED) | | | | EC NO: 698212 DRWN: DANUSA 2022/03/03 CHK'D: DANUSA 2022/03/04 APPR: MRAMAKRISHNA 2022/03/04 | | | | CUSTOM HEADER 2.54MM PITCH SINGLE ROW SINGLE WAFER SMT HEADER | | | | |
| | | MM | INCH | | | | | | | | | |
| 4 PLACES | ± | | ± | INITIAL REVISION: DRWN: SKLIM01 2005/10/26 APPR: PTLIM 2005/11/07 | | | | PRODUCT CUSTOMER DRAWING DOCUMENT NUMBER: SD-87898-003 DOC TYPE: PSD DOC PART: 001 REVISION: C1 | | | | |
| 3 PLACES | ± | | ± | | | | | | | | | |
| 2 PLACES | ± | 0.2 | ± | DRAFT WHERE APPLICABLE MUST REMAIN WITHIN DIMENSIONS | | | | THIRD ANGLE PROJECTION  | | | | |
| 1 PLACE | ± | | ± | | | | | | | | | |
| 0 PLACES | ± | | ± | DRAWING | | SERIES | | MATERIAL NUMBER | | CUSTOMER | | SHEET NUMBER |
| ANGULAR TOL ± 3.0° | | | | A3-SIZE | | 87898 | | SEE TABLE | | GENERAL MARKET | | 6 OF 17 |

| PACKAGING OPTION PART NO. | | | | | | CKT SIZE | VOID POSITION | PLATING TYPE | DIMENSION | | | |
|---------------------------|---------------|------------------|---------------|-------------------------|----------------------|----------|---------------|--------------|-----------|-------|-------|------|
| TRAY WITHOUT CAP | TRAY WITH CAP | TUBE WITHOUT CAP | TUBE WITH CAP | TAPE & REEL WITHOUT CAP | TAPE & REEL WITH CAP | | | | A | B | F | M |
| ----- | ----- | 87898-1061 | ----- | ----- | ----- | 10 | ---- | 1 | 25.40 | 22.86 | 11.94 | 8.13 |
| ----- | ----- | 87898-1062 | ----- | ----- | ----- | 10 | ---- | 2 | 25.40 | 22.86 | 11.94 | 8.13 |
| ----- | ----- | 87898-1064 | ----- | ----- | ----- | 10 | ---- | 4 | 25.40 | 22.86 | 11.94 | 8.13 |
| ----- | ----- | 87898-1065 | ----- | ----- | ----- | 10 | ---- | 5 | 25.40 | 22.86 | 11.94 | 8.13 |
| ----- | ----- | 87898-1066 | ----- | ----- | ----- | 10 | ---- | 6 | 25.40 | 22.86 | 11.94 | 8.13 |
| | | | | | | | | | | | | |
| | | | | | | | | | | | | |
| ----- | ----- | 87898-1161 | ----- | ----- | ----- | 11 | ---- | 1 | 27.94 | 25.40 | 11.94 | 8.13 |
| ----- | ----- | 87898-1162 | ----- | ----- | ----- | 11 | ---- | 2 | 27.94 | 25.40 | 11.94 | 8.13 |
| ----- | ----- | 87898-1164 | ----- | ----- | ----- | 11 | ---- | 4 | 27.94 | 25.40 | 11.94 | 8.13 |
| ----- | ----- | 87898-1165 | ----- | ----- | ----- | 11 | ---- | 5 | 27.94 | 25.40 | 11.94 | 8.13 |
| ----- | ----- | 87898-1166 | ----- | ----- | ----- | 11 | ---- | 6 | 27.94 | 25.40 | 11.94 | 8.13 |
| | | | | | | | | | | | | |
| | | | | | | | | | | | | |
| ----- | ----- | 87898-1261 | ----- | ----- | ----- | 12 | ---- | 1 | 30.48 | 27.94 | 11.94 | 8.13 |
| ----- | ----- | 87898-1262 | ----- | ----- | ----- | 12 | ---- | 2 | 30.48 | 27.94 | 11.94 | 8.13 |
| ----- | ----- | 87898-1264 | ----- | ----- | ----- | 12 | ---- | 4 | 30.48 | 27.94 | 11.94 | 8.13 |
| ----- | ----- | 87898-1265 | ----- | ----- | ----- | 12 | ---- | 5 | 30.48 | 27.94 | 11.94 | 8.13 |
| ----- | ----- | 87898-1266 | ----- | ----- | ----- | 12 | ---- | 6 | 30.48 | 27.94 | 11.94 | 8.13 |

| | | | | | | | | | | | |
|---|--|-------|--|--|--|------------------------|--|---|--|---|--|
| THIS DRAWING CONTAINS INFORMATION THAT IS PROPRIETARY TO MOLEX ELECTRONIC TECHNOLOGIES, LLC AND SHOULD NOT BE USED WITHOUT WRITTEN PERMISSION | | | | | | | | | | | |
| DIMENSION UNITS | | SCALE | | CURRENT REV DESC: | | | | | |  | |
| mm | | NTS | | EC NO: 698212 | | | | | | | |
| GENERAL TOLERANCES (UNLESS SPECIFIED) | | | | DRWN: DANUSA | | 2022/03/03 | | CUSTOM HEADER | | | |
| | | | | CHK'D: DANUSA | | 2022/03/04 | | 2.54MM PITCH SINGLE ROW SINGLE WAFER SMT HEADER | | | |
| | | | | APPR: MRAMAKRISHNA | | 2022/03/04 | | PRODUCT CUSTOMER DRAWING | | | |
| | | | | INITIAL REVISION: | | | | DOCUMENT NUMBER | | DOC TYPE DOC PART REVISION | |
| 4 PLACES ± | | | | DRWN: SKLIM01 | | 2005/10/26 | | SD-87898-003 | | PSD 001 C1 | |
| 3 PLACES ± | | | | APPR: PTLIM | | 2005/11/07 | | MATERIAL NUMBER | | CUSTOMER | |
| 2 PLACES ± 0.2 | | | | DRAFT WHERE APPLICABLE MUST REMAIN WITHIN DIMENSIONS | | THIRD ANGLE PROJECTION | | DRAWING | | SERIES | |
| 1 PLACE ± | | | | | | | | A3-SIZE | | 87898 | |
| 0 PLACES ± | | | | | | | | SEE TABLE | | GENERAL MARKET | |
| ANGULAR TOL ± 3.0° | | | | | | | | SHEET NUMBER | | 7 OF 17 | |

| PACKAGING OPTION PART NO. | | | | | | CKT SIZE | VOID POSITION | PLATING TYPE | DIMENSION | | | |
|---------------------------|---------------|------------------|---------------|-------------------------|----------------------|----------|---------------|--------------|-----------|-------|-------|------|
| TRAY WITHOUT CAP | TRAY WITH CAP | TUBE WITHOUT CAP | TUBE WITH CAP | TAPE & REEL WITHOUT CAP | TAPE & REEL WITH CAP | | | | A | B | F | M |
| ----- | ----- | 87898-1361 | ----- | ----- | ----- | 13 | ---- | 1 | 33.02 | 30.48 | 11.94 | 8.13 |
| ----- | ----- | 87898-1362 | ----- | ----- | ----- | 13 | ---- | 2 | 33.02 | 30.48 | 11.94 | 8.13 |
| ----- | ----- | 87898-1364 | ----- | ----- | ----- | 13 | ---- | 4 | 33.02 | 30.48 | 11.94 | 8.13 |
| ----- | ----- | 87898-1365 | ----- | ----- | ----- | 13 | ---- | 5 | 33.02 | 30.48 | 11.94 | 8.13 |
| ----- | ----- | 87898-1366 | ----- | ----- | ----- | 13 | ---- | 6 | 33.02 | 30.48 | 11.94 | 8.13 |
| | | | | | | | | | | | | |
| | | | | | | | | | | | | |
| ----- | ----- | 87898-1461 | ----- | ----- | ----- | 14 | ---- | 1 | 35.56 | 33.02 | 11.94 | 8.13 |
| ----- | ----- | 87898-1462 | ----- | ----- | ----- | 14 | ---- | 2 | 35.56 | 33.02 | 11.94 | 8.13 |
| ----- | ----- | 87898-1464 | ----- | ----- | ----- | 14 | ---- | 4 | 35.56 | 33.02 | 11.94 | 8.13 |
| ----- | ----- | 87898-1465 | ----- | ----- | ----- | 14 | ---- | 5 | 35.56 | 33.02 | 11.94 | 8.13 |
| ----- | ----- | 87898-1466 | ----- | ----- | ----- | 14 | ---- | 6 | 35.56 | 33.02 | 11.94 | 8.13 |
| | | | | | | | | | | | | |
| | | | | | | | | | | | | |
| ----- | ----- | 87898-1561 | ----- | ----- | ----- | 15 | ---- | 1 | 38.10 | 35.56 | 11.94 | 8.13 |
| ----- | ----- | 87898-1562 | ----- | ----- | ----- | 15 | ---- | 2 | 38.10 | 35.56 | 11.94 | 8.13 |
| ----- | ----- | 87898-1564 | ----- | ----- | ----- | 15 | ---- | 4 | 38.10 | 35.56 | 11.94 | 8.13 |
| ----- | ----- | 87898-1565 | ----- | ----- | ----- | 15 | ---- | 5 | 38.10 | 35.56 | 11.94 | 8.13 |
| ----- | ----- | 87898-1566 | ----- | ----- | ----- | 15 | ---- | 6 | 38.10 | 35.56 | 11.94 | 8.13 |

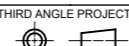
| | | | | | | | | | | | | | | | | | | | | | |
|---|---|-------|------|---|--|--------|--|--|--|---|--|---------------------------|-----------------|------------------------|--|------------------------------|--|----------------------------|--|-------------------------|--|
| THIS DRAWING CONTAINS INFORMATION THAT IS PROPRIETARY TO MOLEX ELECTRONIC TECHNOLOGIES, LLC AND SHOULD NOT BE USED WITHOUT WRITTEN PERMISSION | | | | | | | | | | | | | | | | | | | | | |
| DIMENSION UNITS | | SCALE | | CURRENT REV DESC: | | | | | |  | | | | | | | | | | | |
| mm | | NTS | | | | | | | | | | | | | | | | | | | |
| GENERAL TOLERANCES (UNLESS SPECIFIED) | | | | EC NO: 698212 DRWN: DANUSA 2022/03/03 CHK'D: DANUSA 2022/03/04 APPR: MRAMAKRISHNA 2022/03/04 | | | | | | CUSTOM HEADER 2.54MM PITCH SINGLE ROW SINGLE WAFER SMT HEADER | | | | | | | | | | | |
| | | MM | INCH | | | | | | | | | | | | | | | | | | |
| 4 PLACES | ± | | ± | INITIAL REVISION: DRWN: SKLIM01 2005/10/26 APPR: PTLIM 2005/11/07 | | | | | | DOCUMENT NUMBER SD-87898-003 | | DOC TYPE PSD | DOC PART 001 | REVISION C1 | | | | | | | |
| 3 PLACES | ± | | ± | | | | | | | | | | | | | | | | | | |
| 2 PLACES | ± | 0.2 | ± | DRAFT WHERE APPLICABLE MUST REMAIN WITHIN DIMENSIONS | | | | | | THIRD ANGLE PROJECTION  | | DRAWING A3-SIZE | | SERIES 87898 | | MATERIAL NUMBER SEE TABLE | | CUSTOMER GENERAL MARKET | | SHEET NUMBER 8 OF 17 | |
| 1 PLACE | ± | | ± | | | | | | | | | | | | | | | | | | |
| 0 PLACES | ± | | ± | ANGULAR TOL | | ± 3.0° | | | | | | | | | | | | | | | |

| PACKAGING OPTION PART NO. | | | | | | CKT SIZE | VOID POSITION | PLATING TYPE | DIMENSION | | | |
|---------------------------|---------------|------------------|---------------|-------------------------|----------------------|----------|---------------|--------------|-----------|-------|-------|------|
| TRAY WITHOUT CAP | TRAY WITH CAP | TUBE WITHOUT CAP | TUBE WITH CAP | TAPE & REEL WITHOUT CAP | TAPE & REEL WITH CAP | | | | A | B | F | M |
| ----- | ----- | 87898-1661 | ----- | ----- | ----- | 16 | ---- | 1 | 40.64 | 38.10 | 11.94 | 8.13 |
| ----- | ----- | 87898-1662 | ----- | ----- | ----- | 16 | ---- | 2 | 40.64 | 38.10 | 11.94 | 8.13 |
| ----- | ----- | 87898-1664 | ----- | ----- | ----- | 16 | ---- | 4 | 40.64 | 38.10 | 11.94 | 8.13 |
| ----- | ----- | 87898-1665 | ----- | ----- | ----- | 16 | ---- | 5 | 40.64 | 38.10 | 11.94 | 8.13 |
| ----- | ----- | 87898-1666 | ----- | ----- | ----- | 16 | ---- | 6 | 40.64 | 38.10 | 11.94 | 8.13 |
| | | | | | | | | | | | | |
| | | | | | | | | | | | | |
| ----- | ----- | 87898-1761 | ----- | ----- | ----- | 17 | ---- | 1 | 43.18 | 40.64 | 11.94 | 8.13 |
| ----- | ----- | 87898-1762 | ----- | ----- | ----- | 17 | ---- | 2 | 43.18 | 40.64 | 11.94 | 8.13 |
| ----- | ----- | 87898-1764 | ----- | ----- | ----- | 17 | ---- | 4 | 43.18 | 40.64 | 11.94 | 8.13 |
| ----- | ----- | 87898-1765 | ----- | ----- | ----- | 17 | ---- | 5 | 43.18 | 40.64 | 11.94 | 8.13 |
| ----- | ----- | 87898-1766 | ----- | ----- | ----- | 17 | ---- | 6 | 43.18 | 40.64 | 11.94 | 8.13 |
| | | | | | | | | | | | | |
| | | | | | | | | | | | | |
| ----- | ----- | 87898-1861 | ----- | ----- | ----- | 18 | ---- | 1 | 45.72 | 43.18 | 11.94 | 8.13 |
| ----- | ----- | 87898-1862 | ----- | ----- | ----- | 18 | ---- | 2 | 45.72 | 43.18 | 11.94 | 8.13 |
| ----- | ----- | 87898-1864 | ----- | ----- | ----- | 18 | ---- | 4 | 45.72 | 43.18 | 11.94 | 8.13 |
| ----- | ----- | 87898-1865 | ----- | ----- | ----- | 18 | ---- | 5 | 45.72 | 43.18 | 11.94 | 8.13 |
| ----- | ----- | 87898-1866 | ----- | ----- | ----- | 18 | ---- | 6 | 45.72 | 43.18 | 11.94 | 8.13 |

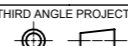
| | | | | | | | | | | | | | | | | | | |
|---|--|--------|-------|--|--|------------------------|--|---------|--|---|--|--|--|--------------|----|----------------|----------|--------------|
| THIS DRAWING CONTAINS INFORMATION THAT IS PROPRIETARY TO MOLEX ELECTRONIC TECHNOLOGIES, LLC AND SHOULD NOT BE USED WITHOUT WRITTEN PERMISSION | | | | | | | | | | | | | | | | | | |
| DIMENSION UNITS | | SCALE | | CURRENT REV DESC: | | | | | |  | | | | | | | | |
| mm | | NTS | | | | | | | | | | | | | | | | |
| GENERAL TOLERANCES (UNLESS SPECIFIED) | | | | EC NO: 698212 DRWN: DANUSA 2022/03/03 CHK'D: DANUSA 2022/03/04 APPR: MRAMAKRISHNA 2022/03/04 INITIAL REVISION: DRWN: SKLIM01 2005/10/26 APPR: PTLIM 2005/11/07 | | | | | | CUSTOMER DRAWING | | | | | | | | |
| 4 PLACES | | ± | ± | | | | | | | DOCUMENT NUMBER | | | | SD-87898-003 | | DOC TYPE | DOC PART | REVISION |
| 3 PLACES | | ± | ± | | | | | | | PSD | | | | 001 | C1 | | | |
| 2 PLACES | | ± | 0.2 ± | | | | | | | MATERIAL NUMBER | | | | SEE TABLE | | CUSTOMER | | SHEET NUMBER |
| 1 PLACE | | ± | ± | | | | | | | A3-SIZE | | | | 87898 | | GENERAL MARKET | | 9 OF 17 |
| 0 PLACES | | ± | ± | DRAFT WHERE APPLICABLE MUST REMAIN WITHIN DIMENSIONS | | THIRD ANGLE PROJECTION | | DRAWING | | SERIES | | | | | | | | |
| ANGULAR TOL | | ± 3.0° | |  | | | | | | | | | | | | | | |

| PACKAGING OPTION PART NO. | | | | | | CKT SIZE | VOID POSITION | PLATING TYPE | DIMENSION | | | |
|---------------------------|---------------|------------------|---------------|-------------------------|----------------------|----------|---------------|--------------|-----------|-------|-------|------|
| TRAY WITHOUT CAP | TRAY WITH CAP | TUBE WITHOUT CAP | TUBE WITH CAP | TAPE & REEL WITHOUT CAP | TAPE & REEL WITH CAP | | | | A | B | F | M |
| ----- | ----- | 87898-1961 | ----- | ----- | ----- | 19 | ---- | 1 | 48.26 | 45.72 | 11.94 | 8.13 |
| ----- | ----- | 87898-1962 | ----- | ----- | ----- | 19 | ---- | 2 | 48.26 | 45.72 | 11.94 | 8.13 |
| ----- | ----- | 87898-1964 | ----- | ----- | ----- | 19 | ---- | 4 | 48.26 | 45.72 | 11.94 | 8.13 |
| ----- | ----- | 87898-1965 | ----- | ----- | ----- | 19 | ---- | 5 | 48.26 | 45.72 | 11.94 | 8.13 |
| ----- | ----- | 87898-1966 | ----- | ----- | ----- | 19 | ---- | 6 | 48.26 | 45.72 | 11.94 | 8.13 |
| | | | | | | | | | | | | |
| | | | | | | | | | | | | |
| ----- | ----- | 87898-2061 | ----- | ----- | ----- | 20 | ---- | 1 | 50.80 | 48.26 | 11.94 | 8.13 |
| ----- | ----- | 87898-2062 | ----- | ----- | ----- | 20 | ---- | 2 | 50.80 | 48.26 | 11.94 | 8.13 |
| ----- | ----- | 87898-2064 | ----- | ----- | ----- | 20 | ---- | 4 | 50.80 | 48.26 | 11.94 | 8.13 |
| ----- | ----- | 87898-2065 | ----- | ----- | ----- | 20 | ---- | 5 | 50.80 | 48.26 | 11.94 | 8.13 |
| ----- | ----- | 87898-2066 | ----- | ----- | ----- | 20 | ---- | 6 | 50.80 | 48.26 | 11.94 | 8.13 |
| | | | | | | | | | | | | |
| | | | | | | | | | | | | |
| ----- | ----- | 87898-2161 | ----- | ----- | ----- | 21 | ---- | 1 | 53.34 | 50.80 | 11.94 | 8.13 |
| ----- | ----- | 87898-2162 | ----- | ----- | ----- | 21 | ---- | 2 | 53.34 | 50.80 | 11.94 | 8.13 |
| ----- | ----- | 87898-2164 | ----- | ----- | ----- | 21 | ---- | 4 | 53.34 | 50.80 | 11.94 | 8.13 |
| ----- | ----- | 87898-2165 | ----- | ----- | ----- | 21 | ---- | 5 | 53.34 | 50.80 | 11.94 | 8.13 |
| ----- | ----- | 87898-2166 | ----- | ----- | ----- | 21 | ---- | 6 | 53.34 | 50.80 | 11.94 | 8.13 |

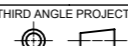
| | | | | | | | | | | | | |
|---|--|-------|--|---|--|------------|--|--|--|---|----------|--------------|
| THIS DRAWING CONTAINS INFORMATION THAT IS PROPRIETARY TO MOLEX ELECTRONIC TECHNOLOGIES, LLC AND SHOULD NOT BE USED WITHOUT WRITTEN PERMISSION | | | | | | | | | | | | |
| DIMENSION UNITS | | SCALE | | CURRENT REV DESC: | | | | | |  | | |
| mm | | NTS | | EC NO: 698212 | | | | | | | | |
| GENERAL TOLERANCES (UNLESS SPECIFIED) | | | | DRWN: DANUSA | | 2022/03/03 | | CUSTOM HEADER 2.54MM PITCH SINGLE ROW SINGLE WAFER SMT HEADER | | | | |
| | | | | CHK'D: DANUSA | | 2022/03/04 | | | | | | |
| | | | | APPR: MRAMAKRISHNA | | 2022/03/04 | | PRODUCT CUSTOMER DRAWING | | | | |
| | | | | INITIAL REVISION: | | | | DOCUMENT NUMBER | | DOC TYPE | DOC PART | REVISION |
| | | | | DRWN: SKLIM01 | | 2005/10/26 | | SD-87898-003 | | PSD | 001 | C1 |
| | | | | APPR: PTLIM | | 2005/11/07 | | MATERIAL NUMBER | | CUSTOMER | | SHEET NUMBER |
| DRAFT WHERE APPLICABLE MUST REMAIN WITHIN DIMENSIONS | | | | THIRD ANGLE PROJECTION | | DRAWING | | SERIES | | GENERAL MARKET | | 10 OF 17 |
| | | | |  | | A3-SIZE | | 87898 | | | | |

| PACKAGING OPTION PART NO. | | | | | | CKT SIZE | VOID POSITION | PLATING TYPE | DIMENSION | | | |
|---------------------------|---------------|------------------|---------------|-------------------------|----------------------|----------|---------------|--------------|-----------|-------|-------|------|
| TRAY WITHOUT CAP | TRAY WITH CAP | TUBE WITHOUT CAP | TUBE WITH CAP | TAPE & REEL WITHOUT CAP | TAPE & REEL WITH CAP | | | | A | B | F | M |
| ----- | ----- | 87898-2261 | ----- | ----- | ----- | 22 | ---- | 1 | 55.88 | 53.34 | 11.94 | 8.13 |
| ----- | ----- | 87898-2262 | ----- | ----- | ----- | 22 | ---- | 2 | 55.88 | 53.34 | 11.94 | 8.13 |
| ----- | ----- | 87898-2264 | ----- | ----- | ----- | 22 | ---- | 4 | 55.88 | 53.34 | 11.94 | 8.13 |
| ----- | ----- | 87898-2265 | ----- | ----- | ----- | 22 | ---- | 5 | 55.88 | 53.34 | 11.94 | 8.13 |
| ----- | ----- | 87898-2266 | ----- | ----- | ----- | 22 | ---- | 6 | 55.88 | 53.34 | 11.94 | 8.13 |
| | | | | | | | | | | | | |
| | | | | | | | | | | | | |
| ----- | ----- | 87898-2361 | ----- | ----- | ----- | 23 | ---- | 1 | 58.42 | 55.88 | 11.94 | 8.13 |
| ----- | ----- | 87898-2362 | ----- | ----- | ----- | 23 | ---- | 2 | 58.42 | 55.88 | 11.94 | 8.13 |
| ----- | ----- | 87898-2364 | ----- | ----- | ----- | 23 | ---- | 4 | 58.42 | 55.88 | 11.94 | 8.13 |
| ----- | ----- | 87898-2365 | ----- | ----- | ----- | 23 | ---- | 5 | 58.42 | 55.88 | 11.94 | 8.13 |
| ----- | ----- | 87898-2366 | ----- | ----- | ----- | 23 | ---- | 6 | 58.42 | 55.88 | 11.94 | 8.13 |
| | | | | | | | | | | | | |
| | | | | | | | | | | | | |
| ----- | ----- | 87898-2461 | ----- | ----- | ----- | 24 | ---- | 1 | 60.96 | 58.42 | 11.94 | 8.13 |
| ----- | ----- | 87898-2462 | ----- | ----- | ----- | 24 | ---- | 2 | 60.96 | 58.42 | 11.94 | 8.13 |
| ----- | ----- | 87898-2464 | ----- | ----- | ----- | 24 | ---- | 4 | 60.96 | 58.42 | 11.94 | 8.13 |
| ----- | ----- | 87898-2465 | ----- | ----- | ----- | 24 | ---- | 5 | 60.96 | 58.42 | 11.94 | 8.13 |
| ----- | ----- | 87898-2466 | ----- | ----- | ----- | 24 | ---- | 6 | 60.96 | 58.42 | 11.94 | 8.13 |

| | | | | | | | | | | | | |
|---|---|--------|------|---|--|---------|--------|---|--|----------------|----------|--------------|
| THIS DRAWING CONTAINS INFORMATION THAT IS PROPRIETARY TO MOLEX ELECTRONIC TECHNOLOGIES, LLC AND SHOULD NOT BE USED WITHOUT WRITTEN PERMISSION | | | | | | | | | | | | |
| DIMENSION UNITS | | SCALE | | CURRENT REV DESC: | | | |  | | | | |
| mm | | NTS | | | | | | | | | | |
| GENERAL TOLERANCES (UNLESS SPECIFIED) | | | | EC NO: 698212 DRWN: DANUSA 2022/03/03 CHK'D: DANUSA 2022/03/04 APPR: MRAMAKRISHNA 2022/03/04 | | | | CUSTOM HEADER 2.54MM PITCH SINGLE ROW SINGLE WAFER SMT HEADER | | | | |
| | | MM | INCH | | | | | | | | | |
| 4 PLACES | ± | | ± | INITIAL REVISION: DRWN: SKLIM01 2005/10/26 APPR: PTLIM 2005/11/07 | | | | DOCUMENT NUMBER | | DOC TYPE | DOC PART | REVISION |
| 3 PLACES | ± | | ± | | | | | SD-87898-003 | | PSD | 001 | C1 |
| 2 PLACES | ± | 0.2 | ± | DRAFT WHERE APPLICABLE MUST REMAIN WITHIN DIMENSIONS | | | | MATERIAL NUMBER | | CUSTOMER | | SHEET NUMBER |
| 1 PLACE | ± | | ± | | | | | SEE TABLE | | GENERAL MARKET | | 11 OF 17 |
| 0 PLACES | ± | | ± | THIRD ANGLE PROJECTION | | DRAWING | SERIES | A3-SIZE | | 87898 | | |
| ANGULAR TOL | | ± 3.0° | | DRAWING | | SERIES | | MATERIAL NUMBER | | CUSTOMER | | |

| PACKAGING OPTION PART NO. | | | | | | CKT SIZE | VOID POSITION | PLATING TYPE | DIMENSION | | | |
|---------------------------|---------------|------------------|---------------|-------------------------|----------------------|----------|---------------|--------------|-----------|-------|-------|------|
| TRAY WITHOUT CAP | TRAY WITH CAP | TUBE WITHOUT CAP | TUBE WITH CAP | TAPE & REEL WITHOUT CAP | TAPE & REEL WITH CAP | | | | A | B | F | M |
| ----- | ----- | 87898-2561 | ----- | ----- | ----- | 25 | ---- | 1 | 63.50 | 60.96 | 11.94 | 8.13 |
| ----- | ----- | 87898-2562 | ----- | ----- | ----- | 25 | ---- | 2 | 63.50 | 60.96 | 11.94 | 8.13 |
| ----- | ----- | 87898-2564 | ----- | ----- | ----- | 25 | ---- | 4 | 63.50 | 60.96 | 11.94 | 8.13 |
| ----- | ----- | 87898-2565 | ----- | ----- | ----- | 25 | ---- | 5 | 63.50 | 60.96 | 11.94 | 8.13 |
| ----- | ----- | 87898-2566 | ----- | ----- | ----- | 25 | ---- | 6 | 63.50 | 60.96 | 11.94 | 8.13 |
| | | | | | | | | | | | | |
| | | | | | | | | | | | | |
| ----- | ----- | 87898-2661 | ----- | ----- | ----- | 26 | ---- | 1 | 66.04 | 63.50 | 11.94 | 8.13 |
| ----- | ----- | 87898-2662 | ----- | ----- | ----- | 26 | ---- | 2 | 66.04 | 63.50 | 11.94 | 8.13 |
| ----- | ----- | 87898-2664 | ----- | ----- | ----- | 26 | ---- | 4 | 66.04 | 63.50 | 11.94 | 8.13 |
| ----- | ----- | 87898-2665 | ----- | ----- | ----- | 26 | ---- | 5 | 66.04 | 63.50 | 11.94 | 8.13 |
| ----- | ----- | 87898-2666 | ----- | ----- | ----- | 26 | ---- | 6 | 66.04 | 63.50 | 11.94 | 8.13 |
| | | | | | | | | | | | | |
| | | | | | | | | | | | | |
| ----- | ----- | 87898-2761 | ----- | ----- | ----- | 27 | ---- | 1 | 68.58 | 66.04 | 11.94 | 8.13 |
| ----- | ----- | 87898-2762 | ----- | ----- | ----- | 27 | ---- | 2 | 68.58 | 66.04 | 11.94 | 8.13 |
| ----- | ----- | 87898-2764 | ----- | ----- | ----- | 27 | ---- | 4 | 68.58 | 66.04 | 11.94 | 8.13 |
| ----- | ----- | 87898-2765 | ----- | ----- | ----- | 27 | ---- | 5 | 68.58 | 66.04 | 11.94 | 8.13 |
| ----- | ----- | 87898-2766 | ----- | ----- | ----- | 27 | ---- | 6 | 68.58 | 66.04 | 11.94 | 8.13 |

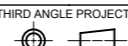
| | | | | | | | | | | | | |
|---|---|--------|------|---|--|---------|--------|---|--|----------------|----------|--------------|
| THIS DRAWING CONTAINS INFORMATION THAT IS PROPRIETARY TO MOLEX ELECTRONIC TECHNOLOGIES, LLC AND SHOULD NOT BE USED WITHOUT WRITTEN PERMISSION | | | | | | | | | | | | |
| DIMENSION UNITS | | SCALE | | CURRENT REV DESC: | | | |  | | | | |
| mm | | NTS | | | | | | | | | | |
| GENERAL TOLERANCES (UNLESS SPECIFIED) | | | | EC NO: 698212 DRWN: DANUSA 2022/03/03 CHK'D: DANUSA 2022/03/04 APPR: MRAMAKRISHNA 2022/03/04 | | | | CUSTOM HEADER 2.54MM PITCH SINGLE ROW SINGLE WAFER SMT HEADER | | | | |
| | | MM | INCH | | | | | | | | | |
| 4 PLACES | ± | | ± | INITIAL REVISION: DRWN: SKLIM01 2005/10/26 APPR: PTLIM 2005/11/07 | | | | DOCUMENT NUMBER | | DOC TYPE | DOC PART | REVISION |
| 3 PLACES | ± | | ± | | | | | SD-87898-003 | | PSD | 001 | C1 |
| 2 PLACES | ± | 0.2 | ± | DRAFT WHERE APPLICABLE MUST REMAIN WITHIN DIMENSIONS | | | | MATERIAL NUMBER | | CUSTOMER | | SHEET NUMBER |
| 1 PLACE | ± | | ± | | | | | SEE TABLE | | GENERAL MARKET | | 12 OF 17 |
| 0 PLACES | ± | | ± | THIRD ANGLE PROJECTION | | DRAWING | SERIES | CUSTOMER | | SHEET NUMBER | | |
| ANGULAR TOL | | ± 3.0° | |  | | A3-SIZE | 87898 | GENERAL MARKET | | 12 OF 17 | | |

| PACKAGING OPTION PART NO. | | | | | | CKT SIZE | VOID POSITION | PLATING TYPE | DIMENSION | | | |
|---------------------------|---------------|------------------|---------------|-------------------------|----------------------|----------|---------------|--------------|-----------|-------|-------|------|
| TRAY WITHOUT CAP | TRAY WITH CAP | TUBE WITHOUT CAP | TUBE WITH CAP | TAPE & REEL WITHOUT CAP | TAPE & REEL WITH CAP | | | | A | B | F | M |
| ----- | ----- | 87898-2861 | ----- | ----- | ----- | 28 | ---- | 1 | 71.12 | 68.58 | 11.94 | 8.13 |
| ----- | ----- | 87898-2862 | ----- | ----- | ----- | 28 | ---- | 2 | 71.12 | 68.58 | 11.94 | 8.13 |
| ----- | ----- | 87898-2864 | ----- | ----- | ----- | 28 | ---- | 4 | 71.12 | 68.58 | 11.94 | 8.13 |
| ----- | ----- | 87898-2865 | ----- | ----- | ----- | 28 | ---- | 5 | 71.12 | 68.58 | 11.94 | 8.13 |
| ----- | ----- | 87898-2866 | ----- | ----- | ----- | 28 | ---- | 6 | 71.12 | 68.58 | 11.94 | 8.13 |
| | | | | | | | | | | | | |
| | | | | | | | | | | | | |
| ----- | ----- | 87898-2961 | ----- | ----- | ----- | 29 | ---- | 1 | 73.66 | 71.12 | 11.94 | 8.13 |
| ----- | ----- | 87898-2962 | ----- | ----- | ----- | 29 | ---- | 2 | 73.66 | 71.12 | 11.94 | 8.13 |
| ----- | ----- | 87898-2964 | ----- | ----- | ----- | 29 | ---- | 4 | 73.66 | 71.12 | 11.94 | 8.13 |
| ----- | ----- | 87898-2965 | ----- | ----- | ----- | 29 | ---- | 5 | 73.66 | 71.12 | 11.94 | 8.13 |
| ----- | ----- | 87898-2966 | ----- | ----- | ----- | 29 | ---- | 6 | 73.66 | 71.12 | 11.94 | 8.13 |
| | | | | | | | | | | | | |
| | | | | | | | | | | | | |
| ----- | ----- | 87898-3061 | ----- | ----- | ----- | 30 | ---- | 1 | 76.20 | 73.66 | 11.94 | 8.13 |
| ----- | ----- | 87898-3062 | ----- | ----- | ----- | 30 | ---- | 2 | 76.20 | 73.66 | 11.94 | 8.13 |
| ----- | ----- | 87898-3064 | ----- | ----- | ----- | 30 | ---- | 4 | 76.20 | 73.66 | 11.94 | 8.13 |
| ----- | ----- | 87898-3065 | ----- | ----- | ----- | 30 | ---- | 5 | 76.20 | 73.66 | 11.94 | 8.13 |
| ----- | ----- | 87898-3066 | ----- | ----- | ----- | 30 | ---- | 6 | 76.20 | 73.66 | 11.94 | 8.13 |

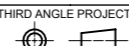
| | | | | | | | | | | | | |
|---|---|---|------|---|-------|----------------|--------|---|--|----------------|----------|--------------|
| THIS DRAWING CONTAINS INFORMATION THAT IS PROPRIETARY TO MOLEX ELECTRONIC TECHNOLOGIES, LLC AND SHOULD NOT BE USED WITHOUT WRITTEN PERMISSION | | | | | | | | | | | | |
| DIMENSION UNITS | | SCALE | | CURRENT REV DESC: | | | |  | | | | |
| mm | | NTS | | | | | | | | | | |
| GENERAL TOLERANCES (UNLESS SPECIFIED) | | | | EC NO: 698212 DRWN: DANUSA 2022/03/03 CHK'D: DANUSA 2022/03/04 APPR: MRAMAKRISHNA 2022/03/04 | | | | CUSTOM HEADER 2.54MM PITCH SINGLE ROW SINGLE WAFER SMT HEADER | | | | |
| | | MM | INCH | | | | | | | | | |
| 4 PLACES | ± | | ± | INITIAL REVISION: DRWN: SKLIM01 2005/10/26 APPR: PTLIM 2005/11/07 | | | | DOCUMENT NUMBER | | DOC TYPE | DOC PART | REVISION |
| 3 PLACES | ± | | ± | | | | | SD-87898-003 | | PSD | 001 | C1 |
| 2 PLACES | ± | 0.2 | ± | DRAFT WHERE APPLICABLE MUST REMAIN WITHIN DIMENSIONS | | | | MATERIAL NUMBER | | CUSTOMER | | SHEET NUMBER |
| 1 PLACE | ± | | ± | | | | | SEE TABLE | | GENERAL MARKET | | 13 OF 17 |
| 0 PLACES | ± | | ± | THIRD ANGLE PROJECTION | | DRAWING | SERIES | CUSTOMER | | SHEET NUMBER | | |
| ANGULAR TOL ± 3.0° | |  | | A3-SIZE | 87898 | GENERAL MARKET | | 13 OF 17 | | | | |

| PACKAGING OPTION PART NO. | | | | | | CKT SIZE | VOID POSITION | PLATING TYPE | DIMENSION | | | |
|---------------------------|---------------|------------------|---------------|-------------------------|----------------------|----------|---------------|--------------|-----------|-------|-------|------|
| TRAY WITHOUT CAP | TRAY WITH CAP | TUBE WITHOUT CAP | TUBE WITH CAP | TAPE & REEL WITHOUT CAP | TAPE & REEL WITH CAP | | | | A | B | F | M |
| ----- | ----- | 87898-3161 | ----- | ----- | ----- | 31 | ---- | 1 | 78.74 | 76.20 | 11.94 | 8.13 |
| ----- | ----- | 87898-3162 | ----- | ----- | ----- | 31 | ---- | 2 | 78.74 | 76.20 | 11.94 | 8.13 |
| ----- | ----- | 87898-3164 | ----- | ----- | ----- | 31 | ---- | 4 | 78.74 | 76.20 | 11.94 | 8.13 |
| ----- | ----- | 87898-3165 | ----- | ----- | ----- | 31 | ---- | 5 | 78.74 | 76.20 | 11.94 | 8.13 |
| ----- | ----- | 87898-3166 | ----- | ----- | ----- | 31 | ---- | 6 | 78.74 | 76.20 | 11.94 | 8.13 |
| | | | | | | | | | | | | |
| | | | | | | | | | | | | |
| ----- | ----- | 87898-3261 | ----- | ----- | ----- | 32 | ---- | 1 | 81.28 | 78.74 | 11.94 | 8.13 |
| ----- | ----- | 87898-3262 | ----- | ----- | ----- | 32 | ---- | 2 | 81.28 | 78.74 | 11.94 | 8.13 |
| ----- | ----- | 87898-3264 | ----- | ----- | ----- | 32 | ---- | 4 | 81.28 | 78.74 | 11.94 | 8.13 |
| ----- | ----- | 87898-3265 | ----- | ----- | ----- | 32 | ---- | 5 | 81.28 | 78.74 | 11.94 | 8.13 |
| ----- | ----- | 87898-3266 | ----- | ----- | ----- | 32 | ---- | 6 | 81.28 | 78.74 | 11.94 | 8.13 |
| | | | | | | | | | | | | |
| | | | | | | | | | | | | |
| ----- | ----- | 87898-3361 | ----- | ----- | ----- | 33 | ---- | 1 | 83.82 | 81.28 | 11.94 | 8.13 |
| ----- | ----- | 87898-3362 | ----- | ----- | ----- | 33 | ---- | 2 | 83.82 | 81.28 | 11.94 | 8.13 |
| ----- | ----- | 87898-3364 | ----- | ----- | ----- | 33 | ---- | 4 | 83.82 | 81.28 | 11.94 | 8.13 |
| ----- | ----- | 87898-3365 | ----- | ----- | ----- | 33 | ---- | 5 | 83.82 | 81.28 | 11.94 | 8.13 |
| ----- | ----- | 87898-3366 | ----- | ----- | ----- | 33 | ---- | 6 | 83.82 | 81.28 | 11.94 | 8.13 |

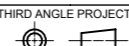
| | | | | | | | | | | | | |
|---|---|--------|------|---|--|---------|--------|---|--|----------------|----------|--------------|
| THIS DRAWING CONTAINS INFORMATION THAT IS PROPRIETARY TO MOLEX ELECTRONIC TECHNOLOGIES, LLC AND SHOULD NOT BE USED WITHOUT WRITTEN PERMISSION | | | | | | | | | | | | |
| DIMENSION UNITS | | SCALE | | CURRENT REV DESC: | | | |  | | | | |
| mm | | NTS | | | | | | | | | | |
| GENERAL TOLERANCES (UNLESS SPECIFIED) | | | | EC NO: 698212 DRWN: DANUSA 2022/03/03 CHK'D: DANUSA 2022/03/04 APPR: MRAMAKRISHNA 2022/03/04 | | | | CUSTOM HEADER 2.54MM PITCH SINGLE ROW SINGLE WAFER SMT HEADER | | | | |
| | | MM | INCH | | | | | | | | | |
| 4 PLACES | ± | | ± | INITIAL REVISION: DRWN: SKLIM01 2005/10/26 APPR: PTLIM 2005/11/07 | | | | DOCUMENT NUMBER | | DOC TYPE | DOC PART | REVISION |
| 3 PLACES | ± | | ± | | | | | SD-87898-003 | | PSD | 001 | C1 |
| 2 PLACES | ± | 0.2 | ± | DRAFT WHERE APPLICABLE MUST REMAIN WITHIN DIMENSIONS | | | | MATERIAL NUMBER | | CUSTOMER | | SHEET NUMBER |
| 1 PLACE | ± | | ± | | | | | SEE TABLE | | GENERAL MARKET | | 14 OF 17 |
| 0 PLACES | ± | | ± | THIRD ANGLE PROJECTION | | DRAWING | SERIES | CUSTOMER | | SHEET NUMBER | | |
| ANGULAR TOL | | ± 3.0° | |  | | A3-SIZE | 87898 | GENERAL MARKET | | 14 OF 17 | | |

| PACKAGING OPTION PART NO. | | | | | | CKT SIZE | VOID POSITION | PLATING TYPE | DIMENSION | | | |
|---------------------------|---------------|------------------|---------------|-------------------------|----------------------|----------|---------------|--------------|-----------|-------|-------|------|
| TRAY WITHOUT CAP | TRAY WITH CAP | TUBE WITHOUT CAP | TUBE WITH CAP | TAPE & REEL WITHOUT CAP | TAPE & REEL WITH CAP | | | | A | B | F | M |
| ----- | ----- | 87898-3461 | ----- | ----- | ----- | 34 | ---- | 1 | 86.36 | 83.82 | 11.94 | 8.13 |
| ----- | ----- | 87898-3462 | ----- | ----- | ----- | 34 | ---- | 2 | 86.36 | 83.82 | 11.94 | 8.13 |
| ----- | ----- | 87898-3464 | ----- | ----- | ----- | 34 | ---- | 4 | 86.36 | 83.82 | 11.94 | 8.13 |
| ----- | ----- | 87898-3465 | ----- | ----- | ----- | 34 | ---- | 5 | 86.36 | 83.82 | 11.94 | 8.13 |
| ----- | ----- | 87898-3466 | ----- | ----- | ----- | 34 | ---- | 6 | 86.36 | 83.82 | 11.94 | 8.13 |
| | | | | | | | | | | | | |
| | | | | | | | | | | | | |
| ----- | ----- | 87898-3561 | ----- | ----- | ----- | 35 | ---- | 1 | 88.90 | 86.36 | 11.94 | 8.13 |
| ----- | ----- | 87898-3562 | ----- | ----- | ----- | 35 | ---- | 2 | 88.90 | 86.36 | 11.94 | 8.13 |
| ----- | ----- | 87898-3564 | ----- | ----- | ----- | 35 | ---- | 4 | 88.90 | 86.36 | 11.94 | 8.13 |
| ----- | ----- | 87898-3565 | ----- | ----- | ----- | 35 | ---- | 5 | 88.90 | 86.36 | 11.94 | 8.13 |
| ----- | ----- | 87898-3566 | ----- | ----- | ----- | 35 | ---- | 6 | 88.90 | 86.36 | 11.94 | 8.13 |
| | | | | | | | | | | | | |
| | | | | | | | | | | | | |
| ----- | ----- | 87898-3661 | ----- | ----- | ----- | 36 | ---- | 1 | 91.44 | 88.90 | 11.94 | 8.13 |
| ----- | ----- | 87898-3662 | ----- | ----- | ----- | 36 | ---- | 2 | 91.44 | 88.90 | 11.94 | 8.13 |
| ----- | ----- | 87898-3664 | ----- | ----- | ----- | 36 | ---- | 4 | 91.44 | 88.90 | 11.94 | 8.13 |
| ----- | ----- | 87898-3665 | ----- | ----- | ----- | 36 | ---- | 5 | 91.44 | 88.90 | 11.94 | 8.13 |
| ----- | ----- | 87898-3666 | ----- | ----- | ----- | 36 | ---- | 6 | 91.44 | 88.90 | 11.94 | 8.13 |

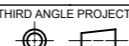
| | | | | | | | | | | | | |
|---|---|---|------|---|-------|-----------|--------|---|--|----------------|----------|--------------|
| THIS DRAWING CONTAINS INFORMATION THAT IS PROPRIETARY TO MOLEX ELECTRONIC TECHNOLOGIES, LLC AND SHOULD NOT BE USED WITHOUT WRITTEN PERMISSION | | | | | | | | | | | | |
| DIMENSION UNITS | | SCALE | | CURRENT REV DESC: | | | |  | | | | |
| mm | | NTS | | | | | | | | | | |
| GENERAL TOLERANCES (UNLESS SPECIFIED) | | | | EC NO: 698212 DRWN: DANUSA 2022/03/03 CHK'D: DANUSA 2022/03/04 APPR: MRAMAKRISHNA 2022/03/04 | | | | CUSTOM HEADER 2.54MM PITCH SINGLE ROW SINGLE WAFER SMT HEADER | | | | |
| | | MM | INCH | | | | | | | | | |
| 4 PLACES | ± | | ± | INITIAL REVISION: DRWN: SKLIM01 2005/10/26 APPR: PTLIM 2005/11/07 | | | | DOCUMENT NUMBER | | DOC TYPE | DOC PART | REVISION |
| 3 PLACES | ± | | ± | | | | | SD-87898-003 | | PSD | 001 | C1 |
| 2 PLACES | ± | 0.2 | ± | DRAFT WHERE APPLICABLE MUST REMAIN WITHIN DIMENSIONS | | | | MATERIAL NUMBER | | CUSTOMER | | SHEET NUMBER |
| 1 PLACE | ± | | ± | | | | | SEE TABLE | | GENERAL MARKET | | 15 OF 17 |
| 0 PLACES | ± | | ± | THIRD ANGLE PROJECTION | | DRAWING | SERIES | CUSTOMER | | SHEET NUMBER | | |
| ANGULAR TOL ± 3.0° | |  | | A3-SIZE | 87898 | SEE TABLE | | GENERAL MARKET | | 15 OF 17 | | |

| PACKAGING OPTION PART NO. | | | | | | CKT SIZE | VOID POSITION | PLATING TYPE | DIMENSION | | | |
|---------------------------|---------------|------------------|---------------|-------------------------|----------------------|----------|---------------|--------------|-----------|-------|-------|------|
| TRAY WITHOUT CAP | TRAY WITH CAP | TUBE WITHOUT CAP | TUBE WITH CAP | TAPE & REEL WITHOUT CAP | TAPE & REEL WITH CAP | | | | A | B | F | M |
| ----- | ----- | 87898-3761 | ----- | ----- | ----- | 37 | ---- | 1 | 93.98 | 91.44 | 11.94 | 8.13 |
| ----- | ----- | 87898-3762 | ----- | ----- | ----- | 37 | ---- | 2 | 93.98 | 91.44 | 11.94 | 8.13 |
| ----- | ----- | 87898-3764 | ----- | ----- | ----- | 37 | ---- | 4 | 93.98 | 91.44 | 11.94 | 8.13 |
| ----- | ----- | 87898-3765 | ----- | ----- | ----- | 37 | ---- | 5 | 93.98 | 91.44 | 11.94 | 8.13 |
| ----- | ----- | 87898-3766 | ----- | ----- | ----- | 37 | ---- | 6 | 93.98 | 91.44 | 11.94 | 8.13 |
| | | | | | | | | | | | | |
| | | | | | | | | | | | | |
| ----- | ----- | 87898-3861 | ----- | ----- | ----- | 38 | ---- | 1 | 96.52 | 93.98 | 11.94 | 8.13 |
| ----- | ----- | 87898-3862 | ----- | ----- | ----- | 38 | ---- | 2 | 96.52 | 93.98 | 11.94 | 8.13 |
| ----- | ----- | 87898-3864 | ----- | ----- | ----- | 38 | ---- | 4 | 96.52 | 93.98 | 11.94 | 8.13 |
| ----- | ----- | 87898-3865 | ----- | ----- | ----- | 38 | ---- | 5 | 96.52 | 93.98 | 11.94 | 8.13 |
| ----- | ----- | 87898-3866 | ----- | ----- | ----- | 38 | ---- | 6 | 96.52 | 93.98 | 11.94 | 8.13 |
| | | | | | | | | | | | | |
| | | | | | | | | | | | | |
| ----- | ----- | 87898-3961 | ----- | ----- | ----- | 39 | ---- | 1 | 99.06 | 96.52 | 11.94 | 8.13 |
| ----- | ----- | 87898-3962 | ----- | ----- | ----- | 39 | ---- | 2 | 99.06 | 96.52 | 11.94 | 8.13 |
| ----- | ----- | 87898-3964 | ----- | ----- | ----- | 39 | ---- | 4 | 99.06 | 96.52 | 11.94 | 8.13 |
| ----- | ----- | 87898-3965 | ----- | ----- | ----- | 39 | ---- | 5 | 99.06 | 96.52 | 11.94 | 8.13 |
| ----- | ----- | 87898-3966 | ----- | ----- | ----- | 39 | ---- | 6 | 99.06 | 96.52 | 11.94 | 8.13 |

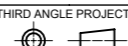
| | | | | | | | | | | | | |
|---|--|--------|------|---|--|---------|--------|---|--|----------------|----------|--------------|
| THIS DRAWING CONTAINS INFORMATION THAT IS PROPRIETARY TO MOLEX ELECTRONIC TECHNOLOGIES, LLC AND SHOULD NOT BE USED WITHOUT WRITTEN PERMISSION | | | | | | | | | | | | |
| DIMENSION UNITS | | SCALE | | CURRENT REV DESC: | | | |  | | | | |
| mm | | NTS | | | | | | | | | | |
| GENERAL TOLERANCES (UNLESS SPECIFIED) | | | | EC NO: 698212 DRWN: DANUSA 2022/03/03 CHK'D: DANUSA 2022/03/04 APPR: MRAMAKRISHNA 2022/03/04 | | | | CUSTOM HEADER 2.54MM PITCH SINGLE ROW SINGLE WAFER SMT HEADER | | | | |
| | | MM | INCH | | | | | | | | | |
| 4 PLACES | | ± | ± | INITIAL REVISION: DRWN: SKLIM01 2005/10/26 APPR: PTLIM 2005/11/07 | | | | DOCUMENT NUMBER | | DOC TYPE | DOC PART | REVISION |
| 3 PLACES | | ± | ± | | | | | SD-87898-003 | | PSD | 001 | C1 |
| 2 PLACES | | ± 0.2 | ± | DRAFT WHERE APPLICABLE MUST REMAIN WITHIN DIMENSIONS | | | | MATERIAL NUMBER | | CUSTOMER | | SHEET NUMBER |
| 1 PLACE | | ± | ± | | | | | SEE TABLE | | GENERAL MARKET | | 16 OF 17 |
| 0 PLACES | | ± | ± | THIRD ANGLE PROJECTION | | DRAWING | SERIES | CUSTOMER | | SHEET NUMBER | | |
| ANGULAR TOL | | ± 3.0° | |  | | A3-SIZE | 87898 | GENERAL MARKET | | 16 OF 17 | | |

9 8 7 6 5 4 3 2 1

| PACKAGING OPTION PART NO. | | | | | | CKT SIZE | VOID POSITION | PLATING TYPE | DIMENSION | | | |
|---------------------------|---------------|------------------|---------------|-------------------------|----------------------|----------|---------------|--------------|-----------|-------|-------|------|
| TRAY WITHOUT CAP | TRAY WITH CAP | TUBE WITHOUT CAP | TUBE WITH CAP | TAPE & REEL WITHOUT CAP | TAPE & REEL WITH CAP | | | | A | B | F | M |
| ----- | ----- | 87898-4061 | ----- | ----- | ----- | 40 | ---- | 1 | 101.6 | 99.06 | 11.94 | 8.13 |
| ----- | ----- | 87898-4062 | ----- | ----- | ----- | 40 | ---- | 2 | 101.6 | 99.06 | 11.94 | 8.13 |
| ----- | ----- | 87898-4064 | ----- | ----- | ----- | 40 | ---- | 4 | 101.6 | 99.06 | 11.94 | 8.13 |
| ----- | ----- | 87898-4065 | ----- | ----- | ----- | 40 | ---- | 5 | 101.6 | 99.06 | 11.94 | 8.13 |
| ----- | ----- | 87898-4066 | ----- | ----- | ----- | 40 | ---- | 6 | 101.6 | 99.06 | 11.94 | 8.13 |

E

E

D

D

C

C

B

B

A

A

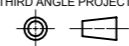
| | | | | | | | | | | | | | | |
|---|--|-------|--|--|--|---|--|--|--|---|-----------------|----------------|--------------|----------|
| THIS DRAWING CONTAINS INFORMATION THAT IS PROPRIETARY TO MOLEX ELECTRONIC TECHNOLOGIES, LLC AND SHOULD NOT BE USED WITHOUT WRITTEN PERMISSION | | | | | | | | | | | | | | |
| DIMENSION UNITS | | SCALE | | CURRENT REV DESC: | | | | | |  | | | | |
| mm | | NTS | | | | | | | | | | | | |
| GENERAL TOLERANCES (UNLESS SPECIFIED) | | | | EC NO: 698212 | | 2022/03/03 | | CUSTOM HEADER 2.54MM PITCH SINGLE ROW SINGLE WAFER SMT HEADER | | | | | | |
| | | | | DRWN: DANUSA | | 2022/03/04 | | | | | | | | |
| | | | | CHK'D: DANUSA | | 2022/03/04 | | PRODUCT CUSTOMER DRAWING | | | | | | |
| | | | | APPR: MRAMAKRISHNA | | 2022/03/04 | | | | | | | | |
| | | | | INITIAL REVISION: | | | | | | DOCUMENT NUMBER | | DOC TYPE | DOC PART | REVISION |
| | | | | DRWN: SKLIM01 | | 2005/10/26 | | SD-87898-003 | | PSD | 001 | C1 | | |
| | | | | APPR: PTLIM | | 2005/11/07 | | | | | | | | |
| ANGULAR TOL ± 3.0° | | | | DRAFT WHERE APPLICABLE MUST REMAIN WITHIN DIMENSIONS | | THIRD ANGLE PROJECTION | | DRAWING | | SERIES | MATERIAL NUMBER | CUSTOMER | SHEET NUMBER | |
| | | | | | |  | | A3-SIZE | | 87898 | SEE TABLE | GENERAL MARKET | 17 OF 17 | |

| | | | | |
|-----------------|----|--------------|------------|----------|
| DOCUMENT STATUS | P1 | RELEASE DATE | 2022/03/04 | 09:00:56 |
|-----------------|----|--------------|------------|----------|

9 8 7 6 5 4 3 2 1

FORMAT: Mel-lega-master-ib-prod-A3
REVISION: D
DATE: 2018/01/18