

## 50V, 200mA, Low-I<sub>Q</sub> 30μA Low-Dropout Linear Regulator with Enable

### DESCRIPTION

The TQL821CSV33 is a high-performance low dropout linear regulator for 3.3V with input range of 3V to 50V and low quiescent 30μA. TQL821CSV33 provides 2% output voltage accuracy and 200mA maximum driving current and is suitable for automotive or other supply systems. TQL821CSV33 just requires one small ceramic capacitor of 1μF to exhibit fast regulation and good stability. And it shows very low dropout voltage with 70mV in 100mA-load and 110mV in 200mA-load. The start operating voltage is 3V which is suitable to cranking condition of automotive system.

The device has an enable function to switch ON and OFF for power dissipation. And other protection functions such as thermal-shutdown and current-limit are against immediate damage.

### FEATURES

- AEC-Q100 qualified with the following results:
  - Device temperature grade 1: -40°C to 125°C
  - Device HBM ESD classification level H1C
  - Device CDM ESD classification level C3
- 3V to 50V Input Voltage Range
- 3.3V Fixed Output Voltage
- 70mV@100mA Low Dropout Voltage
- 200mA Output Current
- Typical 30μA Low Quiescent Current
- Typical ±2% Output Voltage Accuracy
- 1μF Ceramic Output Stable Capacitor
- Output Current Limit
- Over Temperature Protection
- RoHS Compliant
- Halogen-Free according to IEC 61249-2-21

### APPLICATION

- Automotive Power Supply Systems
- General Power Supply applications

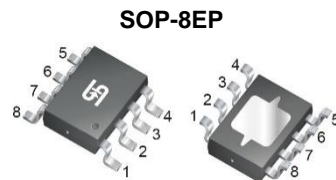

#### Pin Definition:

- |        |        |
|--------|--------|
| 1. IN  | 5. NC  |
| 2. EN  | 6. NC  |
| 3. NC  | 7. NC  |
| 4. GND | 8. OUT |

**Notes:** MSL 3 (Moisture Sensitivity Level) per J-STD-020

### TYPICAL APPLICATION CIRCUIT

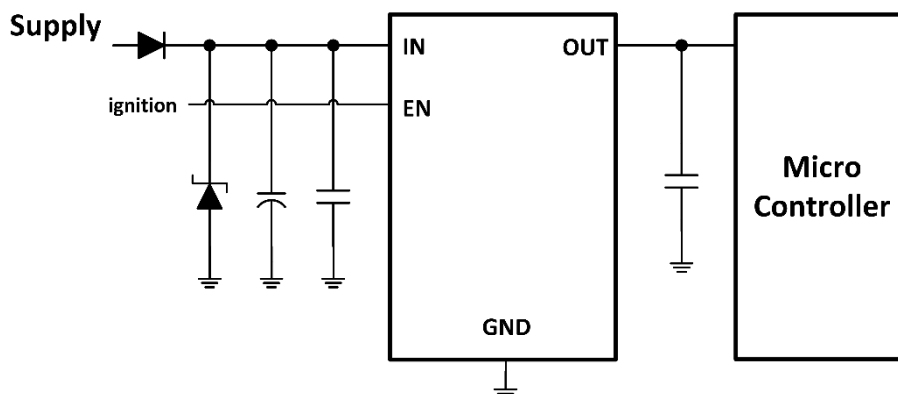

**ABSOLUTE MAXIMUM RATINGS** ( $T_A = 25^\circ\text{C}$  unless otherwise specified) (Note 1)

PARAMETER	SYMBOL	LIMIT	UNIT
Power Supply Pin	$V_{IN}$	55	V
EN Voltage to GND	$V_{EN}$	-0.3 to 55	V
OUT Voltage to GND	$V_{OUT}$	-0.3 to 7	V
Junction Temperature Range	$T_J$	-40 to +150	$^\circ\text{C}$
Storage Temperature Range	$T_{STG}$	-55 to +150	$^\circ\text{C}$
ESD Rating (Human Body Model) (Note 2)	HBM	$\pm 2$	kV
ESD Rating (Charged Device Model)	CDM	$\pm 1$	kV

**THERMAL PERFORMANCE**

PARAMETER	SYMBOL	TYP	UNIT
Junction to Case Thermal Resistance	$R_{\theta JC}$	11	$^\circ\text{C/W}$
Junction to Ambient Thermal Resistance	$R_{\theta JA}$	43	$^\circ\text{C/W}$

**Notes:** The thermal data is based on the PCB JESD 51-3 at natural convection on 1s0p board with 1 copper layer (1 x 70 $\mu\text{m}$  Cu) and with 300mm<sup>2</sup> heatsink area on PCB

**RECOMMENDED OPERATING CONDITIONS** (Note 3)

PARAMETER	SYMBOL	CONDITIONS	UNIT
Power Supply Pin	$V_{IN}$	$V_{OUT} + V_{dr}$ to 50	V
Extended Power Supply Pin	$V_{IN,ext}$	3 to 50	V
EN Voltage to GND	$V_{EN}$	0 to 50	V
Output Stable Capacitor	$C_{OUT}$	$\geq 1$	$\mu\text{F}$
ESR of Output Capacitor	ESR	$\leq 100$	$\Omega$
Operating Junction Temperature Range	$T_J$	-40 to +150	$^\circ\text{C}$
Operating Ambient Temperature Range	$T_{OPA}$	-40 to +125	$^\circ\text{C}$

**ELECTRICAL SPECIFICATIONS** ( $V_{IN} = 13.5\text{V}$ ,  $T_J = -40$  to  $150^\circ\text{C}$  unless otherwise noted)

PARAMETER	CONDITIONS	SYMBOL	MIN	TYP	MAX	UNIT
<b>Supply Voltage</b>						
Output Voltage	$0.05\text{mA} < I_{OUT} < 200\text{mA}$ $3.72\text{V} < V_{IN} < 28\text{V}$	$V_{OUT}$	3.23	3.3	3.37	V
Output Voltage	$0.05\text{mA} < I_{OUT} < 100\text{mA}$ $3.55\text{V} < V_{IN} < 40\text{V}$	$V_{OUT}$	3.23	3.3	3.37	V
Start-up Slew-rate	$V_{IN} > 18\text{V/ms}$ $C_{OUT} = 1\mu\text{F}$ $0.33\text{V} < V_{OUT} < 2.97\text{V}$	$dV_{OUT}/dt$	--	35	--	V/ms
Current Limit	$0\text{V} < V_{OUT} < 3.1\text{V}$	$I_{lim}$	--	320	--	mA
Load Regulation	$I_{OUT} = 0.05$ to $200\text{mA}$ $V_{IN} = 6\text{V}$	$\Delta V_{OUT,lo}$	-15	-1.5	+15	mV

<b>ELECTRICAL SPECIFICATIONS</b> ( $V_{IN} = 13.5V$ , $T_J = -40$ to $150^{\circ}C$ unless otherwise noted)						
PARAMETER	CONDITIONS	SYMBOL	MIN	TYP	MAX	UNIT
<b>Supply Voltage</b>						
Line Regulation	$V_{IN} = 8$ to $32V$ $I_{OUT} = 1mA$	$\Delta V_{OUT,li}$	-15	0	15	mV
Dropout Voltage ( $V_{dr}=V_{IN}-V_{OUT}$ )	$I_{OUT} = 200mA$	$V_{dr}$	--	140	340	mV
Dropout Voltage ( $V_{dr}=V_{IN}-V_{OUT}$ )	$I_{OUT} = 100mA$	$V_{dr}$	--	70	170	mV
Power Supply Ripple Rejection	$f = 100Hz$ , $V = 0.5V_{pp}$	PSRR	--	59	--	dB
Thermal Shutdown Threshold (Note 4)		$T_{th}$	151	--	200	$^{\circ}C$
Thermal Shutdown Hysteresis (Note 4)		$T_{hy}$	--	30	--	$^{\circ}C$
<b>Current Consumption</b>						
Standby Current ( $I_o=I_{IN}$ )	$V_{EN} = 0V$ , $T_J < 105^{\circ}C$	$I_{o,st}$	--	1.3	5	$\mu A$
Standby Current ( $I_o=I_{IN}$ )	$V_{EN} = 0.4V$ , $T_J < 125^{\circ}C$	$I_{o,st}$	--	--	8	$\mu A$
Quiescent Current ( $I_o=I_{IN}-I_{OUT}$ )	$I_{OUT} = 0.05mA$ , $T_J = 25^{\circ}C$	$I_o$	--	30	52	$\mu A$
Quiescent Current ( $I_o=I_{IN}-I_{OUT}$ )	$I_{OUT} = 0.05mA$ , $T_J < 125^{\circ}C$	$I_o$		62	77	$\mu A$
<b>Enable</b>						
High Level Input Voltage		$V_{ENH}$	2	--	--	V
Low Level Input Voltage	$V_{OUT} \leq 0.1V$	$V_{ENL}$	--	--	0.8	V
Threshold Hysteresis		$V_{ENHy}$	100	--	--	mV
EN Input Current	$V_{EN} = 3.3V$	$I_{EN}$	--	--	3.5	$\mu A$
EN Input Current	$V_{EN} \leq 18V$	$I_{EN}$	--	--	22	$\mu A$
EN Pull-down Resistor		$R_{EN}$	0.95	1.5	2.6	m $\Omega$

**Note:**

1. Stresses listed as the above "Absolute Maximum Ratings" may cause permanent damage to the device. These are for stress ratings. Functional operation of the device at these or any other conditions beyond those indicated in the operational sections of the specifications is not implied. Exposure to absolute maximum rating conditions for extended periods may remain possibility to affect device reliability.
2. Devices are ESD sensitive. Handling precaution recommended.
3. The device is not guaranteed to function outside its operating conditions.
4. Guaranteed by design.

**ORDERING INFORMATION**

ORDERING CODE	PACKAGE	PACKING
TQL821CSV33 RLG	SOP-8EP	2,500pcs / 13" Reel

**BLOCK DIAGRAM**

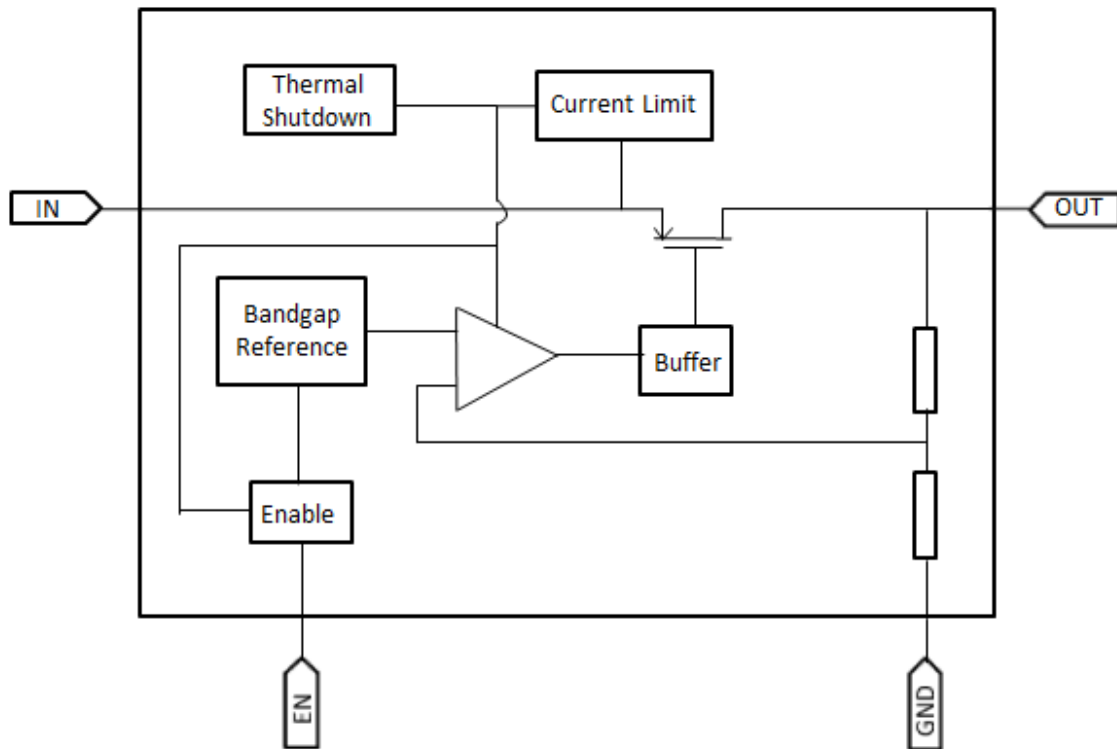

**PIN DESCRIPTION**

PIN NO.	NAME	FUNCTION
1	IN	Power supply pin for system
2	EN	Enable system function
3	NC	Not connected
4	GND	Ground
5	NC	Not connected
6	NC	Not connected
7	NC	Not connected
8	OUT	Output supply voltage
Pad	--	Connect to GND

## **APPLICATION INFORMATION**

TQL821CSV33 is a high performance low dropout voltage regulator. The device operates with a wide input voltage from 3V to 50V and up to 200mA of output current. It also provides a high accuracy output voltage for  $\pm 2\%$  in all the load and line regulation.

### **Enable**

The EN pin is high voltage tolerant pin. High input enables the device ON and low is disable which can be connected to microcontroller or digital control system. It can be connected to input power pin directly.

### **Thermal Shutdown (TSD)**

Internal 160°C comparator will trigger temperature protection (TSD). TSD will shut down system, until internal temperature back to 130°C.

### **Current Limit**

The TQL821CSV33 features Current Limit function to protect device from damage by excessive power dissipation such as OUT shorted to GND. It limits output current to maintain power dissipation in the safe region.

**TYPICAL OPERATING CHARACTERISTICS**

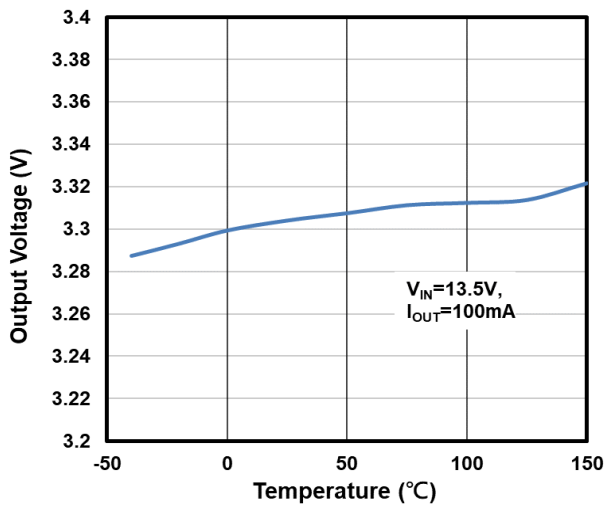

Figure 1. Output Voltage vs. Junction Temperature

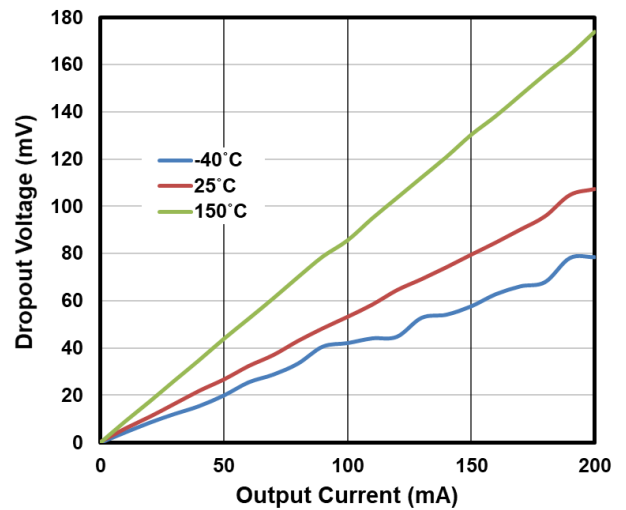

Figure 2. Dropout Voltage vs. Output Current

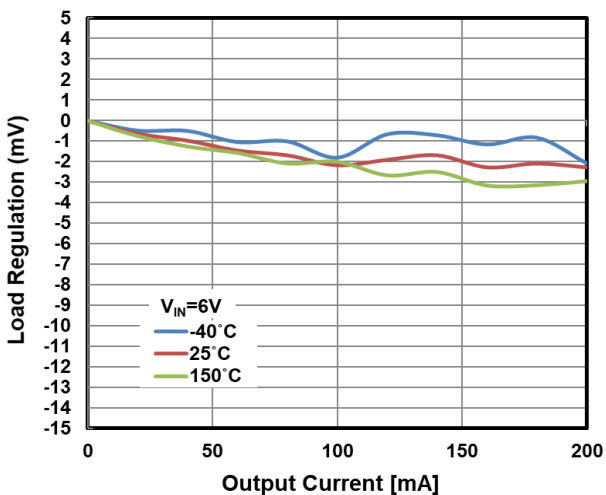

Figure 3. Load Regulation vs. Output Current

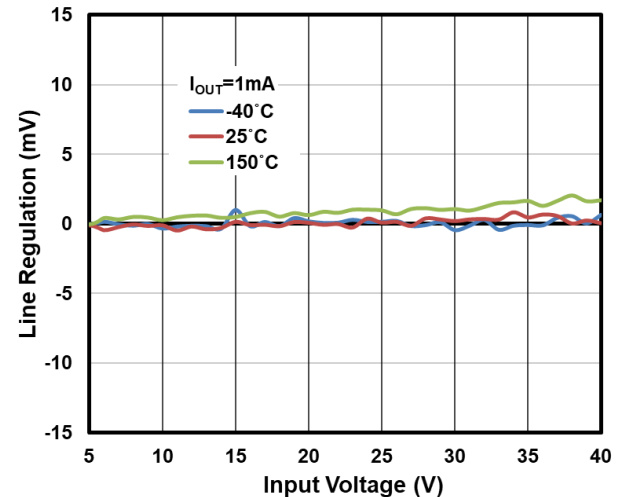

Figure 4. Line Regulation vs. Input Voltage

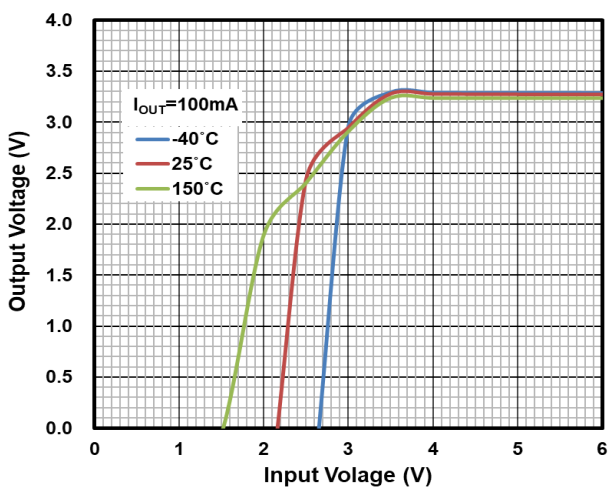

Figure 5. Output Voltage vs. Input Voltage

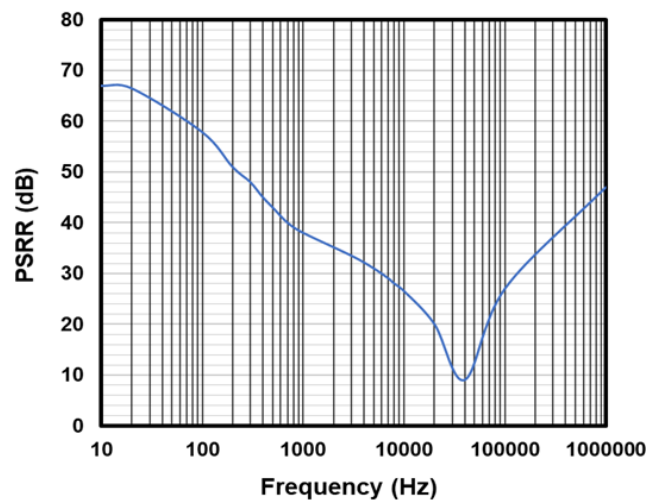
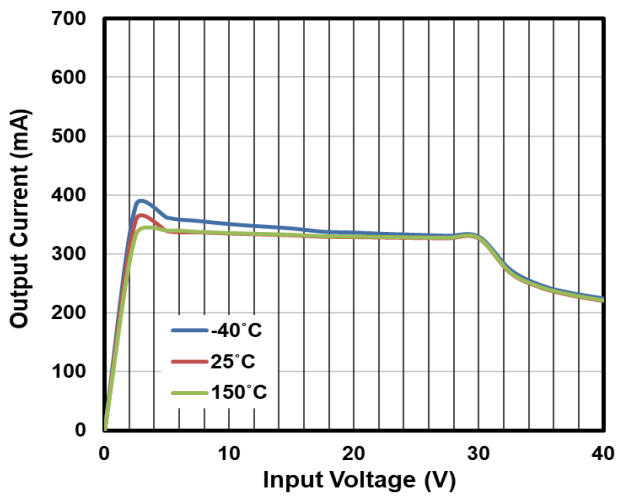
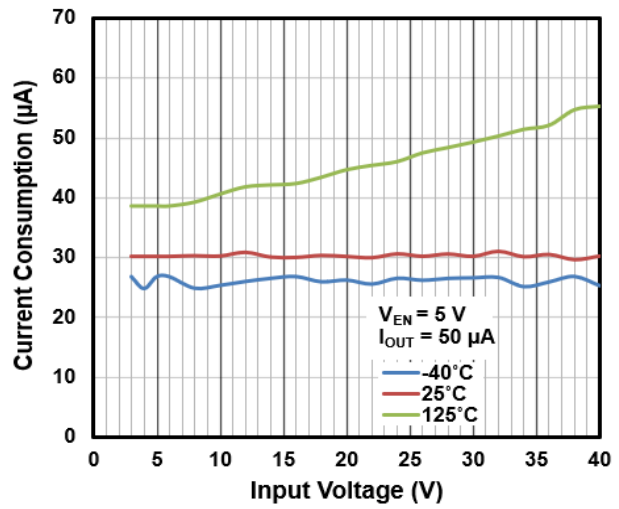

Figure 6. Ripple Rejection vs. Frequency

**TYPICAL OPERATING CHARACTERISTICS (CONTINUE)**



**Figure 7. Output Current vs. Input Voltage**



**Figure 8. Current Consumption vs. Input Voltage**

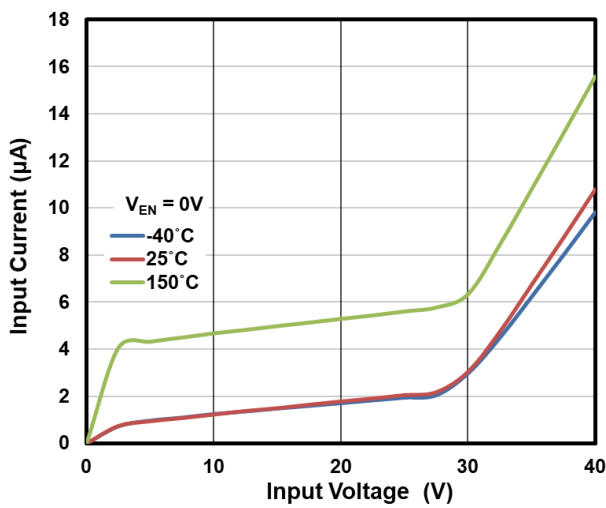

**Figure 9. Input Current vs. Input Voltage**

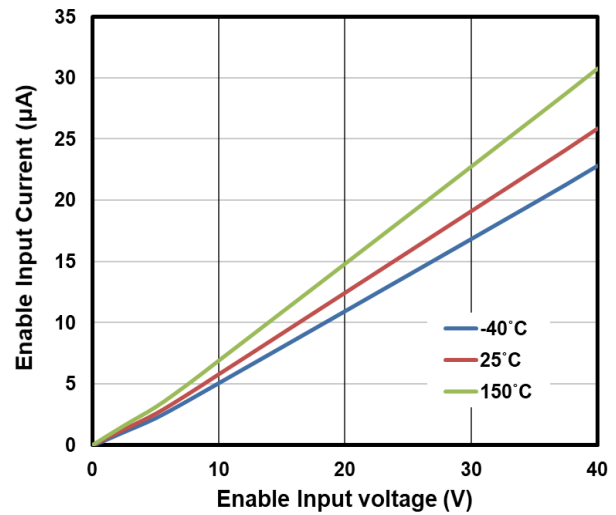

**Figure 10. Enabled Input Current vs. Enabled Input Voltage**

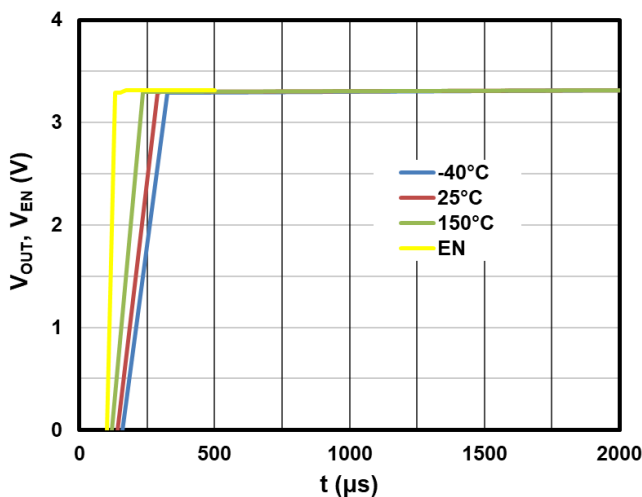

**Figure 11. Output Voltage vs. time (EN switched ON)**

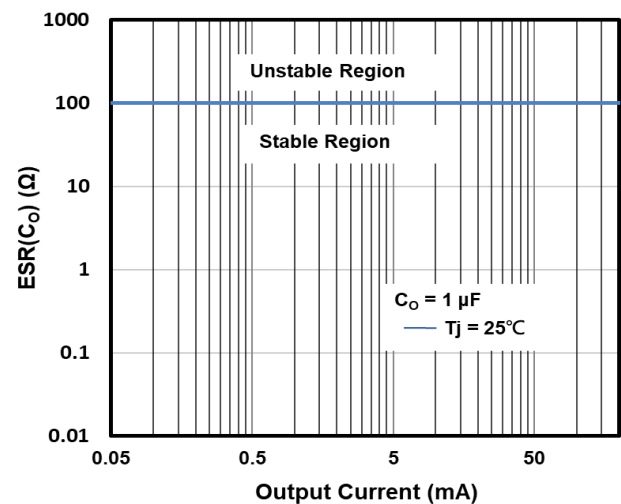

**Figure 12. Output Capacitor Series Resistor  $ESR(C_0)$  vs. Output Current**

**PACKAGE OUTLINE DIMENSIONS**

**SOP-8EP**

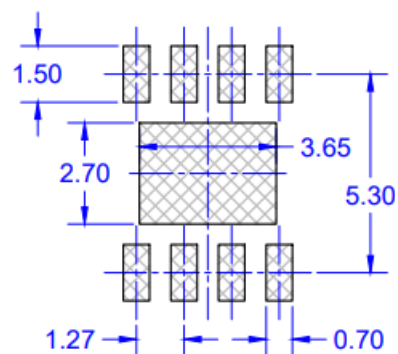
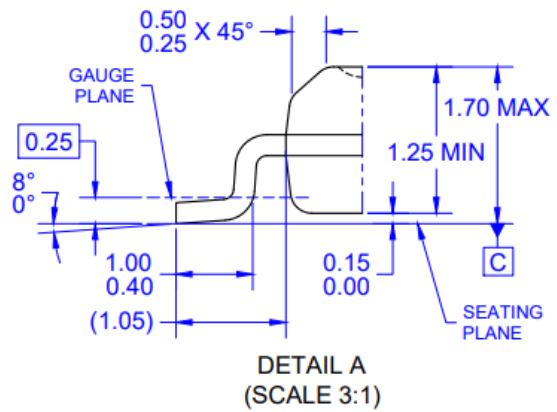
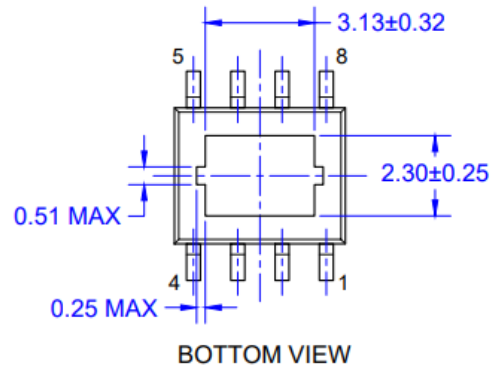
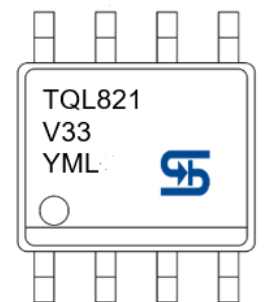
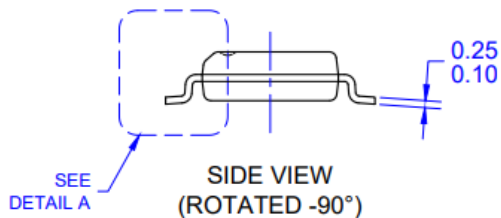
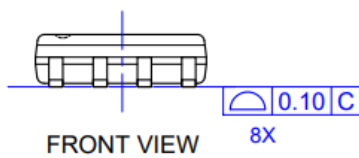
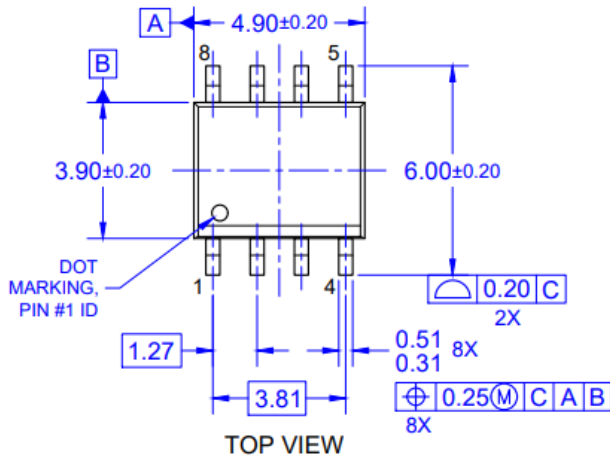

- Y** = Year Code
- M** = Month Code for Halogen Free Product
  - O** =Jan **P** =Feb **Q** =Mar **R** =Apr
  - S** =May **T** =Jun **U** =Jul **V** =Aug
  - W** =Sep **X** =Oct **Y** =Nov **Z** =Dec
- L** = Lot Code (1~9, A~Z)

**NOTES: UNLESS OTHERWISE SPECIFIED**

1. ALL DIMENSIONS ARE IN MILLIMETERS.
2. DIMENSIONING AND TOLERANCING PER ASME Y14.5M-1994.
3. PACKAGE OUTLINE REFERENCE: JEDEC MS-012, ISSUE G, VARIATION BA.
4. MOLDED PLASTIC BODY DIMENSIONS DO NOT INCLUDE MOLD FLASH, PROTRUSIONS OR GATE BURRS.
5. DWG NO REF: HQ2SD07-030 REV A.



## Notice

Specifications of the products displayed herein are subject to change without notice. TSC or anyone on its behalf, assumes no responsibility or liability for any errors or inaccuracies.

Purchasers are solely responsible for the choice, selection, and use of TSC products and TSC assumes no liability for application assistance or the design of Purchasers' products.

Information contained herein is intended to provide a product description only. No license, express or implied, to any intellectual property rights is granted by this document. Except as provided in TSC's terms and conditions of sale for such products, TSC assumes no liability whatsoever, and disclaims any express or implied warranty, relating to sale and/or use of TSC products including liability or warranties relating to fitness for a particular purpose, merchantability, or infringement of any patent, copyright, or other intellectual property right.

The products shown herein are not designed for use in medical, life-saving, or life-sustaining applications. Customers using or selling these products for use in such applications do so at their own risk and agree to fully indemnify TSC for any damages resulting from such improper use or sale.