

PAGE 1/2

ISSUE 22-03-22

SERIE : DPDT

PART NUMBER : R577F13100

RF CHARACTERISTICS

Frequency range : **0 - 26.5 GHz**
Impedance : **50 Ohms**

Frequency (GHz)	DC - 3	3 - 8	8 - 12.4	12.4 - 18	18 - 26.5
VSWR max	1.20	1.30	1.40	1.50	1.70
Insertion loss max	0.20 dB	0.30 dB	0.40 dB	0.50 dB	0.70 dB
Isolation min	80 dB	70 dB	65 dB	60 dB	50 dB
Average power (*)	240 W	150 W	120 W	100 W	40 W

ELECTRICAL CHARACTERISTICS

Actuator : **FAILSAFE**
Nominal current ** : **140 mA**
Actuator voltage (Vcc) : **28V (24 to 30V)**
Terminals : **solder pins (250°C max. / 30 sec.)**
TTL inputs (E) - High level : **2.2 to 5.5 V / 800µA at 5.5 V**
- Low level : **0 to 0.8 V / 20µA at 0.8 V**

MECHANICAL CHARACTERISTICS

Connectors : **SMA female per MIL-C 39012**
Life : **2.5 million cycles**
Switching Time*** : **< 15 ms**
Construction : **Splashproof**
Weight : **< 100 g**

ENVIRONMENTAL CHARACTERISTICS

Operating temperature range : **-40°C to +85°C**
Storage temperature range : **-55°C to +85°C**

(* Average power at 25°C per RF Path)

(** At 25° C ±10%)

(*** Nominal voltage ; 25° C)



PAGE 2/2

ISSUE 22-03-22

SERIE : DPDT

PART NUMBER : R577F13100

DRAWING

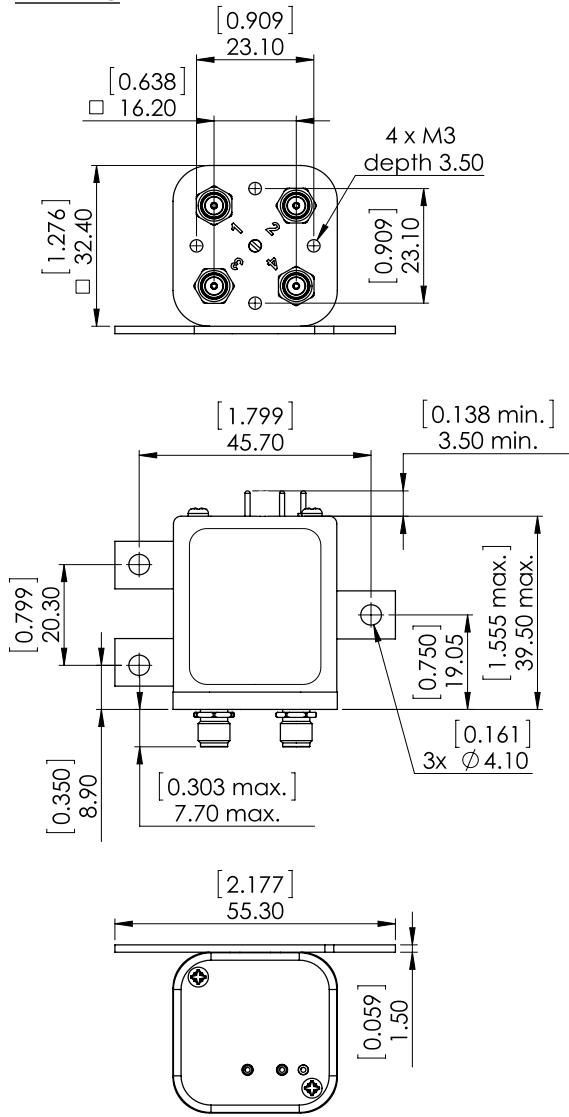

General tolerances : ±0,5 mm [0,02 in]



LABEL

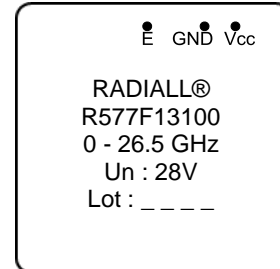

SCHEMATIC DIAGRAM

Position : De energized

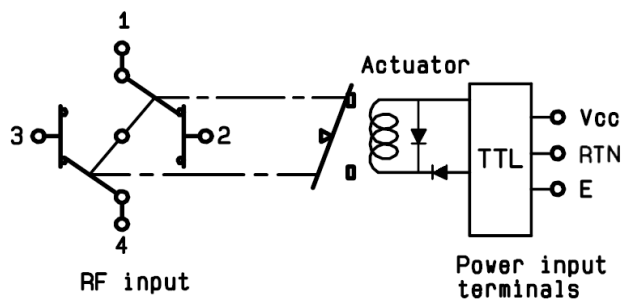

TTL input	RF Continuity
E = 1	1 ↔ 3 / 2 ↔ 4
E = 0	1 ↔ 2 / 3 ↔ 4