

1.58 MIN  
(PCB THICKNESS)

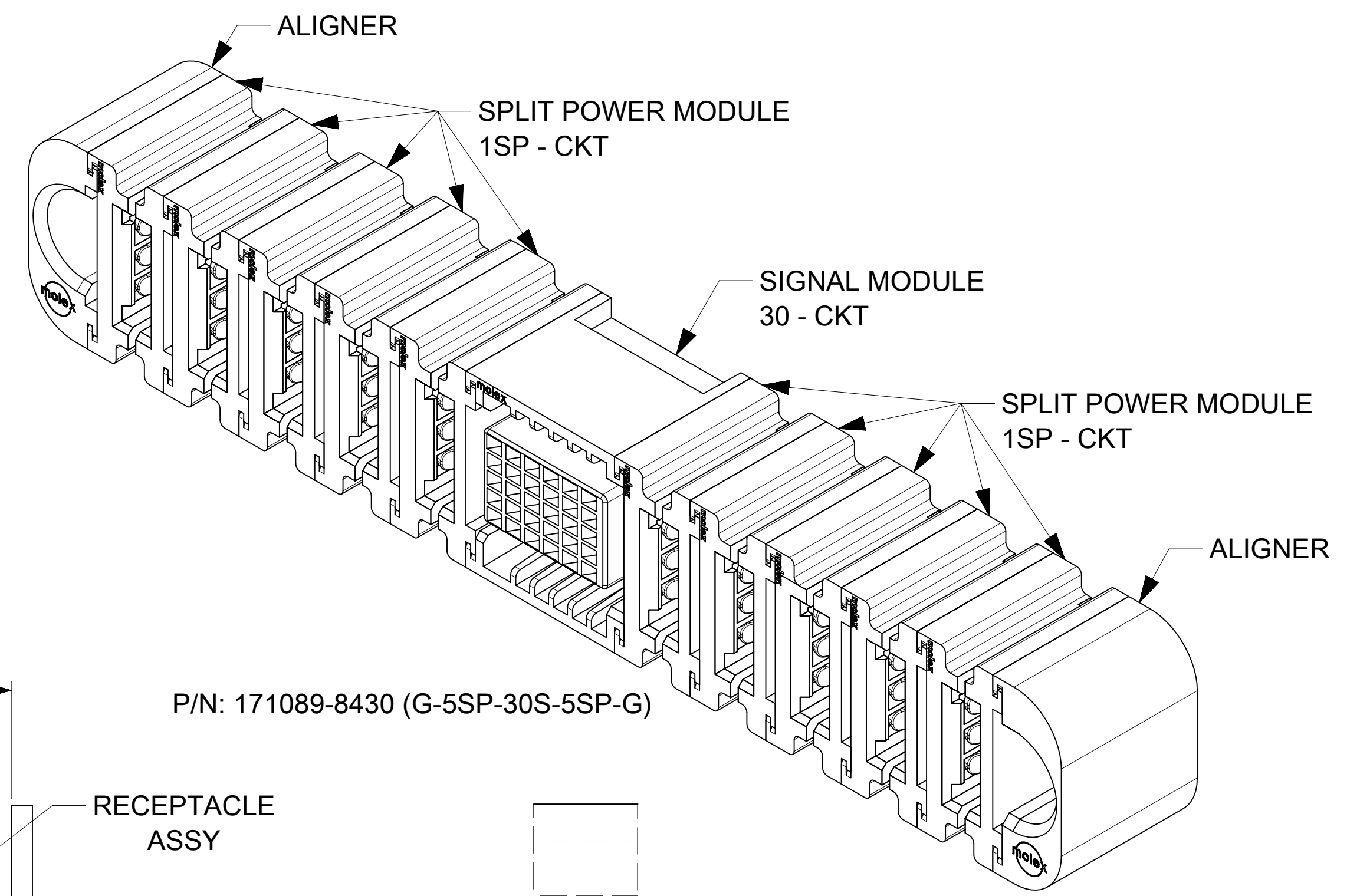

P/N: 171089-8430 (G-5SP-30S-5SP-G)

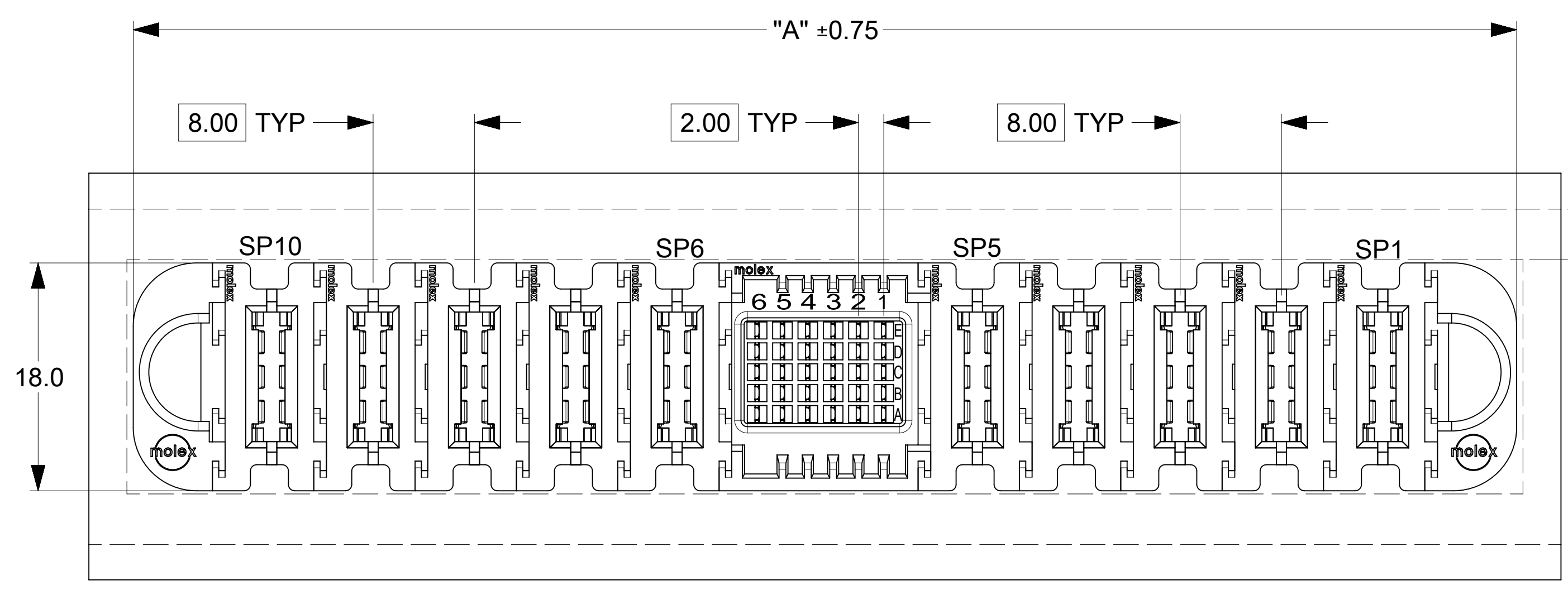

ALLOW EXTRA SPACE  
4.00 MM PER SIDE  
(REQUIRED FOR RE-WORK PER AS-46436-100)

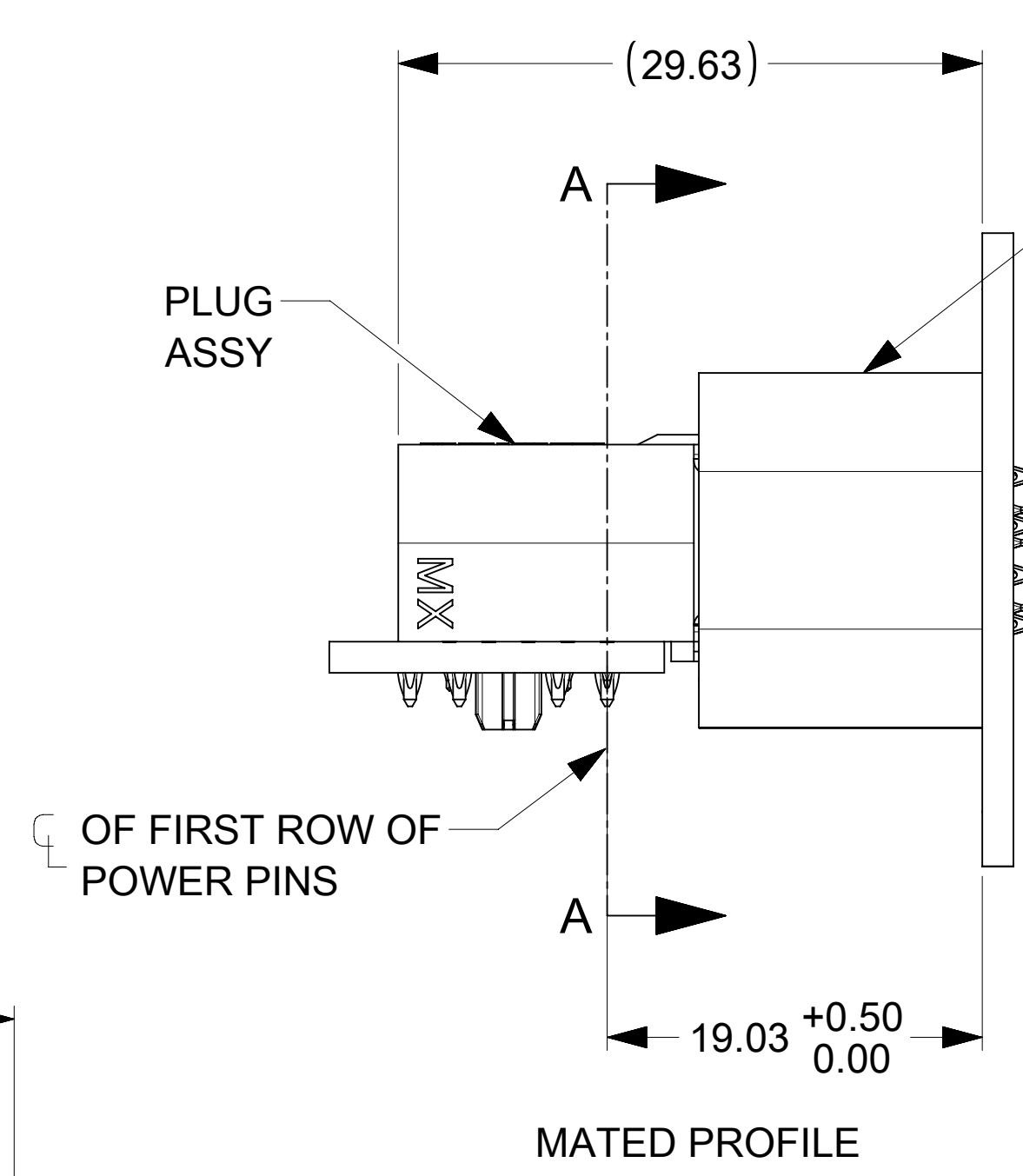

RECEPTACLE  
ASSY

RECEPTACLE  
SIDE PCB

0.88 ± 0.15

PLUG SIDE  
PCB

PARTIAL OF A-A  
(POWER CKTS ARE ALIGNED)

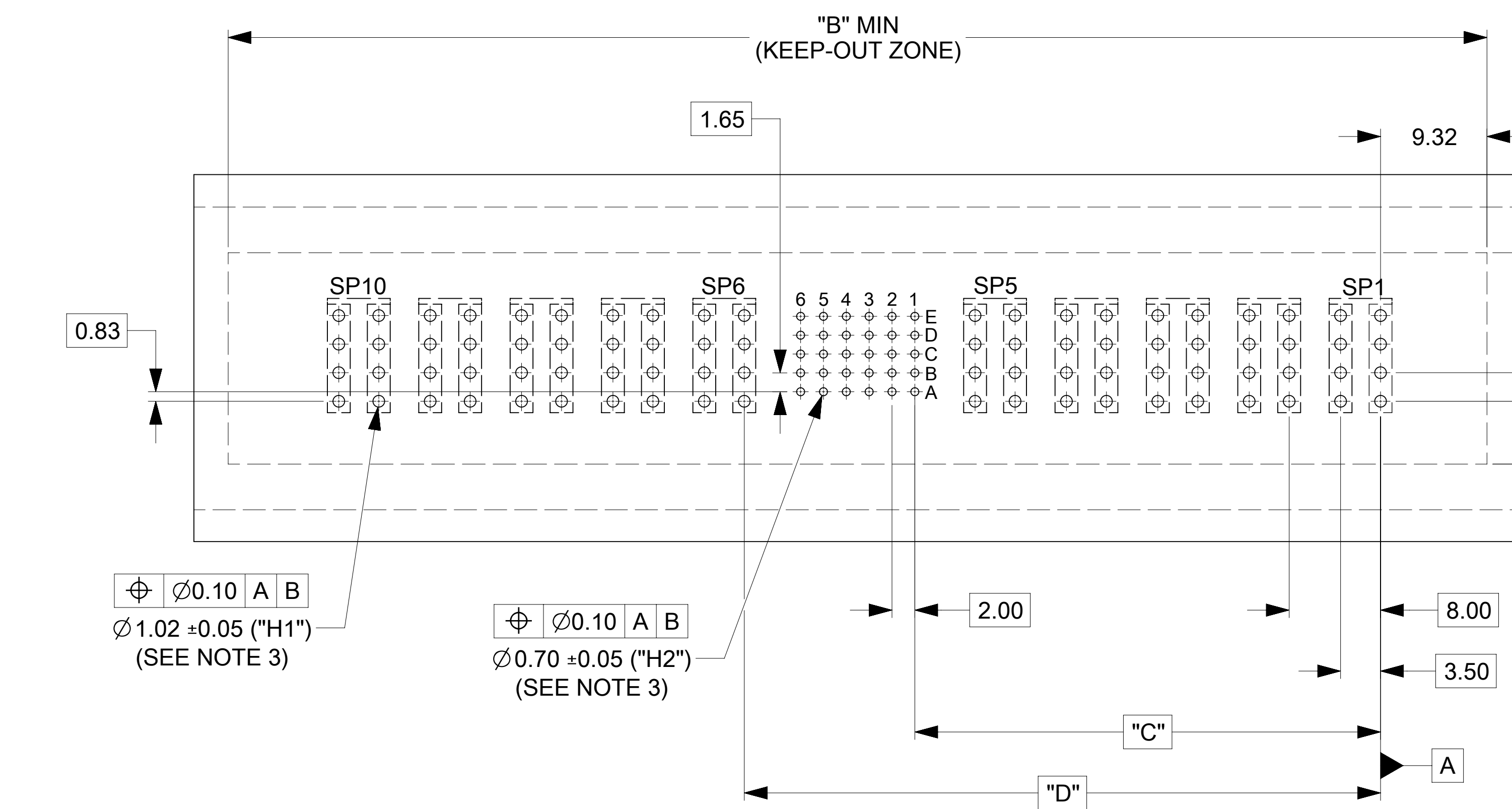

OF FIRST ROW OF  
POWER PINS

MATED PROFILE

NOTES:

- MATERIAL:
  - HOUSINGS: LCP UL94, V-0, COLOR: BLACK
  - TERMINALS: HIGH CONDUCTIVITY COPPER ALLOY
  - PLATING: 1.27 MICROMETER (50 MICROINCH) NICKEL OVERALL WITH 2.54 MICROMETER (100 MICROINCH) SELECTIVE TIN ON TAILS AND 0.762 MICROMETER (30 MICROINCH) SELECTIVE GOLD ON CONTACT AREA
- PACKAGING: ASSEMBLIES TO BE TRAY PACKED PER PACKAGING SPEC: 1710891001-PK
- PLATED THRU HOLE SIZE, REFER TO PS-171088-0000 FOR DETAILS
- PRODUCT SPEC: PS-171088-0000
- APPLICATION SPEC: AS-46436-100
- PRODUCT TO MEET RoHS REQUIREMENTS
- ASSEMBLY MATES TO MOLEX PLUG ASSEMBLY P/N 171088-\*\*\*\* (SEE TABLE IN SHEET 2)
- TAIL DESIGN: COMPLIANT PINS
- POWER AND SIGNAL CONTACTS ARE LUBRICATED.
- MOLEX LOGO TO BE LOCATED APPROXIMATELY AS SHOWN.

RECOMMENDED PCB LAYOUT AND KEEP-OUT ZONE FOR G-(1SP TO 5SP)-30S-(1SP TO 5SP)-G

THIS DRAWING CONTAINS INFORMATION THAT IS PROPRIETARY TO MOLEX ELECTRONIC TECHNOLOGIES, LLC AND SHOULD NOT BE USED WITHOUT WRITTEN PERMISSION									
DIMENSION UNITS	SCALE	CURRENT REV DESC: ADDED ISO VIEWS							
mm	3:1								
GENERAL TOLERANCES (UNLESS SPECIFIED)									
ANGULAR TOL	± 0.5°								
4 PLACES	±	EC NO: 689821							
3 PLACES	±	DRWN: KSUTAR	2021/12/16						
2 PLACES	± 0.13	CHK'D: GJEEVANSURES	2021/12/22						
1 PLACE	± 0.25	APPR: HTHYAGARAJ	2022/02/14						
0 PLACES	±	INITIAL REVISION:							
DRAFT WHERE APPLICABLE MUST REMAIN WITHIN DIMENSIONS		DRWN: KSUTAR	2021/09/29						
		APPR: HTHYAGARAJ	2021/11/08						
THIRD ANGLE PROJECTION		DRAWING	SERIES	MATERIAL NUMBER	CUSTOMER	SHEET NUMBER			
D-SIZE		171089	SEE TABLE	GENERAL MARKET	1 OF 4				



G-\*SP-\*S-\*SP-G  
VERT RECEPTACLE ASSY - TEN60 SPLIT POWER

PRODUCT CUSTOMER DRAWING

DOCUMENT NUMBER	DOC TYPE	DOC PART	REVISION
1710898430	PSD	000	A1

DOCUMENT STATUS	P1	RELEASE DATE	2022/02/14 09:02:27
-----------------	----	--------------	---------------------

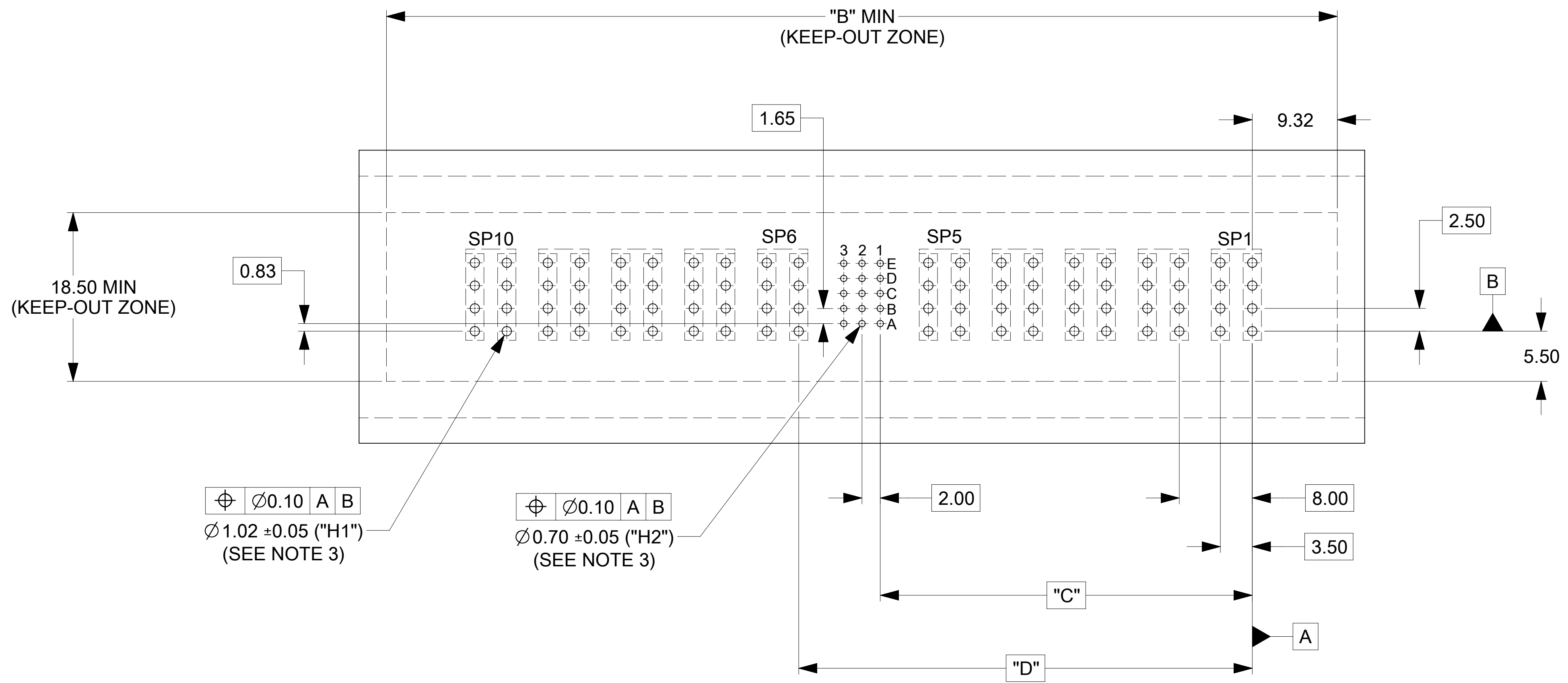

RECOMMENDED PCB LAYOUT AND KEEP-OUT ZONE FOR G-(1SP TO 5SP)-15S-(1SP TO 5SP)-G

REFER TO BELOW TABLE FOR DIMENSIONS.

FG P/N	CONFIGURATION	POWER CKT SIZE	SIGNAL CKT SIZE	DIM "A" (IN MM)	DIM "B" (IN MM)	DIM "C" (IN MM)	DIM "D" (IN MM)	HOLES COUNT "H1"	HOLES COUNT "H2"	MATES WITH R/A PLUG ASSY P/N
1710898421	G-1SP-15S-1SP-G	1	15	39.21	40.21	8.78	17.71	16	15	1710888421
1710898422	G-2SP-15S-2SP-G	2	15	55.21	56.21	16.78	25.71	32	15	1710888422
1710898423	G-3SP-15S-3SP-G	3	15	71.21	72.21	24.78	33.71	48	15	1710888423
1710898424	G-4SP-15S-4SP-G	4	15	87.21	88.21	32.78	41.71	64	15	1710888424
1710898425	G-5SP-15S-5SP-G	5	15	103.21	104.21	40.78	49.71	80	15	1710888425
1710898426	G-1SP-30S-1SP-G	1	30	45.21	46.21	8.78	23.71	16	30	1710888426
1710898427	G-2SP-30S-2SP-G	2	30	61.21	62.21	16.78	31.71	32	30	1710888427
1710898428	G-3SP-30S-3SP-G	3	30	77.21	78.21	24.78	39.71	48	30	1710888428
1710898429	G-4SP-30S-4SP-G	4	30	93.21	94.21	32.78	47.71	64	30	1710888429
1710898430	G-5SP-30S-5SP-G	5	30	109.21	110.21	40.78	55.71	80	30	1710888430

THIS DRAWING CONTAINS INFORMATION THAT IS PROPRIETARY TO MOLEX ELECTRONIC TECHNOLOGIES, LLC AND SHOULD NOT BE USED WITHOUT WRITTEN PERMISSION

DIMENSION UNITS <b>mm</b>	SCALE <b>3:1</b>	CURRENT REV DESC: ADDED ISO VIEWS	
GENERAL TOLERANCES (UNLESS SPECIFIED)		EC NO: 689821	
ANGULAR TOL	± 0.5°	DRWN: KSUTAR	2021/12/16
4 PLACES	±	CHK'D: GJEEVANSURES	2021/12/22
3 PLACES	±	APPR: HTHYAGARAJ	2022/02/14
2 PLACES	± 0.13	INITIAL REVISION:	
1 PLACE	± 0.25	DRWN: KSUTAR	2021/09/29
0 PLACES	±	APPR: HTHYAGARAJ	2021/11/08
DRAFT WHERE APPLICABLE MUST REMAIN WITHIN DIMENSIONS		THIRD ANGLE PROJECTION	DRAWING
			<b>D-SIZE</b>
		SERIES	<b>171089</b>
		MATERIAL NUMBER	SEE TABLE
		CUSTOMER	GENERAL MARKET
		DOCUMENT NUMBER	<b>1710898430</b>
		DOC TYPE	PSD
		DOC PART	000
		REVISION	<b>A1</b>
		SHEET NUMBER	2 OF 4

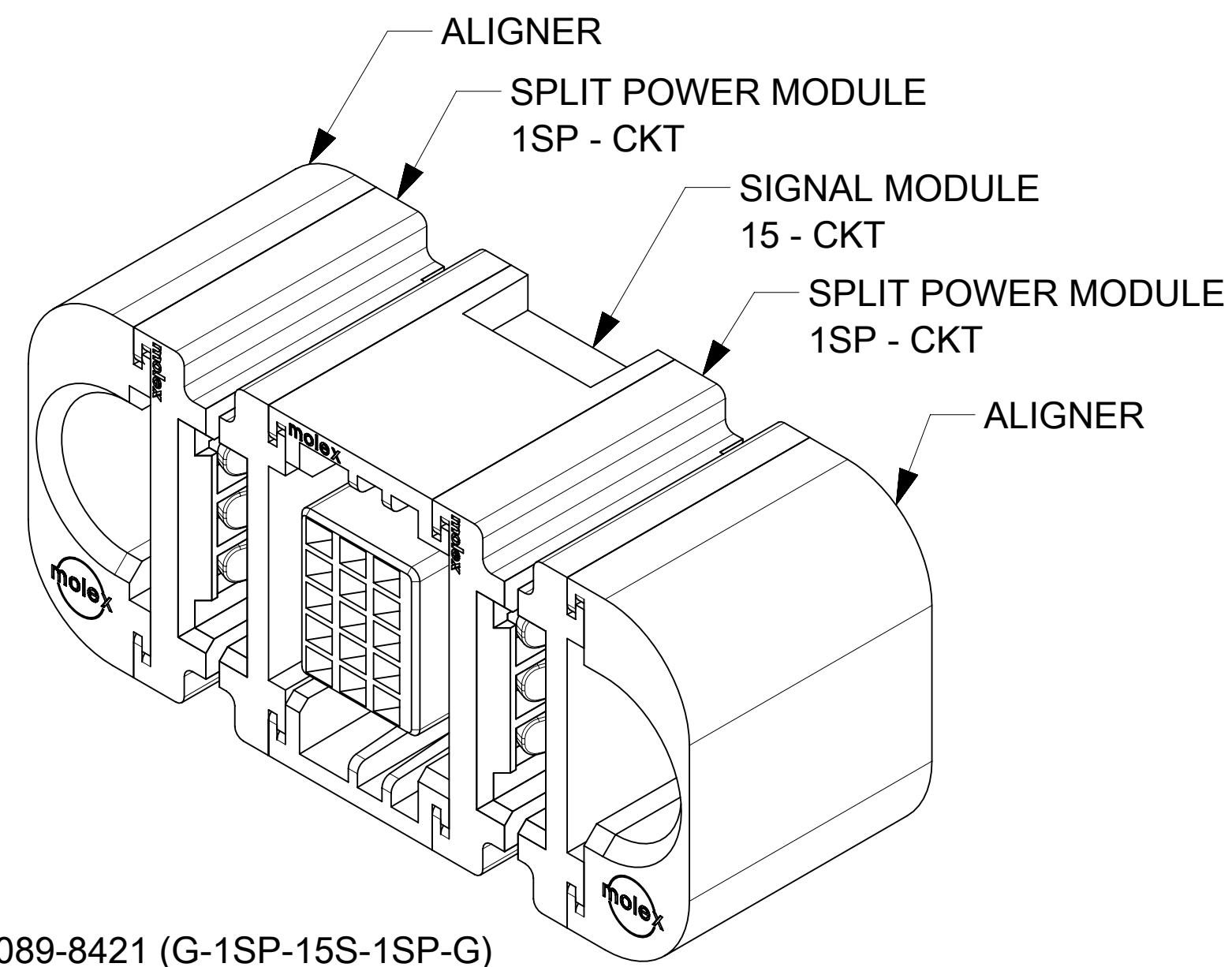

P/N: 171089-8421 (G-1SP-15S-1SP-G)

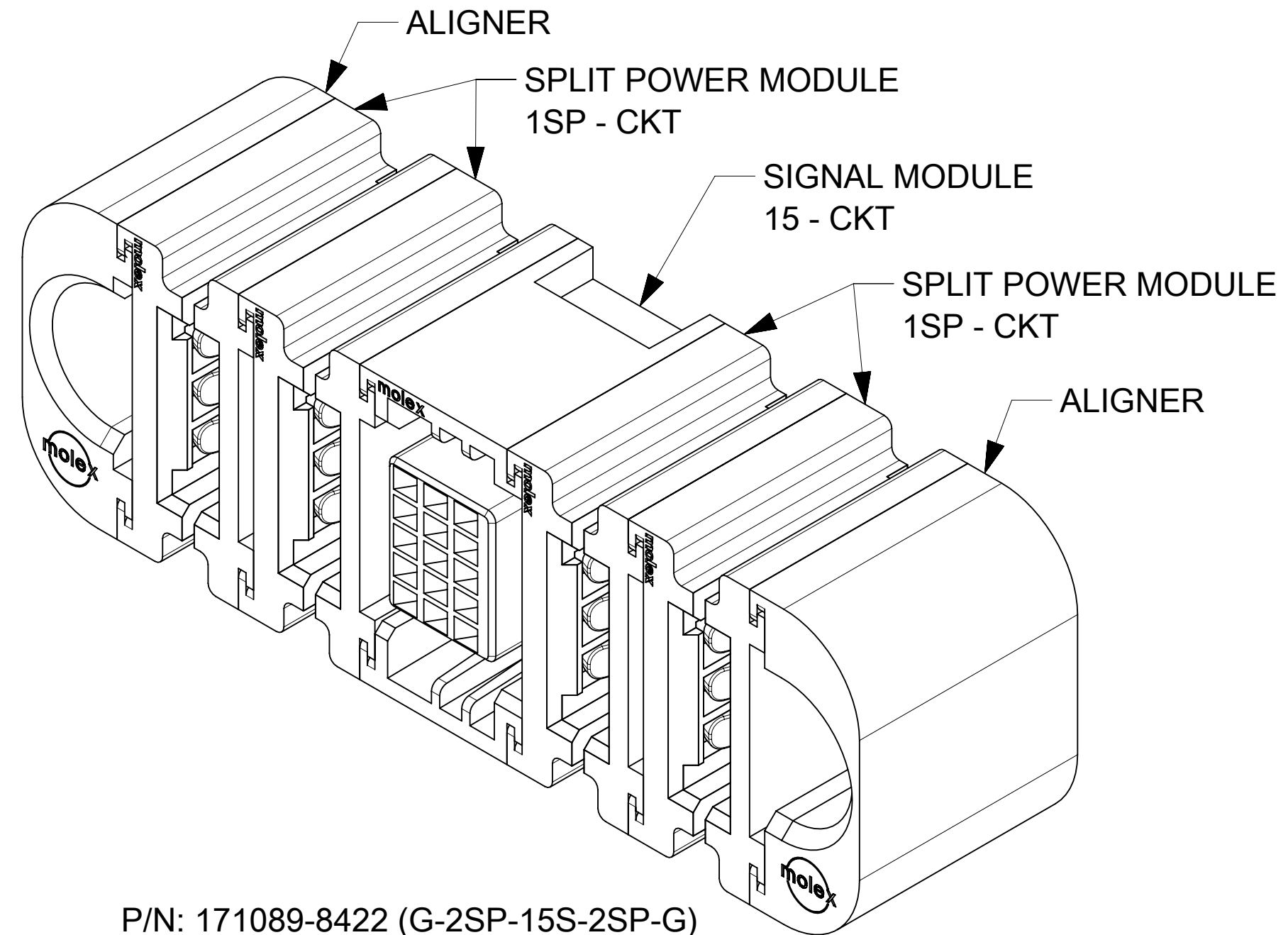

P/N: 171089-8422 (G-2SP-15S-2SP-G)

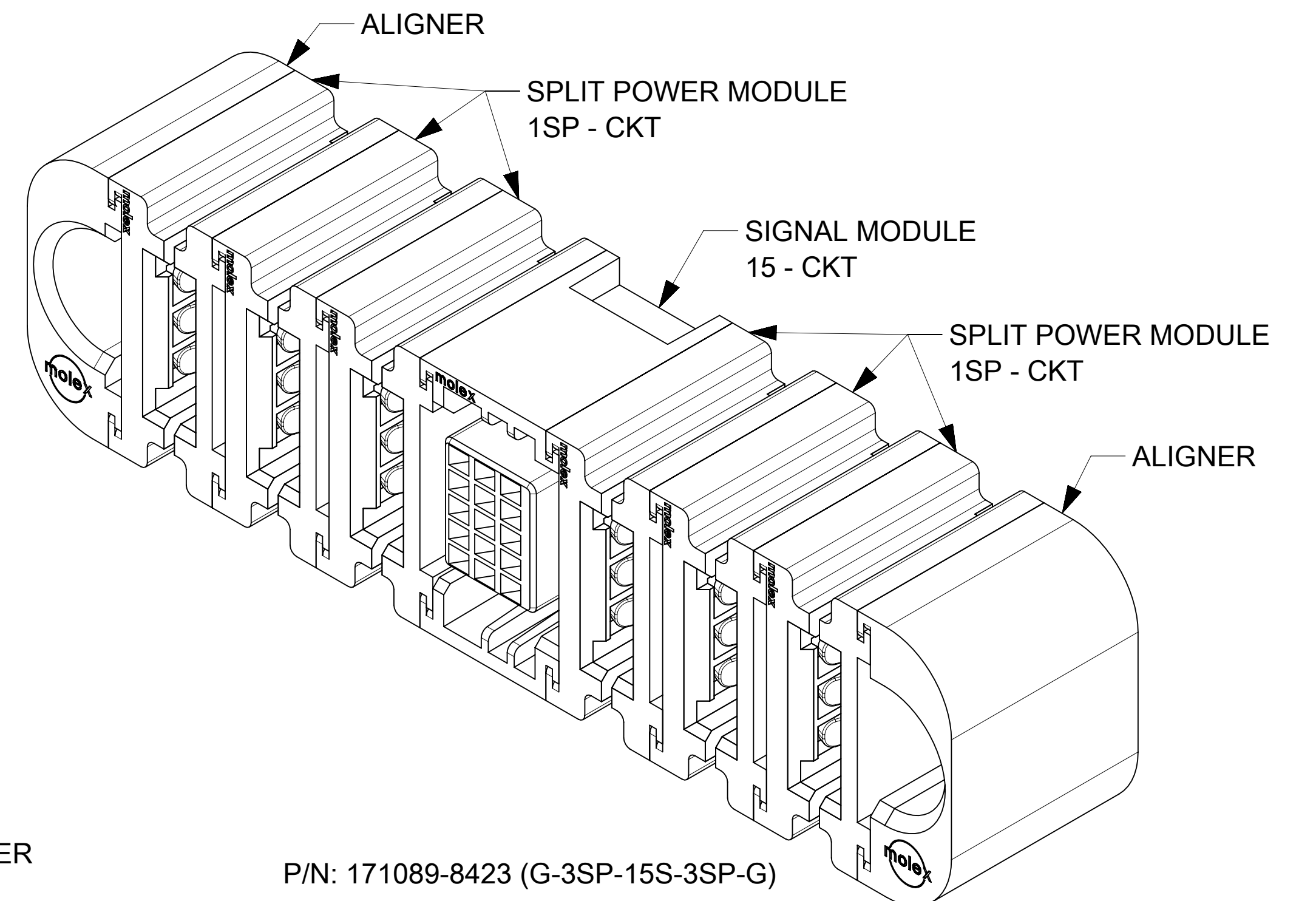

P/N: 171089-8423 (G-3SP-15S-3SP-G)

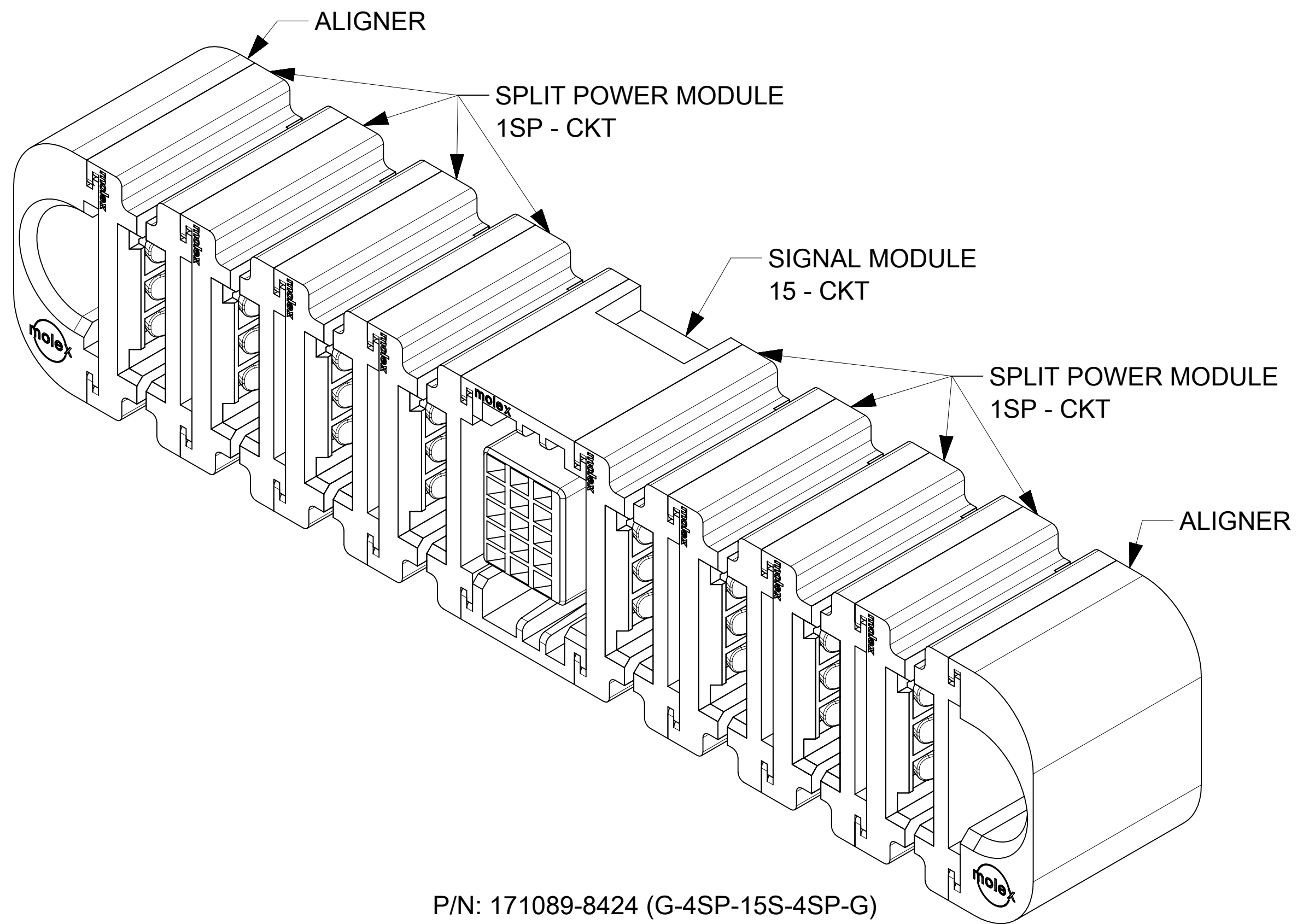

P/N: 171089-8424 (G-4SP-15S-4SP-G)

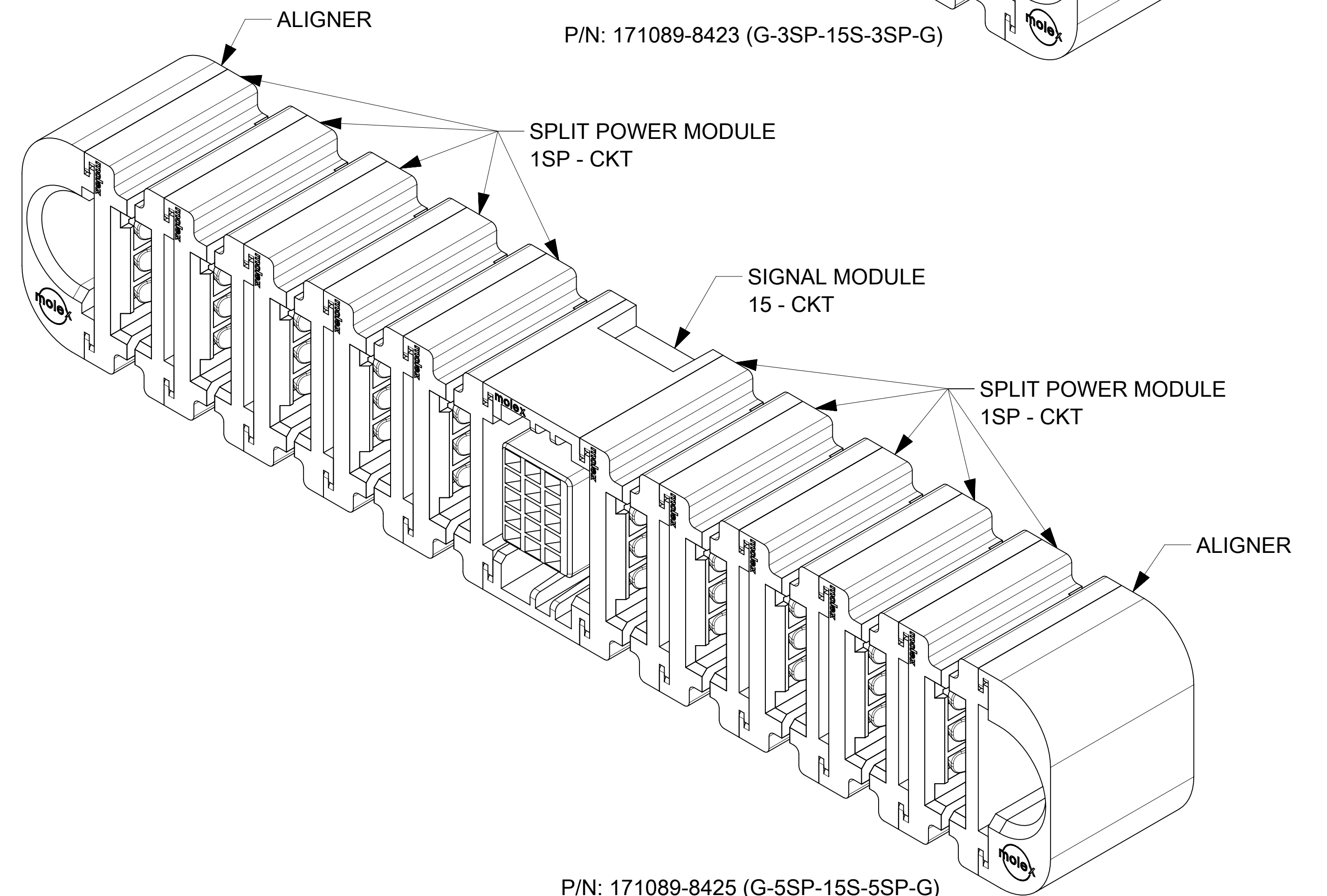

P/N: 171089-8425 (G-5SP-15S-5SP-G)

THIS DRAWING CONTAINS INFORMATION THAT IS PROPRIETARY TO MOLEX ELECTRONIC TECHNOLOGIES, LLC AND SHOULD NOT BE USED WITHOUT WRITTEN PERMISSION											
DIMENSION UNITS		SCALE		CURRENT REV DESC: ADDED ISO VIEWS							
mm		4:1									
GENERAL TOLERANCES (UNLESS SPECIFIED)											
ANGULAR TOL ± 0.5°											
4 PLACES		±		EC NO: 689821							
3 PLACES		±		DRWN: KSUTAR 2021/12/16							
2 PLACES		± 0.13		CHK'D: GJEEVANSURES 2021/12/22							
1 PLACE		± 0.25		APPR: HTHYAGARAJ 2022/02/14							
0 PLACES		±		INITIAL REVISION:							
				DRWN: KSUTAR 2021/09/29							
				APPR: HTHYAGARAJ 2021/11/08							
DRAFT WHERE APPLICABLE MUST REMAIN WITHIN DIMENSIONS				THIRD ANGLE PROJECTION		DRAWING		SERIES		MATERIAL NUMBER	
						D-SIZE		171089		SEE TABLE	
										CUSTOMER	
										GENERAL MARKET	
										SHEET NUMBER	
										3 OF 4	

**molex**

G-\*SP-\*S-\*SP-G  
VERT RECEPTACLE ASSY - TEN60 SPLIT POWER

PRODUCT CUSTOMER DRAWING

DOCUMENT NUMBER DOC TYPE DOC PART REVISION

1710898430 PSD 000 A1

MATERIAL NUMBER CUSTOMER SHEET NUMBER

SEE TABLE GENERAL MARKET 3 OF 4

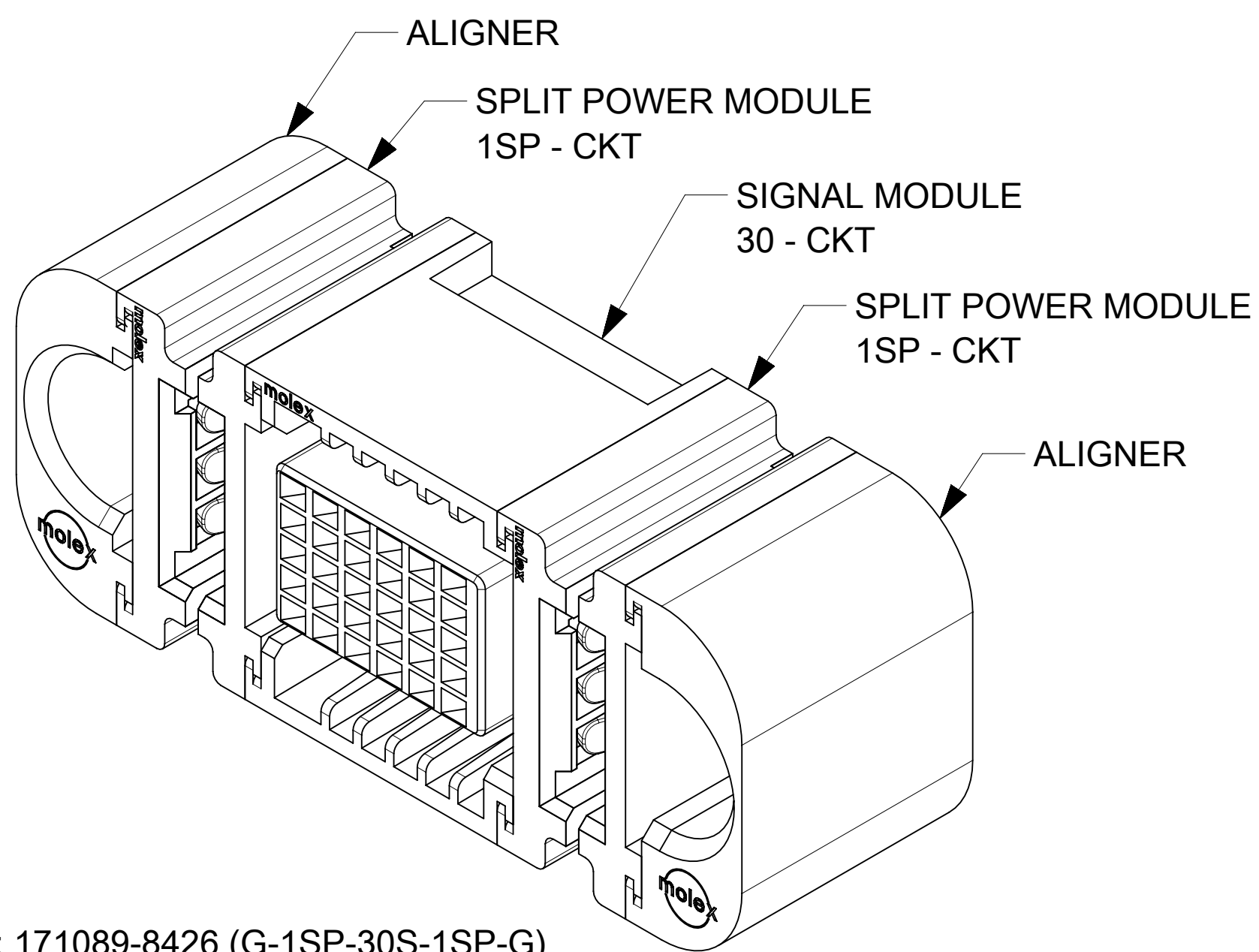

P/N: 171089-8426 (G-1SP-30S-1SP-G)

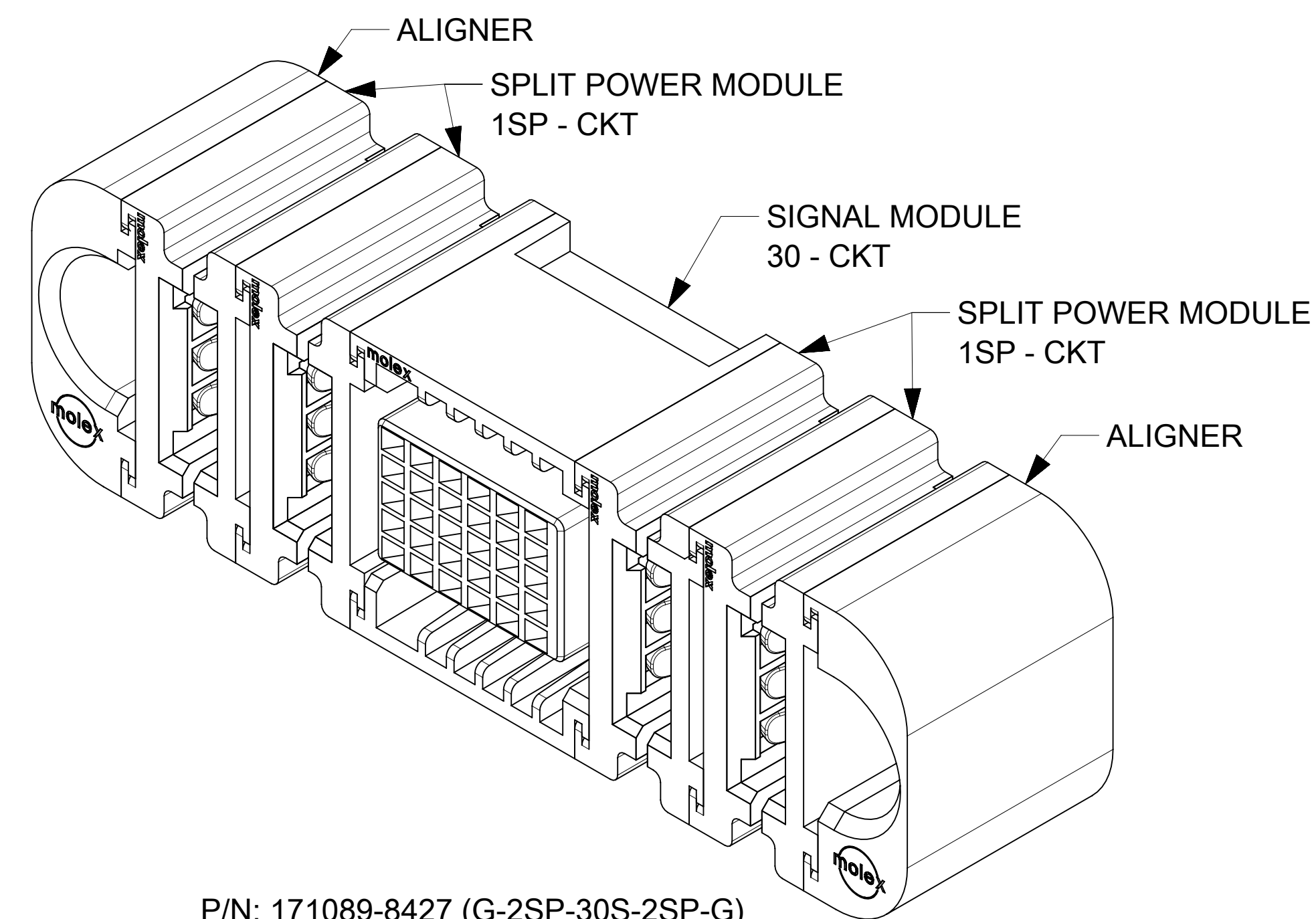

P/N: 171089-8427 (G-2SP-30S-2SP-G)

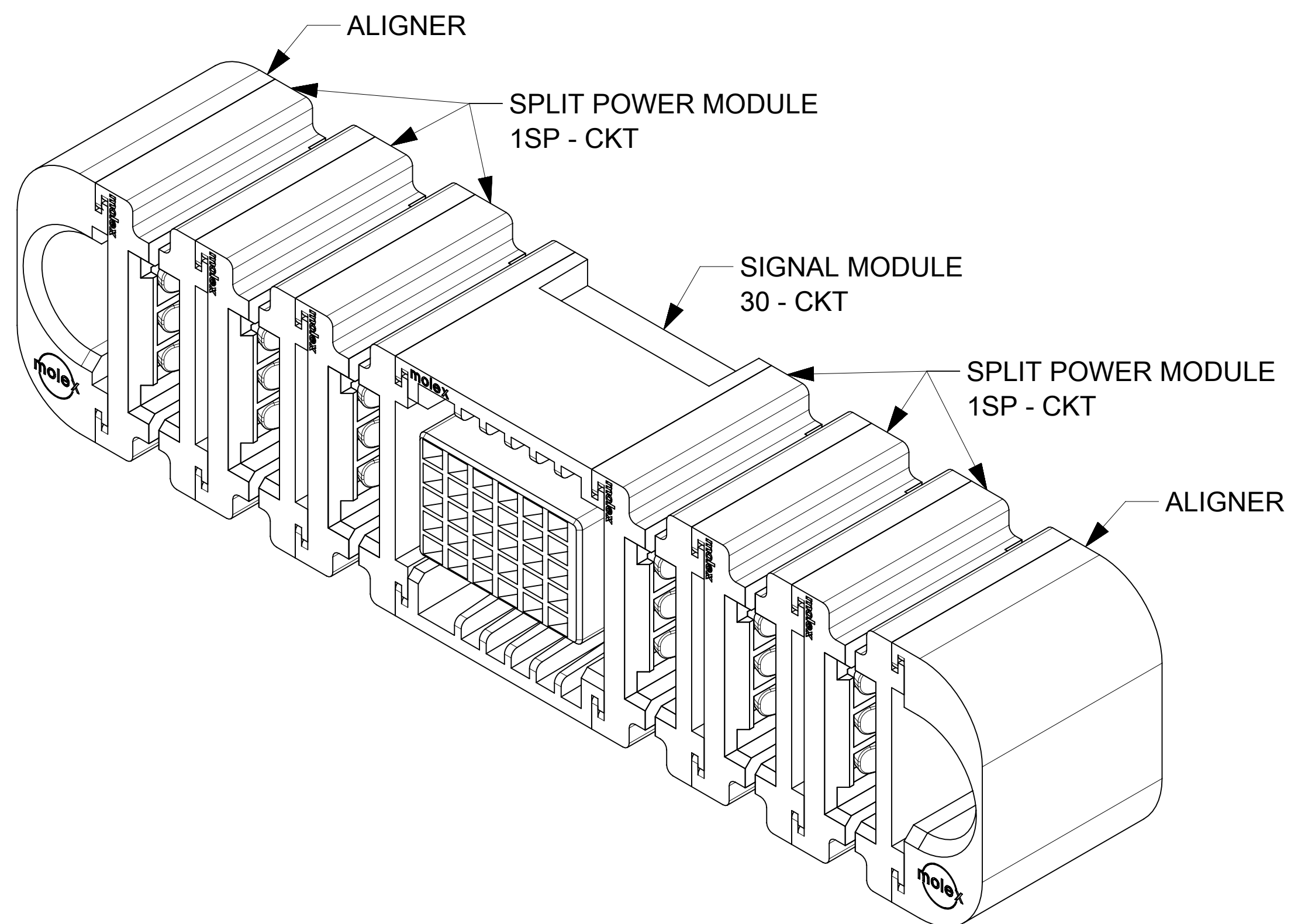

P/N: 171089-8428 (G-3SP-30S-3SP-G)

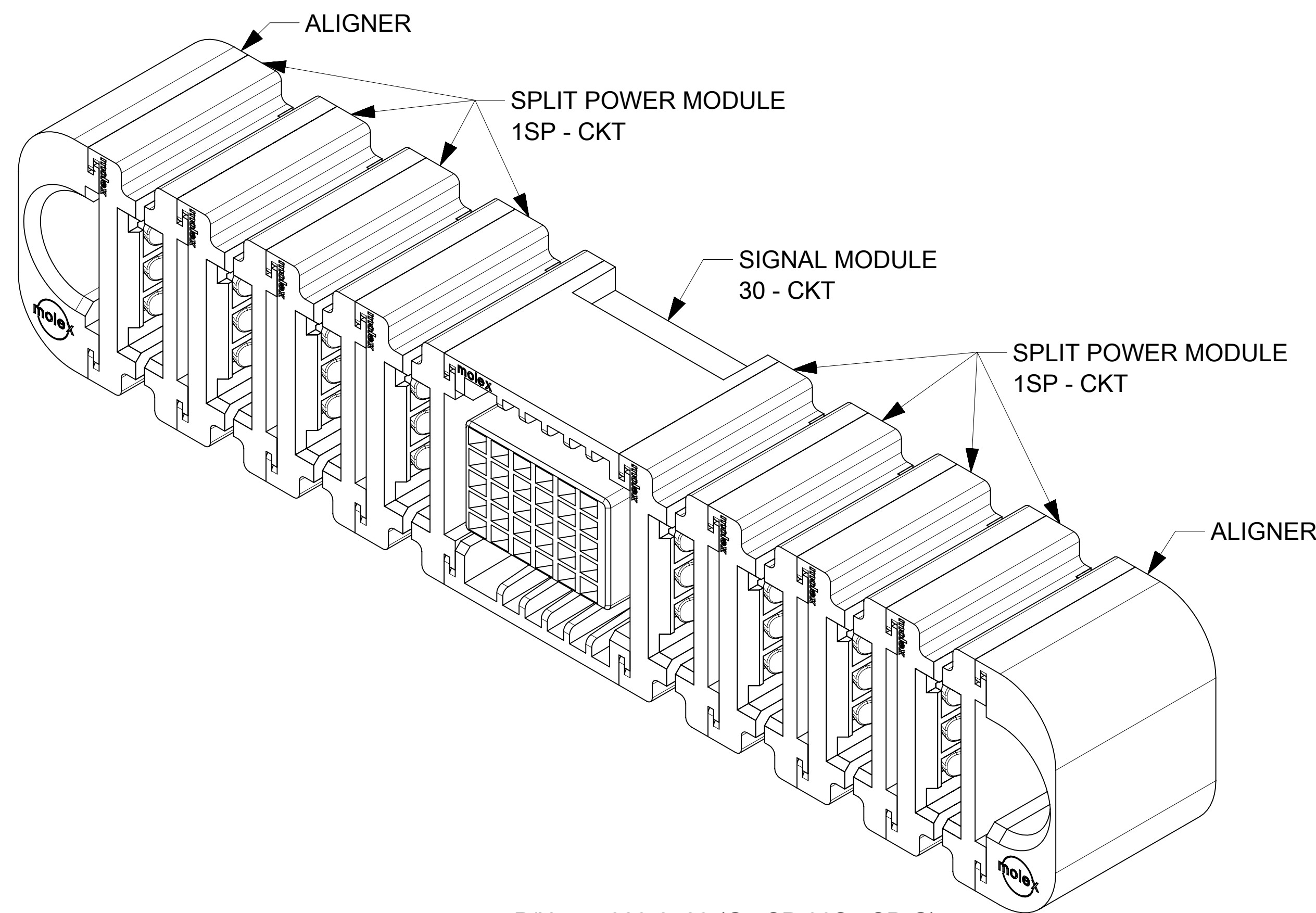

P/N: 171089-8429 (G-4SP-30S-4SP-G)

THIS DRAWING CONTAINS INFORMATION THAT IS PROPRIETARY TO MOLEX ELECTRONIC TECHNOLOGIES, LLC AND SHOULD NOT BE USED WITHOUT WRITTEN PERMISSION											
DIMENSION UNITS		SCALE		CURRENT REV DESC: ADDED ISO VIEWS							
mm		4:1									
GENERAL TOLERANCES (UNLESS SPECIFIED)											
ANGULAR TOL ± 0.5°											
4 PLACES ±				EC NO: 689821							
3 PLACES ±				DRWN: KSUTAR 2021/12/16							
2 PLACES ± 0.13				CHK'D: GJEEVANSURES 2021/12/22							
1 PLACE ± 0.25				APPR: HTHYAGARAJ 2022/02/14							
0 PLACES ±				INITIAL REVISION:							
				DRWN: KSUTAR 2021/09/29							
				APPR: HTHYAGARAJ 2021/11/08							
DRAFT WHERE APPLICABLE MUST REMAIN WITHIN DIMENSIONS				THIRD ANGLE PROJECTION		DRAWING		SERIES		MATERIAL NUMBER	
						D-SIZE		171089		SEE TABLE	
								GENERAL MARKET		SHEET NUMBER	
								GENERAL MARKET		4 OF 4	

**molex**

G-\*SP-\*S-\*SP-G  
VERT RECEPTACLE ASSY - TEN60 SPLIT POWER

PRODUCT CUSTOMER DRAWING

DOCUMENT NUMBER	DOC TYPE	DOC PART	REVISION
1710898430	PSD	000	A1