

SECO-LVDCDC3064-IGBT-G EVB

6-18 Vdc Input Isolated IGBT Gate Driver Supply +15 V / -7.5 V / 7.5 V with Automotive Qualified NCV3064 Controller Evaluation Board User's Manual

Introduction

The SECO-LVDCDC3064-IGBT-GEVB is an isolated supply for IGBT drivers, providing the necessary stable voltage rails $-7.5\text{ V} / 15\text{ V}$ for an efficient switching – as well as an additional 7.5 V rail – over a wide input voltage range (6 Vdc to 18 Vdc). The converter is implemented as a primary side regulated flyback, with the feedback loop signal (1.25 V) realized via an auxiliary winding regulated at 5 V and a voltage divider. The design leverages the several merits of the NCV3064 regulator, enabling a low component count, compact and robust design. Among the features of this converter stand out – e.g. an internal temperature compensated reference, a controlled duty cycle oscillator with an active current limit circuit, driver and high current output switch. The board is realized with Automotive qualified parts and is pin compatible with commercial IGBT DC/DC supplies, provisioning a ready to use plug-in solutions for power applications.

Features

- Core part – NCV3064 (automotive) / NCP3064 (industrial)
- Switching frequency 150 kHz
- Input Voltage 6–18 Vdc
- Output Voltage $-7.5\text{ V} / 7.5\text{ V} / 15\text{ V}$
- Operation mode DCM
- Output Current 50 mA (for each branch)
- Efficiency at full load 67%
- Size 26.24 x 16.38 x 16.06 mm

Transformer Basic Parameters

- Interwinding capacitance 7.8 pF
- Dielectric insulation 4000 Vac
- Inductance 42 μH
- Leakage inductance 390 nH
- Safety standard according to IEC62368-1 / IEC61558-2-16

Applications

- Isolated IGBT driver supply
- Automotive powertrain systems
- Automotive auxiliary power



ON Semiconductor®

www.onsemi.com

EVAL BOARD USER'S MANUAL

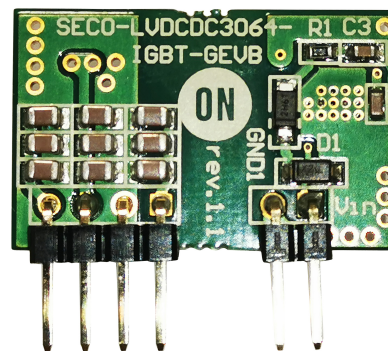
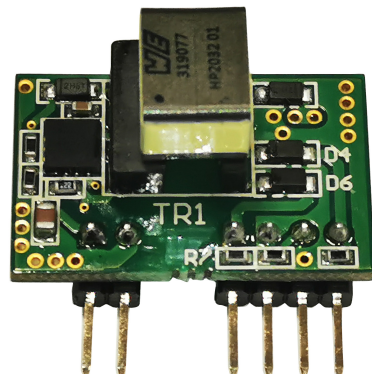

Figure 1. Board Layout

Benefits

- Simple, robust, low component count solution
- Stable performance across wide input voltage range (6 Vdc – 18 Vdc)
- Plug-in header for easy integration to boards
- AEC-Q qualified parts

Collateral

[NCV3064](#)

[SECO-LVDCDC3064-IGBT-GEVB](#) – ORDER THE BOARD

[SECO-GDBB-GEVB](#)

SECO-LVDCDC3064-IGBT-GEVB

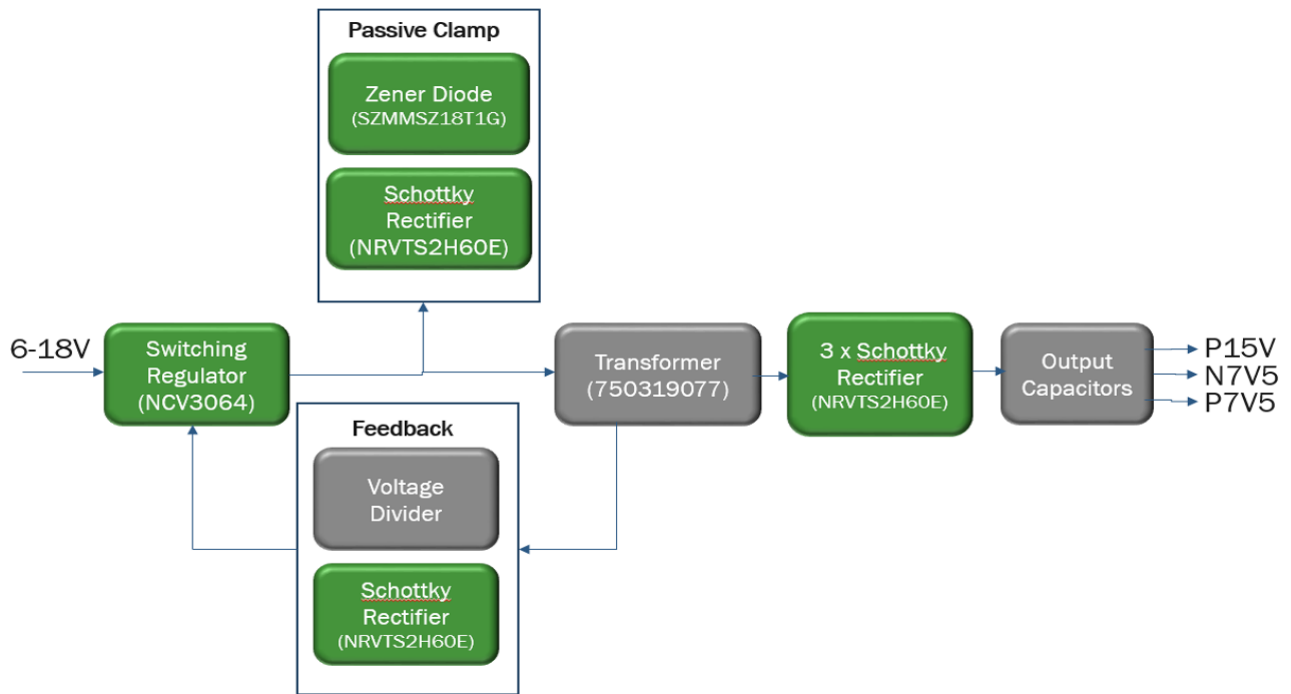

Figure 2. Block Diagram

Scope and Purpose

The purpose of this design note is to present the design of an isolated supply for IGBT drivers with qualified automotive part NCV3064 and transformer. The design was tested as described in this document but not qualified

regarding safety requirements or manufacturing and operation over the whole operating temperature range or lifetime. The hardware is intended for testing under laboratory conditions and by trained specialists only.

DESIGN OVERVIEW

This development is a complete and ready to use IGBT isolated gate driver supply consisting of automotive qualified parts – NCV3064 and transformer. The controller is also available with industrial grade NCP3064. Besides the power rails, the design provides the functional isolation is needed for level shifting when used with high-side gate drivers. Within a power system, the gate driver stage is crucial for an application to deliver the right performance reliably, as an unstable voltage supply to the gate driver will negatively impact the switching efficiency. The system needs to be simple but robust at the same time, in order to provision the required power without increasing the overall design complexity. The benefits of this proposed solution are:

- Simple, robust and low component count solution
- Stable performance across wide input voltage range (6 Vdc – 18 Vdc)
- Plug-in header for easy integration
- AEC-Q qualified parts
- IEC standard transformer

Flyback Topology and Voltage Levels

The flyback topology enables multiple voltage output and isolated power with a simple layout and low components count. This power supply supports an VDC input of 6 V to 18 V and provisions three voltage output rails: +15 V / -7.5 V to be used for the IGBT switching and +7.5 V as an auxiliary power rail. The supply is operated in

Discontinuous Conduction Mode (DCM) regulating the primary auxiliary winding at 5 V. The transformer transmission ration is adjusted to deliver stable voltage output rails at +15 V / -7.5 V and 7.5 V.

NCV3064 (NCP3064)

The NCP3064 Buck Boost Inverting Switching Regulator is a higher frequency upgrade to the popular MC33063A and MC34063A monolithic dc-dc hysteretic converters. This converter embeds multiple relevant features in a small footprint (DFN-8 package), standing out the stable performance over a wide input voltage range. That is a main advantages to consider in this application. Among the features of this converter stand out an internal temperature compensated reference, a controlled duty cycle oscillator with an active current limit circuit, driver and high current output switch. In this design, the ON/OFF pin is externally connected to the input voltage rail. UVLO or OFF control could be implemented with additional logic circuitry, but this functionality is not covered in this design. The NCV3064 is automotive qualified (AEC) and the NCP3064 is available for industrial grade.

Pinout Header (Plug-in)

The pinout header is intended to provide an easy integration interface to development boards or series boards. Pinout is compatible with MORNSUN QA01C with one additional pin P7V5, which can be used as auxiliary power supply. See Layout section for more information.

SECO-LVDCDC3064-IGBT-GEVB

SPECIFICATION

Table 1. SPECIFICATION

Parameters	Values
INPUT	
Voltage	6 – 18 Vdc
Current	400 mA (Vin = 6 V), 125 mA (Vin = 18 V)
OUTPUT	
Power	1.5 W
Voltage	-7.5 / 7.5 / 15 Vdc
Current per branch	50 mA
Total current	150 mA
Efficiency at full load	67% (Vin = 15 V)
Temperature at full load	98°C (Vin = 6 V), 74.5°C (Vin = 15 V), 76°C (Vin = 18 V)
CONTROL	
Core part	NCV3064
Topology	Flyback
Switching frequency	150 kHz
Operation mode	DCM
Primary side peak current	1.1 A
CONSTRUCTION	
Board size	26.24 x 16.38 x 16.06 mm
TRANSFORMER	
Interwinding capacitance	7.8 pF
Dielectric insulation	4000 Vac
Inductance	42 μ H
Leakage inductance	390 nH
Safety standard	IEC62368-1 / IEC61558-2-16
APPLICATION	
Isolated IGBT driver supply, automotive powertrain systems, automotive auxiliary power	

SECO-LVDCDC3064-IGBT-GEVB

SCHEMATIC

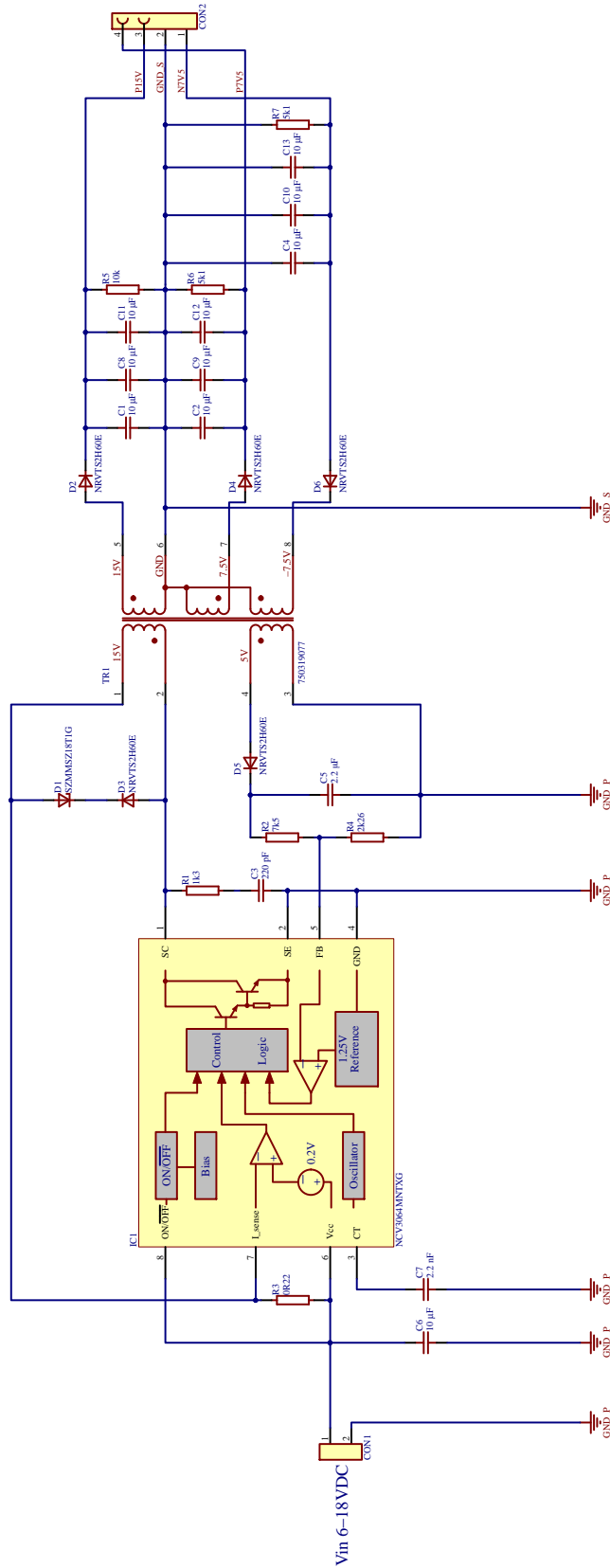

Figure 3. Schematic

TEST REPORT

This section presents the results of the tests conducted on the power supply. The aim of these is to demonstrate The evaluated parameters of the design are:

- Output voltage at different loads and input voltages
- Temperature performance
- Cross regulation measurements
- Output voltage ripple
- Load transients
- Line regulation
- Efficiency

Output Voltages Measurement

In this section output voltages of all branches in relation to load current and different input voltages are showed.

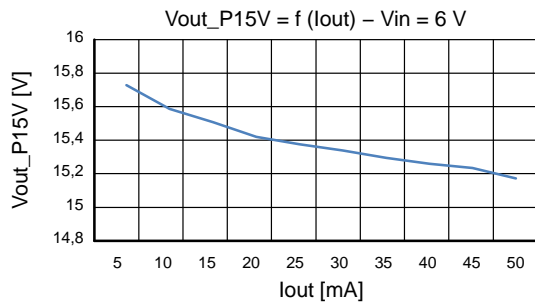

a)

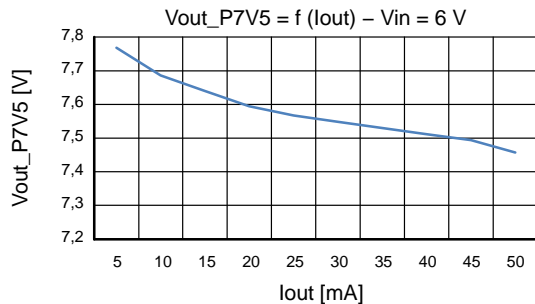

b)

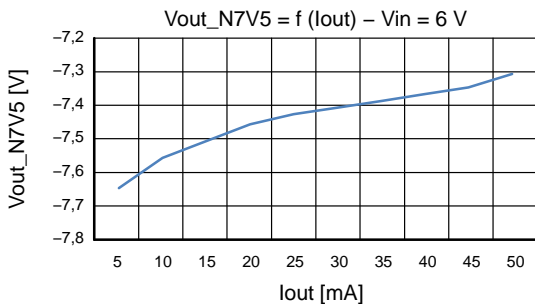

c)

Figure 4. Measurement of Output Voltage for Load Current and 6 V Input Voltage: a) 15 V Branch, b) 7.5 V Branch, c) -7.5 V Branch

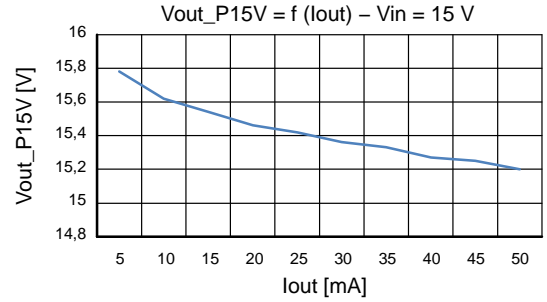

a)

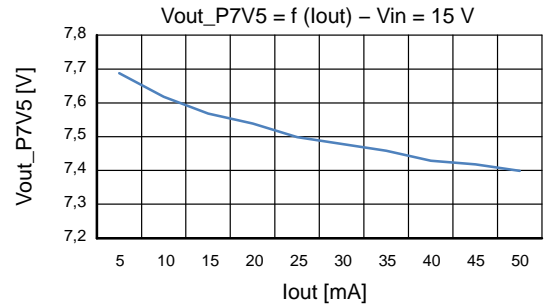

b)

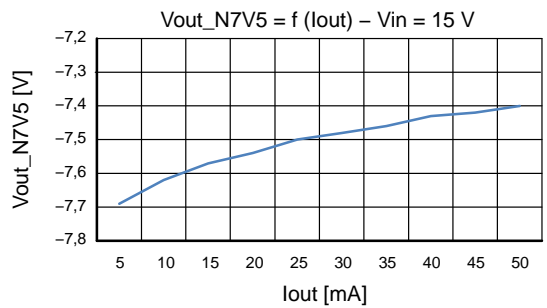

c)

Figure 5. Measurement of Output Voltage for Load Current and 15 V Input Voltage: a) 15 V Branch, b) 7.5 V Branch, c) -7.5 V Branch

SECO-LVDCDC3064-IGBT-GEVB

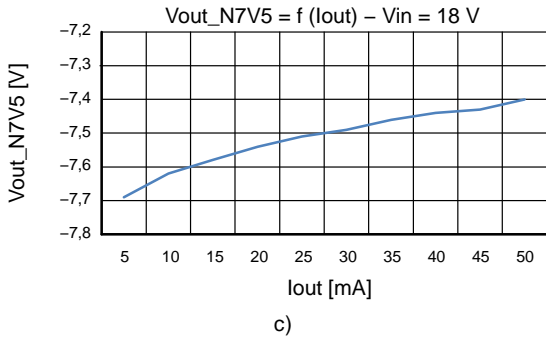
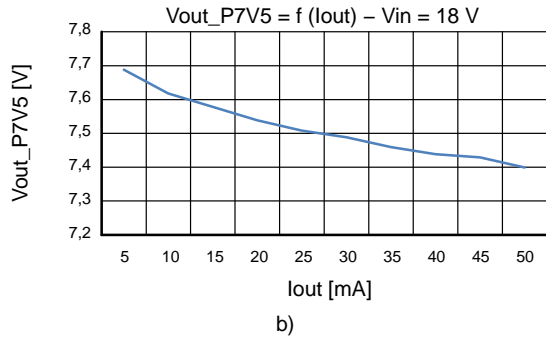
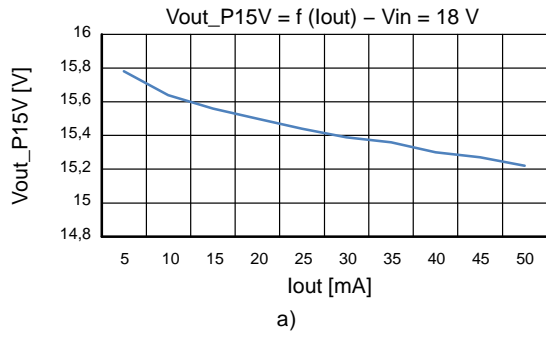

Figure 6. Measurement of Output Voltage for Load Current and 18 V Input Voltage: a) 15 V Branch, b) 7.5 V Branch, c) -7.5 V Branch

Temperature Measurement

Following pictures are showing temperature of converter in full load state (50 mA for each branch) for different input voltages. The working time of device to reach equilibrium state is 20 minutes.

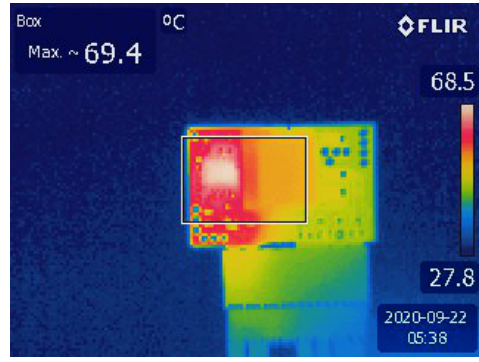
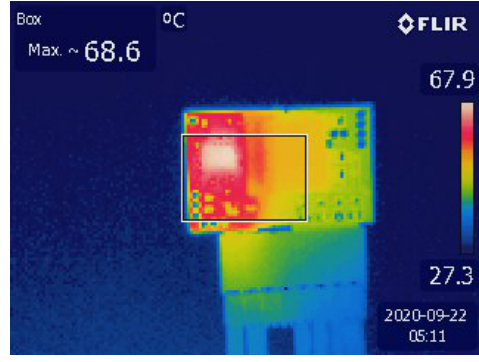
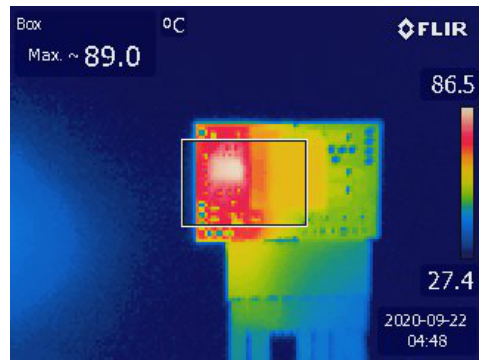

Figure 7. Temperature Measurement During Full Load (50 mA) on Each Branch: a) Input Voltage 6 V, b) Input Voltage 15 V, c) Input Voltage 18 V

SECO-LVDCDC3064-IGBT-GEVB

Cross Regulation Measurement

The flyback is regulated via the primary auxiliary transformer winding at 5 V. Following table is showing

values of output voltages for different output loading. Moreover, the test is performed for values of input voltage 6 V, 15 V, 18 V.

Table 2. VALUES OF OUTPUT VOLTAGES – CROSS REGULATION MEASUREMENT

Vin = 6 V					
P7V5 Full Load (50 mA), N7V5 and P15V No Load		P7V5 No Load, N7V5 and P15V Full Load (50 mA)		P7V5 and N7V5 No Load, P15V Full Load (50 mA)	
Vout_P15V (V)	15.68	15.24		15.01	
Vout_P7V5 (V)	7.00	7.76		7.79	
Vout_N7V5 (V)	-7.64	-7.4		-7.79	
Vin = 15 V					
P7V5 Full Load (50 mA), N7V5 and P15V No Load		P7V5 No Load, N7V5 and P15V Full Load (50 mA)		P7V5 and N7V5 No Load, P15V Full Load (50 mA)	
Vout_P15V (V)	16.02	15.19		14.94	
Vout_P7V5 (V)	6.78	7.79		7.82	
Vout_N7V5 (V)	-7.72	-7.38		-7.82	
Vin = 18 V					
P7V5 Full Load (50 mA), N7V5 and P15V No Load		P7V5 No Load, N7V5 and P15V Full Load (50 mA)		P7V5 and N7V5 No Load, P15V Full Load (50 mA)	
Vout_P15V (V)	16.04	15.22		14.94	
Vout_P7V5 (V)	6.76	7.8		7.82	
Vout_N7V5 (V)	-7.73	-7.39		-7.82	

Measurement of Output Voltage Ripple

The output voltage ripple measurement is done on P15V and N7V5 branch. Results for P7V5 branch are considered to be the same as for the N7V5 ones. Used conditions are: no load, half load and full load on all of the three branches and additional condition where just measured branch is fully loaded and the other two have no load. The last one condition is the worst case regarding the voltage ripple. All of these measurements are done for input voltage value 6 V, 15 V, 18 V. Results can be seen in the table 3. Ripple is calculated as $(V_{max} - V_{min}) / V_{DC} \times 100$, where V_{max} is the maximal value of voltage on given output and V_{min} is the minimal value. The worst case of voltage ripple can also be seen in the figure 7.

Table 3. OUTPUT VOLTAGE RIPPLE FOR DIFFERENT CONDITIONS

	No Load	50% Load	100% Load	100% Load just on P15V Branch
P15V BRANCH				
Vin = 6 V				
Vripple [%]	0.4	1	1.46	2.21
Vin = 15 V				
Vripple [%]	1.31	1.29	1.82	2.67
Vin = 18 V				
Vripple [%]	1.58	1.4	1.9	2.95
N7V5 BRANCH				
Vin = 6 V				
Vripple [%]	0.38	2.28	2.69	4.55
Vin = 15 V				
Vripple [%]	1.43	2.41	3.24	4.77
Vin = 18 V				
Vripple [%]	1.53	2.54	4.05	4.95

SECO-LVDCDC3064-IGBT-GEVB

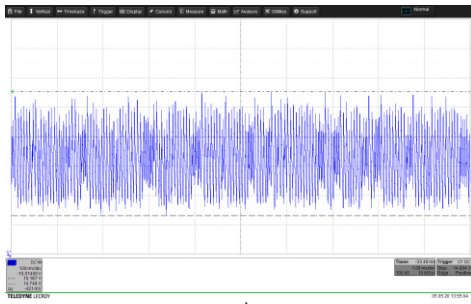

a)

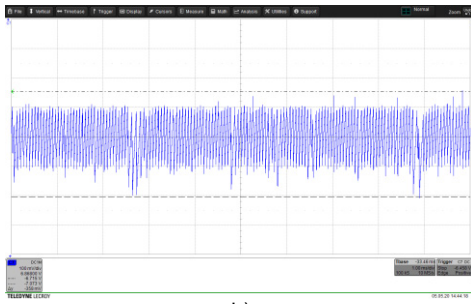

b)

Figure 8. Output Voltage Ripple for the Worst Cases:
a) P15V Branch – $V_{in} = 18\text{ V}$, just P15V is Fully Loaded,
b) N7V5 Branch – $V_{in} = 18\text{ V}$ just N7V5 is Fully Loaded

Short Circuit Measurement

The short circuit test is done during no load condition where always just one branch is short circuited. The waveforms of output voltages during the test are in the figure 9.

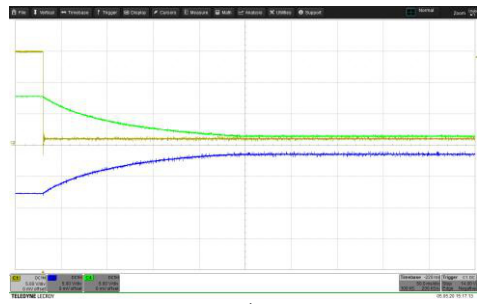

a)

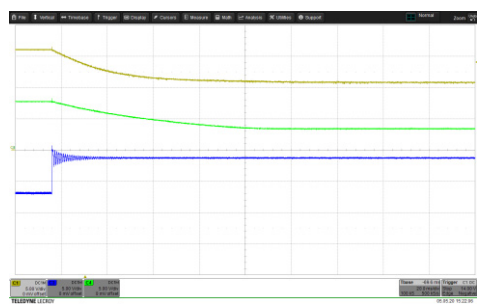

b)

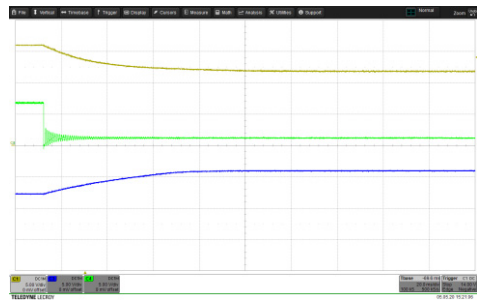

c)

Figure 9. Short Circuit Tests (Yellow – P15V, Green – P7V5, Blue – N7V5): a) Short Circuit on P15V, b) Short Circuit on N7V5, c) Short Circuit on P7V5

Load Transients Measurement

The load transient measurements are done for P15V and N7V5 branch. During the test just measured branch is loaded alternately with full load (50 mA) for 1.5 ms and no load for 1.5 ms, the other two have no load. Results are in the figure 10.

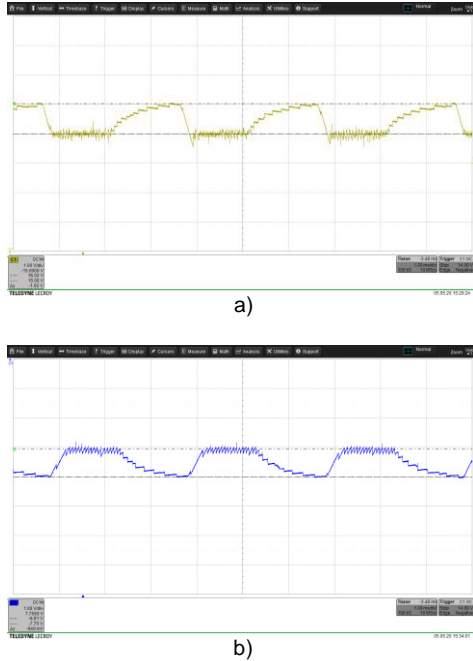
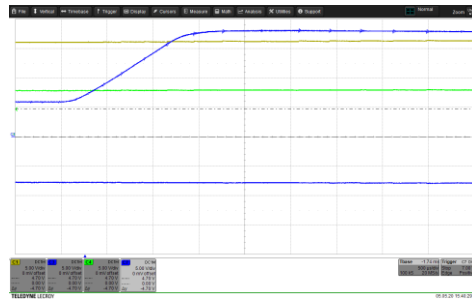

Figure 10. Load Transients Measurement:
a) P15V Branch, b) N7V5 Branch

Line Regulation Measurement

In this test the reaction of the output voltages on the input voltage change from 6 V to 18 V for 1ms is measured. The test is performed for no load and full load condition on all of the branches. Results can be seen in the figure 11.



a)

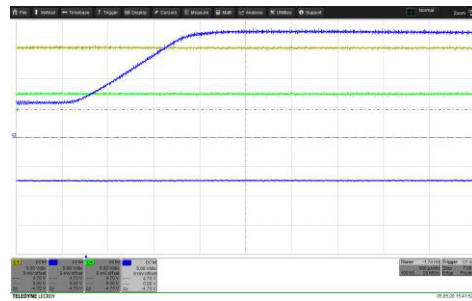

b)

Figure 11. Line Regulation Measurement (Blue – Vin, N7V5, Green – P7V5, Yellow – P15V): a) No Load Condition, b) Full Load Condition

Efficiency Measurement

Efficiency is measured for different load condition from 5 mA to 50 mA (full load for one branch) with step 5 mA. The branches are loaded simultaneously. It means that the resulting load is from 15 mA to 150 mA. Results can be seen in the figure 12.

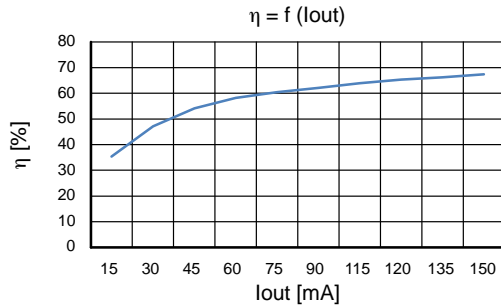

Figure 12. Efficiency for Different Output Load

SECO-LVDCDC3064-IGBT-GEVB

TRANSFORMER DESIGN

The transformer is developed according to IEC62368-1 / IEC61558-2-16 safety standards and working in Discontinuous Current Mode (DCM). The used flyback transformer is an off-the-shelf part from Würth Elektronik,

which ensures the needed voltages, isolation according to the aforementioned standards and low interwinding capacitance.

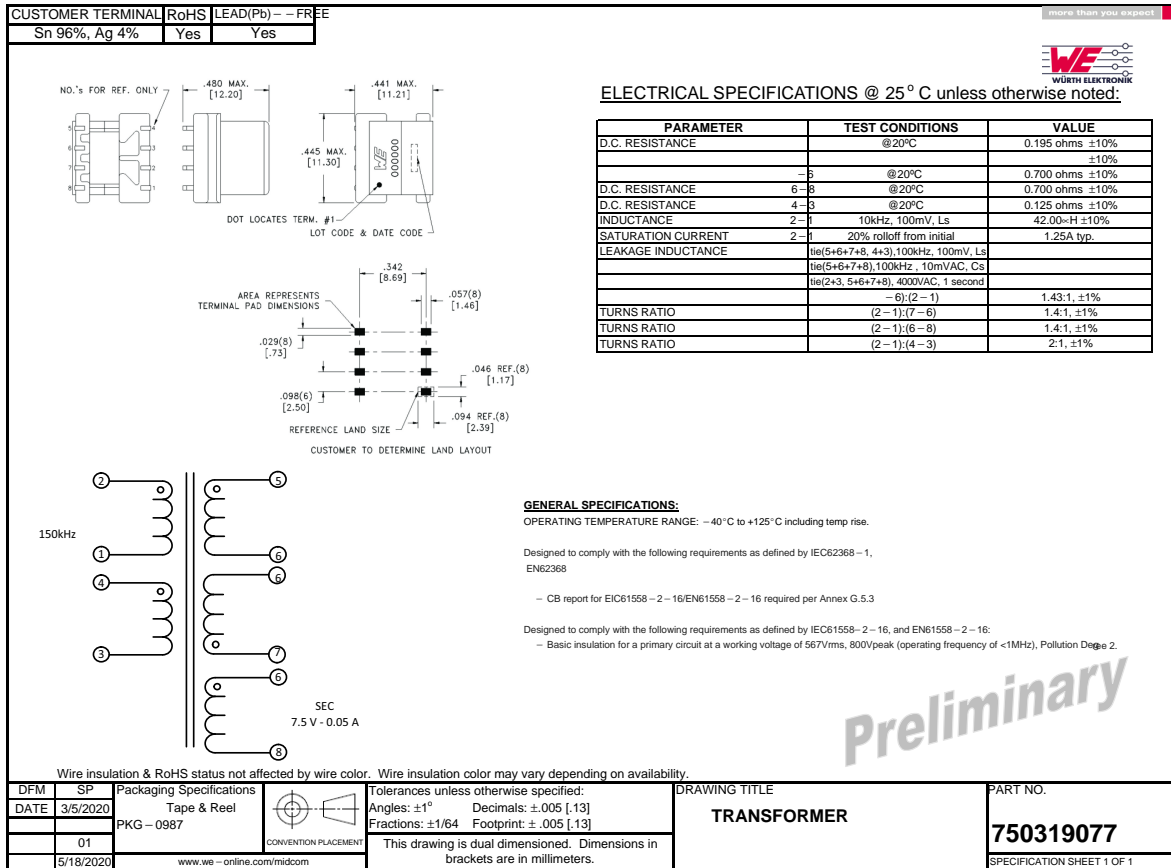

Figure 13. Drawing and Parameters of Used Transformer

SECO-LVDCDC3064-IGBT-GEVB

DEVELOPMENT RESOURCES AND TOOLS

Collateral, development files and other development resources listed below are available at SECO-LVDCDC3064-IGBT-GEVB

- Schematics
- BOM (below as well)

- Manufacturing files
- PCB layout (below as well)
- Altium files
- Simulation model (below as well)

Table 4. BILL OF MATERIALS

#	Designator	Comment	Description	Manufacturer	Manufacturer Part Number
1.	C1, C2, C4, C6, C8, C9, C10, C11, C12, C13	10 μ F	SMD Multilayer Ceramic Capacitor, 10 μ F, 25 V, 0805 [2012 Metric], \pm 10%, X7S, CGA Series	TDK	CGA4J1X7S1E106K125AE
.	C3	220 pF	Multilayer Ceramic Capacitors MLCC – SMD/SMT 50 V 220 pF 0603 X7R 10% AEC-Q200	KEMET	C0603C221K5RACAUTO
3.	C5	2.2 μ F	GRT188C81E225KE13D – SMD Multilayer Ceramic Capacitor, 2.2 μ F, 25 V, 0603 [1608 Metric], \pm 10%, X6S, GRT Series, Murata	Murata	GRT188C81E225KE13D
4.	C7	2.2 nF	Multilayer Ceramic Capacitors MLCC – SMD/SMT CGA 0603 50 V 2200 pF X7R 10% AEC-Q200	TDK	CGA3E2X7R1H222K080AA
5.	CON1	613 002 110 21	PTH right angle male header 2 pins 2.54 mm pitch Würth Elektronik	Würth Elektronik	61300211021
6.	CON2	61300411021	WR-PHD 2.54 mm THT Angled Pin Header 1x4	Würth Elektronik	61300411021
7.	D1	SZMMSZ18T1G	Zener Single Diode, 18 V, 500 mW, SOD-123, 5 %, 2 Pins, 150°C	ON Semiconductor	SZMMSZ18T1G
8.	D2, D3, D4, D5, D6	NRVTS2H60E	Trench Schottky Rectifier, Very Low Leakage 2 A, 60 V ON Semiconductor	ON Semiconductor	NRVTS2H60ESFT1G
9.	IC1	NCV3064MNTXG	Buck / Boost / Inverting Converter, Switching Regulator, 1.5 A, with On/Off Function	ON Semiconductor	NCV3064MNTXG
10.	R1	1.3 k Ω	SMD thick film resistor 1.3 k Ω 0603 1% 100 mW Panasonic	Panasonic	ERJ3EKF1301V
11.	R2	0.22 Ω	SMD thick film resistor 0.22 Ω 0603 1% 100 mW Panasonic	Panasonic	ERJ3EKF7501V
12.	R3	0.22 Ω	SMD Current Sense Resistor, 0.22 Ω , ERJ3R Series, 0603 [1608 Metric], 100 mW, \pm 1%, Thick Film, Panasonic	Panasonic	ERJ3RQFR22V
13.	R4	2.26 k Ω	SMD thick film resistor 2.26 k Ω 0603 1% 100 mW Panasonic	Panasonic	ERJ3EKF2261V
14.	R5	10 k Ω	SMD thick film resistor 10 k Ω 0603 1% 100 mW Panasonic	Panasonic	ERJ3EKF1002V
15.	R6, R7	5.1 k Ω	SMD thick film resistor 5.1 k Ω 0603 1% 100 mW Panasonic	Panasonic	ERJ3EKF5101V
16.	TR1	750319077	Custom transformer Flyback converter Uin = 15 V Uout1 = 15 V Uout2 = -7.5 V Uout3 = 7.5 V Uout4_aux = 5 V	Würth Elektronik	750319077

SECO-LVDCDC3064-IGBT-GEVB

Layout

The board is designed in two layers with size of 26.24 x 16.38 x 16.06 mm. The pinout is compatible with commercial DC/DC block converters for gate drivers

supply, and includes one additional pin P7V5, which can be used as auxiliary power supply. Figure of top, bottom layer and front view can be seen in the Figure 14.

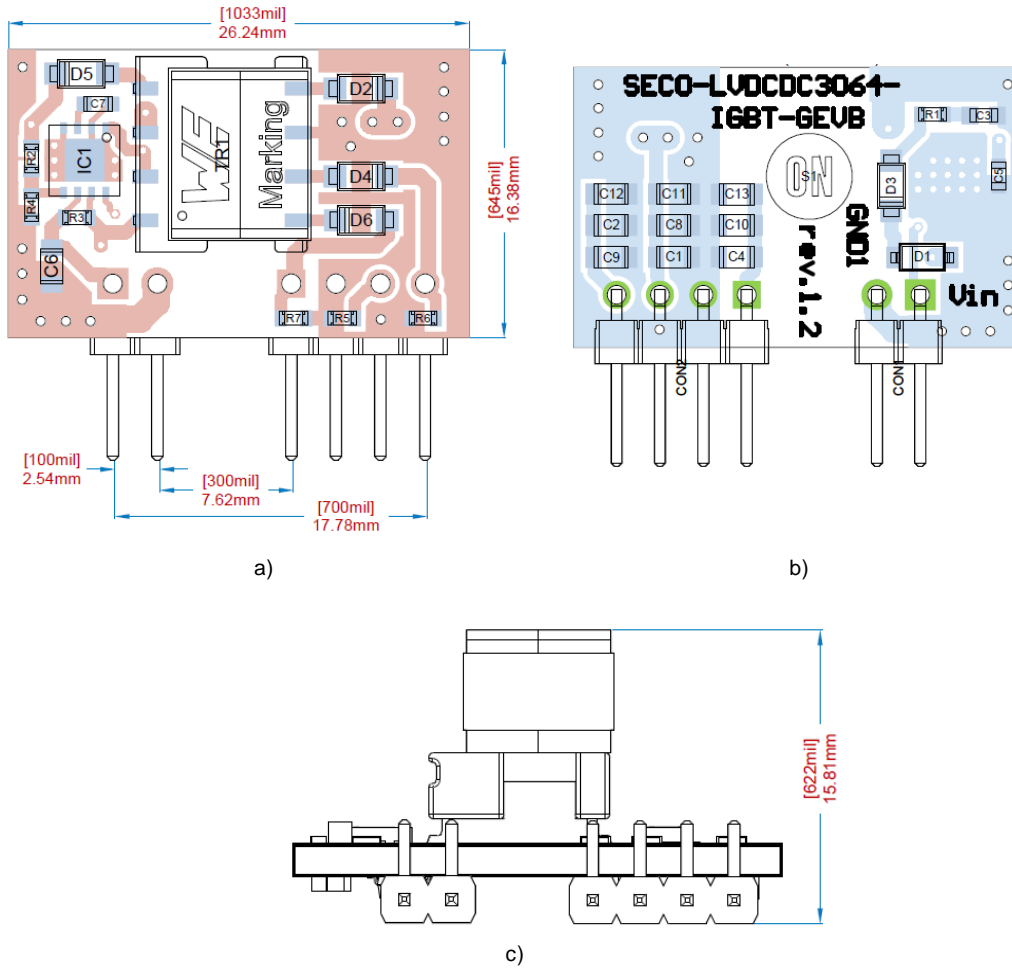

Figure 14. Board Layout: a) Top Side with Dimensions b) Bottom Side c) Front Side. Header is Pin Compatible with Standard DC/DC Isolated Supply Bricks.

Simulation Model

This model is created and used as a behavioral one to get the first iteration of design. Schematic from SIMetrix can be

seen in the figure 15. Figure 16 and 17 is showing output voltages during full load state for input voltage 6 and 15 V.

SECO-LVDCDC3064-IGBT-GEVB

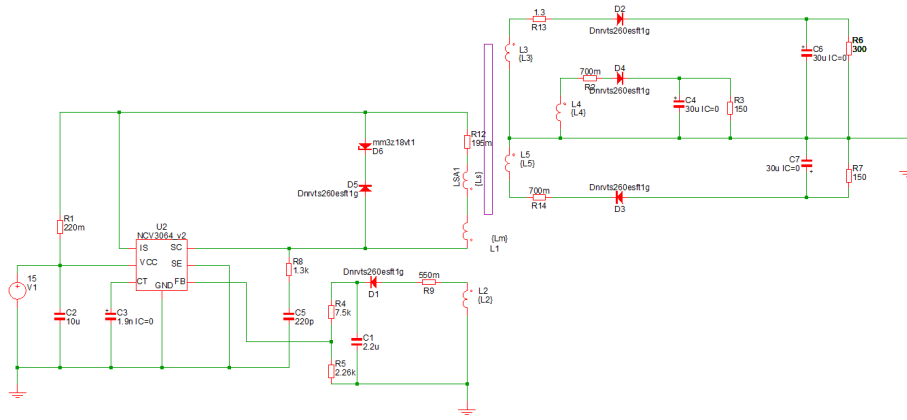

Figure 15. Simulation Model

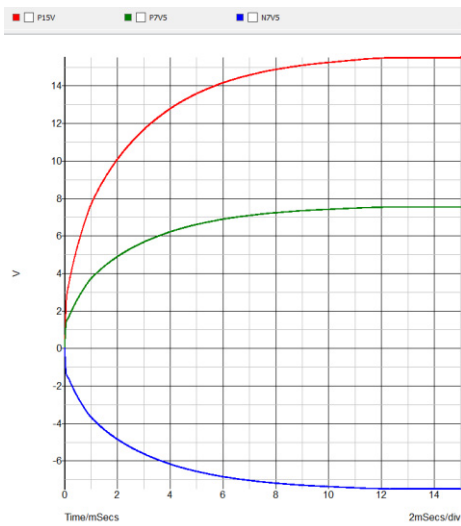

Figure 16. Output Voltages for $V_{in} = 6\text{ V}$

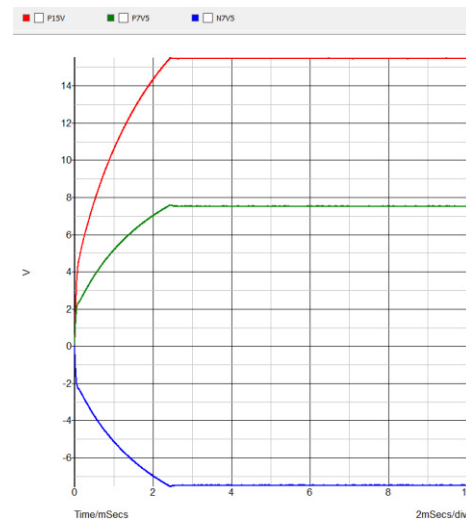

Figure 17. Output Voltages for $V_{in} = 15\text{ V}$

REFERENCES

1. [NCP3064/D](#) – Buck / Boost / Inverting Converter, Switching Regulator, 1.5 A, with On/Off Function.

onsemi, **Onsemi**, and other names, marks, and brands are registered and/or common law trademarks of Semiconductor Components Industries, LLC dba "**onsemi**" or its affiliates and/or subsidiaries in the United States and/or other countries. **onsemi** owns the rights to a number of patents, trademarks, copyrights, trade secrets, and other intellectual property. A listing of **onsemi**'s product/patent coverage may be accessed at www.onsemi.com/site/pdf/Patent-Marking.pdf. **onsemi** is an Equal Opportunity/Affirmative Action Employer. This literature is subject to all applicable copyright laws and is not for resale in any manner.

The evaluation board/kit (research and development board/kit) (hereinafter the "board") is not a finished product and is not available for sale to consumers. The board is only intended for research, development, demonstration and evaluation purposes and will only be used in laboratory/development areas by persons with an engineering/technical training and familiar with the risks associated with handling electrical/mechanical components, systems and subsystems. This person assumes full responsibility/liability for proper and safe handling. Any other use, resale or redistribution for any other purpose is strictly prohibited.

THE BOARD IS PROVIDED BY ONSEMI TO YOU "AS IS" AND WITHOUT ANY REPRESENTATIONS OR WARRANTIES WHATSOEVER. WITHOUT LIMITING THE FOREGOING, ONSEMI (AND ITS LICENSORS/SUPPLIERS) HEREBY DISCLAIMS ANY AND ALL REPRESENTATIONS AND WARRANTIES IN RELATION TO THE BOARD, ANY MODIFICATIONS, OR THIS AGREEMENT, WHETHER EXPRESS, IMPLIED, STATUTORY OR OTHERWISE, INCLUDING WITHOUT LIMITATION ANY AND ALL REPRESENTATIONS AND WARRANTIES OF MERCHANTABILITY, FITNESS FOR A PARTICULAR PURPOSE, TITLE, NON-INFRINGEMENT, AND THOSE ARISING FROM A COURSE OF DEALING, TRADE USAGE, TRADE CUSTOM OR TRADE PRACTICE.

onsemi reserves the right to make changes without further notice to any board.

You are responsible for determining whether the board will be suitable for your intended use or application or will achieve your intended results. Prior to using or distributing any systems that have been evaluated, designed or tested using the board, you agree to test and validate your design to confirm the functionality for your application. Any technical, applications or design information or advice, quality characterization, reliability data or other services provided by **onsemi** shall not constitute any representation or warranty by **onsemi**, and no additional obligations or liabilities shall arise from **onsemi** having provided such information or services.

onsemi products including the boards are not designed, intended, or authorized for use in life support systems, or any FDA Class 3 medical devices or medical devices with a similar or equivalent classification in a foreign jurisdiction, or any devices intended for implantation in the human body. You agree to indemnify, defend and hold harmless **onsemi**, its directors, officers, employees, representatives, agents, subsidiaries, affiliates, distributors, and assigns, against any and all liabilities, losses, costs, damages, judgments, and expenses, arising out of any claim, demand, investigation, lawsuit, regulatory action or cause of action arising out of or associated with any unauthorized use, even if such claim alleges that **onsemi** was negligent regarding the design or manufacture of any products and/or the board.

This evaluation board/kit does not fall within the scope of the European Union directives regarding electromagnetic compatibility, restricted substances (RoHS), recycling (WEEE), FCC, CE or UL, and may not meet the technical requirements of these or other related directives.

FCC WARNING – This evaluation board/kit is intended for use for engineering development, demonstration, or evaluation purposes only and is not considered by **onsemi** to be a finished end product fit for general consumer use. It may generate, use, or radiate radio frequency energy and has not been tested for compliance with the limits of computing devices pursuant to part 15 of FCC rules, which are designed to provide reasonable protection against radio frequency interference. Operation of this equipment may cause interference with radio communications, in which case the user shall be responsible, at its expense, to take whatever measures may be required to correct this interference.

onsemi does not convey any license under its patent rights nor the rights of others.

LIMITATIONS OF LIABILITY: **onsemi** shall not be liable for any special, consequential, incidental, indirect or punitive damages, including, but not limited to the costs of requalification, delay, loss of profits or goodwill, arising out of or in connection with the board, even if **onsemi** is advised of the possibility of such damages. In no event shall **onsemi**'s aggregate liability from any obligation arising out of or in connection with the board, under any theory of liability, exceed the purchase price paid for the board, if any.

The board is provided to you subject to the license and other terms per **onsemi**'s standard terms and conditions of sale. For more information and documentation, please visit www.onsemi.com.

PUBLICATION ORDERING INFORMATION

LITERATURE FULFILLMENT:

Email Requests to: orderlit@onsemi.com

onsemi Website: www.onsemi.com

TECHNICAL SUPPORT

North American Technical Support:

Voice Mail: 1 800-282-9855 Toll Free USA/Canada

Phone: 011 421 33 790 2910

Europe, Middle East and Africa Technical Support:

Phone: 00421 33 790 2910

For additional information, please contact your local Sales Representative