

# 7mm Spot Diameter LED

OP207CL



## Features:

- SMD Configuration
- Emission Spot Size is 7 mm diameter
- High Power Output with Parallel Rays
- Uniform Distribution
- Emitter Source for Encoder Applications

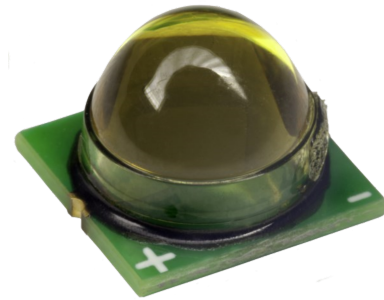

## Description:

The **OP207CL** is a high power IR LED designed for encoder applications. The LED features a small foot print, low profile for a 7 mm beam diameter. Radiance is a collimated, narrow beam emission pattern provides on-axis intensity for excellent coupling efficiency for encoder applications.

## Applications:

- Linear & Rotary Encoder
- Optical Sensors Switches
- Long Range Light Barriers
- Optical Scanning and Edge Sensing

## Package Dimensions

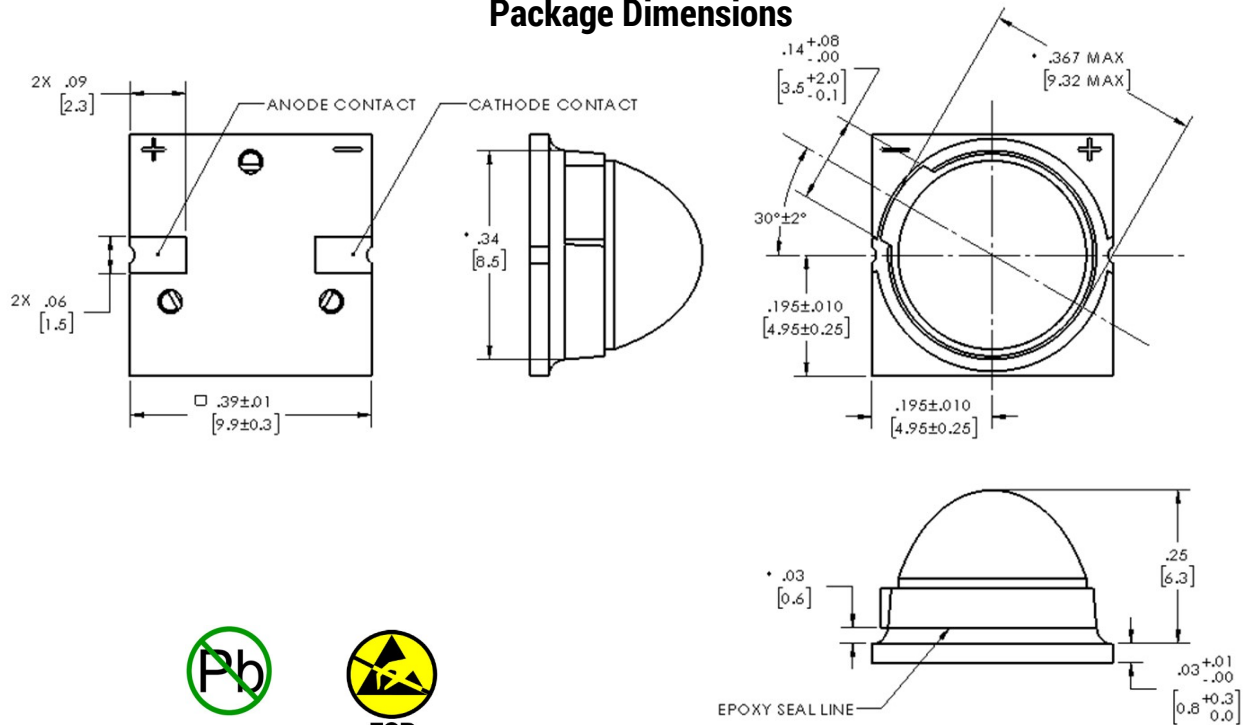

RoHS



ESD  
(Human Body Model)

\* MEASUREMENTS MADE AT EPOXY SEAL LINE

DIMENSIONS IN INCHES [MM]  
TOL  $\pm 0.01$  [0.25] UNLESS OTHERWISE STATED

## General Note

TT Electronics reserves the right to make changes in product specification without notice or liability. All information is subject to TT Electronics' own data and is considered accurate at time of going to print.

TT Electronics | OPTEK Technology  
2900 E. Plano Pkwy, Plano, TX 75074 | Ph: +1 972 323 2200  
www.ttelectronics.com | sensors@ttelectronics.com

### Electrical Specification

Absolute Maximum Ratings ( $T_A = 25^\circ\text{C}$ unless otherwise noted)	
Storage Temperature Range	$-40^\circ\text{C}$ to $+105^\circ\text{C}$
Operating Temperature Range	$-40^\circ\text{C}$ to $+105^\circ\text{C}$
Reverse Voltage	10 V
Continuous Forward Current	100 mA
Power Dissipation <sup>(1)</sup>	190 mW
Peak Package Body Temperature ( $T_p$ ) <sup>(2)</sup>	$200^\circ\text{C}$

Electrical Characteristics ( $T_A = 25^\circ\text{C}$ unless otherwise noted)						
SYMBOL	PARAMETER	MIN	TYP	MAX	UNITS	TEST CONDITIONS
$P_O$	Total Output Radiant Power	10.0	-		mW	$I_F = 50\text{ mA}$
Sd	Spot Light Diameter		7.0		mm	$I_F = 50\text{ mA}$ , measured at 1.5mm from lens tip
$\frac{1}{2} \theta_{HP}$	Half Intensity Beam Angle		2.25		Degree	$I_F = 50\text{ mA}$
$\lambda_P$	Wavelength at Peak Emission	840	855	870	nm	$I_F = 100\text{ mA}$
$V_F$	Forward Voltage		1.5	1.9	V	$I_F = 50\text{ mA}$
$I_R$	Reverse Leakage Current		-	10	$\mu\text{A}$	$V_R = 5.0\text{V}$
$t_r, t_f$	Rise Time, Fall Time		22		ns	$I_{F(PK)} = 50\text{mA}$ , $PW = 10\mu\text{s}$ , 10% D.C.

- Notes:
- Derate linearly at 3.42 mW/ $^\circ\text{C}$  above  $60^\circ\text{C}$ .
  - For hand soldering use SAC solder. No clean flux recommended.

### Recommended Land Pattern

Tolerance  $\pm .005$  inches

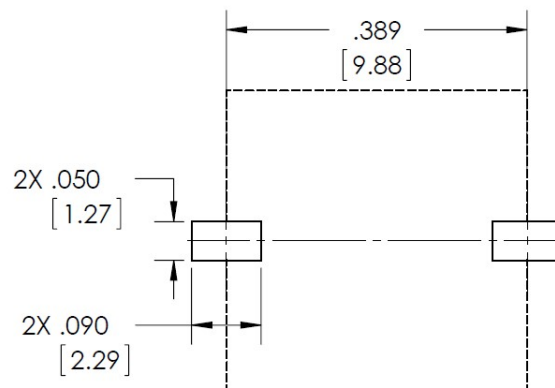

#### General Note

TT Electronics reserves the right to make changes in product specification without notice or liability. All information is subject to TT Electronics' own data and is considered accurate at time of going to print.

TT Electronics | OPTEK Technology  
 2900 E. Plano Pkwy, Plano, TX 75074 | Ph: +1 972 323 2200  
[www.ttelectronics.com](http://www.ttelectronics.com) | [sensors@ttelectronics.com](mailto:sensors@ttelectronics.com)

# 7mm Spot Diameter LED

OP207CL



## Characteristic Curves (typical)

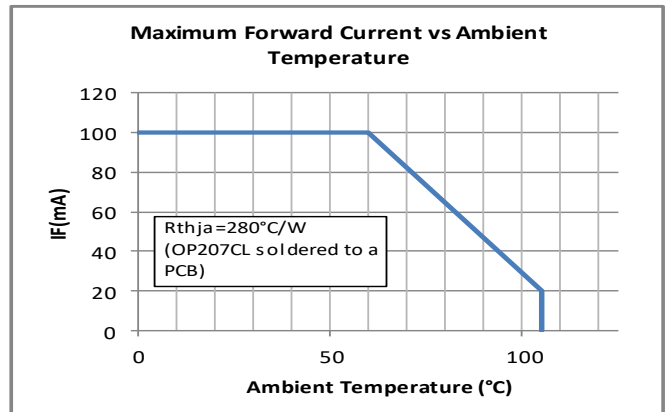
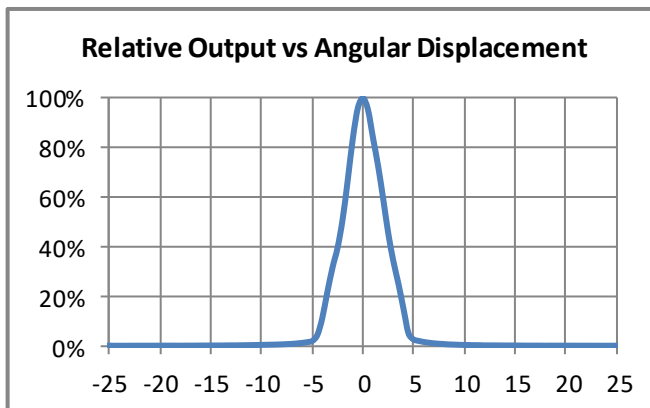
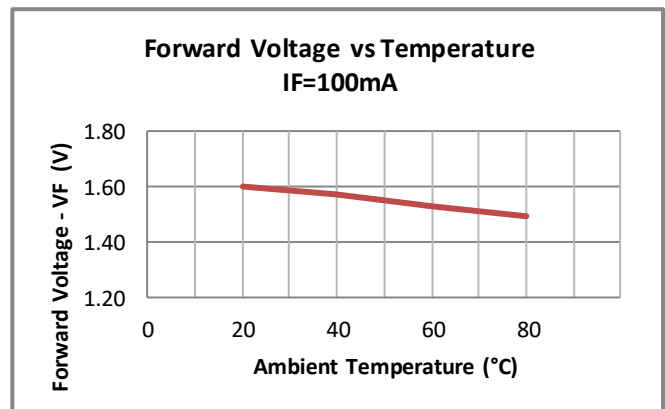
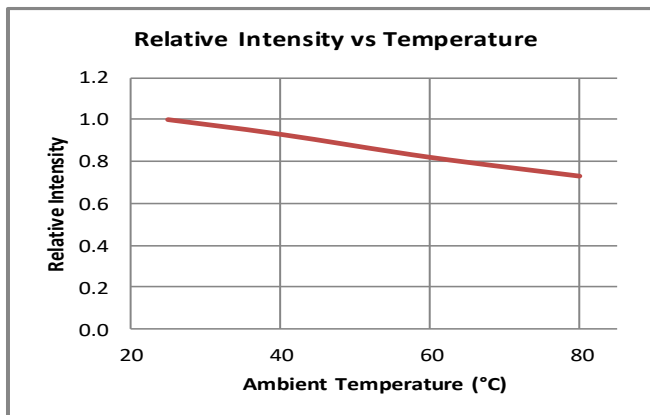
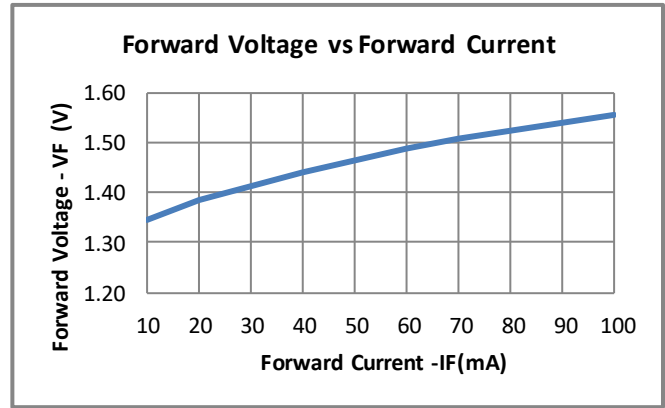
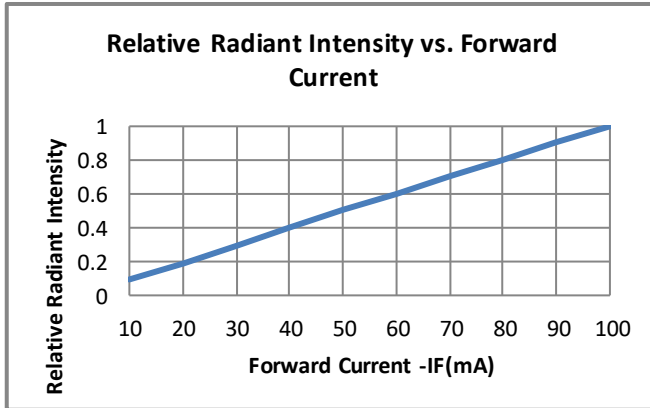

General Note  
 TT Electronics reserves the right to make changes in product specification without notice or liability. All information is subject to TT Electronics' own data and is considered accurate at time of going to print.

TT Electronics | OPTEK Technology  
 2900 E. Plano Pkwy, Plano, TX 75074 | Ph: +1 972 323 2200  
[www.ttelectronics.com](http://www.ttelectronics.com) | [sensors@ttelectronics.com](mailto:sensors@ttelectronics.com)

# 7mm Spot Diameter LED

OP207CL



## Characteristic Curves (typical)

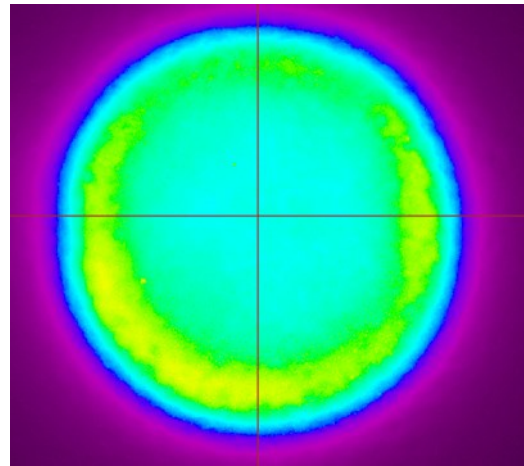
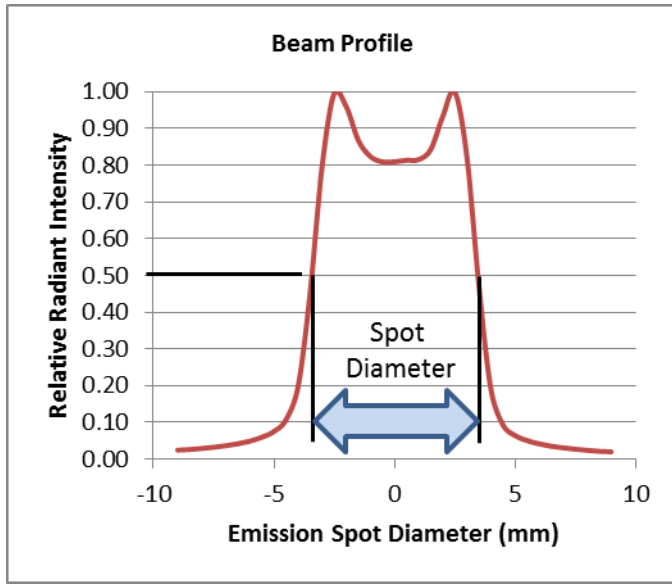

IR Camera Image of Emission Spot

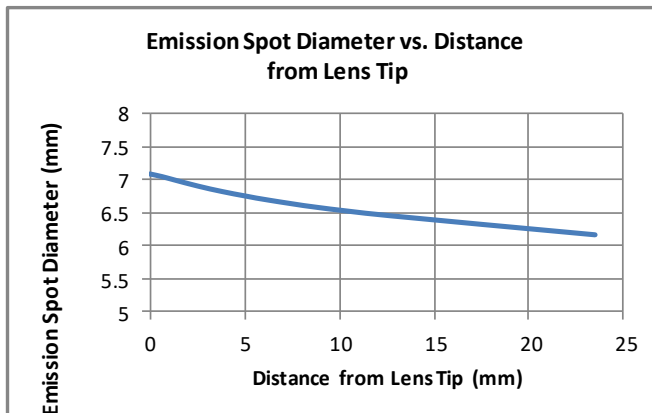

General Note  
TT Electronics reserves the right to make changes in product specification without notice or liability. All information is subject to TT Electronics' own data and is considered accurate at time of going to print.

TT Electronics | OPTEK Technology  
2900 E. Plano Pkwy, Plano, TX 75074 | Ph: +1 972 323 2200  
www.ttelectronics.com | sensors@ttelectronics.com