

TMC1620-TO DATASHEET

Dual N & P-Channel 60V Power MOSFET with low on-resistance and fast switching performance
High energy efficiency and good thermal performance.

+



+

+

+

APPLICATIONS

TMC1620-TO MOSFETs fit best with TRINAMIC bipolar stepper motor drivers:

TMC262: two-phase stepper motor driver; up to 3.5A (48V DC) or 4.5A (24V DC) RMS motor current with 4xTMC1620-TO.

TMC389: three-phase stepper motor driver; up to 3.5A (48V DC) or 4.5A (24V DC) RMS motor current with 3xTMC1620-TO.

PRODUCT SUMMARY

	N-CH	P-CH
BV_{DSS}	60V	-60V
$R_{DS(ON)}$	36m Ω	75m Ω
I_D	6.6A	-4.7A

DESCRIPTION

This advanced TMC1620-TO power MOSFET provides the designer with the best combination of fast switching, ruggedized device design, low on-resistance and cost-effectiveness. The highly energy efficient TMC1620 is intended for power conversion and power management applications that require high efficiency and power density.

The TO-252-4L 6.5x10mm package has a very good thermal performance.

FEATURES AND BENEFITS

N & P-Channel MOSFET Half Bridge Device

Simple Drive Requirement

Good Thermal Performance

Fast Switching Performance for quick motor reaction

TO-252-4L Package, 6.5x10mm

RoHS Compliant and Halogen-Free

TMC262 WITH 4X TMC1620-TO MOSFETS

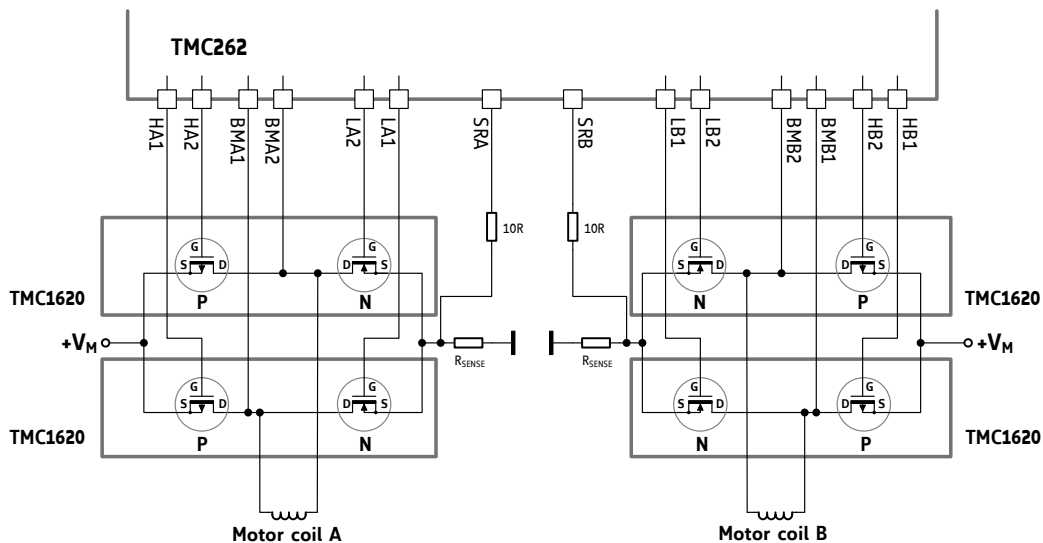

Order code	Description	Size
TMC1620-TO	N and P-channel enhancement mode power MOSFET	6.5 x 10 mm ²

Table of Contents

TABLE OF CONTENTS	2
1 PIN ASSIGNMENTS	3
2 ABSOLUTE MAXIMUM RATINGS	3
3 THERMAL DATA	3
4 ELECTRICAL CHARACTERISTICS	4
4.1 N-CH @T _J =25°C (UNLESS OTHERWISE SPECIFIED).....	4
4.1.1 Source-Drain Diode.....	4
4.2 P-CH @T _J =25°C (UNLESS OTHERWISE SPECIFIED)	4
4.2.1 Source-Drain Diode.....	5
5 N-CHANNEL DIAGRAMS	6
N-CHANNEL DIAGRAMS	7
6 P-CHANNEL DIAGRAMS	8
P-CHANNEL DIAGRAMS	9
7 PACKAGE MECHANICAL DATA	10
7.1 DIMENSIONAL DRAWINGS	10
7.2 PACKAGE MARKING INFORMATION AND PACKAGE CODE.....	10
8 DISCLAIMER	11
9 ESD SENSITIVE DEVICE	11
10 TABLE OF FIGURES	12
11 REVISION HISTORY	12

1 Pin Assignments

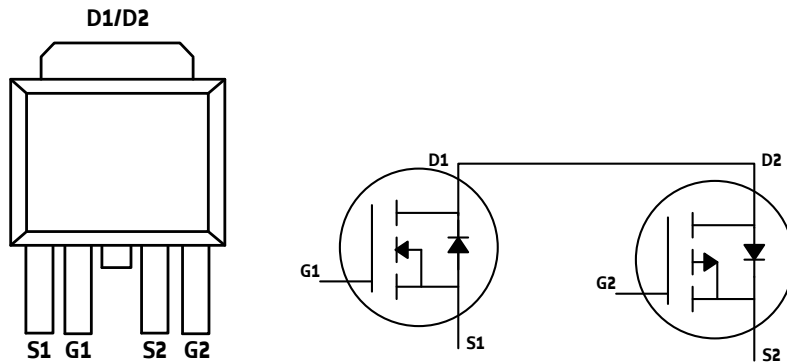

Figure 1.1 TMC1620-TO pin assignments

2 Absolute Maximum Ratings

The maximum ratings may not be exceeded under any circumstances. Operating the circuit at or near more than one maximum rating at a time for extended periods shall be avoided by application design.

Parameter	Symbol	N-channel	P-channel	Unit
Drain-Source Voltage	V_{DS}	60	-60	V
Gate-Source Voltage	V_{GS}	± 20	± 20	V
Continuous Drain Current* ²	$I_D @ T_A = 25^\circ\text{C}$	6.6	-4.7	A
Continuous Drain Current* ²	$I_D @ T_A = 70^\circ\text{C}$	5.3	-3.8	A
Pulsed Drain Current* ¹	I_{DM}	20	-20	A
Total Power Dissipation	$P_D @ T_A = 25^\circ\text{C}$	3.13		W
Storage Temperature Range	T_{STG}	-55 to 150		$^\circ\text{C}$
Operating Junction Temperature Range	T_J	-55 to 150		$^\circ\text{C}$

*¹ Pulse width is limited by maximum junction temperature.

*² N-CH, P-CH are same, mounted on 2oz FR4 board $t \leq 10\text{s}$.

3 Thermal Data

Parameter	Symbol	Value	Unit
Max. Thermal Resistance, Junction-case	Rthj-c	6	$^\circ\text{C}/\text{W}$
Max. Thermal Resistance, Junction-ambient*	Rthj-a	40	$^\circ\text{C}/\text{W}$

* Surface mounted on 1 in² copper pad of FR4 board, $t \leq 10\text{sec}$; $85^\circ\text{C}/\text{W}$ at steady state.

4 Electrical Characteristics

4.1 N-CH @T_j=25°C (unless otherwise specified)

Parameter	Symbol	Test Conditions	Min	Typ	Max	Unit
Drain-Source Breakdown Voltage	BV_{DSS}	$V_{GS}=0V, I_D=250\mu A$	60			V
Static Drain-Source On-Resistance*	$R_{DS(ON)}$	$V_{GS}=10V, I_D=6A$ $V_{GS}=4.5V, I_D=4A$			36 42	mΩ mΩ
Gate Threshold Voltage	$V_{GS(th)}$	$V_{DS}=V_{GS}, I_D=250\mu A$	1		3	V
Forward Transconductance	g_{fs}	$V_{DS}=10V, I_D=5A$		12.5		S
Drain-Source Leakage Current	I_{DSS}	$V_{DS}=48V, V_{GS}=0V$			10	mA
Gate-Source Leakage	I_{GSS}	$V_{DS}=0V, V_{GS}=\pm 20V$			±100	mA
Total Gate Charge*	Q_g	$I_D=5A$		12	19.2	nC
Gate-Source Charge	Q_{gs}	$V_{DS}=48V$		3		nC
Gate-Drain ("Miller") Charge	Q_{gd}	$V_{GS}=4.5V$		7		nC
Turn-on Delay Time	$t_{d(on)}$	$V_{DS}=30V$		7		ns
Rise Time	t_r	$I_D=5A$		10.5		ns
Turn-off Delay Time	$t_{d(off)}$	$R_G=3.3\Omega$		23		ns
Fall Time	t_f	$V_{GS}=10V$		5		ns
Input Capacitance	C_{iss}	$V_{GS}=0V$		975	1560	pF
Output Capacitance	C_{oss}	$V_{DS}=25V$		75		pF
Reverse Transfer Capacitance	C_{rfs}	$f=1.0MHz$		65		pF
Gate Resistance	R_g	$f=1.0MHz$		1.6	3.2	Ω

* Pulse test

4.1.1 Source-Drain Diode

Parameter	Symbol	Test Conditions	Min	Typ	Max	Unit
Forward On Voltage*	V_{SD}	$V_{GS}=0V, I_S=2.4A$			1.3	V
Reverse Recovery Time*	t_{rr}	$V_{GS}=0V, I_S=5A$		23		ns
Reverse Recovery Charge	Q_{rr}	$dI/dt=100A/\mu s$		22		nC

* Pulse test

4.2 P-CH @T_j=25°C (unless otherwise specified)

Parameter	Symbol	Test Conditions	Min	Typ	Max	Unit
Drain-Source Breakdown Voltage	BV_{DSS}	$V_{GS}=0V, I_D=-250\mu A$	-60			V
Static Drain-Source On-Resistance*	$R_{DS(ON)}$	$V_{GS}=-10V, I_D=-4A$ $V_{GS}=-4.5V, I_D=-3A$			75 90	mΩ mΩ
Gate Threshold Voltage	$V_{GS(th)}$	$V_{DS}=V_{GS}, I_D=-250\mu A$	-1		-3	V
Forward Transconductance	g_{fs}	$V_{DS}=-10V, I_D=-3A$		11		S
Drain-Source Leakage Current	I_{DSS}	$V_{DS}=-48V, V_{GS}=0V$			-10	mA
Gate-Source Leakage	I_{GSS}	$V_{DS}=0V, V_{GS}=\pm 20V$			±100	mA
Total Gate Charge*	Q_g	$I_D=-3A$		14	22.4	nC
Gate-Source Charge	Q_{gs}	$V_{DS}=-48V$		2.5		nC
Gate-Drain ("Miller") Charge	Q_{gd}	$V_{GS}=-4.5V$		8		nC
Turn-on Delay Time*	$t_{d(on)}$	$V_{DS}=-30V$		9		ns
Rise Time	t_r	$I_D=-3A$		9.5		ns
Turn-off Delay Time	$t_{d(off)}$	$R_G=3.3\Omega$		42		ns
Fall Time	t_f	$V_{GS}=-10V$		28		ns
Input Capacitance	C_{iss}	$V_{GS}=0V$		1000	1600	pF
Output Capacitance	C_{oss}	$V_{DS}=-25V$		125		pF
Reverse Transfer Capacitance	C_{rfs}	$f=1.0MHz$		95		pF
Gate Resistance	R_g	$f=1.0MHz$		1.6	3.2	Ω

* Pulse test

4.2.1 Source-Drain Diode

Parameter	Symbol	Test Conditions	Min	Typ	Max	Unit
Forward On Voltage*	V_{SD}	$V_{GS}=0V, I_S=-2.4A$			-1.3	V
Reverse Recovery Time	t_{rr}	$V_{GS}=0V, I_S=-3A$		30		ns
Reverse Recovery Charge	Q_{rr}	$dI/dt=-100A/\mu s$		45		nC

* Pulse test

5 N-Channel Diagrams

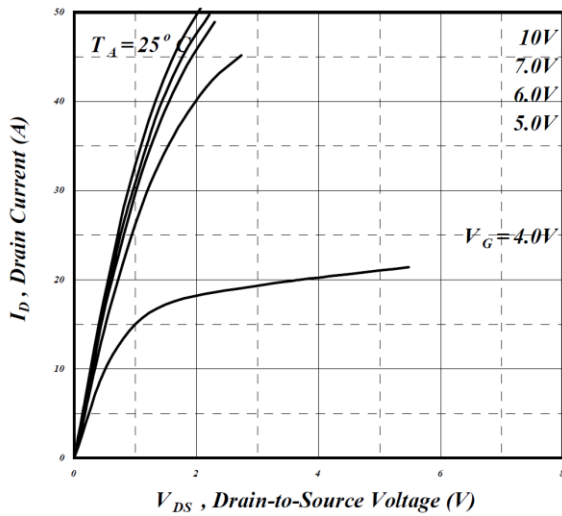

Figure 5.1 Typical output characteristics

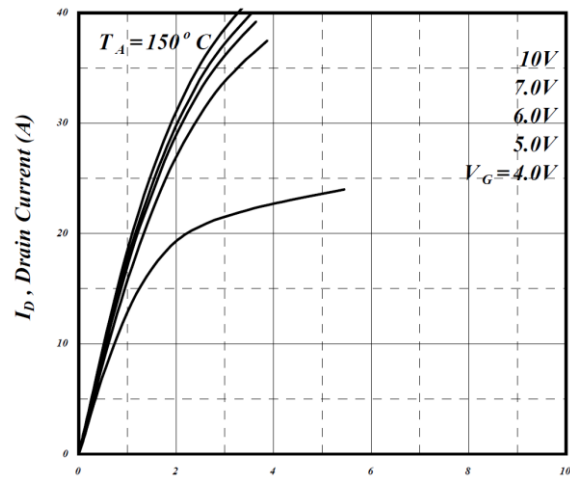

Figure 5.2 Typical output characteristics

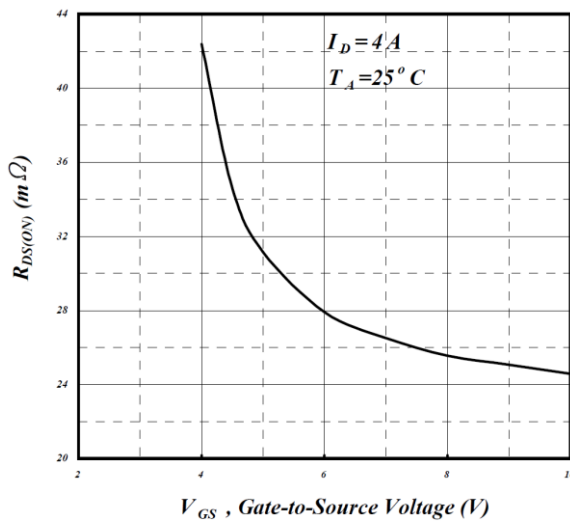

Figure 5.3 On-resistance v.s. gate voltage

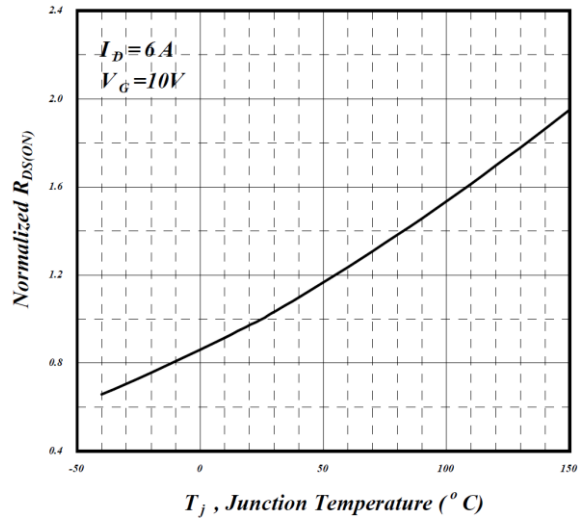

Figure 5.4 Normalized on-resistance v.s. junction temperature

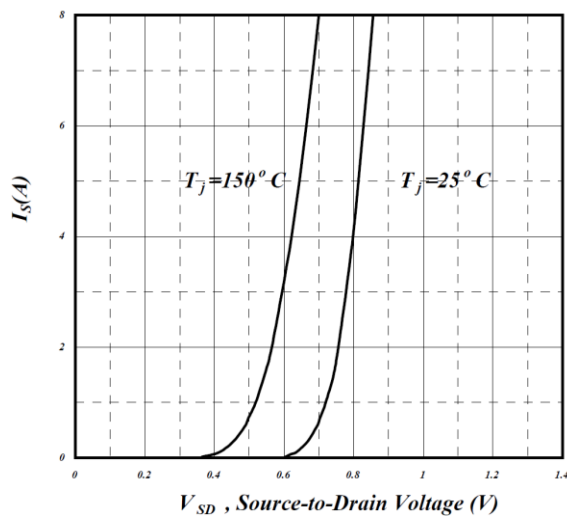

Figure 5.5 Forward characteristic of reverse diode

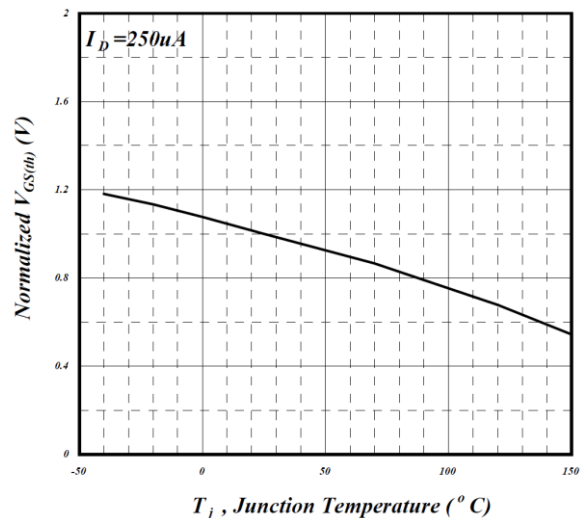

Figure 5.6 Gate threshold voltage v.s. junction temperature

N-Channel Diagrams

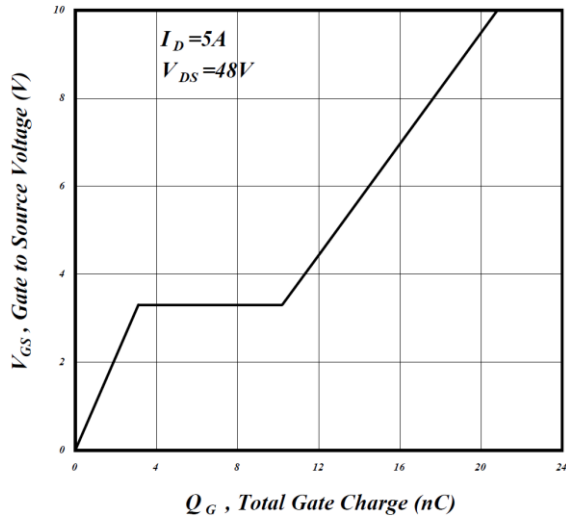

Figure 5.7 Gate charge characteristics

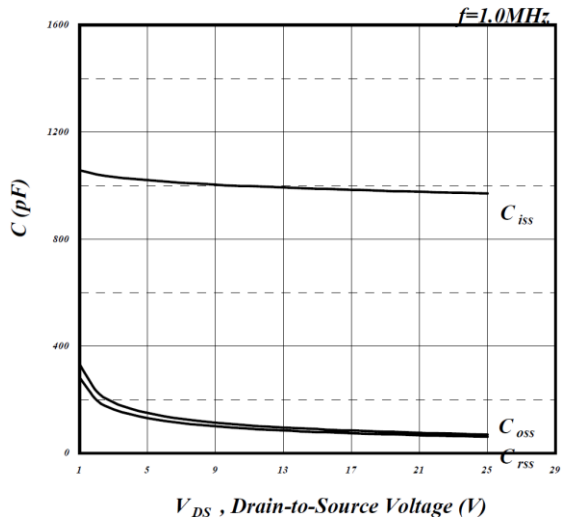

Figure 5.8 Typical capacitance characteristics

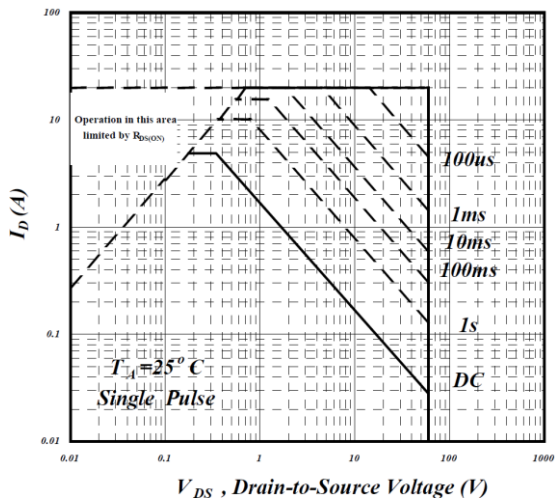

Figure 5.9 Maximum safe operating area

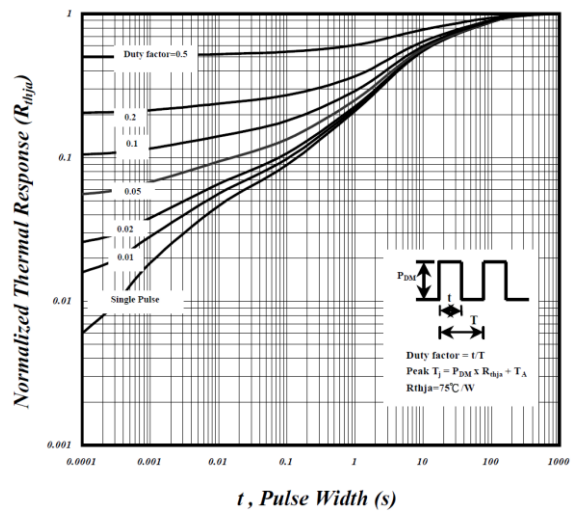

Figure 5.10 Effective transient thermal impedance

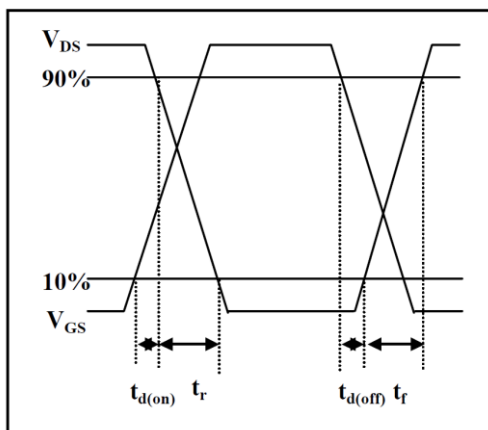

Figure 5.11 Switching time waveform

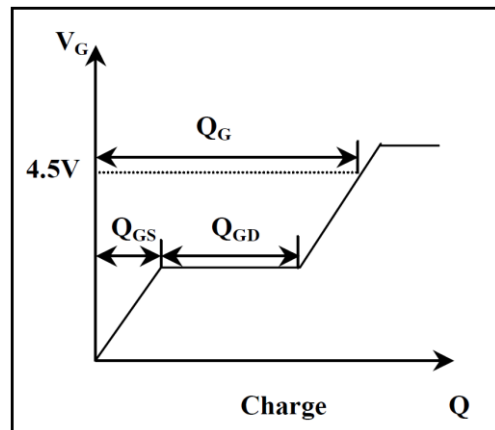

Figure 5.12 Gate charge waveform

6 P-Channel Diagrams

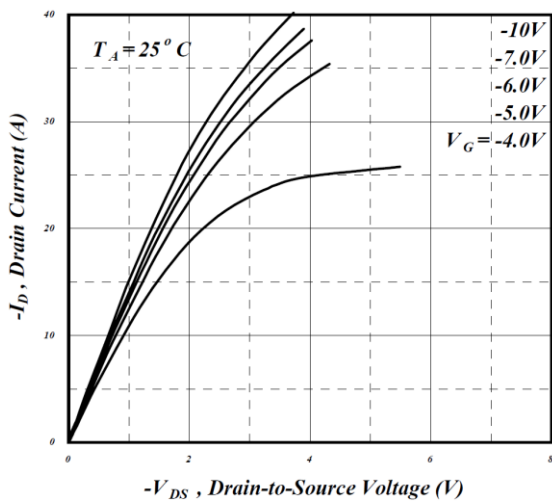

Figure 6.1 Typical output characteristics

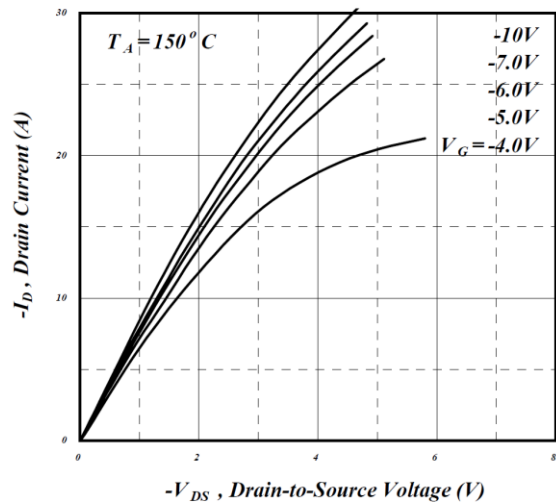

Figure 6.2 Typical output characteristics

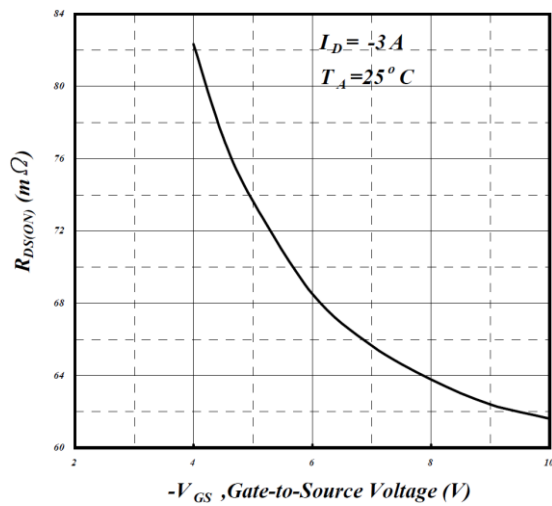

Figure 6.3 On-resistance v.s. gate voltage

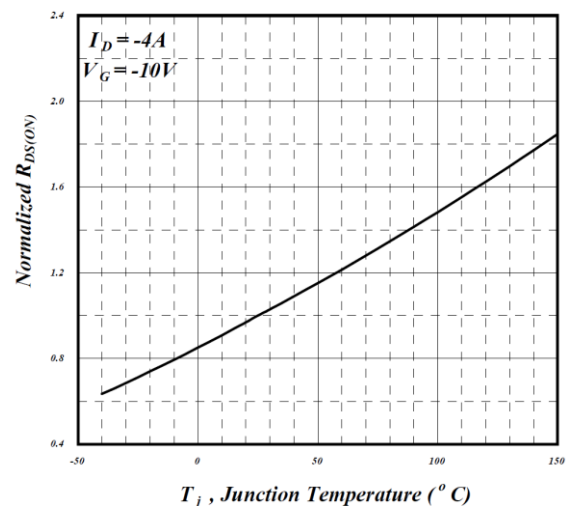

Figure 6.4 Normalized on-resistance v.s. junction temperature

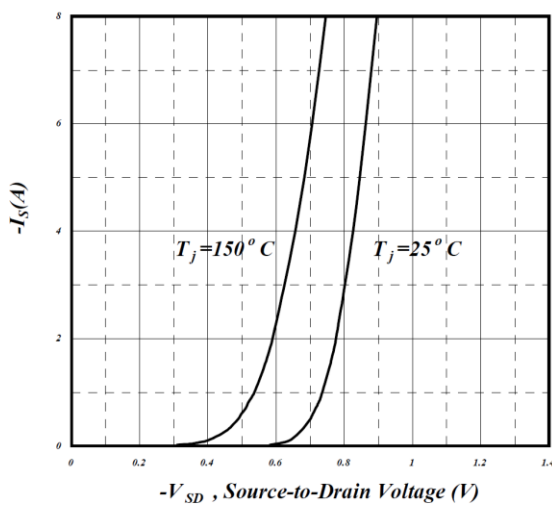

Figure 6.5 Forward characteristic of reverse diode

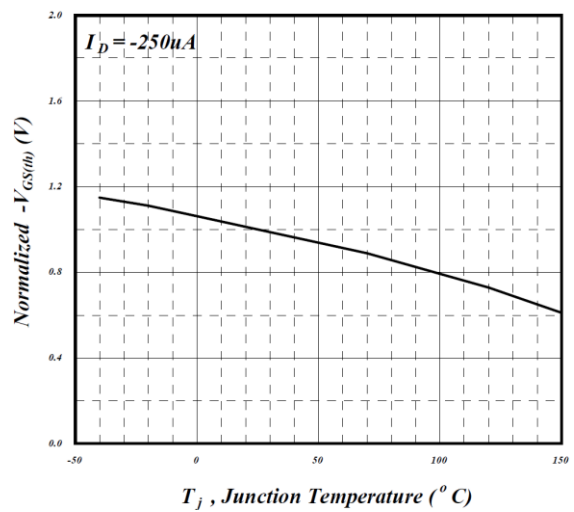

Figure 6.6 Gate Threshold voltage v.s. junction temperature

P-Channel Diagrams

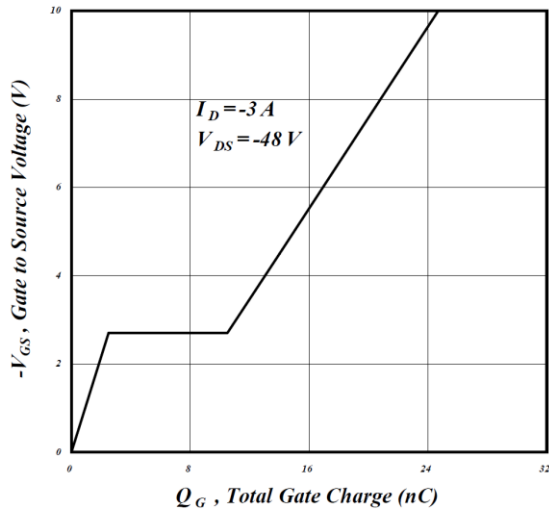

Figure 6.7 Gate charge characteristics

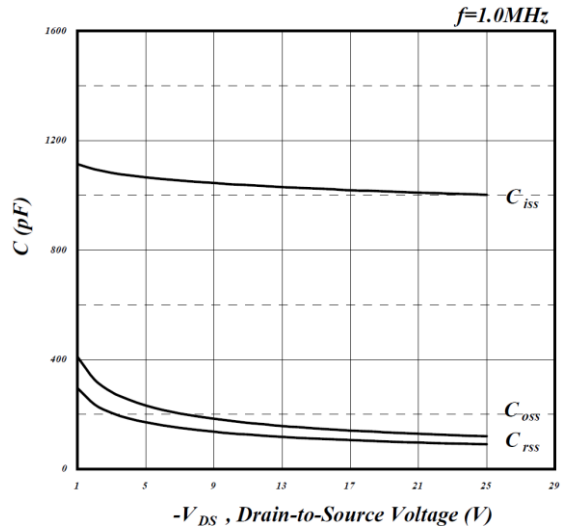

Figure 6.8 Typical capacitance characteristics

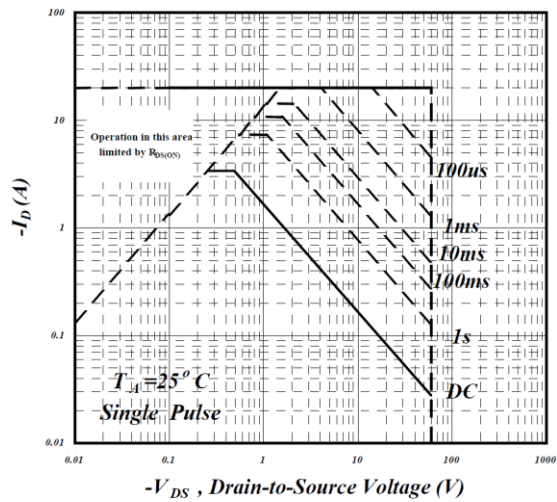

Figure 6.9 Maximum safe operating area

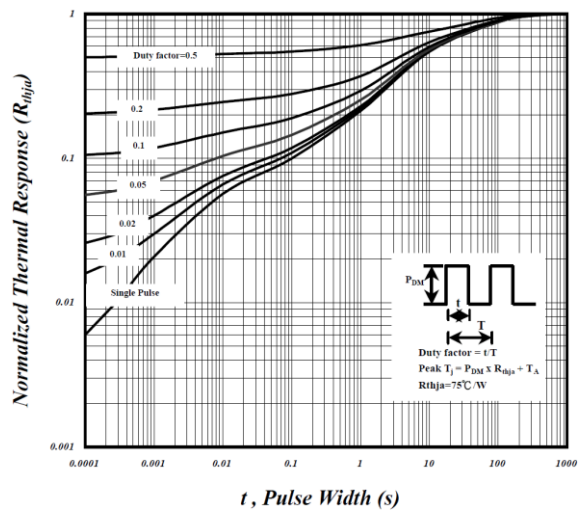

Figure 6.10 Effective transient thermal impedance

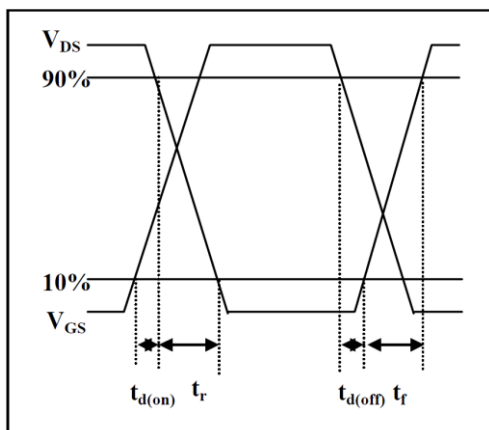

Figure 6.11 Switching time waveform

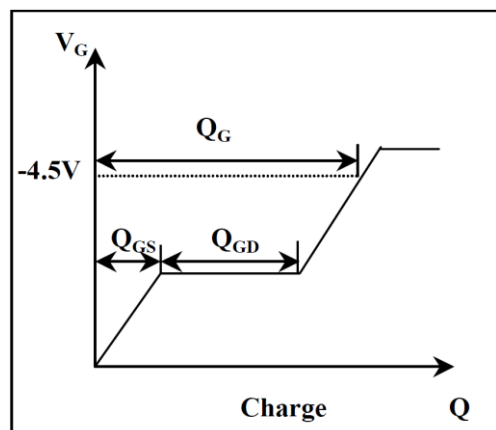

Figure 6.12 Gate charge waveform

7 Package Mechanical Data

7.1 Dimensional Drawings

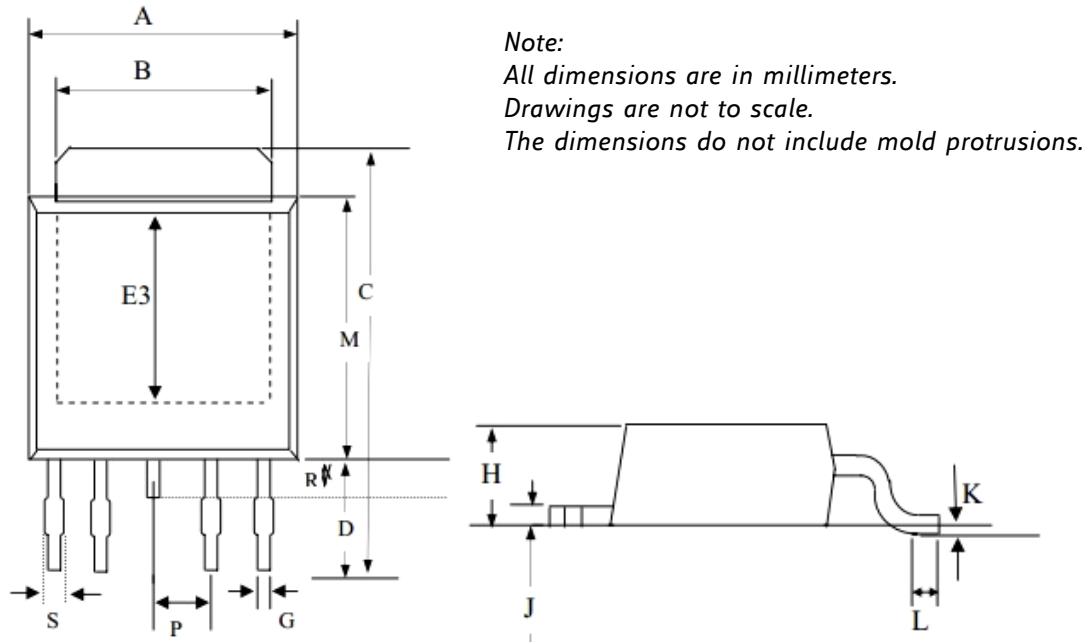

Figure 7.1 Dimensional drawings

Symbols	Min	Nom	Max
A	6.40	6.60	6.80
B	5.20	5.35	5.50
C	9.40	9.80	10.20
D	2.40	2.70	3.00
P	1.27 REF.		
S	0.50	0.65	0.80
E3	3.50	4.00	4.50
R	0.80	1.00	1.20
G	0.40	0.50	0.60
H	2.20	2.30	2.40
J	0.45	0.50	0.55
K	0.00	0.075	0.15
L	0.90	1.20	1.50
M	5.40	5.60	5.80

7.2 Package Marking Information and Package Code

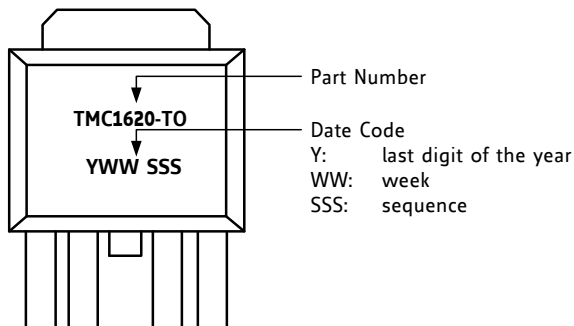

Figure 7.2 Package marking information

Device	Package	Temperature range	Code/ Marking
TMC1620	TO-252-4L package 6.5x10	-55° to +150°C	TMC1620-TO

8 Disclaimer

TRINAMIC Motion Control GmbH & Co. KG does not authorize or warrant any of its products for use in life support systems, without the specific written consent of TRINAMIC Motion Control GmbH & Co. KG. Life support systems are equipment intended to support or sustain life, and whose failure to perform, when properly used in accordance with instructions provided, can be reasonably expected to result in personal injury or death.

Information given in this data sheet is believed to be accurate and reliable. However no responsibility is assumed for the consequences of its use nor for any infringement of patents or other rights of third parties which may result from its use.

Specifications are subject to change without notice.

All trademarks used are property of their respective owners.

9 ESD Sensitive Device

The TMC1620-TO is an ESD sensitive CMOS device sensitive to electrostatic discharge. Take special care to use adequate grounding of personnel and machines in manual handling. After soldering the devices to the board, ESD requirements are more relaxed. Failure to do so can result in defect or decreased reliability.



10 Table of Figures

Figure 1.1 TMC1620 pin assignments.....	3
Figure 5.1 Typical output characteristics.....	6
Figure 5.2 Typical output characteristics.....	6
Figure 5.3 On-resistance v.s. gate voltage.....	6
Figure 5.4 Normalized on-resistance v.s. junction temperature	6
Figure 5.5 Forward characteristic of reverse diode	6
Figure 5.6 Gate threshold voltage v.s. junction temperature.....	6
Figure 5.7 Gate charge characteristics	7
Figure 5.8 Typical capacitance characteristics.....	7
Figure 5.9 Maximum safe operating area	7
Figure 5.10 Effective transient thermal impedance	7
Figure 5.11 Switching time waveform	7
Figure 5.12 Gate charge waveform.....	7
Figure 6.1 Typical output characteristics.....	8
Figure 6.2 Typical output characteristics.....	8
Figure 6.3 On-resistance v.s. gate voltage.....	8
Figure 6.4 Normalized on-resistance v.s. junction temperature	8
Figure 6.5 Forward characteristic of reverse diode	8
Figure 6.6 Gate Threshold voltage v.s. junction temperature	8
Figure 6.7 Gate charge characteristics	9
Figure 6.8 Typical capacitance characteristics.....	9
Figure 6.9 Maximum safe operating area	9
Figure 6.10 Effective transient thermal impedance	9
Figure 6.11 Switching time waveform	9
Figure 6.12 Gate charge waveform.....	9
Figure 7.1 Dimensional drawings	10
Figure 7.2 Package marking information	10

11 Revision History

Version	Date	Author SD - Sonja Dwersteg	Description
0.90	2014-FEB-26	SD	Initial version
1.00	2014-MAR-18	SD	New front picture, thermal data corrected
1.01	2014-MAY-12	SD	RMS motor current in combination with TMC262 and TMC389 updated.