

NTNS5K0P021Z

MOSFET – Single P-Channel, Small Signal, XDFN3, 0.62 x 0.42 x 0.4 mm -20 V, -127 mA

Features

- Low Profile Ultra Small Package, XDFN3 (0.62 x 0.42 x 0.4 mm) for Extremely Space-Constrained Applications
- -1.5 V Gate Drive
- These Devices are Pb-Free, Halogen Free/BFR Free and are RoHS Compliant

Applications

- Small Signal Load Switch
- High Speed Interfacing
- Level Shift

MAXIMUM RATINGS (T_J = 25°C unless otherwise stated)

Parameter			Symbol	Value	Unit
Drain-to-Source Voltage			V _{DSS}	20	V
Gate-to-Source Voltage			V _{GS}	±8	V
Continuous Drain Current (Note 1)	Steady State	T _A = 25°C	I _D	-127	mA
		T _A = 85°C		-91	
	t ≤ 5 s	T _A = 25°C		-146	
Power Dissipation (Note 1)	Steady State	T _A = 25°C	P _D	125	mW
	t ≤ 5 s			166	
Pulsed Drain Current	t _p = 10 μs		I _{DM}	-488	mA
Operating Junction and Storage Temperature			T _J , T _{STG}	-55 to 150	°C
Source Current (Body Diode) (Note 2)			I _S	200	mA
Lead Temperature for Soldering Purposes (1/8" from case for 10 s)			T _L	260	°C

Stresses exceeding those listed in the Maximum Ratings table may damage the device. If any of these limits are exceeded, device functionality should not be assumed, damage may occur and reliability may be affected.

1. Surface-mounted on FR4 board using the minimum recommended pad size, or 2 mm², 1 oz Cu.
2. Pulse Test: pulse width ≤ 300 μs, duty cycle ≤ 2%



ON Semiconductor®

www.onsemi.com

V _{(BR)DSS}	R _{DS(on)} MAX	I _D Max
-20 V	5.0 Ω @ -4.5 V	-127 mA
	5.5 Ω @ -3.3 V	
	6.0 Ω @ -2.5 V	
	7.0 Ω @ -1.8 V	
	10 Ω @ -1.5 V	

P-CHANNEL MOSFET

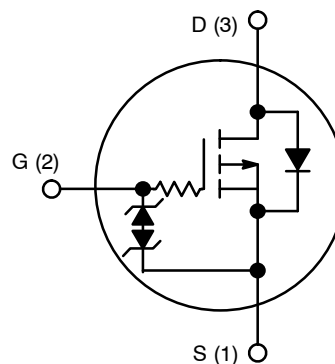

MARKING DIAGRAM



XDFN3
CASE 711BH

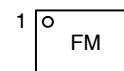

F = Specific Device Code
M = Date Code

ORDERING INFORMATION

Device	Package	Shipping†
NTNS5K0P021ZTCG	XDFN3 (Pb-Free)	8000 / Tape & Reel

†For information on tape and reel specifications, including part orientation and tape sizes, please refer to our Tape and Reel Packaging Specification Brochure, BRD8011/D.

NTNS5K0P021Z

THERMAL RESISTANCE RATINGS

Parameter	Symbol	Max	Unit
Junction-to-Ambient – Steady State (Note 3)	$R_{\theta JA}$	998	°C/W
Junction-to-Ambient – $t \leq 5$ s (Note 3)	$R_{\theta JA}$	751	

3. Surface-mounted on FR4 board using the minimum recommended pad size, or 2 mm², 1 oz Cu.

ELECTRICAL CHARACTERISTICS ($T_J = 25^\circ\text{C}$ unless otherwise stated)

Parameter	Symbol	Test Condition	Min	Typ	Max	Unit
-----------	--------	----------------	-----	-----	-----	------

OFF CHARACTERISTICS

Drain-to-Source Breakdown Voltage	$V_{(BR)DSS}$	$V_{GS} = 0\text{ V}, I_D = -250\ \mu\text{A}$	-20			V
Zero Gate Voltage Drain Current	I_{DSS}	$V_{GS} = 0\text{ V}, V_{DS} = -5\text{ V}$ $T_J = 25^\circ\text{C}$			-50	nA
Zero Gate Voltage Drain Current	I_{DSS}	$V_{GS} = 0\text{ V}, V_{DS} = -16\text{ V}$ $T_J = 25^\circ\text{C}$			-100	nA
Gate-to-Source Leakage Current	I_{GSS}	$V_{DS} = 0\text{ V}, V_{GS} = \pm 5\text{ V}$			± 100	nA

ON CHARACTERISTICS (Note 4)

Gate Threshold Voltage	$V_{GS(TH)}$	$V_{GS} = V_{DS}, I_D = -250\ \mu\text{A}$	-0.4		-1.0	V
Drain-to-Source On Resistance	$R_{DS(on)}$	$V_{GS} = -4.5\text{ V}, I_D = -100\text{ mA}$		2.1	5.0	Ω
		$V_{GS} = -3.3\text{ V}, I_D = -100\text{ mA}$		2.4	5.5	
		$V_{GS} = -2.5\text{ V}, I_D = -50\text{ mA}$		2.7	6.0	
		$V_{GS} = -1.8\text{ V}, I_D = -20\text{ mA}$		3.6	7.0	
		$V_{GS} = -1.5\text{ V}, I_D = -10\text{ mA}$		4.2	10	
Forward Transconductance	g_{FS}	$V_{DS} = -5\text{ V}, I_D = -125\text{ mA}$		0.35		S
Source-Drain Diode Voltage	V_{SD}	$V_{GS} = 0\text{ V}, I_S = -10\text{ mA}$		-0.6	-1.0	V

CHARGES & CAPACITANCES

Input Capacitance	C_{ISS}	$V_{GS} = 0\text{ V}, \text{freq} = 1\text{ MHz}, V_{DS} = -15\text{ V}$		12.8		pF
Output Capacitance	C_{OSS}			2.8		
Reverse Transfer Capacitance	C_{RSS}			2.0		

SWITCHING CHARACTERISTICS, $V_{GS} = 4.5\text{ V}$ (Note 4)

Turn-On Delay Time	$t_{d(ON)}$	$V_{GS} = -4.5\text{ V}, V_{DD} = -15\text{ V},$ $I_D = 200\text{ mA}, R_G = 2\ \Omega$		37		ns
Rise Time	t_r			71		
Turn-Off Delay Time	$t_{d(OFF)}$			280		
Fall Time	t_f			171		

4. Switching characteristics are independent of operating junction temperatures.

TYPICAL CHARACTERISTICS

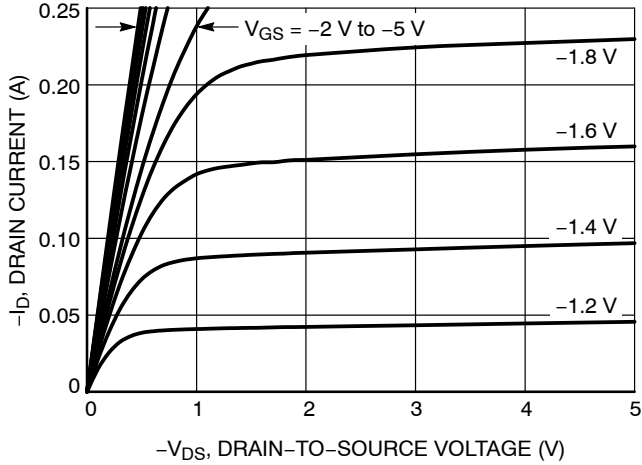

Figure 1. On-Region Characteristics

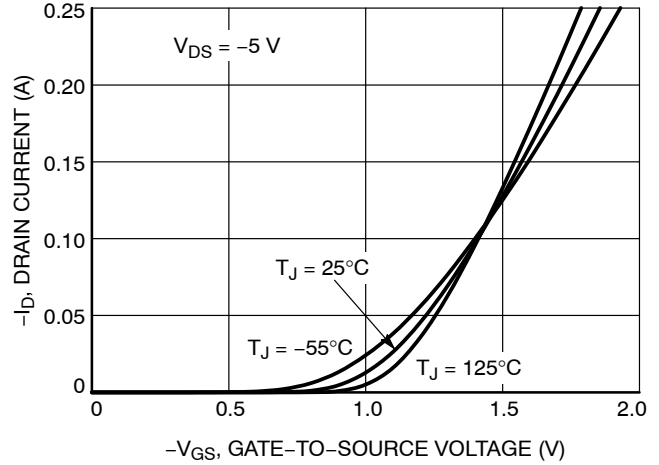

Figure 2. Transfer Characteristics

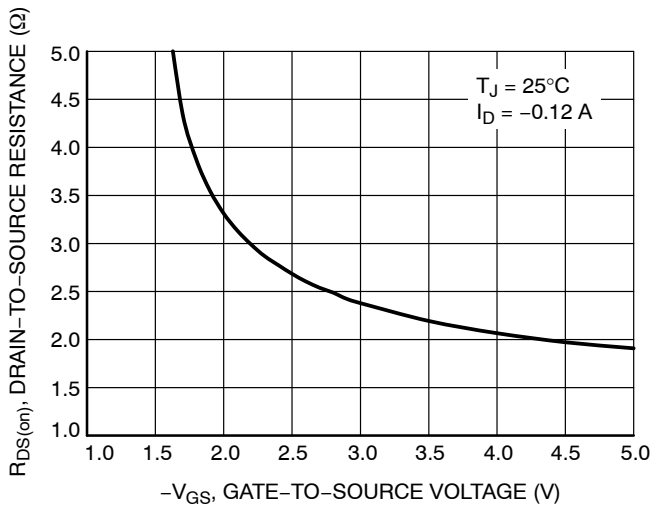

Figure 3. On-Resistance vs. Gate-to-Source Voltage

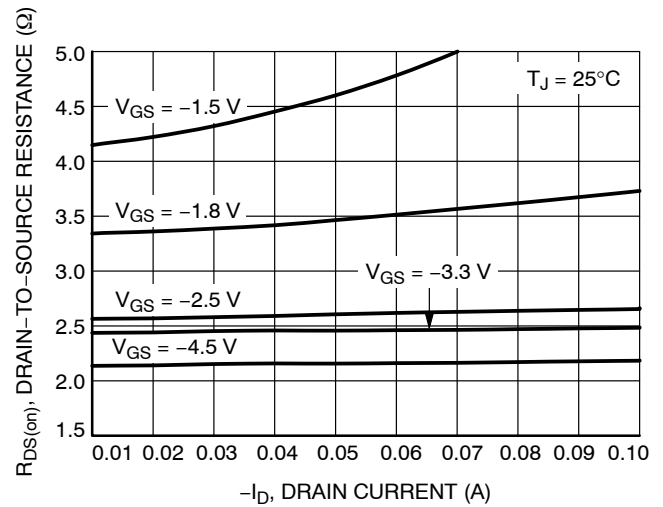

Figure 4. On-Resistance vs. Drain Current and Gate Voltage

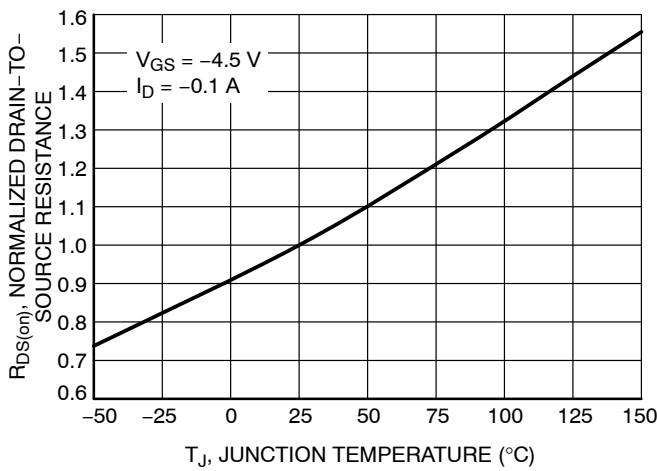

Figure 5. On-Resistance Variation with Temperature

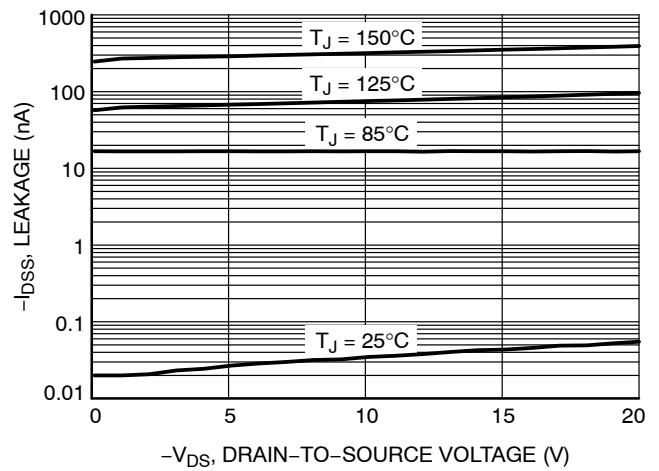
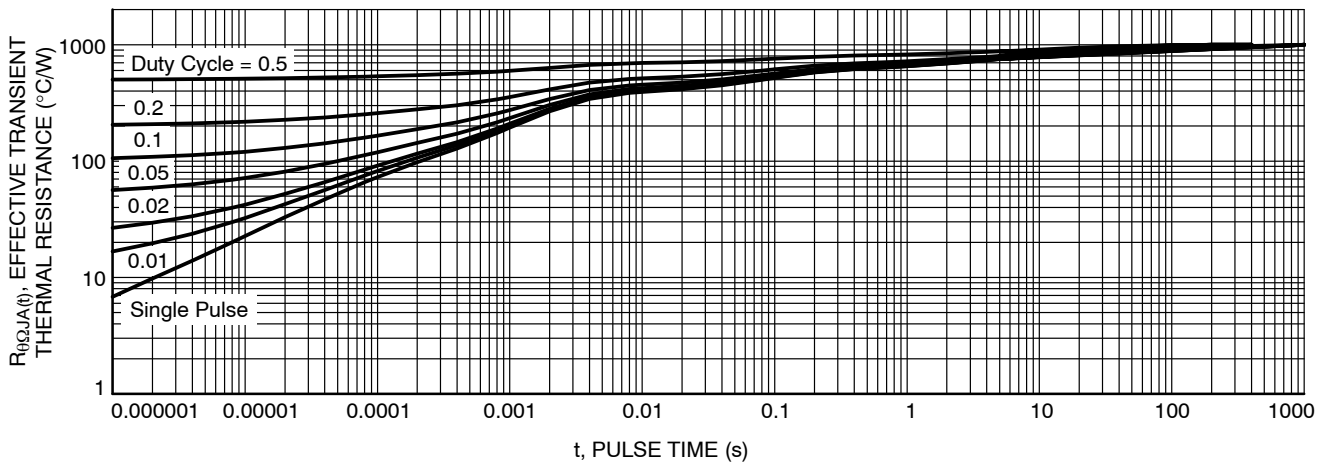
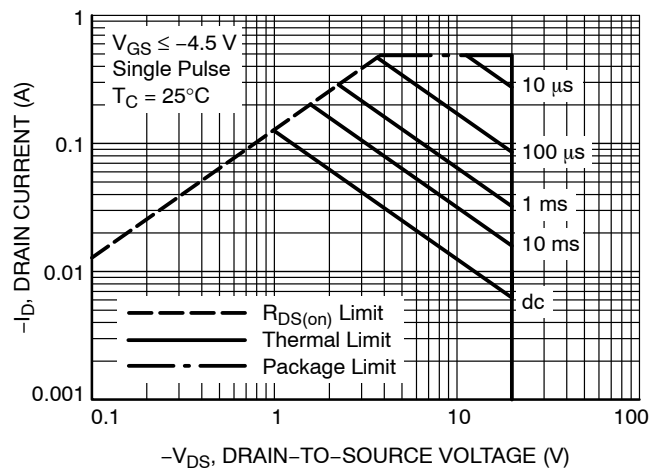
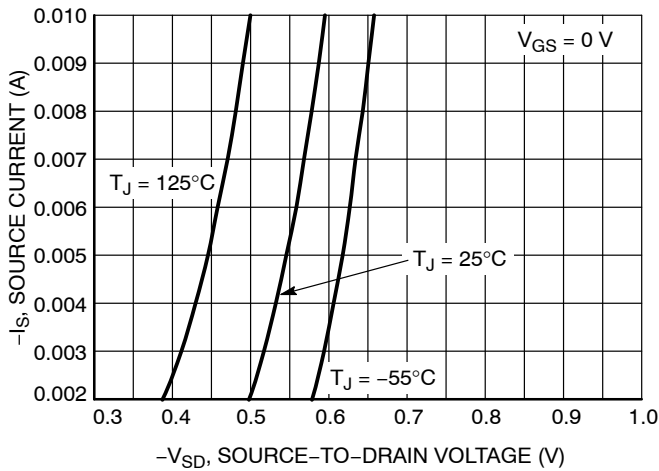
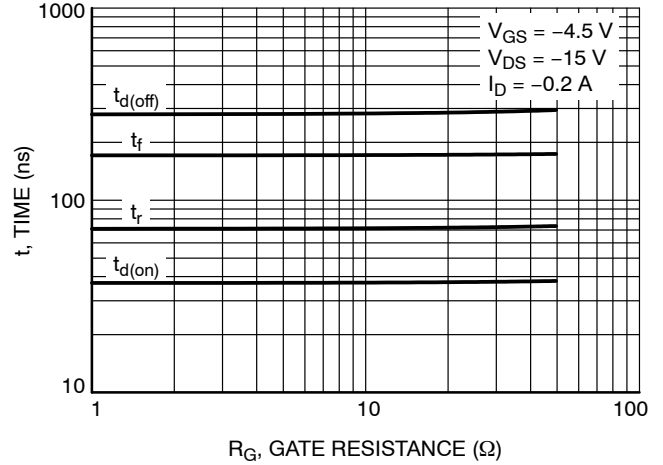
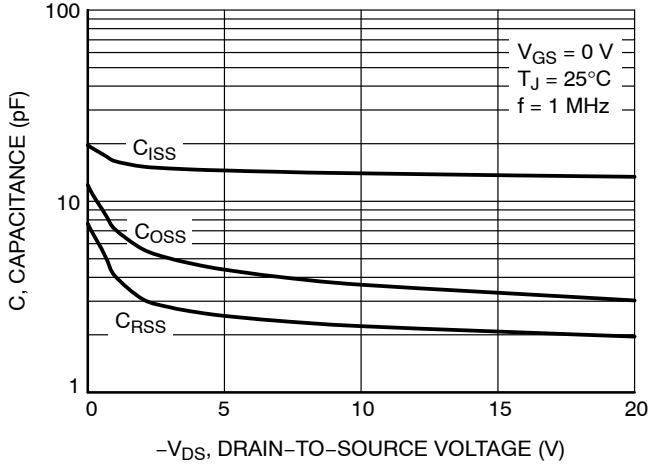
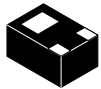

Figure 6. Drain-to-Source Leakage Current vs. Voltage

NTNS5K0P021Z

TYPICAL CHARACTERISTICS





SCALE 8:1

XDFN3 0.42x0.62, 0.3P
CASE 711BH
ISSUE A

DATE 29 APR 2018

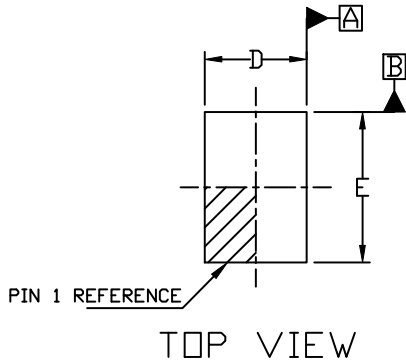

TOP VIEW

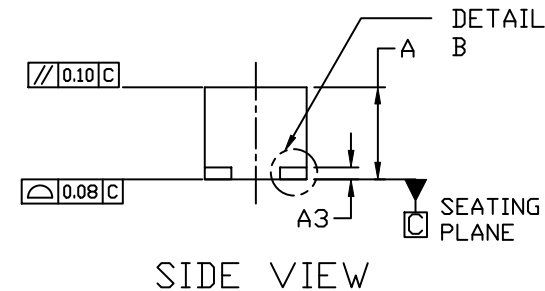

SIDE VIEW

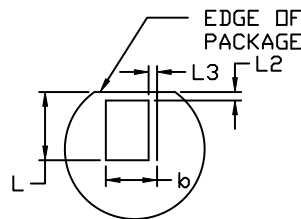

DETAIL A
 OPTIONAL
 CONSTRUCTION

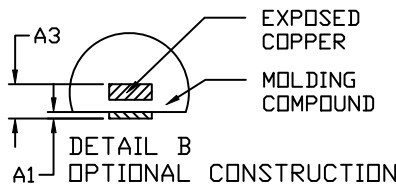

DETAIL B
 OPTIONAL CONSTRUCTION

DIM	MILLIMETERS		
	MIN.	NOM.	MAX.
A	0.33	0.38	0.43
A1	---	---	0.07
A3	0.13 REF		
b	0.05	0.11	0.17
b1	0.20	0.25	0.30
D	0.32	0.42	0.52
E	0.52	0.62	0.72
e	0.30 BSC		
e1	0.38 BSC		
L	0.09	0.15	0.21
L1	0.15	0.20	0.25
L2	---	---	0.03
L3	---	---	0.03
k	0.20 REF		

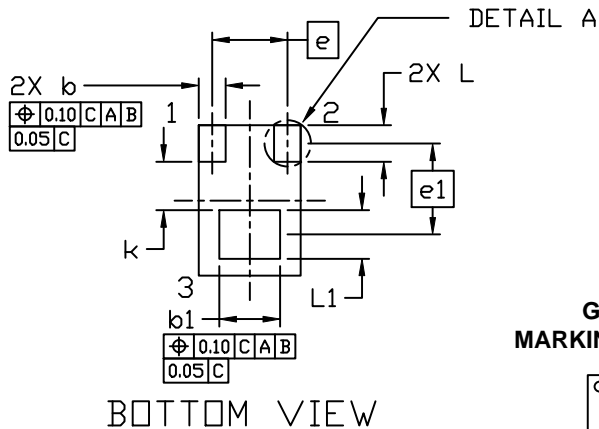

BOTTOM VIEW

GENERIC MARKING DIAGRAM*

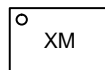

X = Specific Device Code
 M = Date Code

*This information is generic. Please refer to device data sheet for actual part marking. Pb-Free indicator, "G", may or not be present. Some products may not follow the Generic Marking.

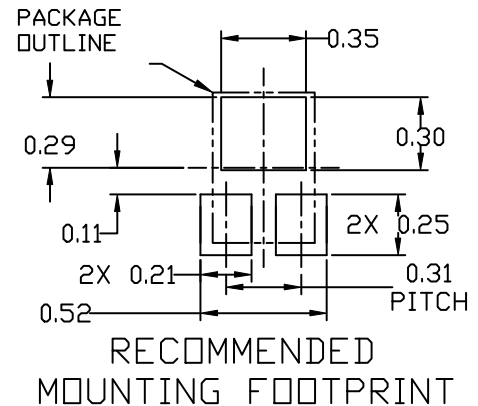

RECOMMENDED
 MOUNTING FOOTPRINT

DOCUMENT NUMBER:	98AON64946G	Electronic versions are uncontrolled except when accessed directly from the Document Repository. Printed versions are uncontrolled except when stamped "CONTROLLED COPY" in red.
DESCRIPTION:	XDFN3 0.42x0.62, 0.3P	PAGE 1 OF 1

ON Semiconductor and are trademarks of Semiconductor Components Industries, LLC dba ON Semiconductor or its subsidiaries in the United States and/or other countries. ON Semiconductor reserves the right to make changes without further notice to any products herein. ON Semiconductor makes no warranty, representation or guarantee regarding the suitability of its products for any particular purpose, nor does ON Semiconductor assume any liability arising out of the application or use of any product or circuit, and specifically disclaims any and all liability, including without limitation special, consequential or incidental damages. ON Semiconductor does not convey any license under its patent rights nor the rights of others.

onsemi, **Onsemi**, and other names, marks, and brands are registered and/or common law trademarks of Semiconductor Components Industries, LLC dba "**onsemi**" or its affiliates and/or subsidiaries in the United States and/or other countries. **onsemi** owns the rights to a number of patents, trademarks, copyrights, trade secrets, and other intellectual property. A listing of **onsemi**'s product/patent coverage may be accessed at www.onsemi.com/site/pdf/Patent-Marking.pdf. **onsemi** reserves the right to make changes at any time to any products or information herein, without notice. The information herein is provided "as-is" and **onsemi** makes no warranty, representation or guarantee regarding the accuracy of the information, product features, availability, functionality, or suitability of its products for any particular purpose, nor does **onsemi** assume any liability arising out of the application or use of any product or circuit, and specifically disclaims any and all liability, including without limitation special, consequential or incidental damages. Buyer is responsible for its products and applications using **onsemi** products, including compliance with all laws, regulations and safety requirements or standards, regardless of any support or applications information provided by **onsemi**. "Typical" parameters which may be provided in **onsemi** data sheets and/or specifications can and do vary in different applications and actual performance may vary over time. All operating parameters, including "Typicals" must be validated for each customer application by customer's technical experts. **onsemi** does not convey any license under any of its intellectual property rights nor the rights of others. **onsemi** products are not designed, intended, or authorized for use as a critical component in life support systems or any FDA Class 3 medical devices or medical devices with a same or similar classification in a foreign jurisdiction or any devices intended for implantation in the human body. Should Buyer purchase or use **onsemi** products for any such unintended or unauthorized application, Buyer shall indemnify and hold **onsemi** and its officers, employees, subsidiaries, affiliates, and distributors harmless against all claims, costs, damages, and expenses, and reasonable attorney fees arising out of, directly or indirectly, any claim of personal injury or death associated with such unintended or unauthorized use, even if such claim alleges that **onsemi** was negligent regarding the design or manufacture of the part. **onsemi** is an Equal Opportunity/Affirmative Action Employer. This literature is subject to all applicable copyright laws and is not for resale in any manner.

ADDITIONAL INFORMATION

TECHNICAL PUBLICATIONS:

Technical Library: www.onsemi.com/design/resources/technical-documentation
onsemi Website: www.onsemi.com

ONLINE SUPPORT: www.onsemi.com/support

For additional information, please contact your local Sales Representative at www.onsemi.com/support/sales