

BARBARA-G2-W

~40° wide beam compatible with LEDiL HEKLA

SPECIFICATION:

Dimensions	Ø 70.0 mm
Height	41.9 mm
Fastening	socket
ROHS compliant	yes ⓘ

MATERIALS:

Component	Type	Material	Colour	Finish	Coating
BARBARA-G2-W	Reflector	PC	metal		

ORDERING INFORMATION:





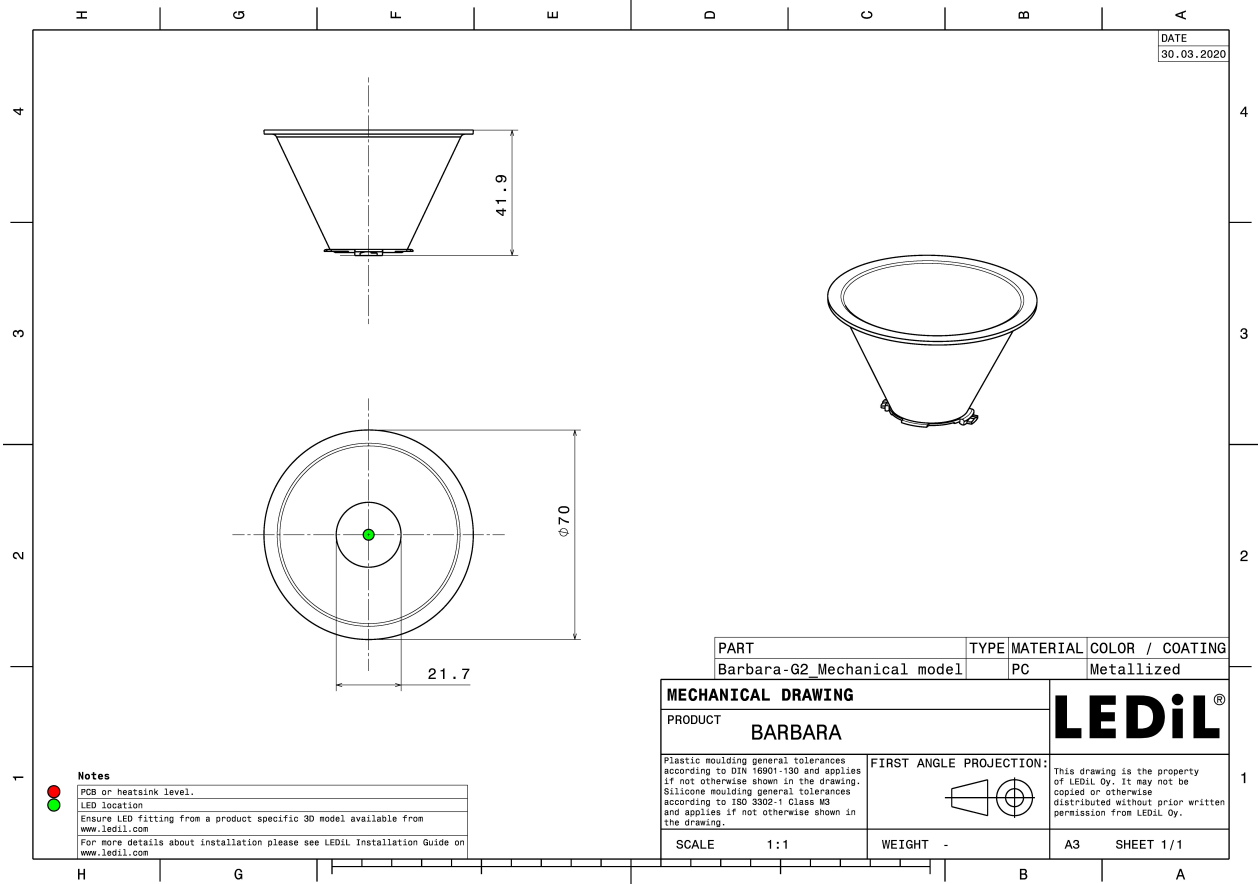



Component	Qty in box	MOQ	MPQ	Box weight (kg)
F16365_BARBARA-G2-W » Box size: 480 x 280 x 300 mm	252	90	18	4.8



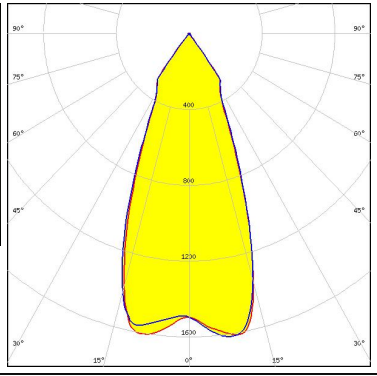

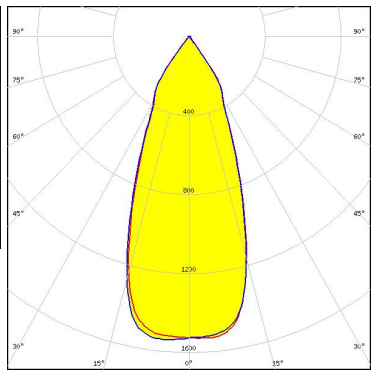

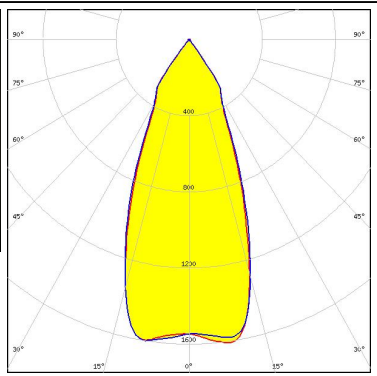

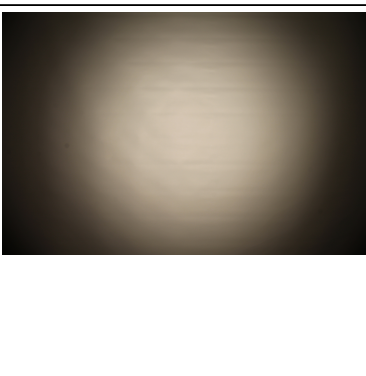
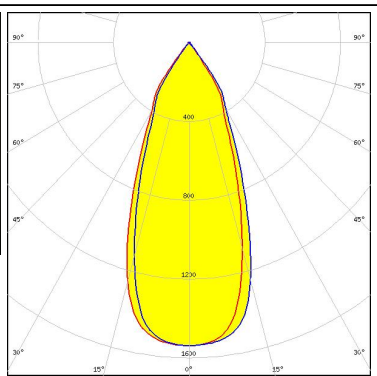

See also our general installation guide: www.ledil.com/installation_guide

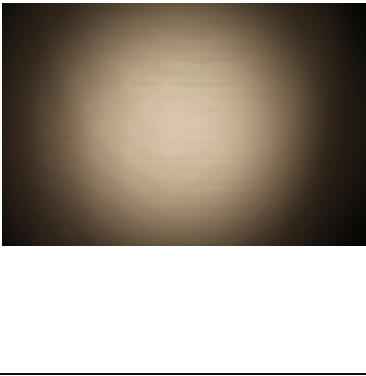
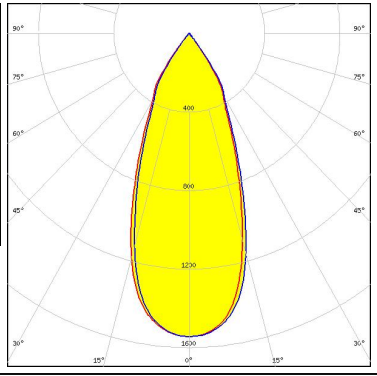

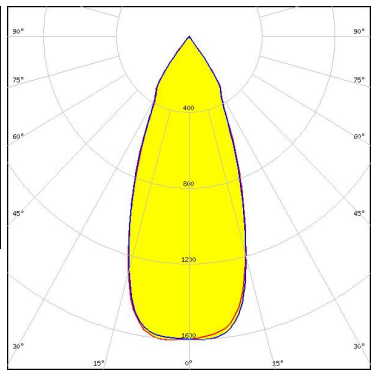

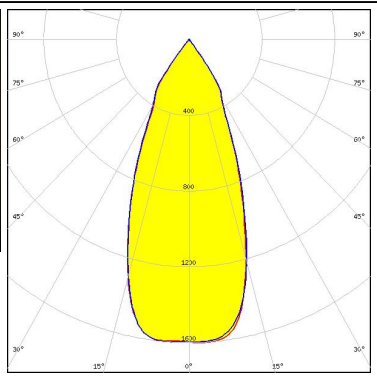

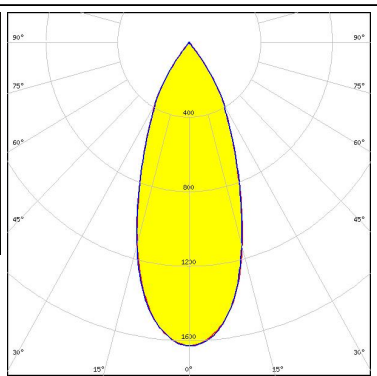

OPTICAL RESULTS (MEASURED):

<p></p> <p>LED V4 HD Gen 7 FWHM / FWTM 43.0° / 74.0° Efficiency 91 % Peak intensity 1.6 cd/m LEDs/each optic 1 Light colour White Required components: F15253_HEKLA-SOCKET-A</p>		
<p></p> <p>LED V4 HD Gen 7 FWHM / FWTM 42.0° / 74.0° Efficiency 86 % Peak intensity 1.5 cd/m LEDs/each optic 1 Light colour White Required components: F15253_HEKLA-SOCKET-A C14658_BARBARA-RZ-LENS</p>		
<p></p> <p>LED V6 HD Gen 7 FWHM / FWTM 42.0° / 74.0° Efficiency 91 % Peak intensity 1.6 cd/m LEDs/each optic 1 Light colour White Required components: F15255_HEKLA-SOCKET-C</p>		
<p></p> <p>LED V6 HD Gen 7 FWHM / FWTM 42.0° / 74.0° Efficiency 86 % Peak intensity 1.5 cd/m LEDs/each optic 1 Light colour White Required components: F15255_HEKLA-SOCKET-C C14658_BARBARA-RZ-LENS</p>		

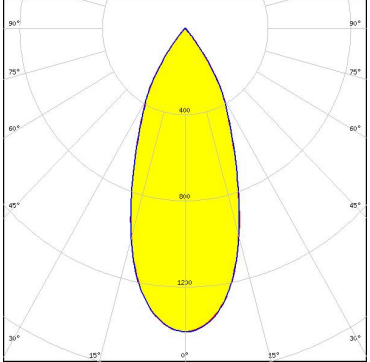
OPTICAL RESULTS (MEASURED):

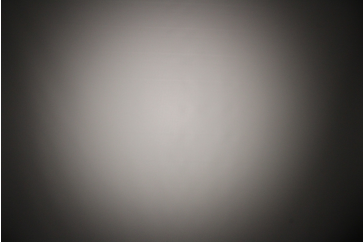
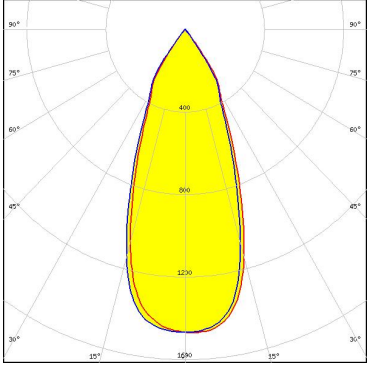
<p></p> <p>LED V9 HD Gen7 FWHM / FWTM 41.0° / 74.0° Efficiency 85 % Peak intensity 1.6 cd/m LEDs/each optic 1 Light colour White Required components: F15859_HEKLA-SOCKET-I C14658_BARBARA-RZ-LENS</p>		
<p></p> <p>LED V9 HD Gen7 FWHM / FWTM 42.0° / 73.0° Efficiency 88 % Peak intensity 1.6 cd/m LEDs/each optic 1 Light colour White Required components: F15256_HEKLA-SOCKET-D</p>		
<p></p> <p>LED V9 HD Gen7 FWHM / FWTM 43.0° / 74.0° Efficiency 91 % Peak intensity 1.6 cd/m LEDs/each optic 1 Light colour White Required components: F15859_HEKLA-SOCKET-I</p>		
<p></p> <p>LED Vesta DTW 13mm (21W) FWHM / FWTM 41.0° / 73.0° Efficiency 85 % Peak intensity 1.6 cd/m LEDs/each optic 1 Light colour Tunable White Required components: C16142_HEKLA-SOCKET-K Bender Wirth: 491 Typ L8</p>		

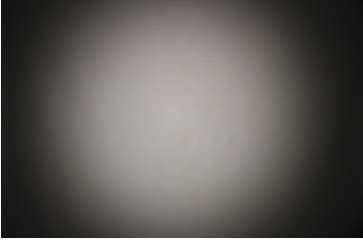
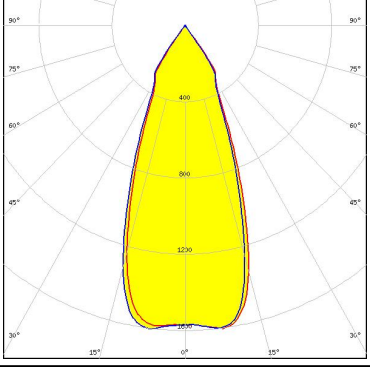
OPTICAL RESULTS (MEASURED):

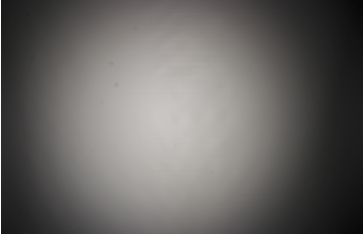
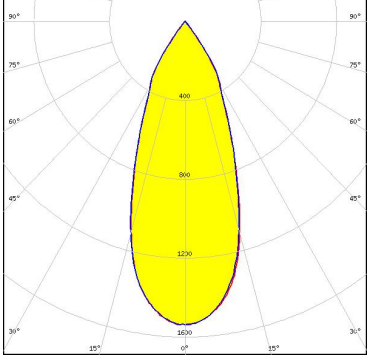
<p></p> <p>LED Vesta DTW 13mm (21W) FWHM / FWTM 42.0° / 75.0° Efficiency 80 % Peak intensity 1.4 cd/lm LEDs/each optic 1 Light colour Tunable White</p> <p>Required components: C16142_HEKLA-SOCKET-K C14658_BARBARA-RZ-LENS Bender Wirth: 491 Typ L8</p>		
<p></p> <p>LED Vesta TW 6mm DP FWHM / FWTM 41.0° / 73.0° Efficiency 80 % Peak intensity 1.5 cd/lm LEDs/each optic 1 Light colour White</p> <p>Required components: C16142_HEKLA-SOCKET-K C14658_BARBARA-RZ-LENS Bender Wirth: 504 Typ L8</p>		
<p></p> <p>LED Vesta TW 6mm DP FWHM / FWTM 41.0° / 73.0° Efficiency 85 % Peak intensity 1.6 cd/lm LEDs/each optic 1 Light colour White</p> <p>Required components: C16142_HEKLA-SOCKET-K Bender Wirth: 504 Typ L8</p>		
<p></p> <p>LED Vesta TW 9mm (12W) CSP FWHM / FWTM 40.0° / 73.0° Efficiency 82 % Peak intensity 1.5 cd/lm LEDs/each optic 1 Light colour White</p> <p>Required components: C16142_HEKLA-SOCKET-K C14658_BARBARA-RZ-LENS</p>		

OPTICAL RESULTS (MEASURED):

CITIZEN

LED CLC030 Series (Dim-To-Warm)
 FWHM / FWTM 42.0° / 73.0°
 Efficiency 84 %
 Peak intensity 1.5 cd/lm
 LEDs/each optic 1
 Light colour White
 Required components:
 C16142_HEKLA-SOCKET-K
 Bender Wirth: 436 Typ L8

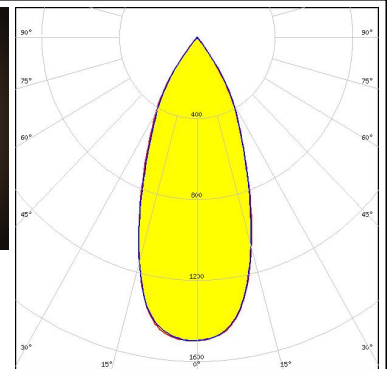
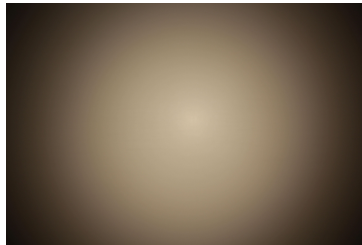

CITIZEN

LED CLC030 Series (Dim-To-Warm)
 FWHM / FWTM 43.0° / 75.0°
 Efficiency 79 %
 Peak intensity 1.3 cd/lm
 LEDs/each optic 1
 Light colour White
 Required components:
 C16142_HEKLA-SOCKET-K
 C14658_BARBARA-RZ-LENS
 Bender Wirth: 436 Typ L8

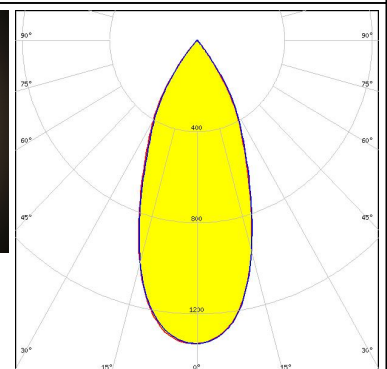
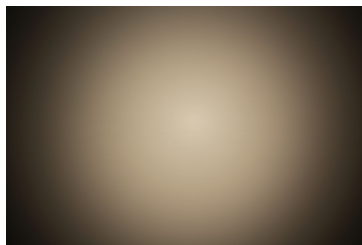

CITIZEN

LED CLL02x/CLU02x (LES10)
 FWHM / FWTM 42.0° / 74.0°
 Efficiency 91 %
 Peak intensity 1.7 cd/lm
 LEDs/each optic 1
 Light colour White
 Required components:
 F15255_HEKLA-SOCKET-C

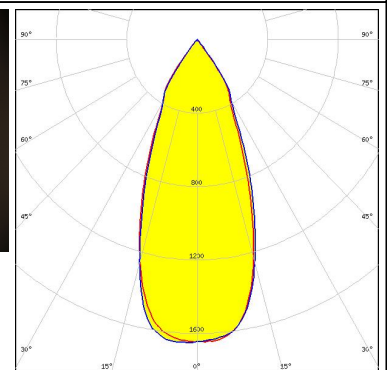
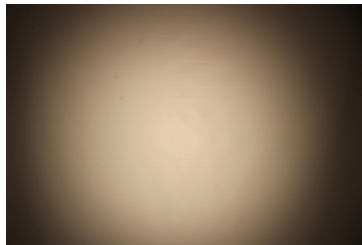

CITIZEN

LED CLL03x/CLU03x
 FWHM / FWTM 41.0° / 74.0°
 Efficiency 88 %
 Peak intensity 1.6 cd/lm
 LEDs/each optic 1
 Light colour White
 Required components:
 F15859_HEKLA-SOCKET-I

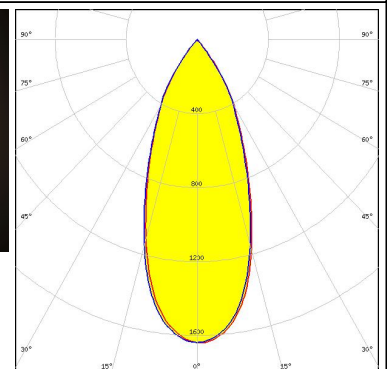
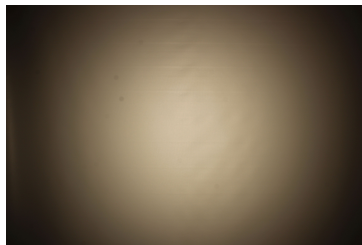

OPTICAL RESULTS (MEASURED):

CITIZEN

LED CLU700/701/702/703
 FWHM / FWTM 42.0° / 73.0°
 Efficiency 89 %
 Peak intensity 1.6 cd/lm
 LEDs/each optic 1
 Light colour White
 Required components:
 F15255_HEKLA-SOCKET-C

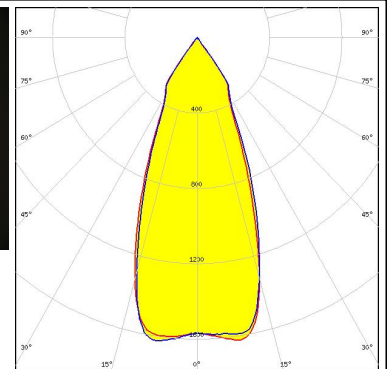
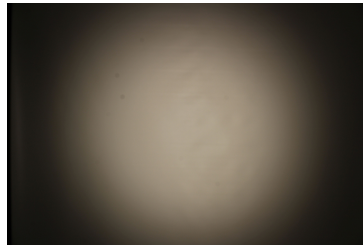

CITIZEN

LED LCN-C02B (Tunable White)
 FWHM / FWTM 41.0° / 73.0°
 Efficiency 80 %
 Peak intensity 1.5 cd/lm
 LEDs/each optic 1
 Light colour Tunable White
 Required components:
 C16142_HEKLA-SOCKET-K
 C14658_BARBARA-RZ-LENS
 Bender Wirth: 481 Typ L8

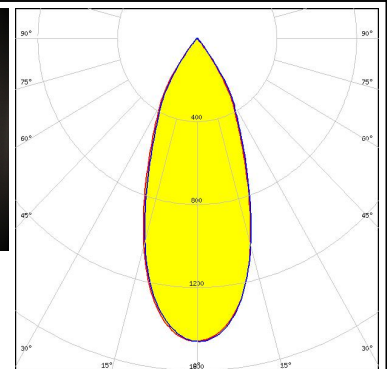
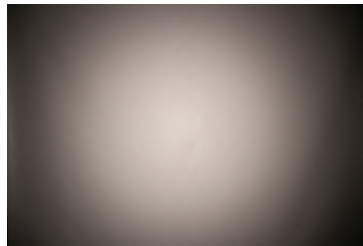

LED CMT14xx
 FWHM / FWTM 42.0° / 74.0°
 Efficiency 91 %
 Peak intensity 1.7 cd/lm
 LEDs/each optic 1
 Light colour White
 Required components:
 F15255_HEKLA-SOCKET-C

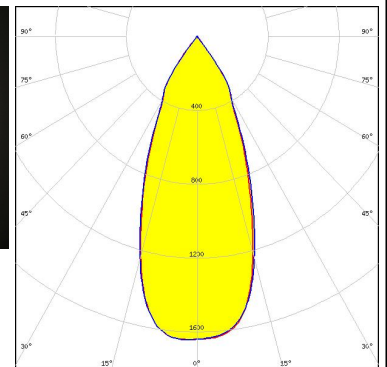
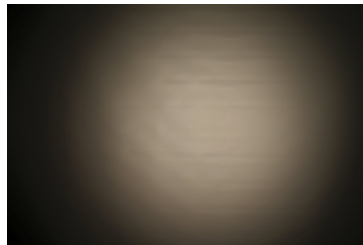

LED CMT19xx
 FWHM / FWTM 41.0° / 74.0°
 Efficiency 91 %
 Peak intensity 1.6 cd/lm
 LEDs/each optic 1
 Light colour White
 Required components:
 F15859_HEKLA-SOCKET-I

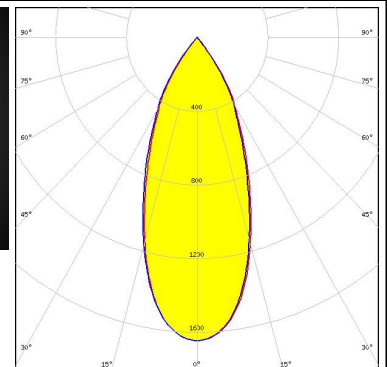
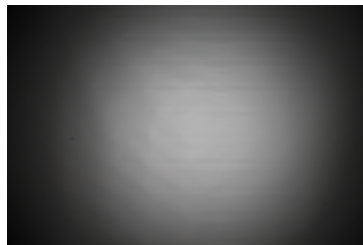

OPTICAL RESULTS (MEASURED):

CREE LED

LED CXA/B 13xx
 FWHM / FWTM 42.0° / 74.0°
 Efficiency 92 %
 Peak intensity 1.7 cd/m
 LEDs/each optic 1
 Light colour White
 Required components:
 F15956_HEKLA-SOCKET-J

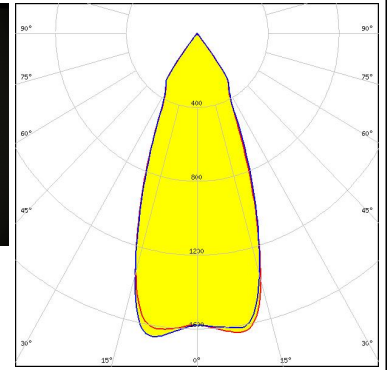
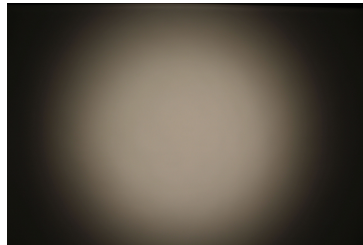

CREE LED

LED CXA/B 15xx
 FWHM / FWTM 42.0° / 74.0°
 Efficiency 92 %
 Peak intensity 1.7 cd/m
 LEDs/each optic 1
 Light colour White
 Required components:
 F15256_HEKLA-SOCKET-D

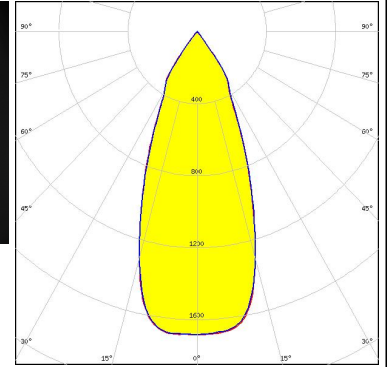

CREE LED

LED CXA/B 1816 & CXA/B 1820 & CXA 1850
 FWHM / FWTM 41.0° / 74.0°
 Efficiency 89 %
 Peak intensity 1.7 cd/m
 LEDs/each optic 1
 Light colour White
 Required components:
 F15254_HEKLA-SOCKET-B

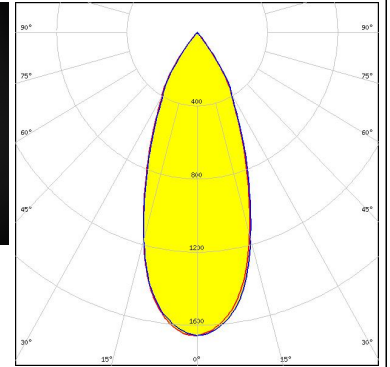
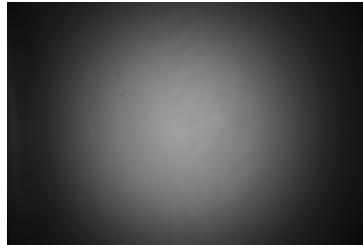



LUMILEDS

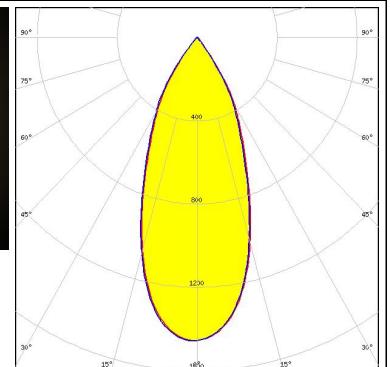
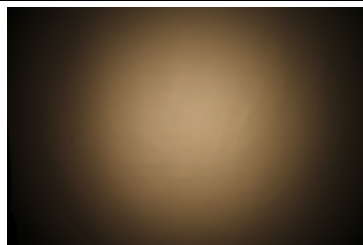

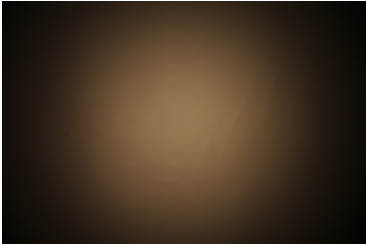
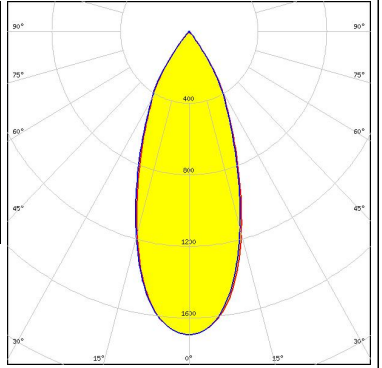

LED LUXEON CX Plus CoB L08 (Gen2)
 FWHM / FWTM 42.0° / 74.0°
 Efficiency 82 %
 Peak intensity 1.5 cd/m
 LEDs/each optic 1
 Light colour White
 Required components:
 C14658_BARBARA-RZ-LENS
 Bender Wirth: 637a Hekla

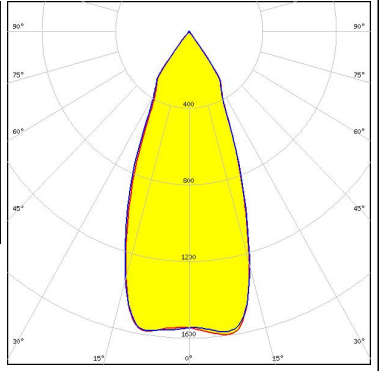
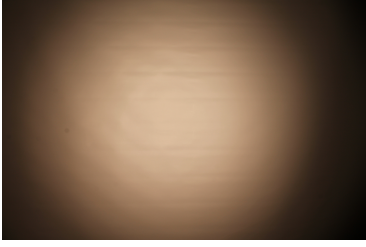
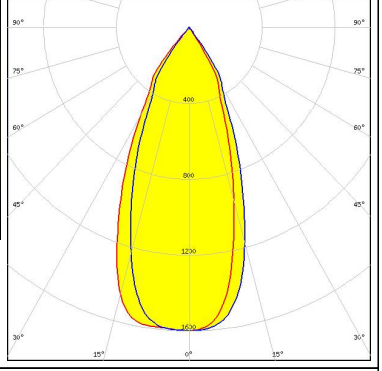
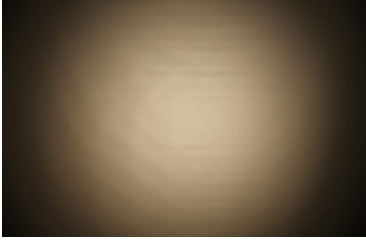
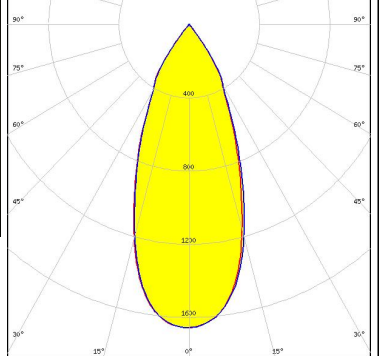



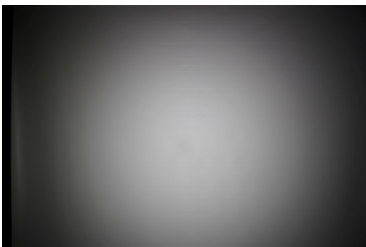
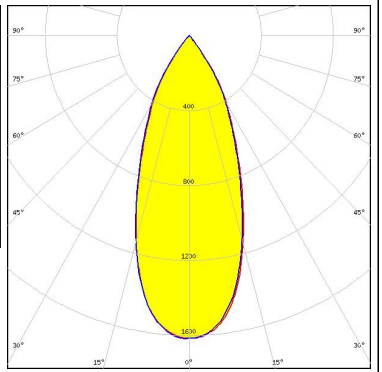

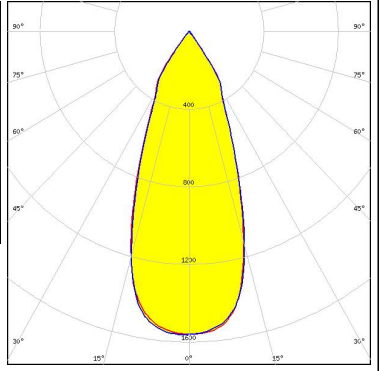
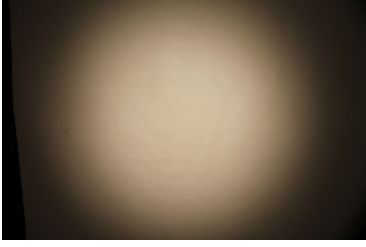
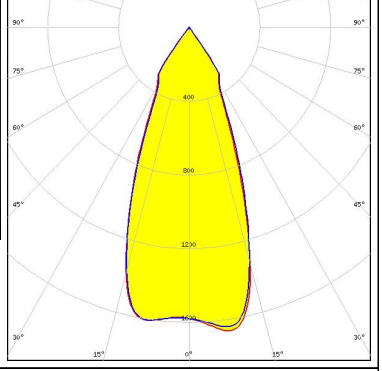

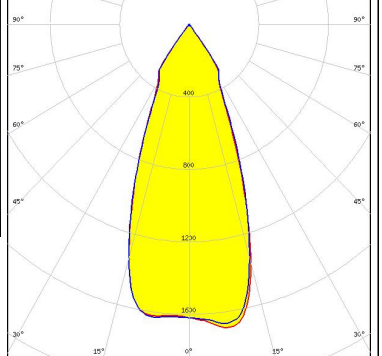
OPTICAL RESULTS (MEASURED):

<p>LUMILEDS</p> <p>LED LUXEON CX Plus CoB L08 (Gen2)</p> <p>FWHM / FWTM 40.0° / 73.0°</p> <p>Efficiency 89 %</p> <p>Peak intensity 1.7 cd/m</p> <p>LEDs/each optic 1</p> <p>Light colour White</p> <p>Required components: Bender Wirth: 637a Hekla</p>		
<p>LUMILEDS</p> <p>LED LUXEON CoB 1202HD</p> <p>FWHM / FWTM 42.0° / 74.0°</p> <p>Efficiency 90 %</p> <p>Peak intensity 1.6 cd/m</p> <p>LEDs/each optic 1</p> <p>Light colour White</p> <p>Required components: F15848_HEKLA-SOCKET-G</p>		
<p>LUMILEDS</p> <p>LED LUXEON CoB 1204HD</p> <p>FWHM / FWTM 43.0° / 74.0°</p> <p>Efficiency 91 %</p> <p>Peak intensity 1.6 cd/m</p> <p>LEDs/each optic 1</p> <p>Light colour White</p> <p>Required components: F15858_HEKLA-SOCKET-H</p>		
<p>LUMILEDS</p> <p>LED LUXEON CoB 1205HD</p> <p>FWHM / FWTM 41.0° / 74.0°</p> <p>Efficiency 90 %</p> <p>Peak intensity 1.7 cd/m</p> <p>LEDs/each optic 1</p> <p>Light colour White</p> <p>Required components: F15858_HEKLA-SOCKET-H</p>		

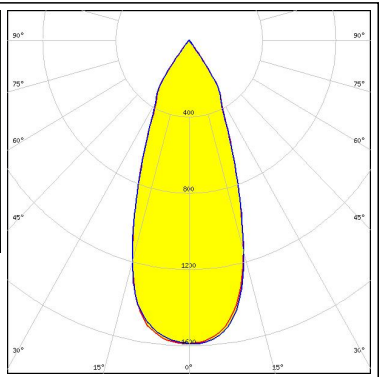
OPTICAL RESULTS (MEASURED):

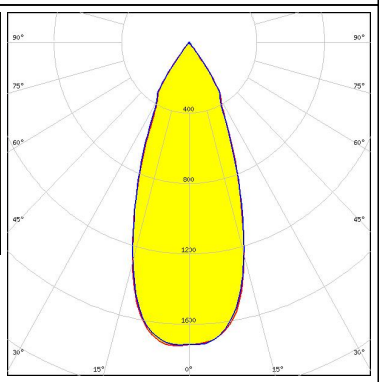
<p>LUMILEDS</p> <p>LED LUXEON CoB 1208</p> <p>FWHM / FWTM 41.0° / 73.0°</p> <p>Efficiency 87 %</p> <p>Peak intensity 1.6 cd/lm</p> <p>LEDs/each optic 1</p> <p>Light colour White</p> <p>Required components: Bender Wirth: 632a Hekla XL</p>		
<p>LUMILEDS</p> <p>LED LUXEON CX Plus CoB - HD S01H4</p> <p>FWHM / FWTM 40.0° / 73.0°</p> <p>Efficiency 83 %</p> <p>Peak intensity 1.6 cd/lm</p> <p>LEDs/each optic 1</p> <p>Light colour White</p> <p>Required components: C14658_BARBARA-RZ-LENS Bender Wirth: 634c Hekla</p>		
<p>LUMILEDS</p> <p>LED LUXEON CX Plus CoB - HD S01H4</p> <p>FWHM / FWTM 42.0° / 73.0°</p> <p>Efficiency 90 %</p> <p>Peak intensity 1.7 cd/lm</p> <p>LEDs/each optic 1</p> <p>Light colour White</p> <p>Required components: Bender Wirth: 634c Hekla</p>		
<p>LUMILEDS</p> <p>LED LUXEON CX Plus CoB - HD S01H6 / HD S02H6</p> <p>FWHM / FWTM 42.0° / 73.0°</p> <p>Efficiency 90 %</p> <p>Peak intensity 1.7 cd/lm</p> <p>LEDs/each optic 1</p> <p>Light colour White</p> <p>Required components: Bender Wirth: 634c Hekla</p>		

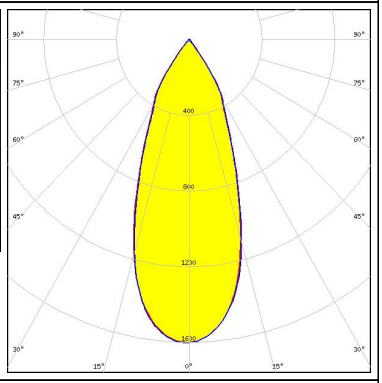
OPTICAL RESULTS (MEASURED):

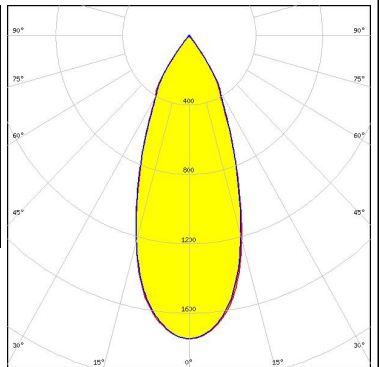
<p>LUMILEDS</p> <p>LED LUXEON CX Plus CoB - HD S01H6 / HD S02H6</p> <p>FWHM / FWTM 40.0° / 73.0°</p> <p>Efficiency 84 %</p> <p>Peak intensity 1.6 cd/lm</p> <p>LEDs/each optic 1</p> <p>Light colour White</p> <p>Required components: C14658_BARBARA-RZ-LENS Bender Wirth: 634c Hekla</p>		
<p>LUMILEDS</p> <p>LED LUXEON CX Plus CoB - HD S04H9</p> <p>FWHM / FWTM 41.0° / 72.0°</p> <p>Efficiency 91 %</p> <p>Peak intensity 1.7 cd/lm</p> <p>LEDs/each optic 1</p> <p>Light colour White</p> <p>Required components: Bender Wirth: 634c Hekla</p>		
<p>LUMILEDS</p> <p>LED LUXEON CX Plus CoB - HD S04H9</p> <p>FWHM / FWTM 40.0° / 72.0°</p> <p>Efficiency 84 %</p> <p>Peak intensity 1.6 cd/lm</p> <p>LEDs/each optic 1</p> <p>Light colour White</p> <p>Required components: C14658_BARBARA-RZ-LENS Bender Wirth: 634c 3Hook</p>		
<p>LUMILEDS</p> <p>LED LUXEON CX Plus CoB L04 / L05 (Gen2)</p> <p>FWHM / FWTM 40.0° / 72.0°</p> <p>Efficiency 89 %</p> <p>Peak intensity 1.7 cd/lm</p> <p>LEDs/each optic 1</p> <p>Light colour White</p> <p>Required components: Bender Wirth: 637a Hekla</p>		

OPTICAL RESULTS (MEASURED):

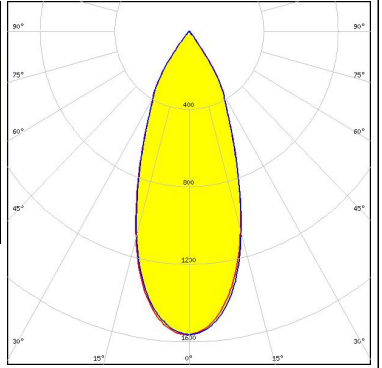
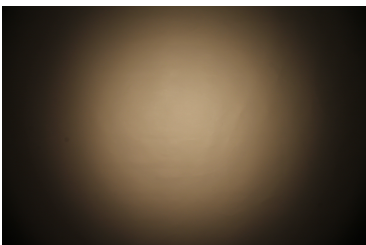
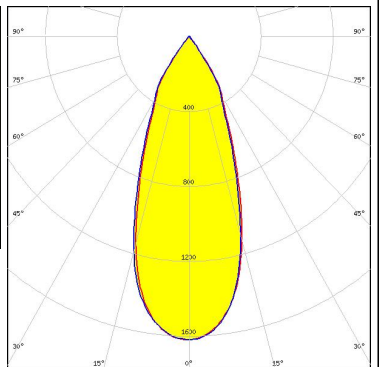
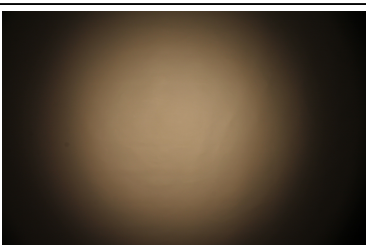
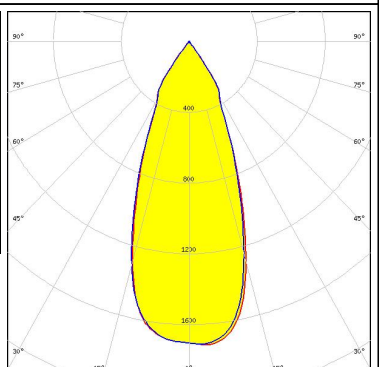
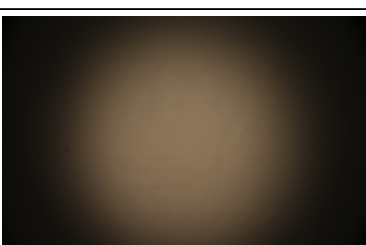
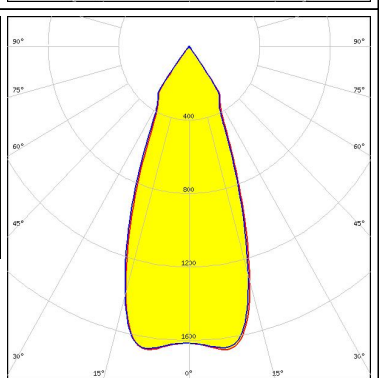
<p>LUMILEDS</p> <p>LED LUXEON CX Plus CoB L04 / L05 (Gen2)</p> <p>FWHM / FWTM 40.0° / 73.0°</p> <p>Efficiency 83 %</p> <p>Peak intensity 1.6 cd/lm</p> <p>LEDs/each optic 1</p> <p>Light colour White</p> <p>Required components: C14658_BARBARA-RZ-LENS Bender Wirth: 637a Hekla</p>		
<p>LUMILEDS</p> <p>LED LUXEON CX Plus CoB M02 / M03 (Gen2)</p> <p>FWHM / FWTM 39.0° / 72.0°</p> <p>Efficiency 84 %</p> <p>Peak intensity 1.6 cd/lm</p> <p>LEDs/each optic 1</p> <p>Light colour White</p> <p>Required components: C14658_BARBARA-RZ-LENS Bender Wirth: 641a Hekla</p>		
<p>LUMILEDS</p> <p>LED LUXEON CX Plus CoB M02 / M03 (Gen2)</p> <p>FWHM / FWTM 41.0° / 73.0°</p> <p>Efficiency 90 %</p> <p>Peak intensity 1.7 cd/lm</p> <p>LEDs/each optic 1</p> <p>Light colour White</p> <p>Required components: Bender Wirth: 641a Hekla</p>		
<p>LUMILEDS</p> <p>LED LUXEON CX Plus CoB S01 (Gen2)</p> <p>FWHM / FWTM 42.0° / 73.0°</p> <p>Efficiency 90 %</p> <p>Peak intensity 1.7 cd/lm</p> <p>LEDs/each optic 1</p> <p>Light colour White</p> <p>Required components: Bender Wirth: 634c Hekla</p>		

OPTICAL RESULTS (MEASURED):

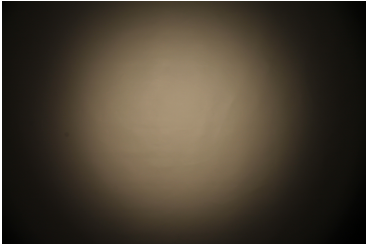
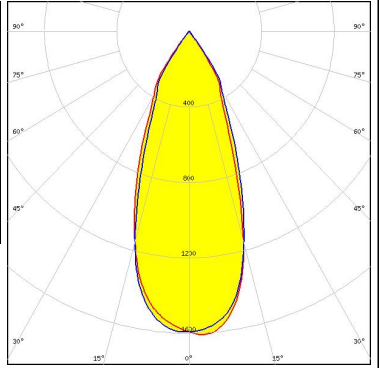
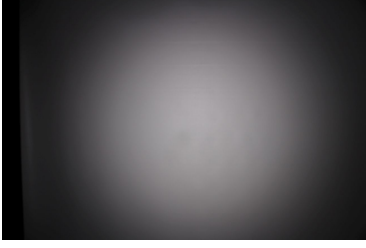
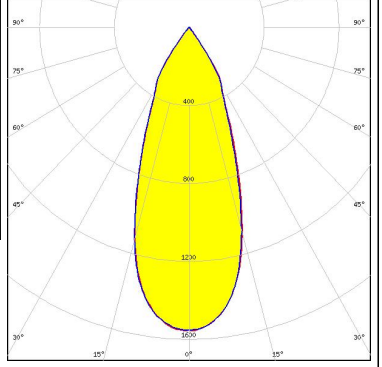
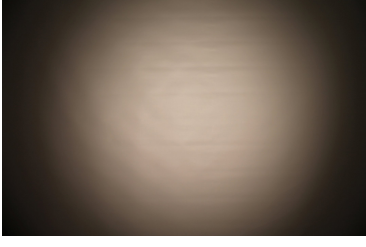
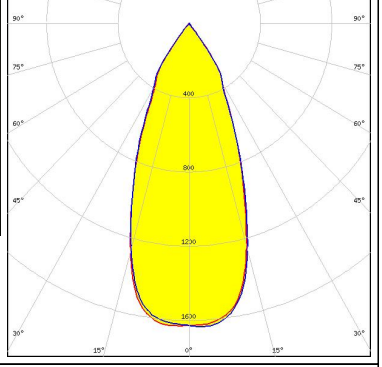
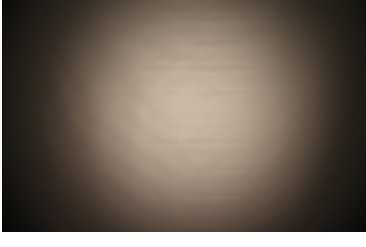
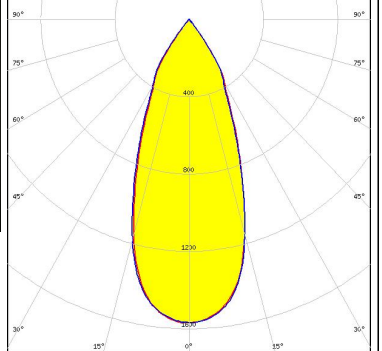
<p>LUMILEDS</p> <p>LED LUXEON CX Plus CoB S01 (Gen2)</p> <p>FWHM / FWTM 40.0° / 72.0°</p> <p>Efficiency 84 %</p> <p>Peak intensity 1.6 cd/m</p> <p>LEDs/each optic 1</p> <p>Light colour White</p> <p>Required components: C14658_BARBARA-RZ-LENS Bender Wirth: 634c Hekla</p>		
<p>LUMILEDS</p> <p>LED LUXEON Fusion 21-up (20x24)</p> <p>FWHM / FWTM 40.0° / 73.0°</p> <p>Efficiency 81 %</p> <p>Peak intensity 1.6 cd/m</p> <p>LEDs/each optic 21</p> <p>Light colour White</p> <p>Required components: C16142_HEKLA-SOCKET-K C14658_BARBARA-RZ-LENS Bender Wirth: 442 Typ L8</p>		
<p>PHILIPS</p> <p>LED Fortimo SLM L09 CoB</p> <p>FWHM / FWTM 42.0° / 74.0°</p> <p>Efficiency 91 %</p> <p>Peak intensity 1.6 cd/m</p> <p>LEDs/each optic 1</p> <p>Light colour White</p> <p>Required components: F15858_HEKLA-SOCKET-H</p>		
<p>PHILIPS</p> <p>LED Fortimo SLM L09 CoB</p> <p>FWHM / FWTM 41.0° / 74.0°</p> <p>Efficiency 87 %</p> <p>Peak intensity 1.6 cd/m</p> <p>LEDs/each optic 1</p> <p>Light colour White</p> <p>Required components: F15858_HEKLA-SOCKET-H C14658_BARBARA-RZ-LENS</p>		

OPTICAL RESULTS (MEASURED):

PHILIPS

LED Fortimo SLM L13 CoB
 FWHM / FWTM 40.0° / 72.0°
 Efficiency 88 %
 Peak intensity 1.7 cd/lm
 LEDs/each optic 1
 Light colour White
 Required components:
 C16142_HEKLA-SOCKET-K
 Bender Wirth: 432 Typ L8

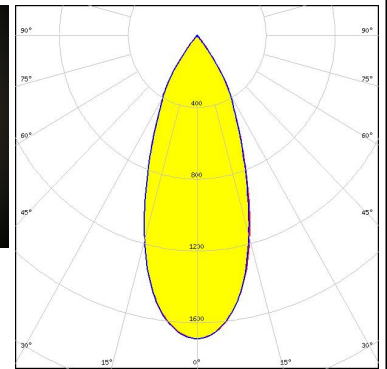

PHILIPS

LED Fortimo SLM L13 CoB
 FWHM / FWTM 41.0° / 74.0°
 Efficiency 83 %
 Peak intensity 1.5 cd/lm
 LEDs/each optic 1
 Light colour White
 Required components:
 C16142_HEKLA-SOCKET-K
 C14658_BARBARA-RZ-LENS
 Bender Wirth: 432 Typ L8

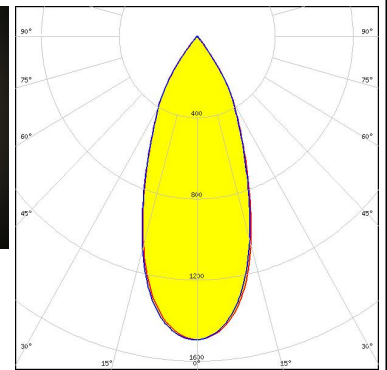

PHILIPS

LED Fortimo SLM L15 CoB
 FWHM / FWTM 43.0° / 75.0°
 Efficiency 82 %
 Peak intensity 1.4 cd/lm
 LEDs/each optic 1
 Light colour White
 Required components:
 C16142_HEKLA-SOCKET-K
 C14658_BARBARA-RZ-LENS
 Bender Wirth: 432 Typ L8

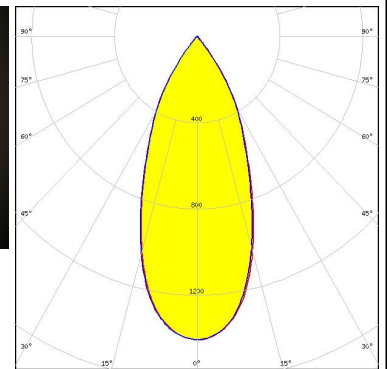
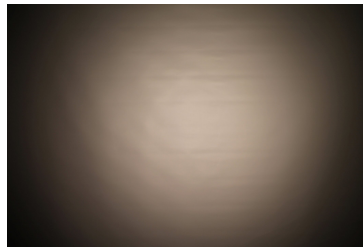

PHILIPS

LED Fortimo SLM L15 CoB
 FWHM / FWTM 42.0° / 73.0°
 Efficiency 88 %
 Peak intensity 1.6 cd/lm
 LEDs/each optic 1
 Light colour White
 Required components:
 C16142_HEKLA-SOCKET-K
 Bender Wirth: 432 Typ L8

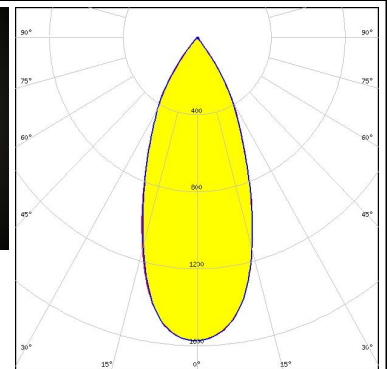
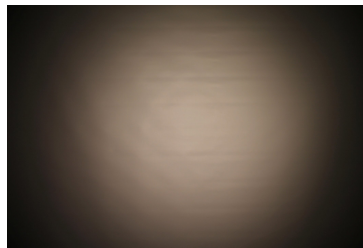

OPTICAL RESULTS (MEASURED):

SAMSUNG

LED LC003D / LC006D / LC009D / LC013D
 FWHM / FWTM 41.0° / 74.0°
 Efficiency 89 %
 Peak intensity 1.6 cd/m
 LEDs/each optic 1
 Light colour White
 Required components:
 F15255_HEKLA-SOCKET-C

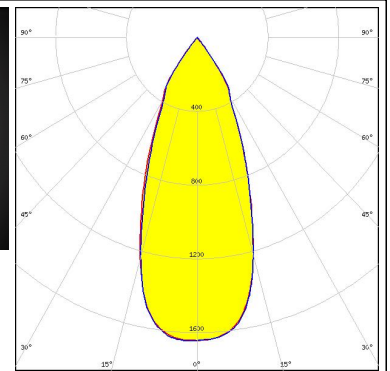
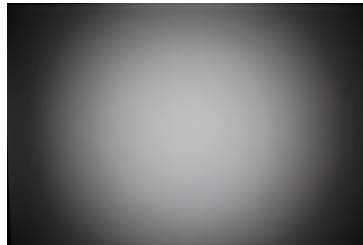

SAMSUNG

LED LC003D / LC006D / LC009D / LC013D
 FWHM / FWTM 41.0° / 74.0°
 Efficiency 89 %
 Peak intensity 1.6 cd/m
 LEDs/each optic 1
 Light colour White
 Required components:
 F15255_HEKLA-SOCKET-C

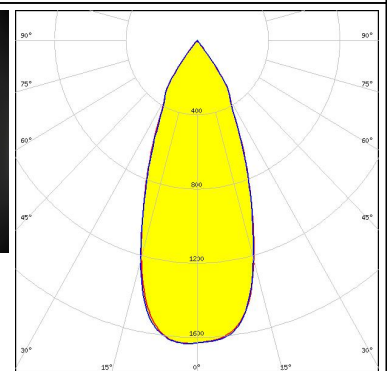
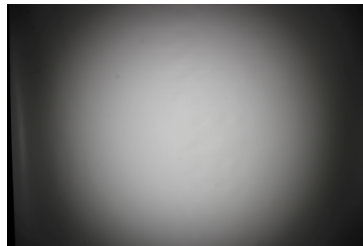

SAMSUNG

LED LC010C G2
 FWHM / FWTM 42.0° / 73.0°
 Efficiency 89 %
 Peak intensity 1.6 cd/m
 LEDs/each optic 1
 Light colour White
 Required components:
 F15255_HEKLA-SOCKET-C

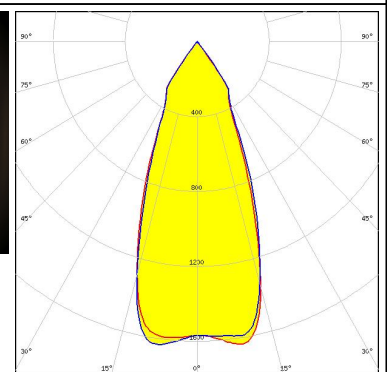
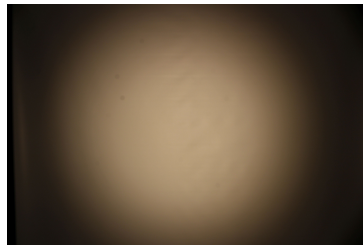

SAMSUNG

LED LC020T (Tunable white)
 FWHM / FWTM 39.0° / 72.0°
 Efficiency 85 %
 Peak intensity 1.7 cd/m
 LEDs/each optic 1
 Light colour Tunable White
 Required components:
 C16142_HEKLA-SOCKET-K
 Bender Wirth: 501 Typ L8

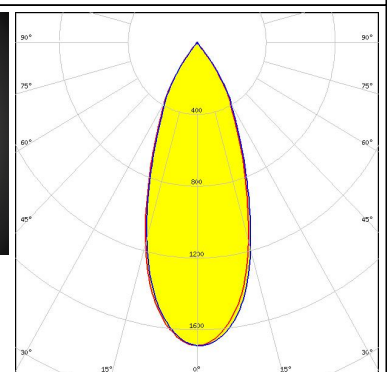
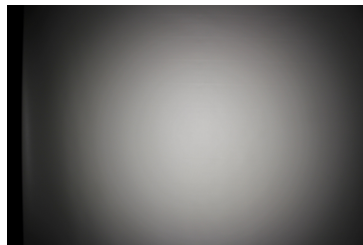

OPTICAL RESULTS (MEASURED):

SAMSUNG

LED LC020T (Tunable white)
 FWHM / FWTM 41.0° / 74.0°
 Efficiency 80 %
 Peak intensity 1.4 cd/lm
 LEDs/each optic 1
 Light colour Tunable White
 Required components:
 C16142_HEKLA-SOCKET-K
 C14658_BARBARA-RZ-LENS
 Bender Wirth: 501 Typ L8

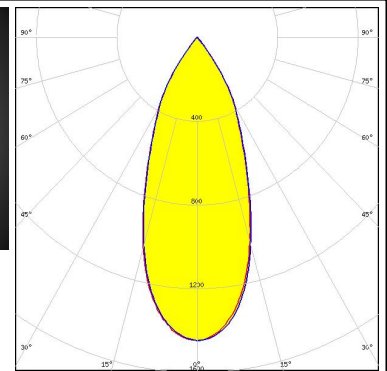
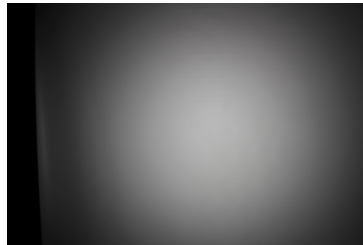

TRIDONIC

LED SLE G7 LES09
 FWHM / FWTM 41.0° / 73.0°
 Efficiency 92 %
 Peak intensity 1.7 cd/lm
 LEDs/each optic 1
 Light colour White
 Required components:
 F15255_HEKLA-SOCKET-C

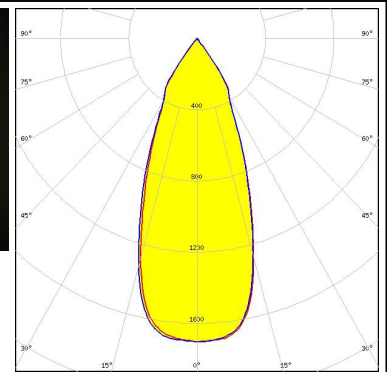
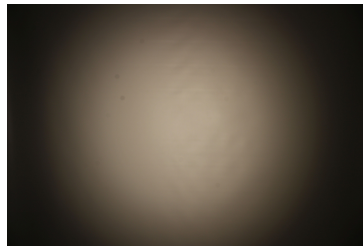

TRIDONIC

LED SLE G7 LES09
 FWHM / FWTM 41.0° / 73.0°
 Efficiency 87 %
 Peak intensity 1.6 cd/lm
 LEDs/each optic 1
 Light colour White
 Required components:
 F15255_HEKLA-SOCKET-C
 C14658_BARBARA-RZ-LENS

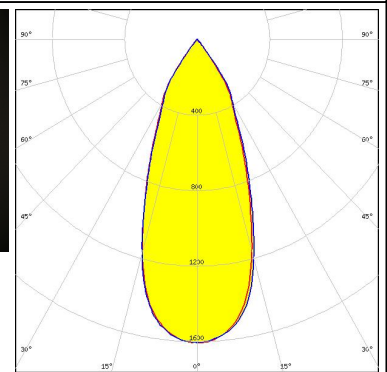
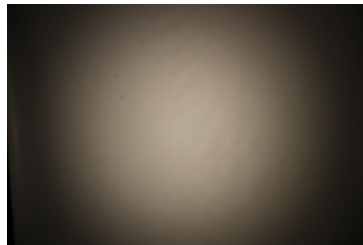

TRIDONIC

LED SLE G7 LES13
 FWHM / FWTM 40.0° / 73.0°
 Efficiency 88 %
 Peak intensity 1.7 cd/lm
 LEDs/each optic 1
 Light colour White
 Required components:
 F15859_HEKLA-SOCKET-I

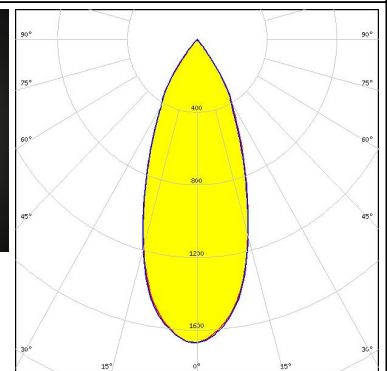
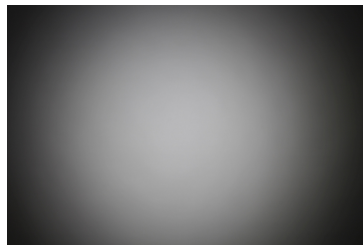

OPTICAL RESULTS (MEASURED):

TRIDONIC

LED SLE G7 LES13
 FWHM / FWTM 41.0° / 74.0°
 Efficiency 82 %
 Peak intensity 1.5 cd/lm
 LEDs/each optic 1
 Light colour White
 Required components:
 F15859_HEKLA-SOCKET-I
 C14658_BARBARA-RZ-LENS

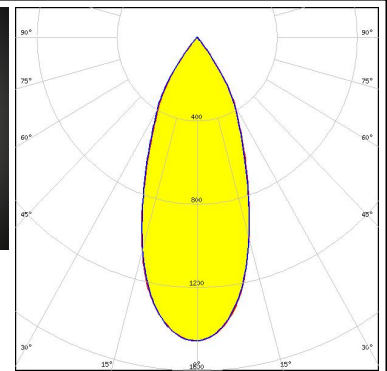
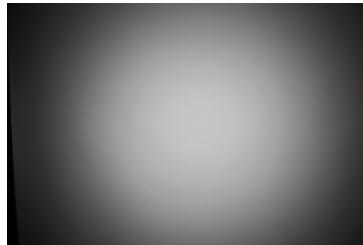

TRIDONIC

LED SLE G7 LES15
 FWHM / FWTM 41.0° / 74.0°
 Efficiency 88 %
 Peak intensity 1.6 cd/lm
 LEDs/each optic 1
 Light colour White
 Required components:
 F15859_HEKLA-SOCKET-I

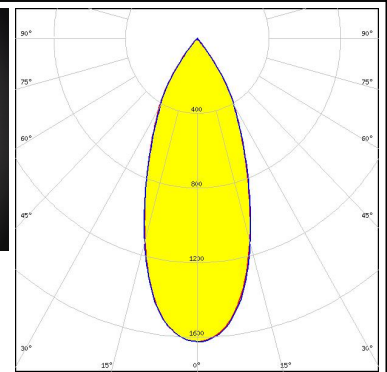
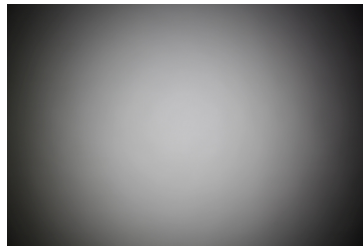

XICATO

LED XOB 14.5 mm
 FWHM / FWTM 41.0° / 74.0°
 Efficiency 89 %
 Peak intensity 1.6 cd/lm
 LEDs/each optic 1
 Light colour White
 Required components:
 F15859_HEKLA-SOCKET-I

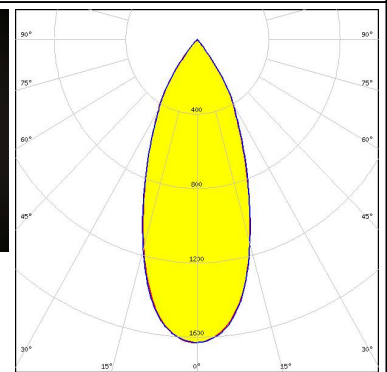
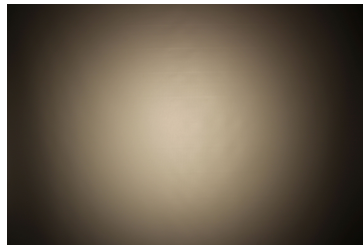

XICATO

LED XOB 6 mm
 FWHM / FWTM 42.0° / 74.0°
 Efficiency 88 %
 Peak intensity 1.6 cd/lm
 LEDs/each optic 1
 Light colour White
 Required components:
 F15255_HEKLA-SOCKET-C

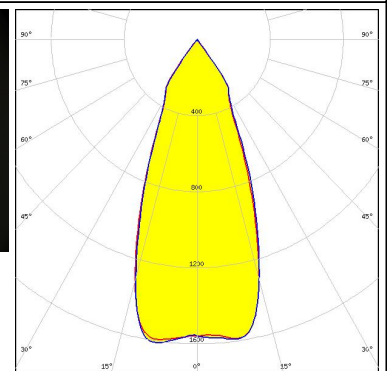
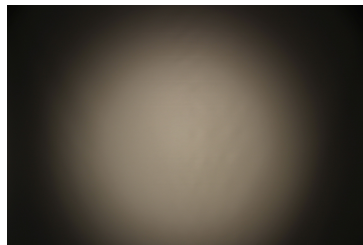

OPTICAL RESULTS (MEASURED):

XICATO

LED XOB 6 mm
 FWHM / FWTM 41.0° / 74.0°
 Efficiency 83 %
 Peak intensity 1.5 cd/lm
 LEDs/each optic 1
 Light colour White
 Required components:
 F15255_HEKLA-SOCKET-C
 C14658_BARBARA-RZ-LENS

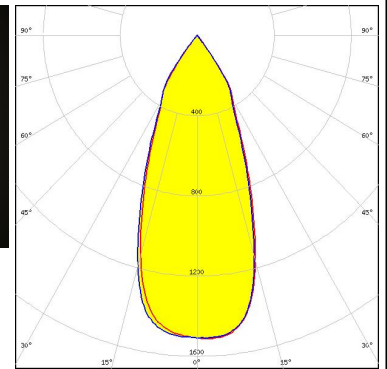

XICATO

LED XOB 9.8 mm
 FWHM / FWTM 42.0° / 74.0°
 Efficiency 89 %
 Peak intensity 1.6 cd/lm
 LEDs/each optic 1
 Light colour White
 Required components:
 F15255_HEKLA-SOCKET-C

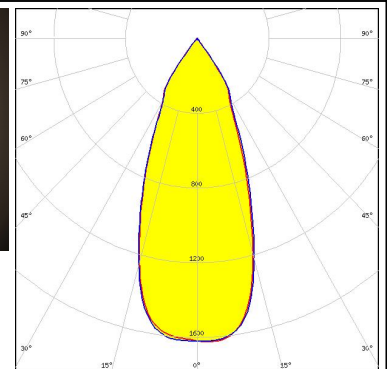
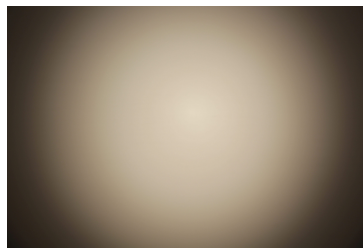





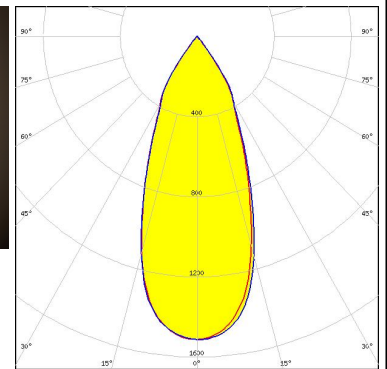
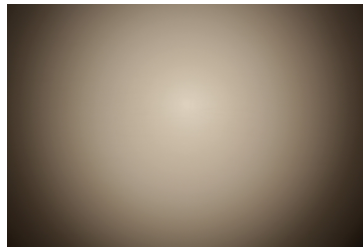

XICATO

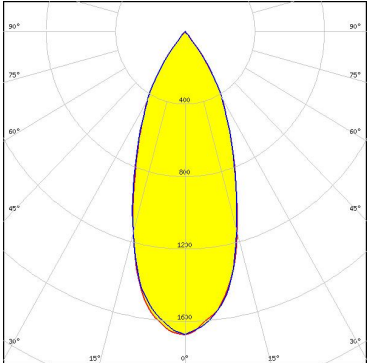
LED XOB 9.8 mm
 FWHM / FWTM 41.0° / 74.0°
 Efficiency 84 %
 Peak intensity 1.5 cd/lm
 LEDs/each optic 1
 Light colour White
 Required components:
 F15255_HEKLA-SOCKET-C
 C14658_BARBARA-RZ-LENS

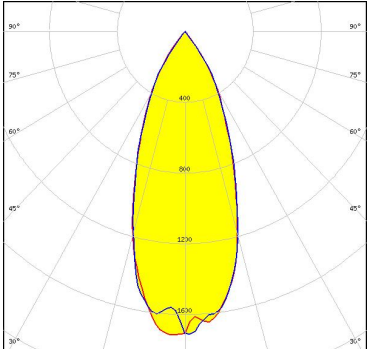

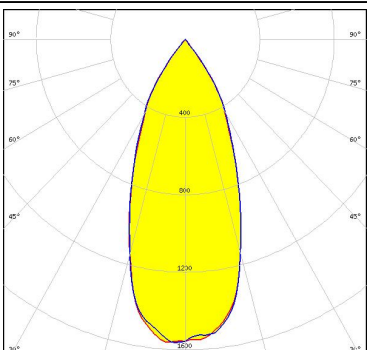
OPTICAL RESULTS (SIMULATED):

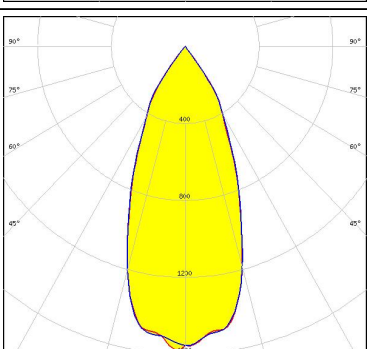
<p> bridgelux</p> <p>LED V13 Gen 8 FWHM / FWTM 40.0° / 74.0° Efficiency 89 % Peak intensity 1.7 cd/lm LEDs/each optic 1 Light colour White Required components: F17438_HEKLA-G2-I</p>	
<p> bridgelux</p> <p>LED Vesta DTW 15mm (33W) FWHM / FWTM 40.0° / 72.0° Efficiency 88 % Peak intensity 1.7 cd/lm LEDs/each optic 1 Light colour White Required components: C16142_HEKLA-SOCKET-K Bender Wirth: 491 Typ L8</p>	
<p> NICHIA</p> <p>LED COB L-Type (LES 11) FWHM / FWTM 42.0° / 75.0° Efficiency 90 % Peak intensity 1.6 cd/lm LEDs/each optic 1 Light colour White Required components: F15858_HEKLA-SOCKET-H</p>	
<p> NICHIA</p> <p>LED COB L-Type (LES 9) FWHM / FWTM 43.0° / 74.0° Efficiency 90 % Peak intensity 1.6 cd/lm LEDs/each optic 1 Light colour White Required components: F15858_HEKLA-SOCKET-H</p>	

GENERAL INFORMATION:

NOTE: The typical beam angle will be changed by different color, chip size and chip position tolerance. The typical total beam angle is the full angle measured where the luminous intensity is half of the peak value.

Due to use of high power COB's with this product, special attention to proper thermal design is highly recommended. LEDiL has no liability for direct, indirect or consecutive damages arising from the LEDiL products being used outside of the recommended temperature range.

MATERIALS:

As part of our continuous research and improvement processes, and to ensure the best possible quality and availability of our products, LEDiL reserves the right to change material grades without notice.

PRODUCT DATA USER AGREEMENT AND DISCLAIMER:

The measured data in the provided downloadable LEDiL Product Datasheets and Mechanical 2D-Drawings is rounded and provided as reference for planning. LEDiL Oy's optical specifications have been verified by conducting performance testing of the products in accordance with the company's quality system. The reported data are averaged results of multiple measurements with typical variation. LEDiL Oy reserves the right to without prior notification make changes and improvements to its products.

LEDiL Oy assumes neither warranty, nor guarantee nor any other liability of any kind for the contents and correctness of the provided data. The provided data has been generated with highest diligence but the provided data may in reality not represent the complete possible variation range of all intrinsic parameters. Therefore, in certain cases a deviation from the provided data could occur.

LEDiL Oy reserves the right to undertake technical changes of its products without further notification which could lead to changes in the provided data. LEDiL Oy assumes no liability of any kind for the possible deviation from any provided data or any other damage resulting from the usage of the provided data.

The user agrees to this disclaimer and user agreement with the download or usage of the provided files.

LEDiL Oy

Joensuunkatu 13
FI-24240 SALO
Finland

LEDiL Inc.

228 West Page Street
Suite D
Sycamore IL 60178
USA

Ledil Optics Technology (Shenzhen) Co., Ltd.

405 , Block B
Casic Motor Building
Shenzhen 518057
P.R.CHINA

Local sales and technical support

[www.ledil.com/
where_to_buy](http://www.ledil.com/where_to_buy)

Shipping locations

Salo, Finland
Hong Kong, China

Distribution Partners

[www.ledil.com/
where_to_buy](http://www.ledil.com/where_to_buy)