

CGHV14500F

500 W, DC - 1800 MHz, GaN HEMT
for L-Band Radar Systems

Description

WolfSpeed's CGHV14500 is a gallium nitride (GaN) high electron mobility transistor (HEMT) designed specifically with high efficiency, high gain and wide bandwidth capabilities, which makes the CGHV14500 ideal for DC - 1.8 GHz L-Band radar amplifier applications. The transistor could be utilized for band specific applications ranging from 800 through 1600 MHz. The package options are ceramic/metal flange and pill package.

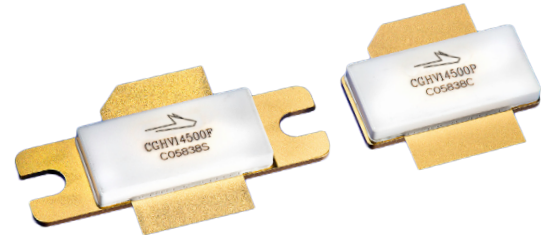

Package Types: 440117, 440133
PNs: CGHV14500F, CGHV14500P

Typical Performance Over 1.2 - 1.4 GHz ($T_c = 25^\circ\text{C}$) of Demonstration Amplifier

Parameter	1.2 GHz	1.25 GHz	1.3 GHz	1.35 GHz	1.4 GHz	Units
Outdoor Power	545	540	530	530	530	W
Gain	16.4	16.3	16.2	16.2	16.2	dB
Drain Efficiency	69	69	68	66	65	%

Note: Measured in the CGHV14500-AMP amplifier circuit, under 500 μs pulse width, 10% duty cycle, PIN = 41 dBm.

Features

- Reference design amplifier 1.2 - 1.4 GHz Operation
- FET tuning range UHF through 1800 MHz
- 500 W Typical Output Power
- 16 dB Power Gain
- 68% Typical Drain Efficiency
- <0.3 dB Pulsed Amplitude Droop
- Internally pre-matched on input, unmatched output



Large Signal Models Available for ADS and MWO





Absolute Maximum Ratings (not simultaneous)

Parameter	Symbol	Rating	Units	Conditions
Drain-Source Voltage	V_{DS}	150	V	25°C
Gate-to-Source Voltage	V_{GS}	-10, +2		
Storage Temperature	T_{STG}	-65, +150	°C	
Operating Junction Temperature	T_J	225		
Maximum Forward Gate Current	I_{GMAX}	84	mA	25°C
Maximum Drain Current ¹	I_{DMAX}	36	A	
Soldering Temperature ²	T_S	245	°C	
Screw Torque	τ	40	in-oz	
Pulsed Thermal Resistance, Junction to Case ³	$R_{\theta JC}$	0.28	°C/W	$P_{DISS} = 334 \text{ W}, 500 \mu\text{sec}, 10\%, 85^\circ\text{C}$
Pulsed Thermal Resistance, Junction to Case ⁴		0.31		
Case Operating Temperature ⁵	T_C	-40, +130	°C	$P_{DISS} = 334 \text{ W}, 500 \mu\text{sec}, 10\%$

Notes:

¹ Current limit for long term, reliable operation

² Refer to the Application Note on soldering at www.wolfspeed.com/rf/document-library

³ Measured for the CGHV14500P

⁴ Measured for the CGHV14500F

⁵ See also, the Power Dissipation De-rating Curve on Page 16

Electrical Characteristics ($T_C = 25^\circ\text{C}$)

Parameter	Symbol	Min.	Typ.	Max.	Units	Conditions
DC Characteristics¹						
Gate Threshold Voltage	$V_{GS(th)}$	-3.8	-3.0	-2.3	V_{DC}	$V_{DS} = 10 \text{ V}, I_D = 83.6 \text{ mA}$
Gate Quiescent Voltage	$V_{GS(Q)}$	—	-2.7	—		$V_{DS} = 50 \text{ V}, I_D = 500 \text{ mA}$
Saturated Drain Current ²	I_{DS}	54.3	77.7	—	A	$V_{DS} = 6.0 \text{ V}, V_{GS} = 2.0 \text{ V}$
Drain-Source Breakdown Voltage	V_{BR}	125	—	—	V_{DC}	$V_{GS} = -8 \text{ V}, I_D = 83.6 \text{ mA}$
RF Characteristics³ ($T_C = 25^\circ\text{C}$, $F_0 = 1.4 \text{ GHz}$ unless otherwise noted)						
Output Power	P_{OUT}	400	500	—	W	$V_{DD} = 50 \text{ V}, I_{DQ} = 500 \text{ mA}, P_{IN} = 41 \text{ dBm}$
Drain Efficiency	D_E	60	68	—	%	
Power Gain	G_P	15.25	16.2	—	dB	
Pulsed Amplitude Droop	D	—	-0.3	—		$V_{DD} = 50 \text{ V}, I_{DQ} = 500 \text{ mA}$
Output Mismatch Stress	VSWR	—	5 : 1	—	Y	No damage at all phase angles, $V_{DD} = 50 \text{ V}, I_{DQ} = 500 \text{ mA}, P_{IN} = 41 \text{ dBm}$ Pulsed
Dynamic Characteristics						
Input Capacitance	C_{GS}	—	295	—	pF	$V_{DS} = 50 \text{ V}, V_{GS} = -8 \text{ V}, f = 1 \text{ MHz}$
Output Capacitance	C_{DS}	—	27	—		
Feedback Capacitance	C_{GD}	—	2.7	—		

Notes:

¹ Measured on wafer prior to packaging

² Scaled from PCM data

³ Measured in CGHV14500-AMP. Pulsed Width = 500 μs , Duty Cycle = 10%.



Typical Performance of the CGHV14500F

Test conditions unless otherwise noted: $V_{DD} = 50\text{ V}$, $I_{DQ} = 500\text{ mA}$, $PW = 500\ \mu\text{s}$, $DC = 10\%$, $P_{IN} = 42\text{ dBm}$, $T_{BASE} = +25^\circ\text{C}$

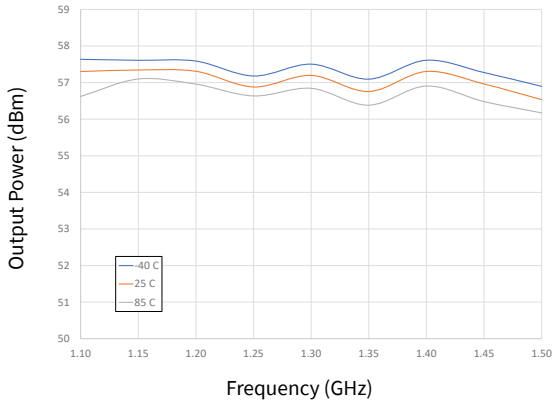

Figure 1. Output Power vs Frequency as a Function of Temperature

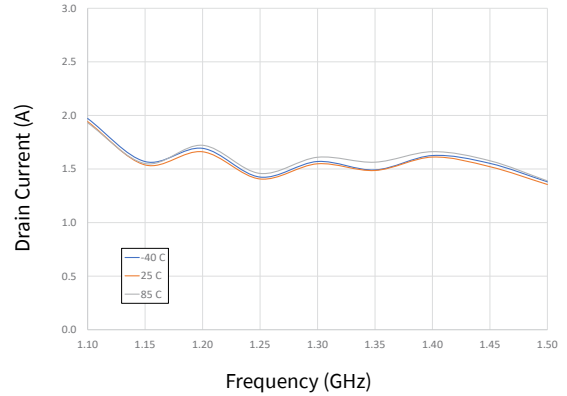

Figure 2. Drain Current vs Frequency as a Function of Temperature

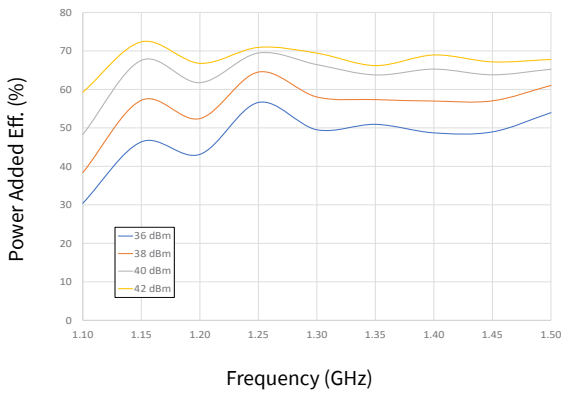

Figure 3. Power Added Eff. vs Frequency as a Function of Input Power

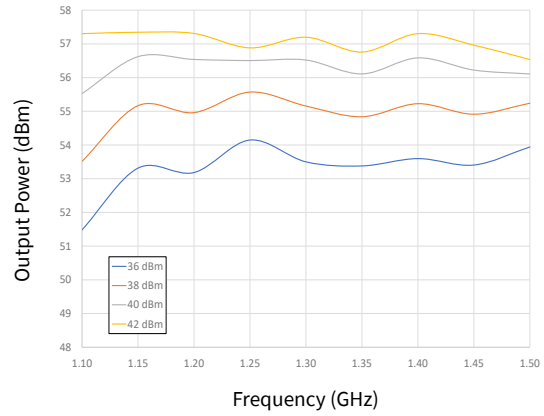

Figure 4. Output Power vs Frequency as a Function of Input Power

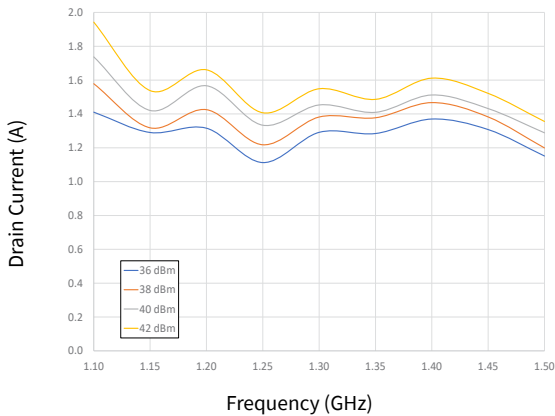

Figure 5. Drain Current vs Frequency as a Function of Input Power



Typical Performance of the CGHV14500F

Test conditions unless otherwise noted: $V_{DD} = 50\text{ V}$, $I_{DQ} = 500\text{ mA}$, $PW = 500\text{ }\mu\text{s}$, $DC = 10\%$, $P_{IN} = 42\text{ dBm}$, $T_{BASE} = +25^\circ\text{C}$

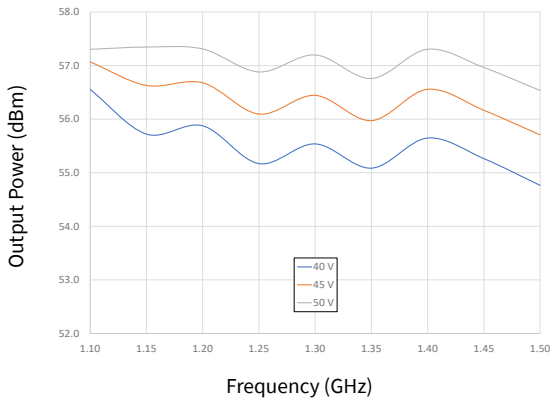

Figure 6. Output Power vs Frequency as a Function of Voltage

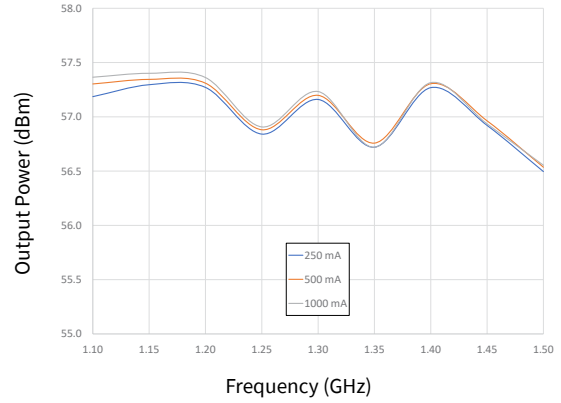

Figure 7. Output Power vs Frequency as a Function of I_{DQ}

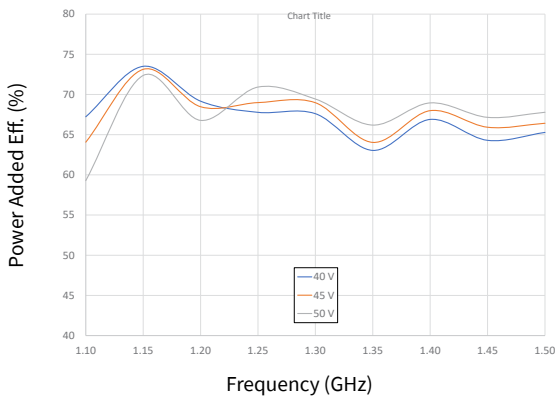

Figure 8. Power Added Eff. vs Frequency as a Function of Voltage

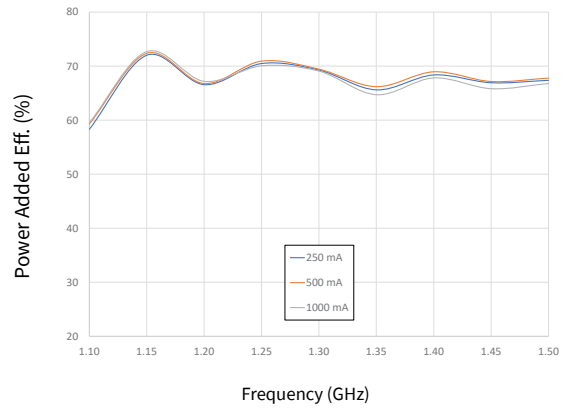

Figure 9. Power Added Eff. vs Frequency as a Function of I_{DQ}

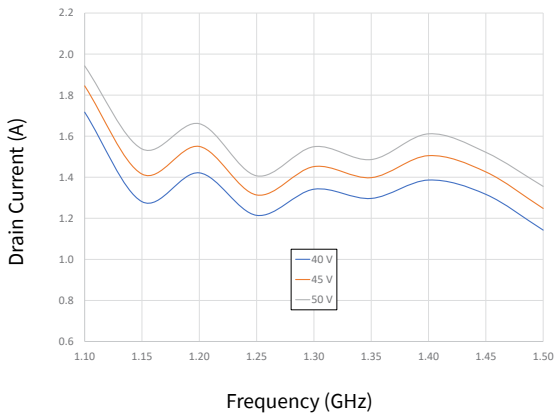

Figure 10. Drain Current vs Frequency as a Function of Voltage

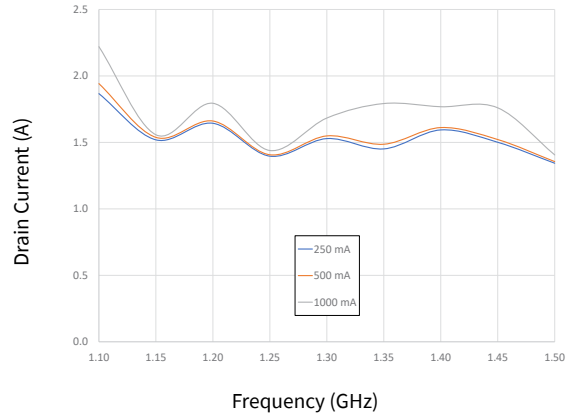

Figure 11. Drain Current vs Frequency as a Function of I_{DQ}



Typical Performance of the CGHV14500F

Test conditions unless otherwise noted: $V_{DD} = 50\text{ V}$, $I_{DQ} = 500\text{ mA}$, $PW = 500\text{ }\mu\text{s}$, $DC = 10\%$, $P_{IN} = 42\text{ dBm}$, $T_{BASE} = +25^\circ\text{C}$

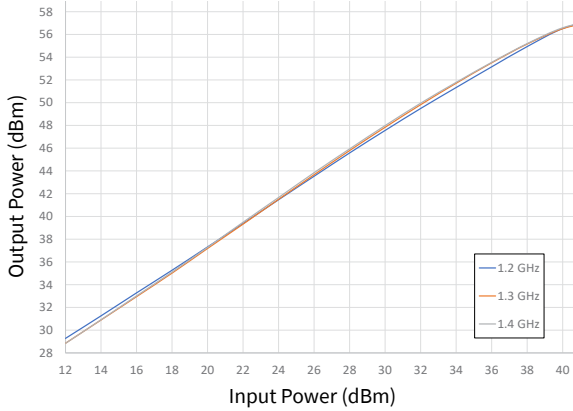

Figure 12. Output Power vs Input Power as a Function of Frequency

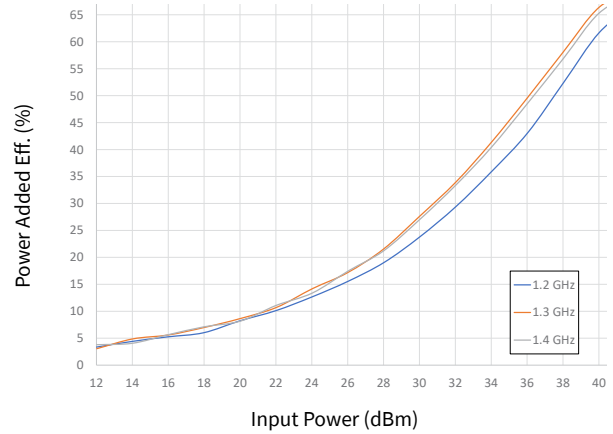

Figure 13. Power Added Eff. vs Input Power as a Function of Frequency

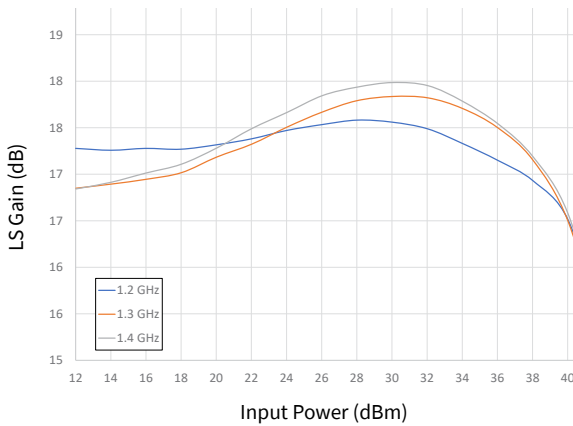

Figure 14. Large Signal Gain vs Input Power as a Function of Frequency

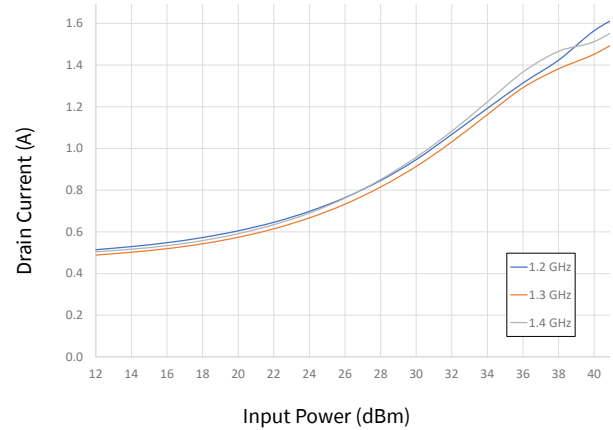

Figure 15. Drain Current vs Input Power as a Function of Frequency

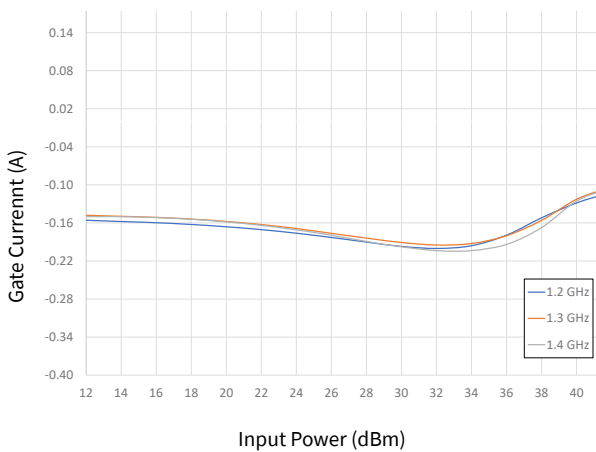

Figure 16. Gate Current vs Input Power as a Function of Frequency



Typical Performance of the CGHV14500F

Test conditions unless otherwise noted: $V_{DD} = 50\text{ V}$, $I_{DQ} = 500\text{ mA}$, $PW = 500\text{ }\mu\text{s}$, $DC = 10\%$, $P_{IN} = 42\text{ dBm}$, $T_{BASE} = +25\text{ }^\circ\text{C}$

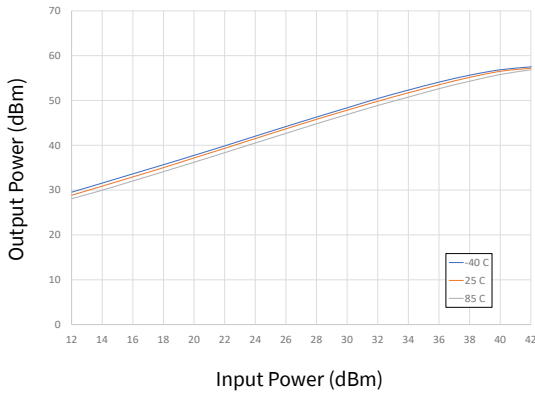

Figure 17. Output Power vs Input Power as a Function of Temperature

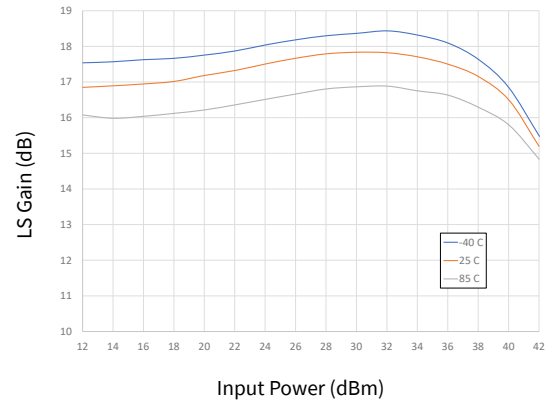

Figure 18. Large Signal Gain vs Input Power as a Function of Temperature

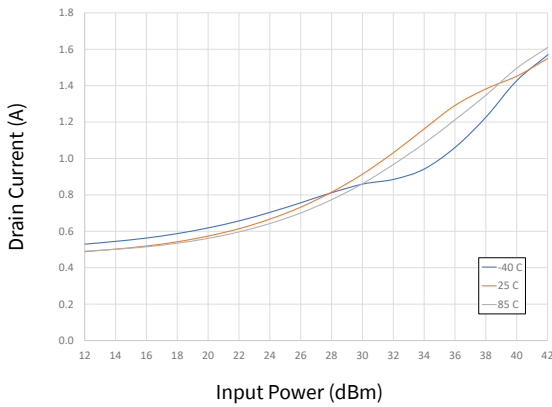

Figure 19. Drain Current vs Input Power as a Function of Temperature

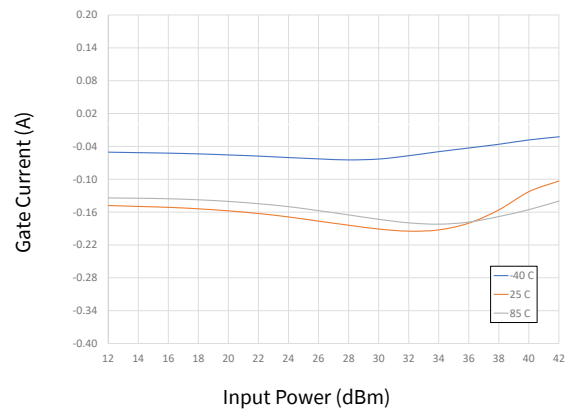

Figure 20. Gate Current vs Input Power as a Function of Temperature



Typical Performance of the CGHV14500F

Test conditions unless otherwise noted: $V_{DD} = 50\text{ V}$, $I_{DQ} = 500\text{ mA}$, $PW = 500\text{ }\mu\text{s}$, $DC = 10\%$, $P_{IN} = 42\text{ dBm}$, $T_{BASE} = +25^\circ\text{C}$

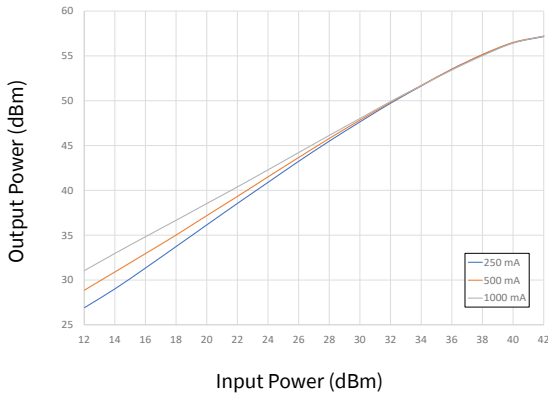

Figure 21. Output Power vs Input Power as a Function of I_{DQ}

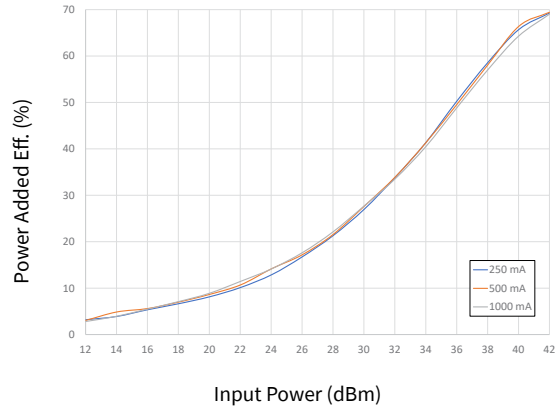

Figure 22. Power Added Eff. vs Input Power as a Function of I_{DQ}

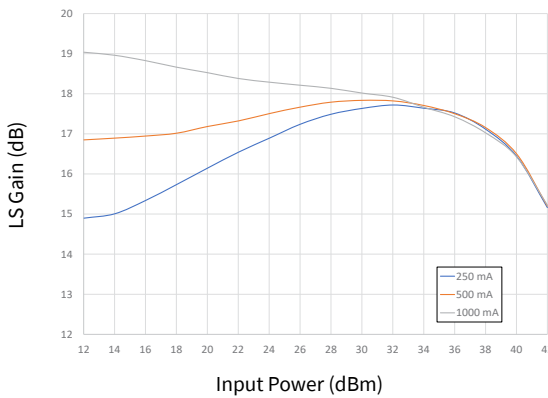

Figure 23. Large Signal Gain vs Input Power as a Function of I_{DQ}

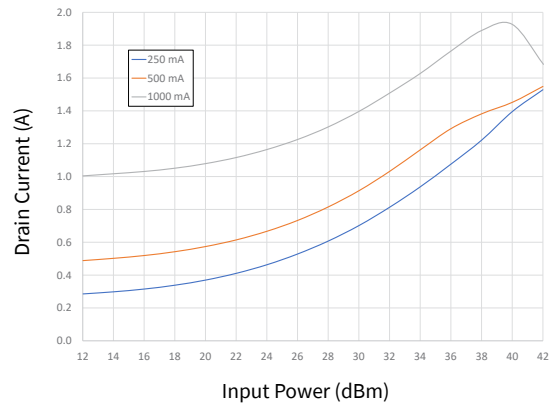

Figure 24. Drain Current vs Input Power as a Function of I_{DQ}

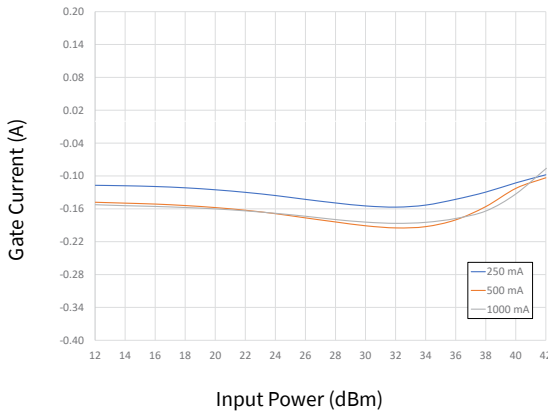

Figure 25. Gate Current vs Input Power as a Function of I_{DQ}



Typical Performance of the CGHV14500F

Test conditions unless otherwise noted: $V_{DD} = 50\text{ V}$, $I_{DQ} = 500\text{ mA}$, CW, $P_{IN} = -20\text{ dBm}$, $T_{BASE} = +25^\circ\text{C}$

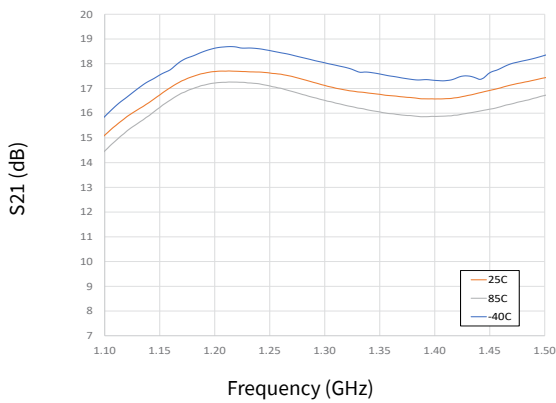

Figure 26. Gain vs Frequency as a Function of Temperature

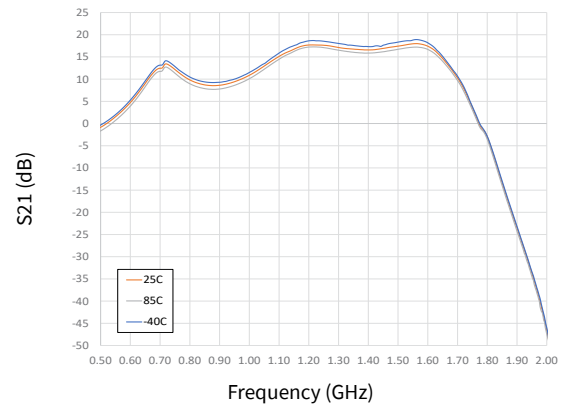

Figure 27. Gain vs Frequency as a Function of Temperature

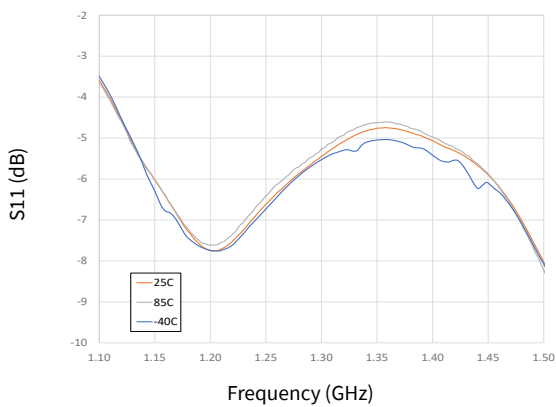

Figure 28. Input RL vs Frequency as a Function of Temperature

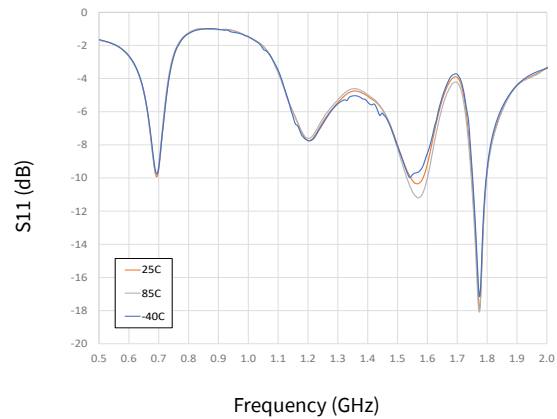

Figure 29. Input RL vs Frequency as a Function of Temperature

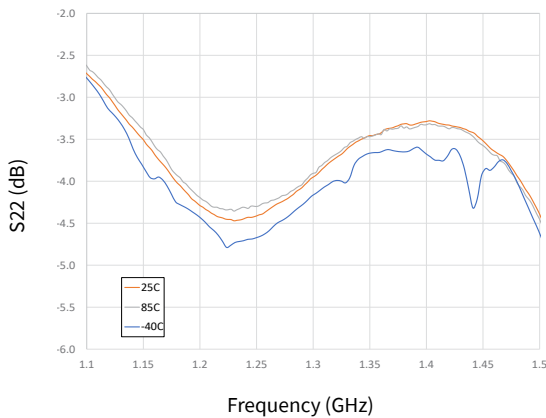

Figure 30. Output RL vs Frequency as a Function of Temperature

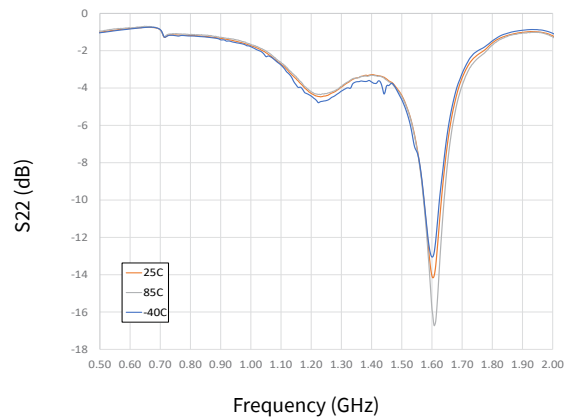

Figure 31. Output RL vs Frequency as a Function of Temperature



Typical Performance of the CGHV14500F

Test conditions unless otherwise noted: $V_{DD} = 50\text{ V}$, $I_{DQ} = 500\text{ mA}$, CW, $P_{IN} = -20\text{ dBm}$, $T_{BASE} = +25^\circ\text{C}$

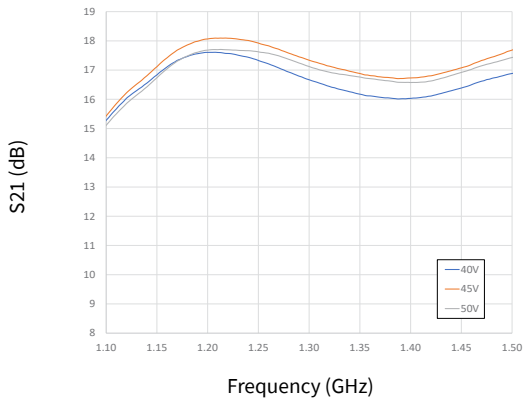

Figure 32. Gain vs Frequency as a Function of Voltage

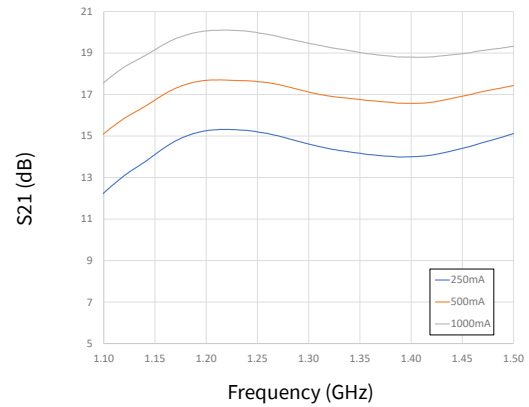

Figure 33. Gain vs Frequency as a Function of I_{DQ}

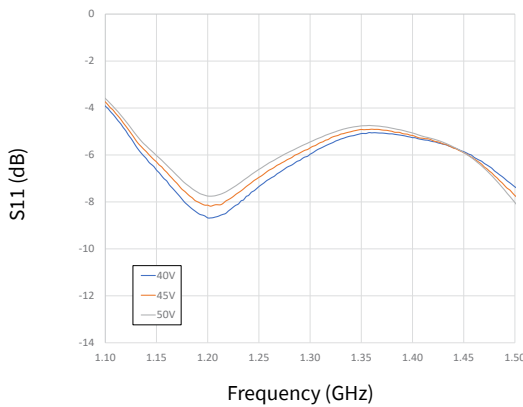

Figure 34. Input RL vs Frequency as a Function of Voltage

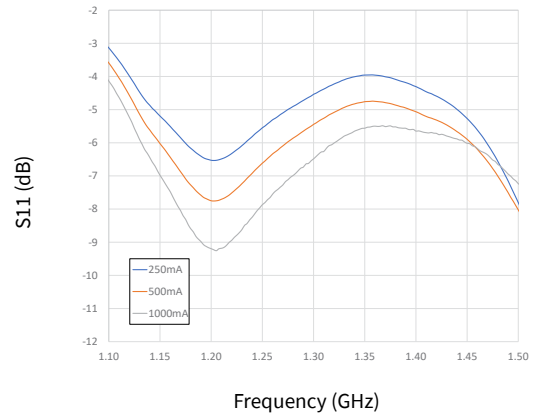

Figure 35. Input RL vs Frequency as a Function of I_{DQ}

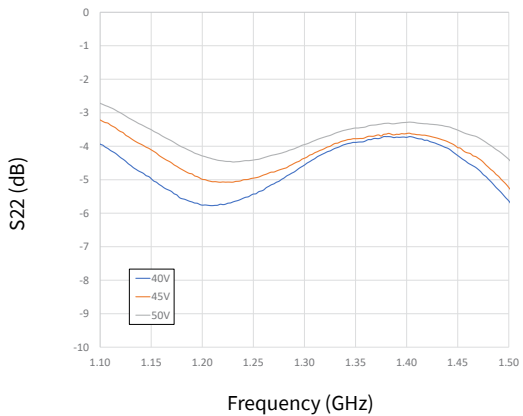

Figure 36. Output RL vs Frequency as a Function of Voltage

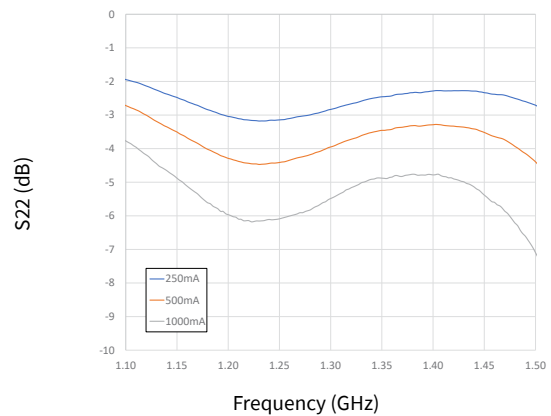

Figure 37. Output RL vs Frequency as a Function of I_{DQ}



CGHV14500F-AMP Demonstration Amplifier Circuit Bill of Materials

Designator	Description	Qty
R1	RES, 1/16W, 0603, 1%, 562 ohms	1
R2	RES, 5.1 ohm, +/-1%, 1/16W, 0603	1
R3	RES, 1/16W, 0603, 1%, 4700 ohms	1
L1	INDUCTOR, CHIP, 6.8 nH, 0603 SMT	1
C1, C23	CAP, 27pF, +/- 5%, 250V, 0805, ATC 600F	2
C2	CAP, 2.0pF, +/- 0.1pF, 0603, ATC	1
C3, C4	CAP, 1.5pF, +/-0.05pF, 250V, 0805, ATC 600F	2
C5,C6	CAP, 1.8pF, +/-0.1pF, 250V, 0805, ATC 600F	2
C7,C8	CAP, 4.3pF, +/-0.1pF, 250V, 0805, ATC 600F	2
C9,C10	CAP, 7.5pF, +/-0.1pF, 250V, 0805, ATC 600F	2
C11,C24	CAP, 47pF,+/-5%, 250V, 0805, ATC 600F	2
C12,C25	CAP, 100pF, +/-5%, 250V, 0805, ATC 600F	2
C13,C26	CAP, 33000pF, 0805, 100V, X7R	2
C14	CAP, 10μF, 16V, TANTALUM	1
C15,C16	CAP, 5.6pF, +/-0.1pF, 250V, 0805, ATC 600F	2
C17,C18	CAP, 3.6pF, +/-0.1pF, 250V, 0805, ATC 600F	2
C19,C20	CAP, 2.0pF, +/-0.1pF, 250V, 0805, ATC 600F	2
C21,C22	CAP, 0.7pF, +/-0.05pF, 0805, ATC 600F	2
C27	CAP, 1.0μF, 100V, 10%, X7R, 1210	1
C28	CAP, 3300 μF, +/-20%, 100V, ELECTROLYTIC	1
J1,J2	CONN, SMA, PANEL MOUNT JACK, FL	2
J3	HEADER RT>PLZ .1CEN LK 9POS	1
J4	CONNECTOR ; SMB, Straight, JACK, SMD	1
W1	CABLE, 18 AWG, 4.2	1
	PCB, RO4350B, 0.020' MIL THK, CGHV14500, 1.2-1.4GHZ	1
Q1	CGHV14500F	1

CGHV14500F-AMP Demonstration Amplifier Circuit

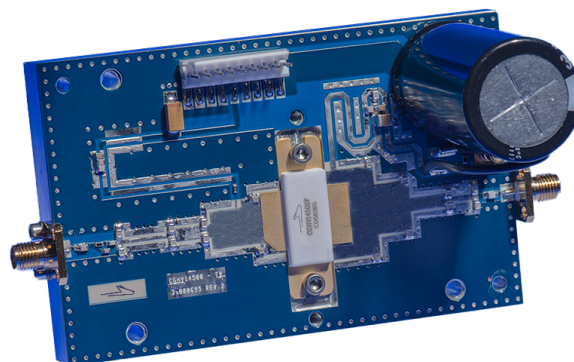



CGHV14500-AMP Demonstration Amplifier Circuit Outline

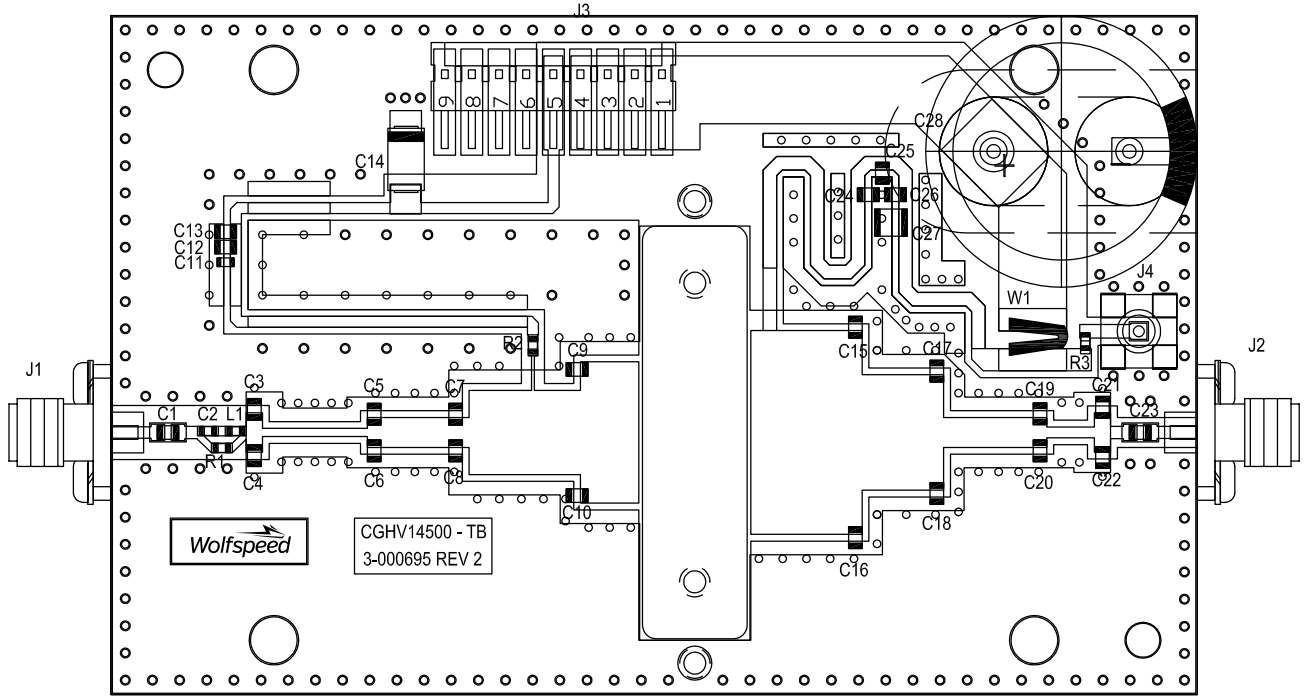

CGHV14500-AMP Demonstration Amplifier Circuit Schematic

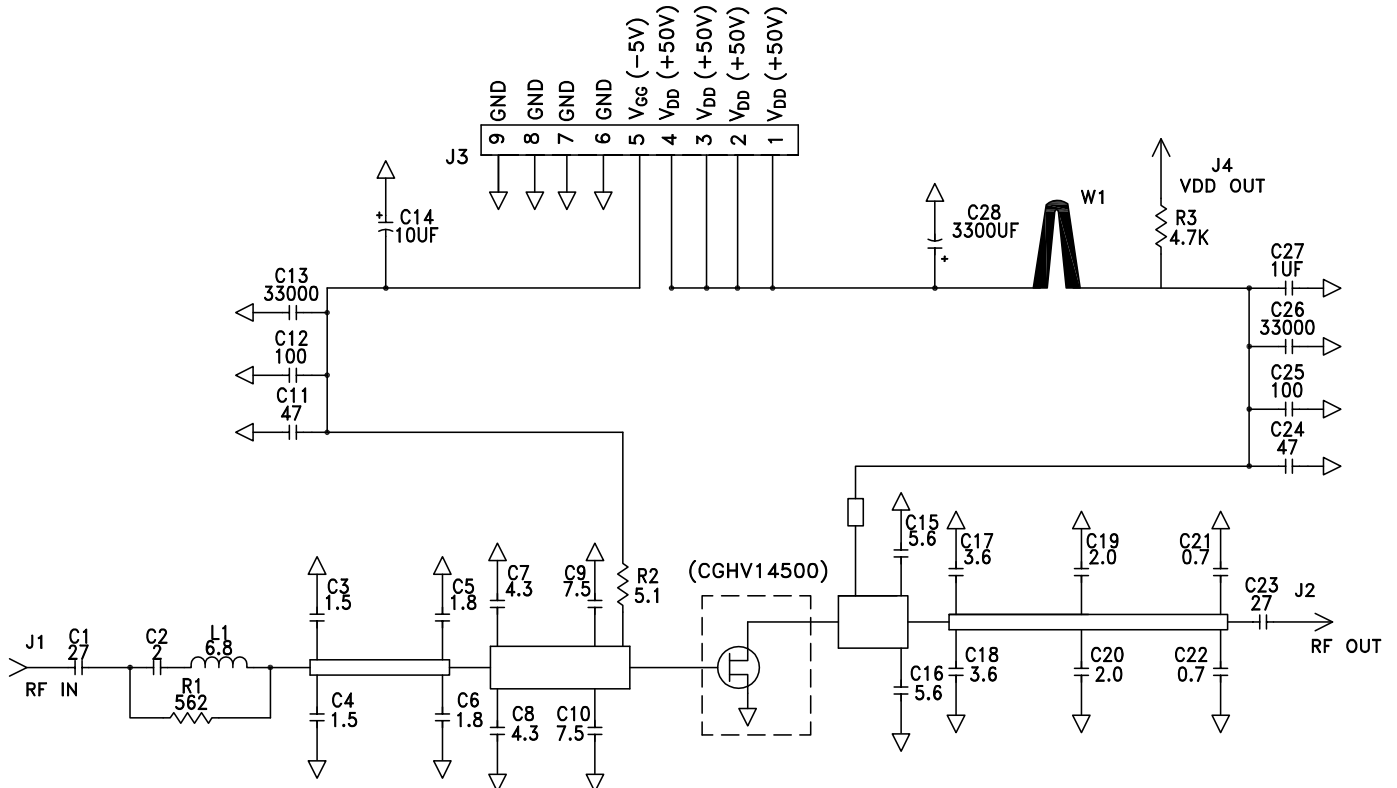



Typical Performance Over 0.96 GHz - 1.3 GHz ($T_c = 25^\circ\text{C}$) of Demonstration Amplifier

Parameter	0.96 GHz	1.0 GHz	1.1 GHz	1.2 GHz	1.3 GHz	Units
Outdoor Power	800	805	675	625	585	W
Gain	18	18.1	17.3	17.0	16.7	dB
Drain Efficiency	70	75	74	77	64	%

Note: Measured in the CGHV14500-AMP2 amplifier circuit, under 500 μs pulse width, 10% duty cycle, $P_{IN} = 41$ dBm.

Typical Performance - CGHV14500-AMP2

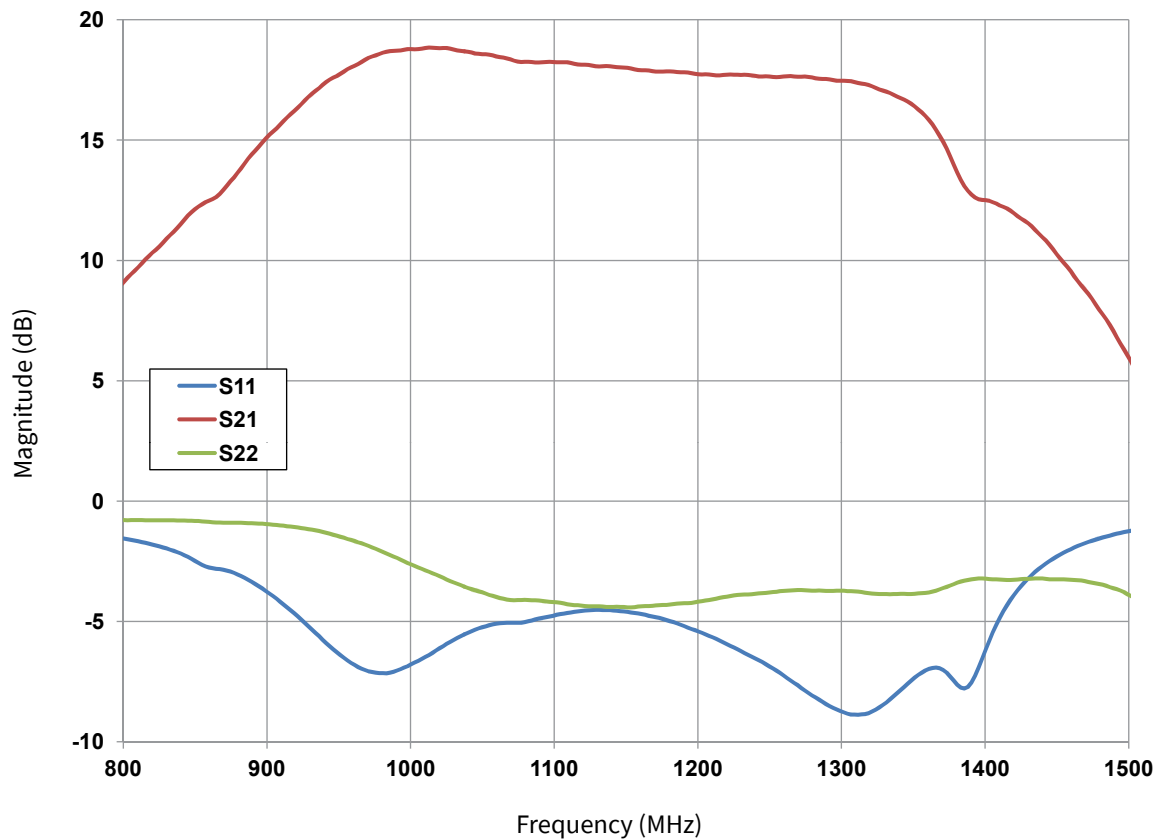

Figure 1. CGHV14500-AMP2 Typical S Parameters

$$V_{DD} = 50 \text{ V}, I_{DQ} = 500 \text{ mA}$$



Typical Performance - CGHV14500-AMP2

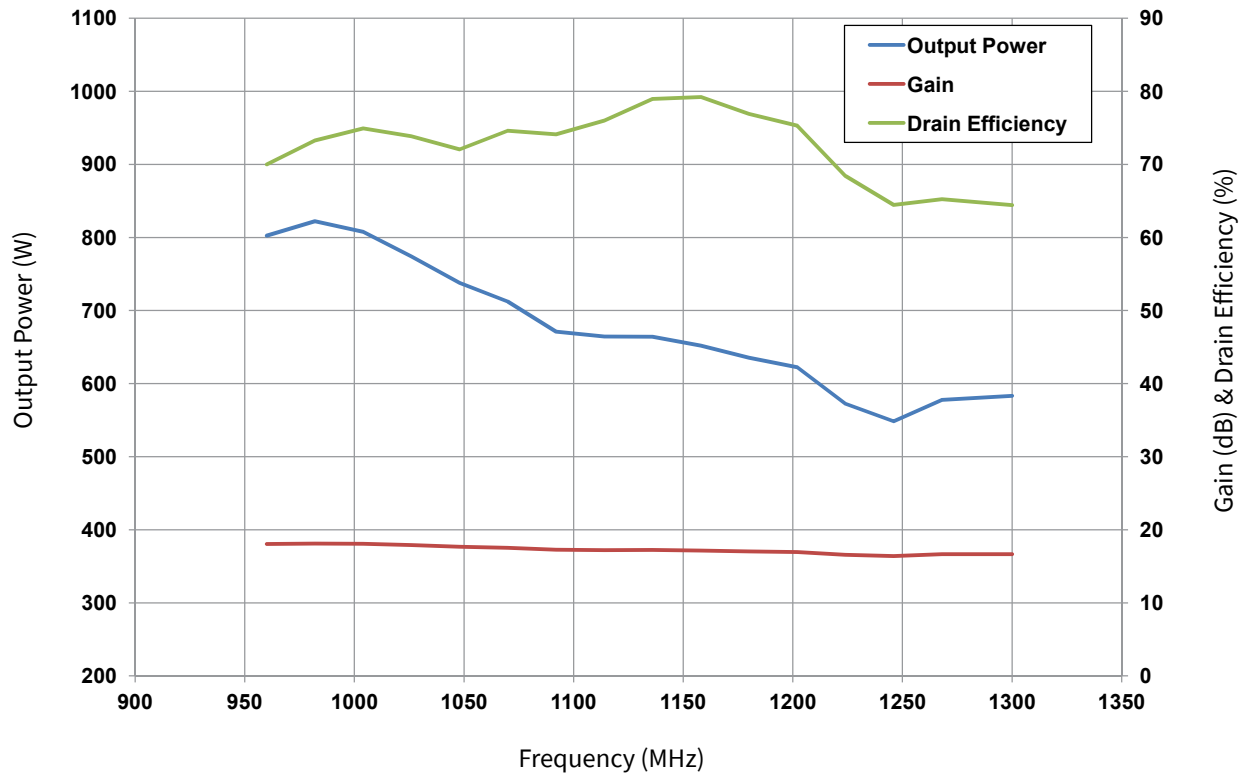

Figure 2. CGHV14500-AMP2 Typical S Parameters
 $V_{DD} = 50\text{ V}$, $I_{DQ} = 500\text{ mA}$, $P_{IN} = 41\text{ dBm}$, Pulse Width = $500\text{ }\mu\text{s}$, Duty Cycle 10%

Electrostatic Discharge (ESD) Classifications

Parameter	Symbol	Class	Classification Level	Test Methodology
Human Body Model	HBM	TBD	ANSI/ESDA/JEDEC JS-001 Table 3	JEDEC JESD22 A114-D
Charge Device Model	CDM	TBD	ANSI/ESDA/JEDEC JS-002 Table 3	JEDEC JESD22 C101-C



CGHV14500F-AMP Demonstration Amplifier Circuit Bill of Materials

Designator	Description	Qty
R1	RES,1/16W, 0603,1%, 562 ohms	1
R2	RES, 5.1 ohm, +/- 1%, 1/16W,0603	1
R3	RES, 1/16W, 0603,1%, 4.99K ohms	1
C1, C7, C8, C23	CAP, 10pF, +/-0.1pF, 250V, 0805, ATC 600F	4
C2, C15, C16	CAP, 5.6pF, +/-0.1pF, 250V, 0805, ATC 600F	3
C3, C4, C5, C6	CAP, 2.2pF, +/-0.1pF, 250V, 0805, ATC 600F	4
C17, C18	CAP, 2.4pF, +/-0.1pF, 250V, 0805, ATC 600F	2
C19, C20	CAP, 2.0pF, +/-0.1pF, 250V, 0805, ATC 600F	2
C31, C32	CAP, 2.7pF, +/-0.1pF, 250V, 0805, ATC 600F	2
C22, C33	CAP, 1.5pF, +/-0.1pF, 250V, 0805, ATC 600F	2
C11, C24	CAP, 47 pF +/- 5%, 250V, 0805, ATC 600F	2
C12, C25	CAP, 100 pF +/- 5%, 250V, 0805, ATC 600F	2
C13, C26	CAP, 33000pF, 0805,100V, X7R	2
C14	CAP, 10μF, 16V, TANTALUM	1
C27	CAP, 1.0μF, 100V, 10%, X7R, 1210	1
C28	CAP, 3300 μF, +/-20%, 100V, ELECTROLYTIC	1
J1, J2	CONN, SMA, PANEL MOUNT JACK, FL	2
J3	HEADER RT>PLZ .1CEN LK 9POS	1
J4	CONNECTOR ; SMB, Straight, JACK, SMD	1
W1	CABLE, 18 AWG, 4.2	1
	PCB, RO4350B, 0.020" THK, CGHV14500-TB1	1
	BASEPLATE, AL, 4.00 X 2.50 X 0.49, ALTERNATE HOLE PATTERN	1

CGHV14500F-AMP2 Demonstration Amplifier Circuit

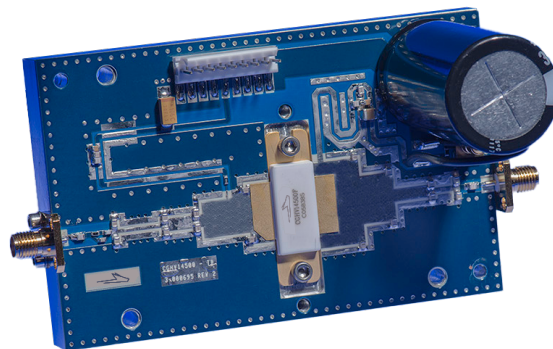



CGHV14500-AMP Demonstration Amplifier Circuit Outline

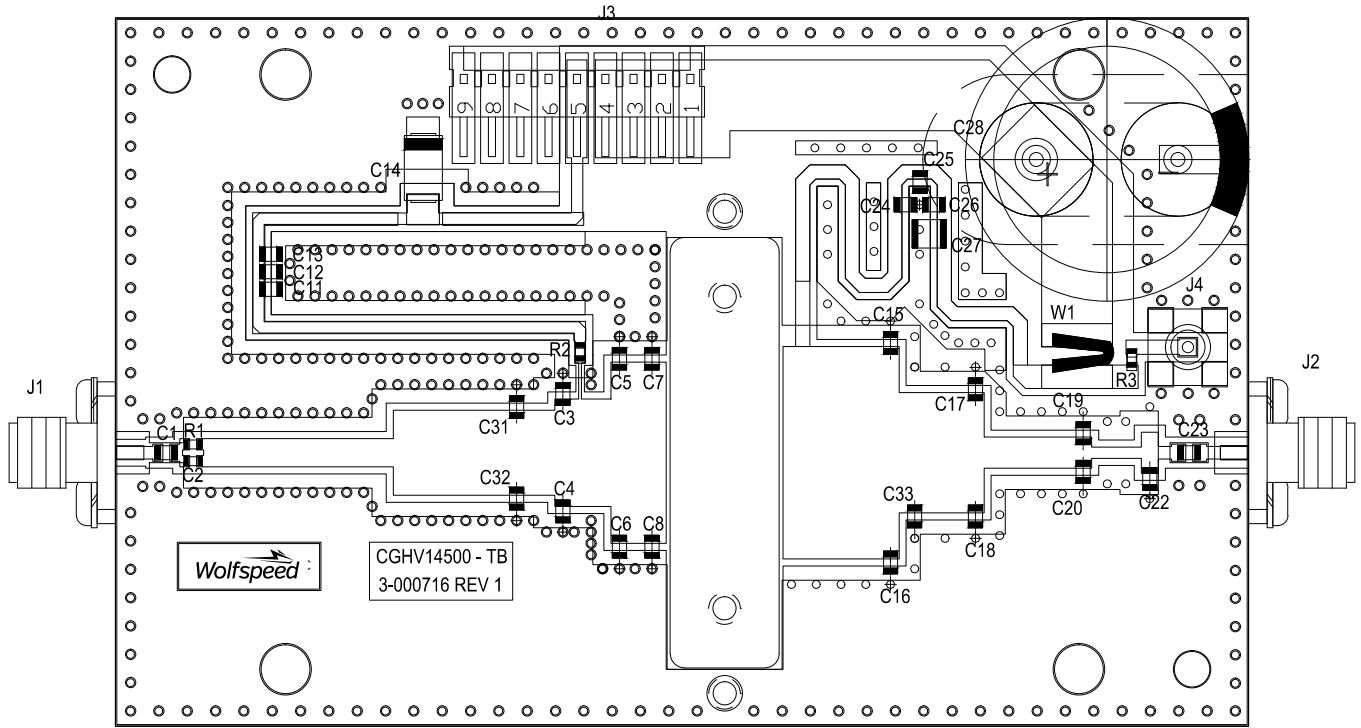

CGHV14500-AMP Demonstration Amplifier Circuit Schematic

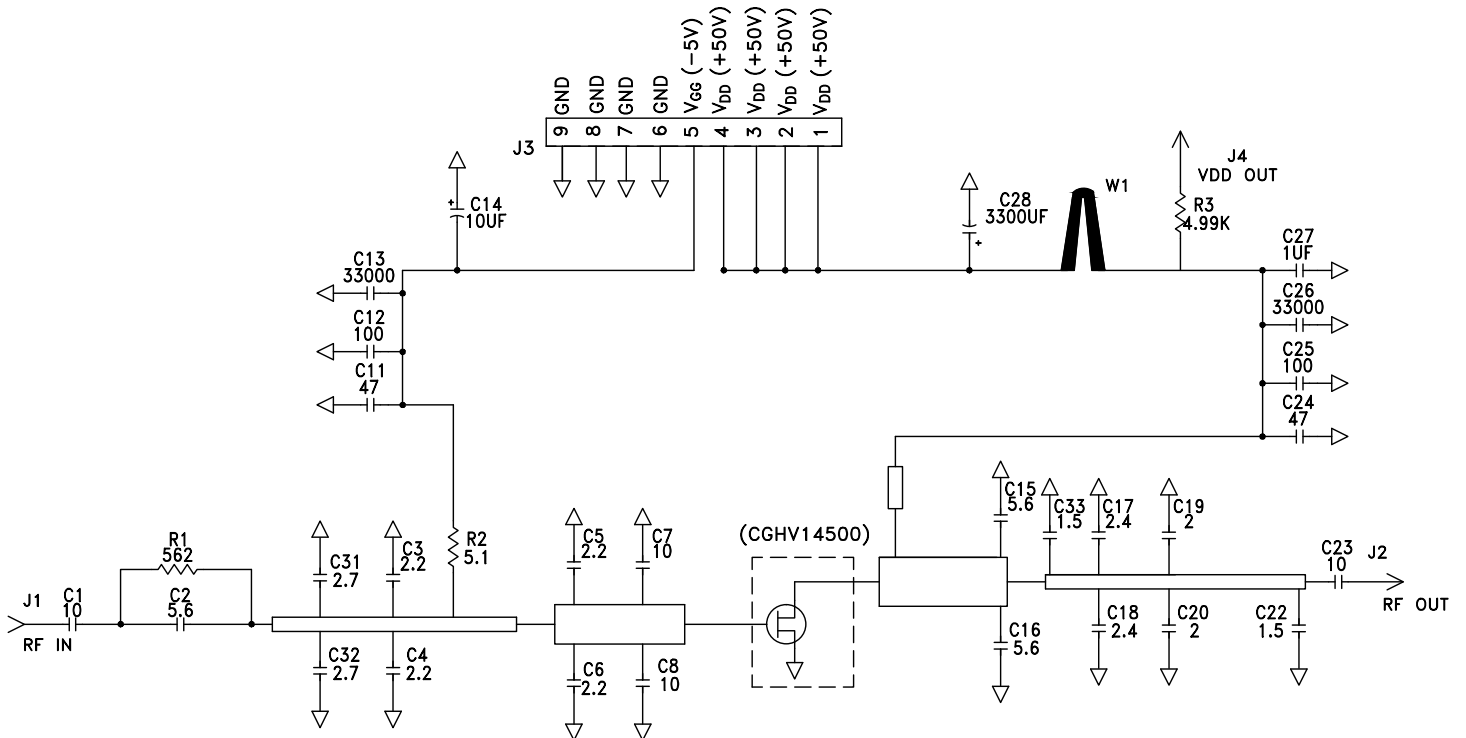



Source and Load Impedances

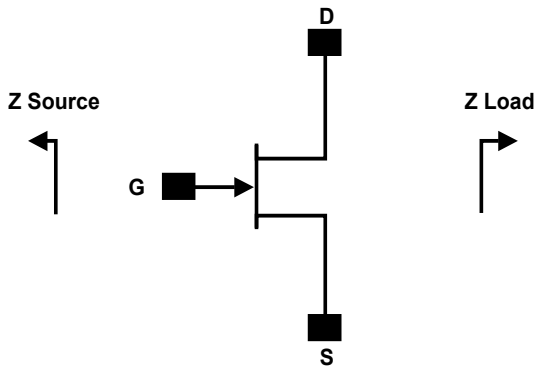

Frequency	Z Source	Z Load
900	0.3 - j0.3	2.1 + j1.4
1000	0.3 - j0.4	2.0 + j0.7
1100	0.6 - j0.4	1.8 + j0.9
1200	0.8 - j0.7	1.5 + j0.9
1300	1.1 - j0.7	1.3 + j0.7
1400	1.2 - j0.1	1.2 + j0.5
1500	1.8 - j0.1	1.1 + j0.4

- Notes:
- ¹ $V_{DD} = 50\text{ V}$, $I_{PO} = 500\text{ mA}$ in the 440117 package.
 - ² Optimized for power gain, P_{SAT} , and Drain Efficiency
 - ³ When using this device at low frequency, series resistors should be used to maintain amplifier stability.

CGHV14500 Power Dissipation De-rating Curve

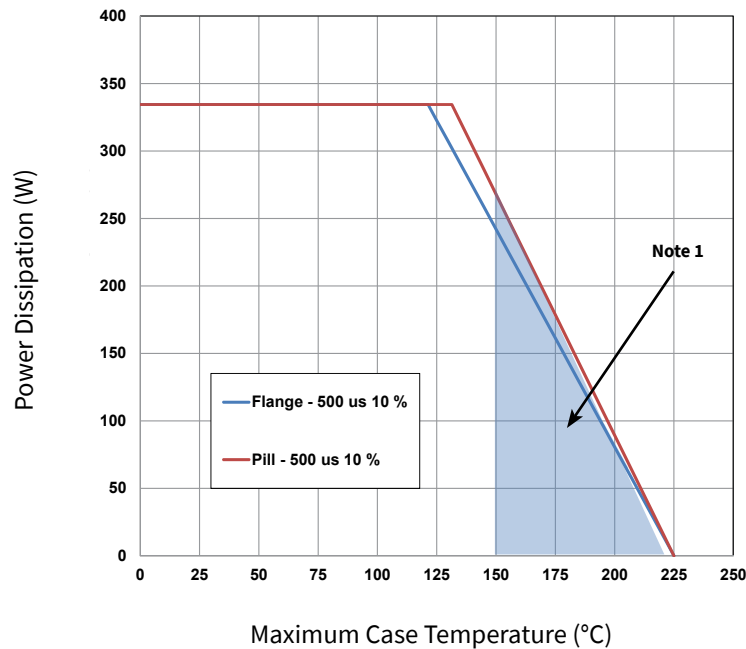

- Note:
- ¹ Area exceeds Maximum Case Operating Temperature (See Page 2)



Product Dimensions CGHV14500F (Package Type — 440117)

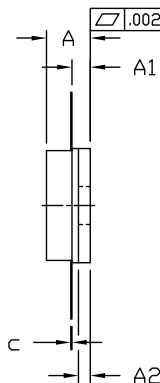
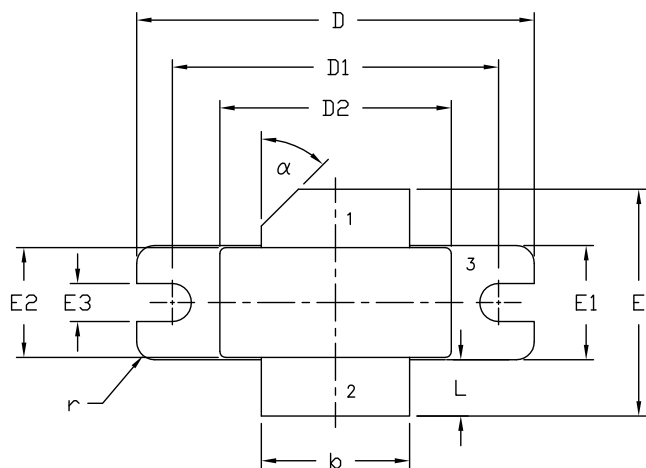

PIN 1. GATE
2. DRAIN
3. SOURCE

NOTES:

1. DIMENSIONING AND TOLERANCING PER ANSI Y14.5M - 1994.
2. CONTROLLING DIMENSION: INCH.
3. ADHESIVE FROM LID MAY EXTEND A MAXIMUM OF 0.020" BEYOND EDGE OF LID.
4. LID MAY BE MISALIGNED TO THE BODY OF PACKAGE BY A MAXIMUM OF 0.008" IN ANY DIRECTION.

DIM	INCHES		MILLIMETERS		NOTES
	MIN	MAX	MIN	MAX	
A	0.138	0.158	3.51	4.01	
A1	0.057	0.067	1.45	1.70	
A2	0.035	0.045	0.89	1.14	
b	0.495	0.505	12.57	12.83	2x
c	0.003	0.006	0.08	0.15	
D	1.335	1.345	33.91	34.16	
D1	1.095	1.105	27.81	28.07	
D2	0.773	0.787	19.63	20.00	
E	0.745	0.785	18.92	19.94	
E1	0.380	0.390	9.65	9.91	
E2	0.365	0.375	9.72	9.53	
E3	0.123	0.133	3.12	3.38	
L	0.170	0.210	4.32	5.33	2x
r	0.06 TYP		0.06 TYP		4x
α	45° REF		45° REF		

Product Dimensions CGHV14500P (Package Type — 440133)

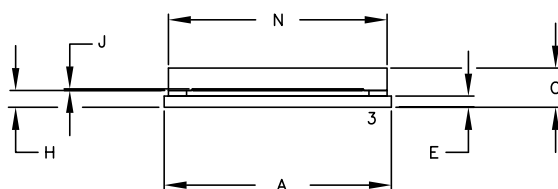
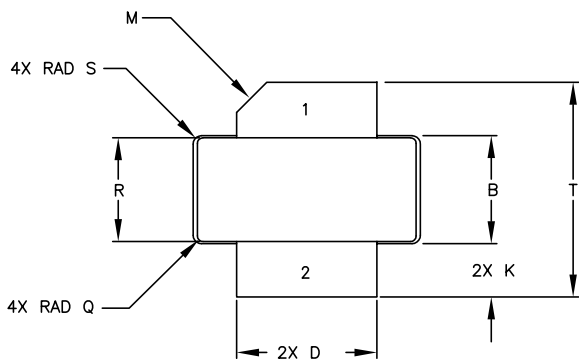

NOTES:

1. DIMENSIONING AND TOLERANCING PER ANSI Y14.5M, 1982.
2. CONTROLLING DIMENSION: INCH.
3. ADHESIVE FROM LID MAY EXTEND A MAXIMUM OF 0.020" BEYOND EDGE OF LID.
4. LID MAY BE MISALIGNED TO THE BODY OF PACKAGE BY A MAXIMUM OF 0.008" IN ANY DIRECTION.

DIM	INCHES		MILLIMETERS	
	MIN	MAX	MIN	MAX
A	0.805	0.815	20.45	20.70
B	0.380	0.390	9.65	9.91
C	0.135	0.149	3.43	3.78
D	0.495	0.505	12.57	12.83
E	0.035	0.045	.89	1.14
H	0.057	0.067	1.45	1.70
J	0.003	0.006	.08	.15
K	0.170	0.210	4.32	5.33
M	45° REF		45° REF	
N	0.773	0.787	19.63	19.99
Q	0.020 REF		0.51 REF	
R	0.364	0.374	9.25	9.50
S	0.030 REF		0.76 REF	
T	0.745	0.785	18.92	19.94

STYLE 1:
PIN 1. GATE
2. DRAIN
3. SOURCE



Part Number System

CGHV14500F

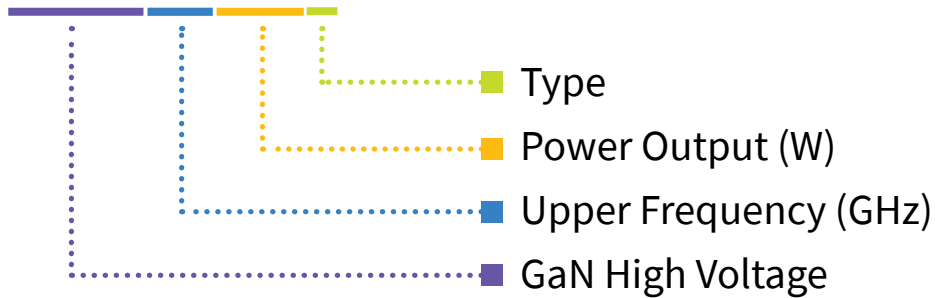

Table 1.

Parameter	Value	Units
Upper Frequency ¹	1.4	GHz
Power Output	250	W
Type	F = Flanged P = Package	—

Note:

¹ Alpha characters used in frequency code indicate a value greater than 9.9 GHz. See Table 2 for value.

Table 2.

Character Code	Code Value
A	0
B	1
C	2
D	3
E	4
F	5
G	6
H	7
J	8
K	9
Examples:	1A = 10.0 GHz 2H = 27.0 GHz

Product Ordering Information

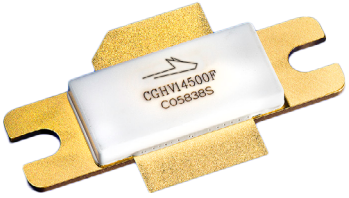
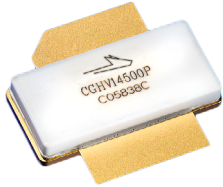
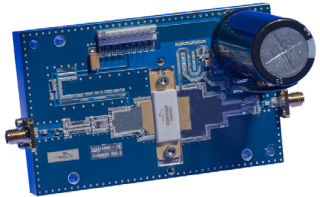
Order Number	Description	Unit of Measure	Image
CGHV14500F	GaN HEMT	Each	
CGHV14500P	GaN HEMT	Each	
CGHV14500F-AMP	Test board with GaN HEMT installed	Each	

**For more information, please contact:**

4600 Silicon Drive
Durham, NC 27703 USA
Tel: +1.919.313.5300
www.wolfspeed.com/RF

Sales Contact
RFSales@wolfspeed.com

RF Product Marketing Contact
RFMarketing@wolfspeed.com

Notes & Disclaimer

Specifications are subject to change without notice. “Typical” parameters are the average values expected by Wolfspeed in large quantities and are provided for information purposes only. Wolfspeed products are not warranted or authorized for use as critical components in medical, life-saving, or life-sustaining applications, or other applications where a failure would reasonably be expected to cause severe personal injury or death. No responsibility is assumed by Wolfspeed for any infringement of patents or other rights of third parties which may result from use of the information contained herein. No license is granted by implication or otherwise under any patent or patent rights of Wolfspeed.

© 2014-2022 Wolfspeed, Inc. All rights reserved. Wolfspeed® and the Wolfstreak logo are registered trademarks and the Wolfspeed logo is a trademark of Wolfspeed, Inc.
PATENT: <https://www.wolfspeed.com/legal/patents>

The information in this document is subject to change without notice.