



Mag Layers USA, INC

Specification Sheet

P/N : MSCDRI-127A-SERIES-RU

Products:

[Molded Power Chokes](#)

[Multilayer Chip Inductors](#)

[Lan Transformer](#)

[RF Passive / Antennas](#)

[Automotive](#)

Certifications:

[ISO9001](#)

[IATF16949](#)

[ISO14001](#)

[QC080000](#)

US Office

5406 Bolsa Ave.,
Huntington Beach, CA 92649
(714) 898-8377

Contact Us

www.maglayersusa.com
info@maglayersusa.com

REVISIONS

REV.	Description	Date	Approved by	Checked by	Checked by	Prepared by
00	Issue	2009.03.11	Alfa	Vivian	Marco	Sara



I . SCOPE :

This specification applies to the Pb Free high current type SMD inductors for
MSCDRI-127A-SERIES-RU

PRODUCT IDENTIFICATION

MSCDRI - 127A - 100 M - RU

① ② ③ ④ ⑤

- ① Product Code
- ② Dimensions Code
- ③ Inductance Code
- ④ Tolerance Code
- ⑤ Inner Control Code

II . INDEX :

LISTED ITEM	ATTACHEMENT & TABLES	PAGE
1. SHAPES AND DIMENSIONS	Please see (1)	2/9
2. MATERIALS	Please see (3)	2/9
3. ELECTRICAL SPECIFICATIONS	Please see (2)	2/9 · 3/9
4. CHARACTERISTICS	Please see (3)	2/9 · 3/9
5. RELIABILITY TEST METHOD	Please see (4)	4/9 · 5/9 · 6/9
6. LAND DIMENSION (Ref.)	Please see (5)	7/9
7. PACKAGING	Please see (6)	8/9 · 9/9
8. STANDARD TEST CONDITIONS		
Unless otherwise specified, test condition should be Temp. = 20±15℃, Humidity = 35~85%		
But if needed, then test condition should be Temp. = 20±2℃, Humidity = 65±5%		



(1) SHAPES AND DIMENSIONS

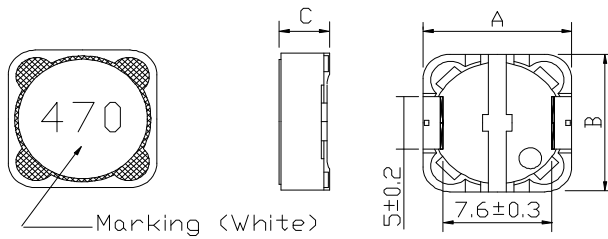

A: 12.0±0.5 mm

B: 12.0±0.5 mm

C: 8.0 Max. mm

(2) ELECTRICAL SPECIFICATIONS

SEE TABLE 1

TEST INSTRUMENTS

L : HP 4284A PRECISION LCR METER (or equivalent)

RDC : CHROMA MODEL 16502 MILLIOHM METER (or equivalent)

(3) CHARACTERISTICS

(3)-1 Ambient temperature +60°C Max.

(3)-2 Operate temperature range -40°C ~ +105°C

(Including self temp. rise)

(3)-3 Storage temperature range -40°C ~ +105°C

MATERIALS

NO.	ITEM	DESCRIPTION & TYPE	UL NO.	MANUFACTURER
1	DR CORE	FERRITE		SHINN DER ELECTRONIC CO., LTD. TAK TECHNOLOGY CO., LTD.
2	RING CORE	FERRITE		SHINN DER ELECTRONIC CO., LTD. TAK TECHNOLOGY CO., LTD.
3	WIRE	POLYURETHANE ENAMELLED COPPER WIRE	E84201 E258243	TA YA ELECTRICAL CO., LTD. ELEKTRISOLA CO., LTD.
4	SOLDER	Sn99.3%/Cu0.7%		SHENMAO TECHNOLOGY INC. OR EQUIV.
5	ADHESIVE	EPOXY RESIN (FOR RING CORE ASSEMBLY)		SHAW HUOW ENTERPRISE CO., LTD. OR EQUIV.
6	ADHESIVE	EPOXY RESIN (FOR PIN BASE ASSEMBLY)		SHAW HUOW ENTERPRISE CO., LTD. OR EQUIV.
7	PIN BASE	C1100		HAINING XINCHENG ELECTRONIC CO., LTD. OR EQUIV.
8	INK	BON MARQUE INK UV INK		T&K TOKA. FUJI CHEMICAL (KUNSHAN) CO., LTD.



MAG.LAYERS

TABLE 1

MAGLAYERS PT/NO.	Inductance L(μ H)	Percent Tolerance	Test Frequency	Resistance RDC(Ω)Max.	Rated DC Current		Marking
					IDC1(A)	IDC2(A)	
MSCDRI-127A-3R3□-RU	3.3	N	100kHz/0.25V	13.5m	13.5	7.5	3R3
MSCDRI-127A-4R7□-RU	4.7	N	100kHz/0.25V	15.8m	11.5	6.8	4R7
MSCDRI-127A-5R6□-RU	5.6	N	100kHz/0.25V	16.8m	10.5	6.7	5R6
MSCDRI-127A-6R8□-RU	6.8	N	100kHz/0.25V	17.6m	9.5	6.6	6R8
MSCDRI-127A-100□-RU	10	M,N	100kHz/0.25V	21.6m	7.8	5.4	100
MSCDRI-127A-120□-RU	12	M,N	100kHz/0.25V	24.3m	7.3	4.9	120
MSCDRI-127A-150□-RU	15	M,N	100kHz/0.25V	27.0m	6.5	4.5	150
MSCDRI-127A-180□-RU	18	M,N	100kHz/0.25V	39.2m	6.0	3.9	180
MSCDRI-127A-220□-RU	22	M,N	100kHz/0.25V	43.2m	5.3	3.6	220
MSCDRI-127A-330□-RU	33	M,N	100kHz/0.25V	64.8m	4.3	3.0	330
MSCDRI-127A-470□-RU	47	M,N	100kHz/0.25V	0.10	3.8	2.5	470
MSCDRI-127A-560□-RU	56	M,N	100kHz/0.25V	0.11	3.4	2.35	560
MSCDRI-127A-680□-RU	68	M,N	100kHz/0.25V	0.14	3.1	2.10	680
MSCDRI-127A-820□-RU	82	M,N	100kHz/0.25V	0.16	2.7	1.95	820
MSCDRI-127A-101□-RU	100	M,N	100kHz/0.25V	0.22	2.5	1.70	101
MSCDRI-127A-121□-RU	120	M,N	100kHz/0.25V	0.25	2.3	1.60	121
MSCDRI-127A-151□-RU	150	M,N	100kHz/0.25V	0.28	2.0	1.42	151
MSCDRI-127A-181□-RU	180	M,N	100kHz/0.25V	0.35	1.9	1.30	181
MSCDRI-127A-221□-RU	220	M,N	100kHz/0.25V	0.39	1.7	1.16	221
MSCDRI-127A-331□-RU	330	M,N	100kHz/0.25V	0.64	1.4	0.95	331
MSCDRI-127A-391□-RU	390	M,N	100kHz/0.25V	0.70	1.3	0.88	391
MSCDRI-127A-471□-RU	470	M,N	100kHz/0.25V	0.98	1.1	0.79	471
MSCDRI-127A-681□-RU	680	M	100kHz/0.25V	1.10	1.0	0.70	681
MSCDRI-127A-152□-RU	1500	M	100kHz/0.25V	2.20	0.7	0.55	152

※ □ specify the inductance tolerance, M($\pm 20\%$), N($\pm 30\%$)

※ IDC1 : Based on inductance change ($\Delta L/L_0 : \leq -10\%$) @ambient temperature 25°C

IDC2 : Based on temperature rise ($\Delta T : 40^\circ\text{C TYP.}$)

Rated DC Current : The less value which is IDC1 or IDC2.



MAG.LAYERS

(4) RELIABILITY TEST METHOD MECHANICAL

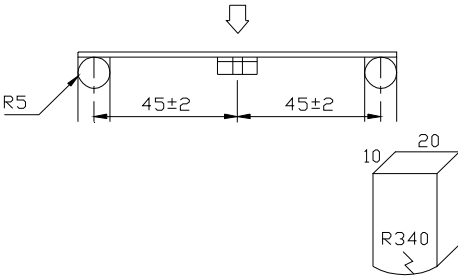
TEST ITEM	SPECIFICATION	TEST DETAILS
Substrate bending	$\Delta L/L_0 \leq \pm 5\%$ There shall be no mechanical damage or electrical damage.	<p>The sample shall be soldered onto the printed circuit board in figure 1 and a load applied until the figure in the arrow direction is made approximately 3mm.(keep time 30 seconds) PCB dimension shall the page 7/9</p> <p>F(Pressurization)</p>  <p>10 20 R340</p> <p>PRESSURE ROD figure-1</p>
Vibration	$\Delta L/L_0 \leq \pm 5\%$ There shall be no mechanical damage.	<p>The sample shall be soldered onto the printed circuit board and when a vibration having an amplitude of 1.52mm and a frequency of from 10 to 55Hz/1 minute repeated should be applied to the 3 directions (X,Y,Z) for 2 hours each. (A total of 6 hours)</p>
Solderability	New solder More than 90%	<p>Flux (rosin, isopropyl alcohol{JIS-K-1522}) shall be coated over the whole of the sample before hard, the sample shall then be preheated for about 2 minutes in a temperature of 130~150°C and after it has been immersed to a depth 0.5mm below for 3±0.2 seconds fully in molten solder M705 with a temperature of 245±5°C.</p> <p>More than 90% of the electrode sections shall be covered with new solder smoothly when the sample is taken out of the solder bath.</p>

MECHANICAL

TEST ITEM	SPECIFICATION	
Resistance to Soldering heat (reflow soldering)	There shall be no damage or problems.	<p style="text-align: center;">Temperature profile of reflow soldering</p> <p>The graph shows the soldering temperature profile. The y-axis is 'Soldering temperature (°C)' ranging from 50 to 300. The x-axis represents time. The profile starts at 50°C, rises to 150°C, and remains there for 2 minutes (Pre-heating). It then rises to a peak of 260±3°C for 10 seconds (soldering). It then drops to 230±10°C and remains there for 30 seconds minimum (30 sec Min (230^{±10} °C)). Finally, it cools down slowly (Slow cooling (Stored at room temperature)).</p> <p>The specimen shall be passed through the reflow oven with the condition shown in the above profile for 1 time.</p> <p>The specimen shall be stored at standard atmospheric conditions for 1 hour, after which the measurement shall be made.</p>

ELECTRICAL

TEST ITEM	SPECIFICATION	TEST DETAILS
Temperature characteristics	$\Delta L/L20^{\circ}\text{C} \leq \pm 10\%$ 0~2000 ppm/°C	The test shall be performed after the sample has stabilized in an ambient temperature of -20 to +85°C, and the value calculated based on the value applicable in a normal temperature and normal humidity shall be $\Delta L/L20^{\circ}\text{C} \leq \pm 10\%$.



ENVIROMENT CHARACTERISTICS

TEST ITEM	SPECIFICATION																
High temperature storage	$\Delta L/Lo \leq \pm 5\%$ There shall be no mechanical damage.	The sample shall be left for 96 ± 4 hours in an atmosphere with a temperature of $85 \pm 2^\circ\text{C}$ and a normal humidity. Upon completion of the measurement shall be made after the sample has been left in a normal temperature and normal humidity for 1 hour.															
Low temperature storage	$\Delta L/Lo \leq \pm 5\%$ There shall be no mechanical damage.	The sample shall be left for 96 ± 4 hours in an atmosphere with a temperature of $-25 \pm 3^\circ\text{C}$. Upon completion of the test, the measurement shall be made after the sample has been left in a normal temperature and normal humidity for 1 hour.															
Change of temperature	$\Delta L/Lo \leq \pm 5\%$ There shall be no other damage of problems	The sample shall be subject to 5 continuous cycles, such as shown in the table 2 below and then it shall be subjected to standard atmospheric conditions for 1 hour, after which measurement shall be made. <div style="text-align: center;"> table 2 <table border="1" style="margin: auto;"> <thead> <tr> <th></th> <th style="text-align: center;">Temperature</th> <th style="text-align: center;">Duration</th> </tr> </thead> <tbody> <tr> <td style="text-align: center;">1</td> <td style="text-align: center;">$-25 \pm 3^\circ\text{C}$ (Thermostat No.1)</td> <td style="text-align: center;">30 min.</td> </tr> <tr> <td style="text-align: center;">2</td> <td style="text-align: center;">Standard atmospheric</td> <td style="text-align: center;">5 sec. or less No.1→No.2</td> </tr> <tr> <td style="text-align: center;">3</td> <td style="text-align: center;">$85 \pm 2^\circ\text{C}$ (Thermostat No.2)</td> <td style="text-align: center;">30 min.</td> </tr> <tr> <td style="text-align: center;">4</td> <td style="text-align: center;">Standard atmospheric</td> <td style="text-align: center;">5 sec. or less No.2→No.1</td> </tr> </tbody> </table> </div>		Temperature	Duration	1	$-25 \pm 3^\circ\text{C}$ (Thermostat No.1)	30 min.	2	Standard atmospheric	5 sec. or less No.1→No.2	3	$85 \pm 2^\circ\text{C}$ (Thermostat No.2)	30 min.	4	Standard atmospheric	5 sec. or less No.2→No.1
	Temperature	Duration															
1	$-25 \pm 3^\circ\text{C}$ (Thermostat No.1)	30 min.															
2	Standard atmospheric	5 sec. or less No.1→No.2															
3	$85 \pm 2^\circ\text{C}$ (Thermostat No.2)	30 min.															
4	Standard atmospheric	5 sec. or less No.2→No.1															
Moisuture storage	$\Delta L/Lo \leq \pm 5\%$ There shall be no mechanical damage.	The sample shall be left for 96 ± 4 hours in a temperature of $40 \pm 2^\circ\text{C}$ and a humidity(RH) of 90~95%. Upon completion of the test, the measurement shall be made after the sample has been left in a normal temperature and normal humidity more than 1 hour.															
Test conditions : The sample shall be reflow soldered onto the printed circuit board in every test.																	



(5) LAND DIMENSION (Ref.)

PCB: GLASS EPOXY $t=1.6\text{mm}$

(5)-1 LAND PATTERN DIMENSIONS

(STANDARD PATTERN) Unit:mm

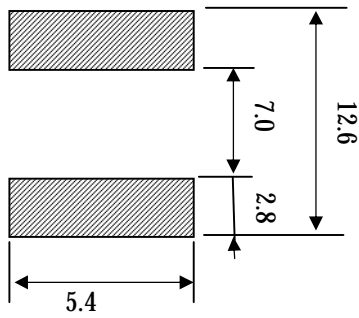

(5)-2 SUBSTRATE BENDING TEST BENDING TEST BOARD

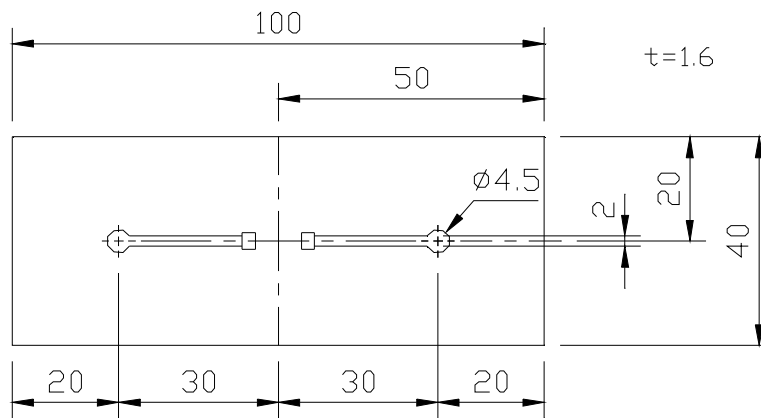

(6) PACKAGING
(6)-1 CARRIER TAPE DIMENSIONS (mm)

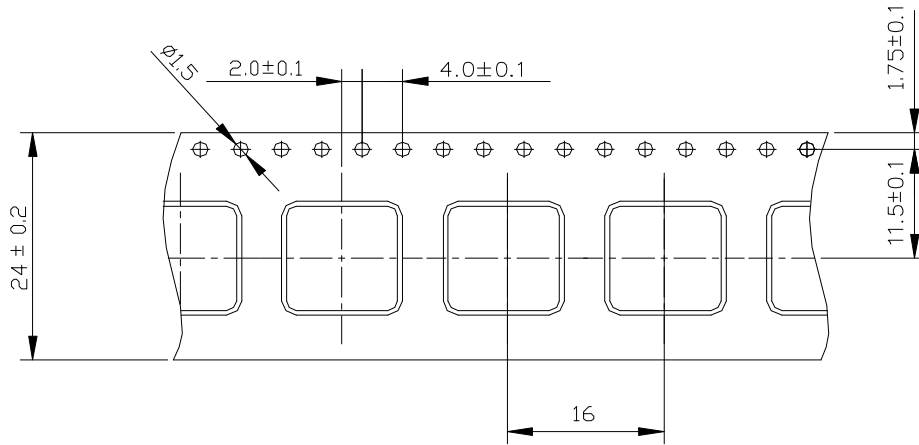

(6)-2 TAPING DIMENSIONS (mm)

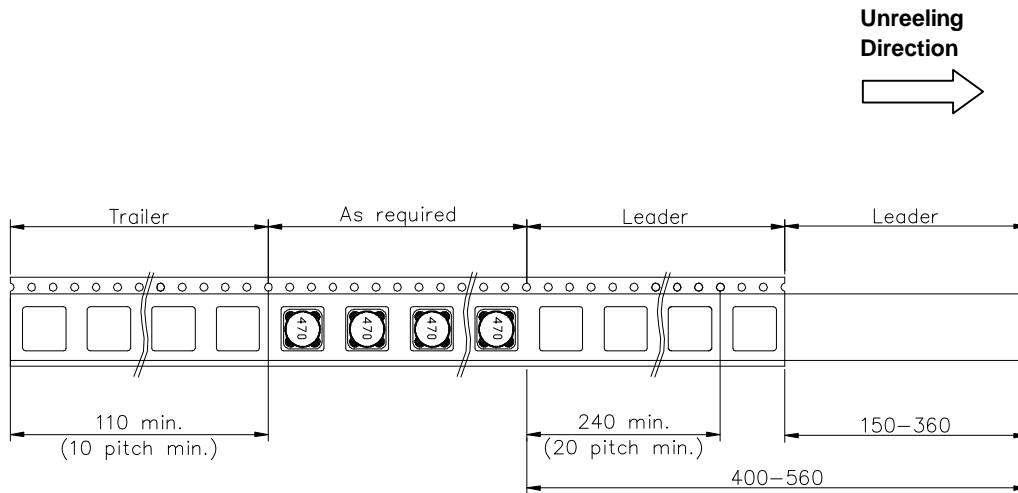

(6)-3 REEL DIMENSIONS (mm)

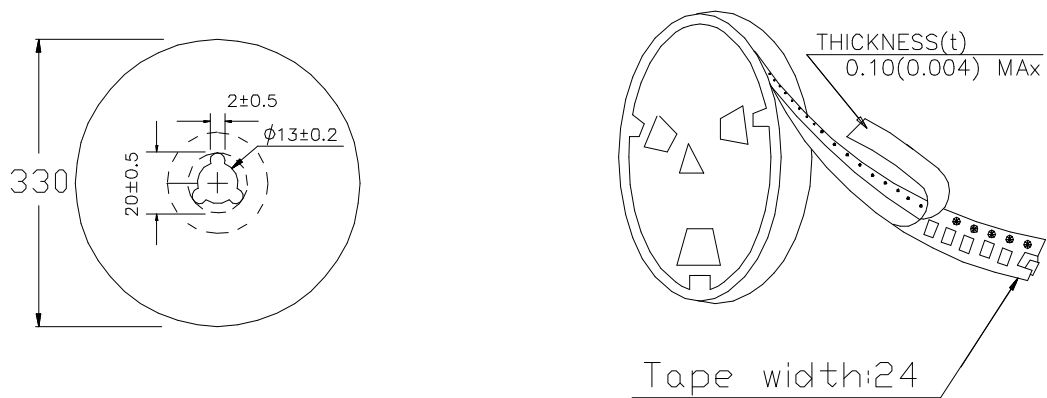

(6)-4 QUANTITY

500pcs/Reel

The products are packaged so that no damage will be sustained.



MAG.LAYERS