

# Single Row Terminal Blocks

## A0 & CB0

### Dimensions- Inches (Millimeters)

#### A0

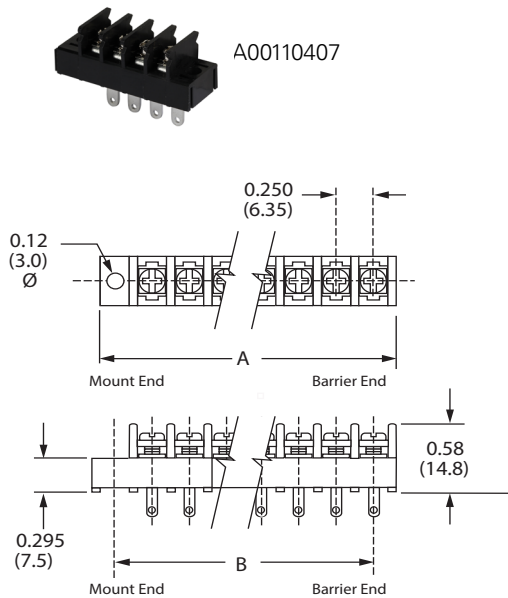

#### CB0

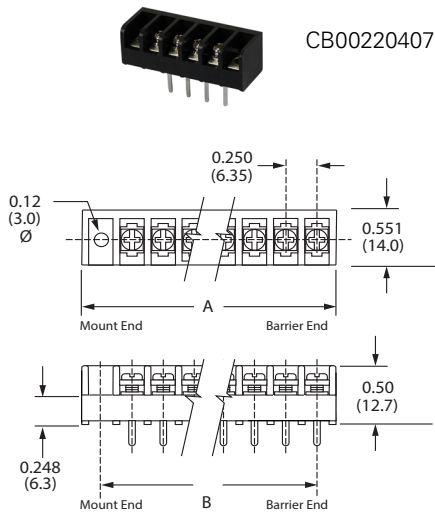

### Specifications

**Rating:** 10 A, 300 V

**Center Spacing:** 0.25" (6.35 mm)

**Wire Range:** #16-30 AWG

**Screw Size:** M3.0 nickel-plated steel SEMS

**Torque Rating:** 10 lb-in.

**Recommended PCB Hole Diameter:** 1.6 mm - 1.8 mm

**Operating Temperature:** -40 °C to +120 °C

**Body Material:** Polyamide 66, UL94 V-0, Black

**Terminal Material:** Brass, tin plated

**Breakdown Voltage:** 2000 V

**Agency Information:** UL file E62622

Poles	MOUNTING ENDS		BARRIER ENDS	
	A Length	B Mount Centers	A Length	B End Pole Centers
02	1.04	0.79	0.54	0.25
03	1.29	1.04	0.79	0.50
04	1.54	1.29	1.04	0.75
05	1.79	1.54	1.29	1.00
06	2.04	1.79	1.54	1.25
07	2.29	2.04	1.79	1.50
08	2.54	2.29	2.04	1.75
09	2.79	2.54	2.29	2.00
10	3.04	2.79	2.54	2.25
11	3.29	3.04	2.79	2.50
12	3.54	3.29	3.04	2.75
13	3.79	3.54	3.29	3.00
14	4.04	3.79	3.54	3.25
15	4.29	4.04	3.79	3.50
16	4.54	4.29	4.04	3.75
17	4.79	4.54	4.29	4.00
18	5.04	4.79	4.54	4.25
19	5.29	5.04	4.79	4.50
20	5.54	5.29	5.04	4.75
21	5.79	5.54	5.29	5.00
22	6.04	5.79	5.54	5.25
23	6.29	6.04	5.79	5.50
24	6.54	6.29	6.04	5.75
25	6.79	6.54	6.29	6.00
26	7.04	6.79	6.54	6.25
27	7.29	7.04	6.79	6.50
28	7.54	7.29	7.04	6.75
29	7.79	7.54	7.29	7.00
30	8.04	7.79	7.54	7.25

Dimensions in inches. To convert to millimeters, multiply by 25.4.









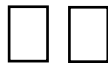

Powering Business Worldwide

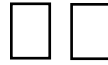
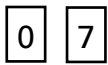
# A0 & CB0

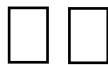
Single Row Terminal Blocks

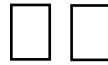
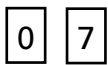
## Part Numbering System

Family	Terminal Style	Base/End	Poles	Screw Options	Options
 <b>A0</b> - standard barrier	 <b>01</b> - handwired <b>02</b> - printed circuit	 <b>1</b> - mount end <b>2</b> - barrier end	 <b>02 to 30</b>	 <b>07</b> - steel SEMS fully seated	 <b>C1 to C8</b> - 0.110" QC <b>L1 to L6</b> marking options (pg 25) <b>Covers</b> - (pg 26)
 <b>CB0</b> - closed back	 <b>02</b> - printed circuit <b>04</b> - wire wrap tail	 <b>1</b> - mount end <b>2</b> - barrier end	 <b>02 to 30</b>	 <b>07</b> - steel SEMS fully seated	 <b>C1 to C8</b> - 0.110" QC <b>L1 to L6</b> marking options (pg 25)

## Terminal Styles- Inches(Millimeters)

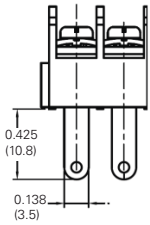

**01**  
Handwired

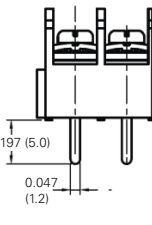
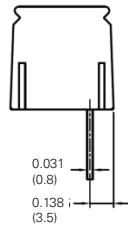

**02**  
Circuit Board

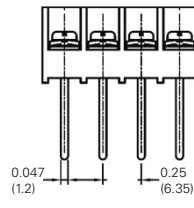
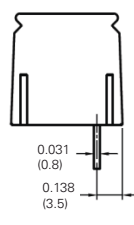

**04**  
Wire Wrap Tail

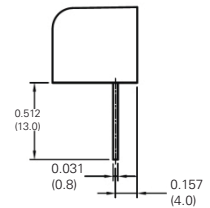

## Screw Options

(Bulk ordering part numbers are in parentheses)



**07**  
Steel SEMS nickel-plated  
(ACB0-SC)

## Hardware Options

(Bulk ordering part numbers are in parentheses)

**Quick Connects** Blade Width 0.110" (For other orientations, contact factory)

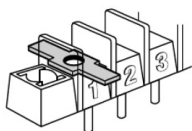

**C1 (5C1-J)**

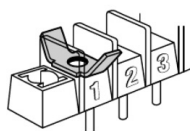

**C2 (5C2-J)**

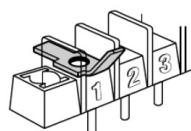

**C4 (5C4-J)**

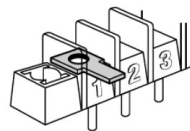

**C7 (5C7-J)**

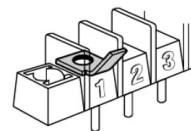

**C8 (5C8-J)**

# Single Row Terminal Blocks

## A1

### Dimensions Inches (Millimeters)

A1

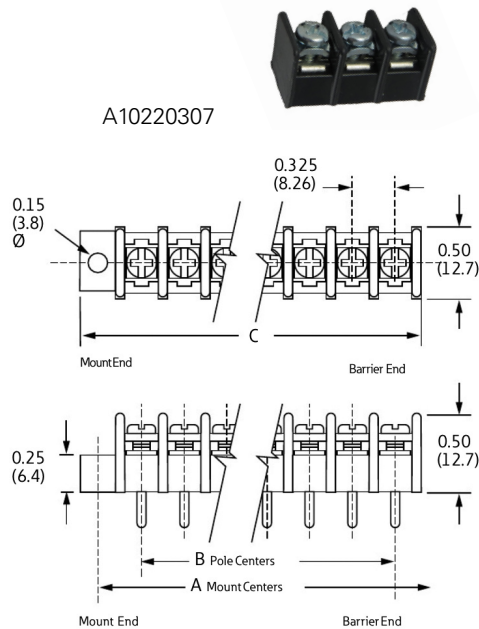

Eaton's single row terminal blocks may, on occasion, have various cosmetic variations on their ends due to machining operations that achieve the proper number of poles required. Cutting and machining blemishes are permissible and have no effect on the fit, form or function of the product.

### Specifications

**UL Rating:** 20A, 250V\*

**CSA Rating:** 15A, 150V or 10A, 300V\*

**Center Spacing:** 0.325" (8.26mm)

**Wire Range:** #14-22 AWG Cu

**Screw Size:** #6-32 zinc-plated phillot wire-ready screws with a #2 driving recess.

**Torque Rating:** 9 lb-in.

**Distance Between Barriers:** 0.26" (6.6mm)

**Recommended PCB Hole Diameter:** 0.070" (1.78mm)

**Operating Temperature:** -40°C to 105°C (-40°F to 221°F) .

**Molded Material:** Black, UL Rated 94V0 Thermoplastic

**Breakdown Voltage:** 1600V

**Agency Information:** UL1059 (File:E62622); CSA std C22.2 No. 158-10 (File: 15364); Complies to IEC 60947-7-1; CE

\* Consult respective agency standards and files for full details







Poles	MOUNTING ENDS ONLY		BARRIER & MOUNTING ENDS	BARRIER ENDS ONLY
	A Mounting Ctrs.	C Length	B Pole Ctrs.	C Length
02	0.98	1.37	0.33	0.72
03	1.30	1.69	0.65	1.04
04	1.63	2.02	0.98	1.37
05	1.95	2.34	1.30	1.69
06	2.28	2.67	1.63	2.02
07	2.60	2.99	1.95	2.34
08	2.93	3.32	2.28	2.67
09	3.25	3.64	2.60	2.99
10	3.58	3.97	2.93	3.32
11	3.90	4.29	3.25	3.64
12	4.23	4.62	3.58	3.97
13	4.55	4.94	3.90	4.29
14	4.88	5.27	4.23	4.62
15	5.20	5.59	4.55	4.94
16	5.53	5.92	4.88	5.27
17	5.85	6.24	5.20	5.59
18	6.18	6.57	5.53	5.92
19	6.50	6.89	5.85	6.24
20	6.83	7.22	6.18	6.57
21	7.15	7.54	6.50	6.89
22	7.48	7.87	6.83	7.22
23	7.80	8.19	7.15	7.54
24	8.13	8.52	7.48	7.87
25	8.45	8.84	7.80	8.19
26	8.78	9.17	8.13	8.52
27	9.10	9.49	8.45	8.84
28	9.43	9.82	8.78	9.17
29	9.75	10.14	9.10	9.49
30	10.08	10.47	9.43	9.82

Dimensions in inches. To convert to millimeters, multiply by 25.4.



Powering Business Worldwide

### Part Numbering System

Family	Terminal Style	Base/End	Poles	Screw Options	Options
 <p><b>A1</b> - standard barrier <b>CB1</b> - closed back</p>	 <p><b>02</b> - printed circuit <b>04</b> - wire wrap <b>07</b> - extended pin</p>	 <p><b>1</b> - mount end <b>2</b> - barrier end</p>	 <p><b>02 to 24</b> A1 <b>02 to 30</b> CB1</p>	 <p>Blank-std. screws <b>03</b>- stainless steel <b>07</b>- steel SEMS &amp; washer (not available with hardware options)</p>	 <p><b>DR</b> - angle mts. (A1 only-pg 5) <b>B1 to B9</b> - 0.187" QC (all positions) <b>L1 to L6</b> marking options (pg 25) <b>LT1 to LT6</b> marking options (CB1 only-pg 25) <b>MP &amp; MT</b> - mounting plates 0.150 dia (pg 5) <b>R26</b> - rightangle bends (A1 only-pg 5)</p>

### Terminal Styles Inches (Millimeters)

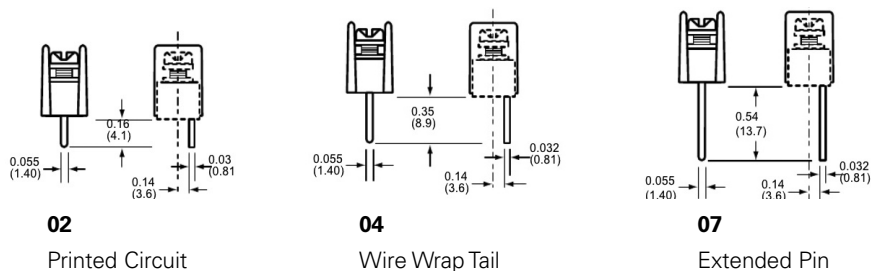

### Screw Options Wire ready screws standard on all terminal styles

(Bulk ordering part numbers are in parentheses)



**Standard**  
Zinc-Plated Steel (F508-J)



**03**  
Stainless Steel (F510-J)



**07**  
Zinc-Plated Steel Screws (F522-J)

### Hardware Options Inches (Millimeters)

(Bulk ordering part numbers are in parentheses)

#### Jumpers

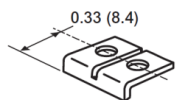

(JA1-xx-J)

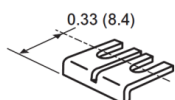

(JB1-xx-J)

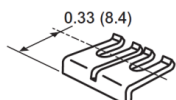

(JC1-xx-J)

#### Quick Connects Blade Width B = 0.187"

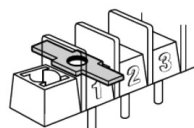

**B1 (1B1-J)\*\***

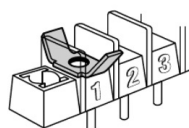

**B2 (1B2-J)\*\***

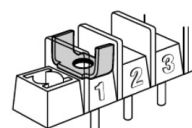

**B3 (1B3-J)\*\***

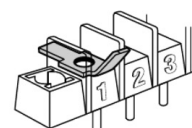

**B4 (1B4-J)\*\***

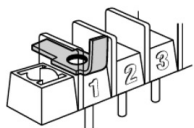

**B5 (1B5-J)\*\***

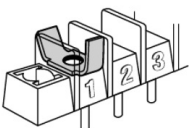

**B6 (1B6-J)\*\***

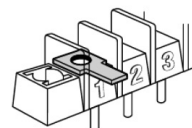

**B7 (1B7-J)**

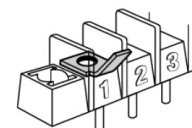

**B8 (1B8-J)**

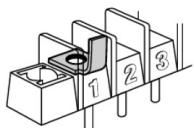

**B9 (1B9-J)**

\*Contact Eaton for desired configuration

\*\* N/A on CB1



## Mounting Options

### Right Angle Bends (A1 only)

Right angle terminals are offered on the A1. Configurations are defined in these dimensions: X = pin extension beyond the block base; Z = length from block base to centerline of the terminal tip. Standard bends consist of the X and Z dimensions shown in the chart. Specify by adding the R26 Bend Option Code to the terminal part number.

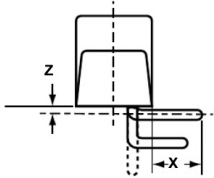

Bend Option Code	X	Z
R26 (04 terminal only)	0.14 (3.5)	0.09 (2.3)

Dimensions: in (mm)

### Right Angle Bends (A1 only)

(Dimensions in inches)

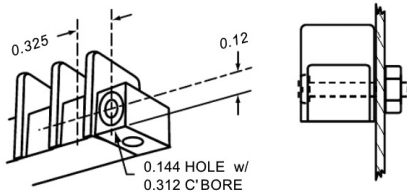

### Option DR

Counterbored holes across mount ends of block enable fastening with two screws at right angles to normal mount position.

### Mounting Plates

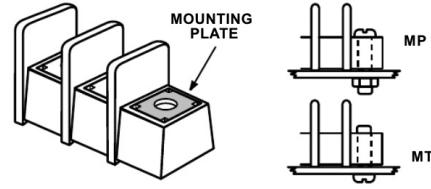

### Options MP & MT

**MP** Metal inserts with 0.150" (3.8) dia. hole accept #6 screw.

**MT** Metal inserts with tapped hole accept #6-32 screw.

Bulk part numbers **1MP-J** & **1MT-J**.

# Single Row Terminal Blocks

## CB11

### Dimensions Inches (Millimeters)

#### CB11



CB11720407

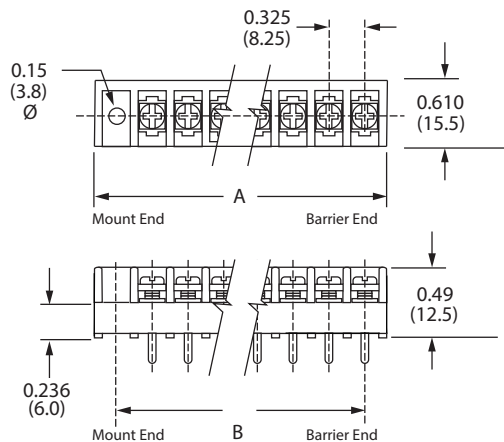

### Specifications

**Rating:** 15 A, 300 V

**Center Spacing:** 0.325" (8.25 mm)

**Wire Range:** #14-22 AWG

**Screw Size:** M3.0, nickel-plated steel

**Torque Rating:** 12 lb-in.

**Recommended PCB Hole Diameter:** 1.6 mm - 1.8 mm

**Operating Temperature:** -40 °C to +120 °C

**Body Material:** Polyamide 66, UL94 V-0, Black

**Terminal Material:** Brass, tin plated

**Breakdown Voltage:** 2000 V

**Agency Information:** UL file E62622

Poles	MOUNTING ENDS		BARRIER ENDS	
	A Length	B Mount Centers	A Length	B End Pole Centers
02	1.35	0.65	0.70	0.32
03	1.67	0.97	1.02	0.65
04	2.00	1.30	1.35	0.97
05	2.32	1.62	1.67	1.30
06	2.65	1.95	2.00	1.62
07	2.97	2.27	2.32	1.95
08	3.30	2.60	2.65	2.27
09	3.62	2.92	2.97	2.60
10	3.94	3.25	3.30	2.92
11	4.27	3.57	3.62	3.25
12	4.59	3.90	3.94	3.57
13	4.92	4.22	4.27	3.90
14	5.24	4.55	4.59	4.22
15	5.57	4.87	4.92	4.55
16	5.89	5.20	5.24	4.87
17	6.22	5.52	5.57	5.20
18	6.54	5.85	5.89	5.52
19	6.87	6.17	6.22	5.85
20	7.19	6.50	6.54	6.17
21	7.52	6.82	6.87	6.50
22	7.84	7.15	7.19	6.82
23	8.17	7.47	7.52	7.15
24	8.49	7.80	7.84	7.47
25	8.82	8.12	8.17	7.80
26	9.14	8.44	8.49	8.12
27	9.47	8.77	8.82	8.44
28	9.79	9.09	9.14	8.77
29	10.12	9.42	9.47	9.09
30	10.44	9.74	9.79	9.42

Dimensions in inches. To convert to millimeters, multiply by 25.4.



Powering Business Worldwide

## Part Numbering System

**Family**



**CB1** - closed back

**Terminal Style**



**12** - printed circuit

**17** - extended pin

**Base/End**



**1** - mount end

**2** - barrier end

**Poles**

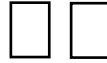

**02 to 30**

**Screw Options**

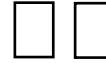

**03** - stainless steel

**07** - steel SEMS

**Options**

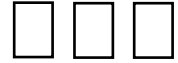

**B1 to B9** - 0.187" QC

**L1 to L6** - marking options (pg 25)

**LT1 to LT6** - marking options (pg 25)

## Terminal Styles- Inches(Millimeters)

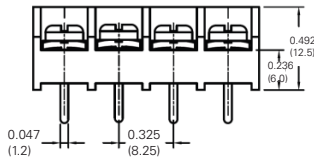

**12**

Printed Circuit

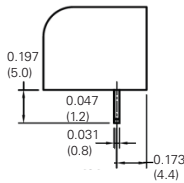

**17**

Extended Pin

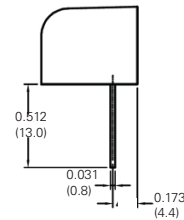
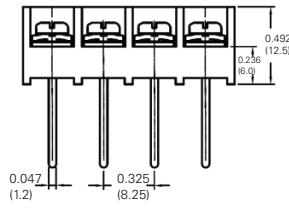

## Screw Options

(Bulk ordering part numbers are in parentheses)



**03**

Stainless steel  
(CB1-SSSC)

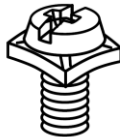

**07**

Steel SEMS Nickel-plated  
(CB1-STSC)

## Hardware Options

(Bulk ordering part numbers are in parentheses)

**Jumpers**

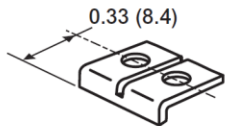

(JA1-xx-J)

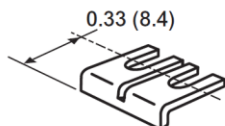

(JB1-xx-J)

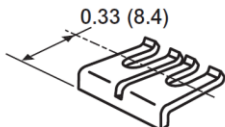

(JC1-xx-J)

**Quick Connects** Blade Width B = 0.187". (For other orientations, contact factory.)

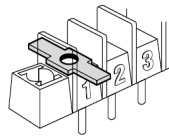

**B1 (1B1-J)**

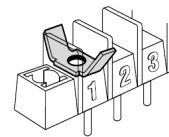

**B2 (1B2-J)**

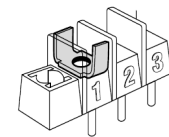

**B3 (1B3-J)**

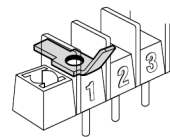

**B4 (1B4-J)**

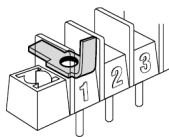

**B5 (1B5-J)**

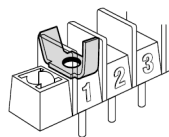

**B6 (1B6-J)**

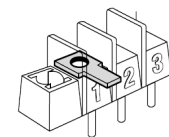

**B7 (1B7-J)**

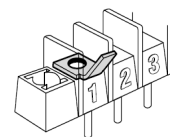

**B8 (1B8-J)**

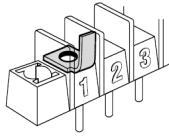

**B9 (1B9-J)**

## Single Row Terminal Blocks

# A2, LP2 & CB2

### Dimensions Inches (Millimeters)

#### A2 & LP2

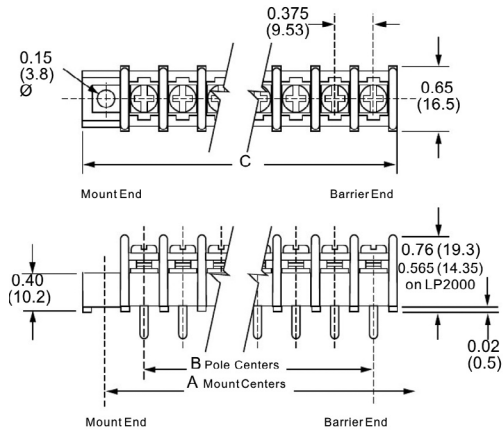
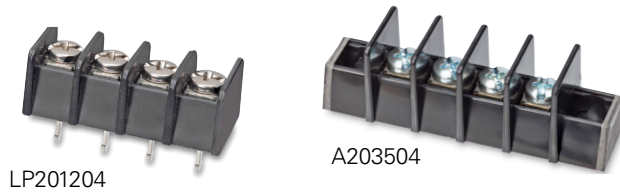

#### CB2

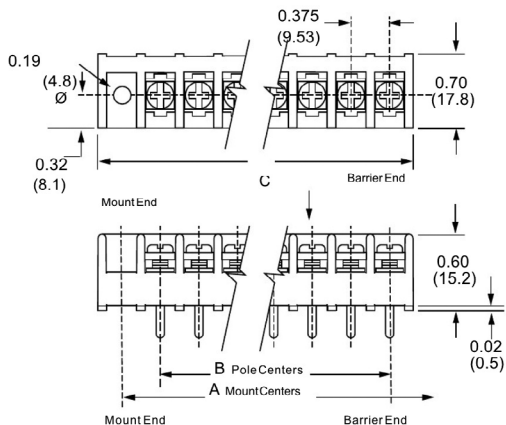

### Specifications

**Rating:** A2: 30A, 300V\*    LP2: 30A, 150V\*    CB2: 30A, 300V\*

**Center Spacing:** 0.375" or 3/8" (9.52mm)

**Wire Range:** #12-22 AWG Cu

**Screw Size:** #6-32 zinc-plated phillslot

**Torque Rating:** 9 lb-in.

**Base:** Standoffs standard for easy flux washing

**Distance Between Barriers:** 0.32" (8.1mm)

**Recommended PCB Hole Diameter:** 0.076" (1.93mm)

**Operating Temperature:** 105°C (221°F) max., -40°C (-40°F) min.

**Molded Material:** Black, UL Rated 94V0 Thermoplastic

**Breakdown Voltage:** 3400V (A2 & LP2); 4100V (CB2).

**Agency Information:** UL File E62622, CSA File 47235; IEC Compliance; CE Certified

\* 30A Rating achieved with a #10 copper wire crimped to a ring terminal.; 20A Rating without ring terminal.

Poles	MOUNTING ENDS ONLY		BARRIER & MOUNTING ENDS	
	A Mounting Ctrs.	C Length	B Pole Ctrs.	C Length
02	1.13	1.56	0.38	0.81
03	1.50	1.93	0.75	1.18
04	1.88	2.30	1.13	1.56
05	2.25	2.68	1.50	1.93
06	2.63	3.06	1.88	2.31
07	3.00	3.43	2.25	2.68
08	3.38	3.81	2.63	3.06
09	3.75	4.18	3.00	3.43
10	4.13	4.56	3.38	3.81
11	4.50	4.93	3.75	4.18
12	4.88	5.31	4.13	4.56
13	5.25	5.69	4.50	4.93
14	5.63	6.06	4.88	5.31
15	6.00	6.43	5.25	5.68
16	6.38	6.81	5.63	6.06
17	6.75	7.18	6.00	6.43
18	7.13	7.56	6.38	6.81
19	7.50	7.93	6.75	7.18
20	7.88	8.31	7.13	7.56
21	8.25	8.68	7.50	7.93
22	8.63	9.06	7.88	8.31
23	9.00	9.43	8.25	8.68
24	9.38	9.81	8.63	9.06
25	—	—	9.00	9.43
26	—	—	9.38	9.81



Powering Business Worldwide

Eaton's single row terminal blocks may, on occasion, have various cosmetic variations on their ends due to machining operations that achieve the proper number of poles required. Cutting and machining blemishes are permissible and have no effect on the fit, form or function of the product.

## Part Numbering System

### Family

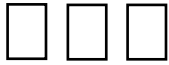

**A2** - standard barrier  
**LP2** - low profile barrier

### Terminal Style

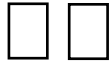

**01\*** - handwired  
**02** - printed circuit  
**03** - non feed-thru  
**04** - wire wrap tail  
**06** - handwired  
**07** - extended pin  
**08** - printed circuit  
**09** - 0.250" QC short  
**10** - 0.187" QC  
**14** - printed circuit  
**19** - 0.250" QC long

### Base/End



**1** - std. base/mnt. end  
**2** - std. base/barrier end on mount  
**3** - insulator base/mnt. end  
**4** - insulator base/barrier end  
**5** - closed base/mount end  
**6** - closed base/molded mount end

Base/End  
Note: 5 & 6  
Styles only  
available with 03  
terminals.

### Poles

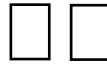

**02 to 26** Barrier end  
**02 to 24** Mount end

### Screw Options

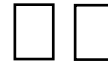

Blank-std. screws  
**00** - screws shipped bulk  
**03\*** - stainless steel  
**04** - brass nickel-plated  
**07** - steel SEMS\*\*\*  
**09\*** - brass SEMS nickel-plated\*\*\*  
**CA\*\*** - captive screw  
**WR\*** - wire ready

### Options

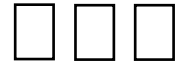

**AB\*** - angle mnt. options (pg 11)  
**A1 to A9** - 0.250" QC  
**B1 to B9** - 0.187" QC  
**DR\*** - drilled right angle (pg 11)  
**L1 to L6** marking options (pg 25)  
**MP\*** mounting plates (pg 11)  
**R30 to R75** - right angle bends (pg 11)  
**S1\*** - solder lug/flat  
**Covers** - (pg 26)

\* A2 only.

\*\* Not compatible with 03-stainless steel screws.

\*\*\* SEMS screws not available with hardware options

## Terminal Styles Inches (Millimeters)

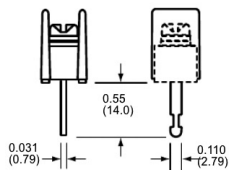

**01**  
Handwired

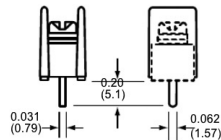

**02**  
Printed Circuit



**03**  
Non Feed-Thru

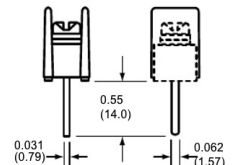

**04**  
Wire Wrap Tail

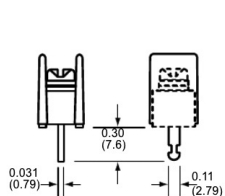

**06**  
Handwired

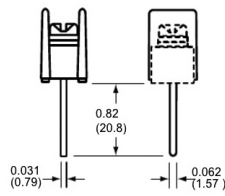

**07**  
Extended Pin

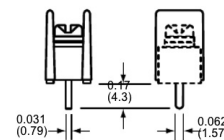

**08**  
Printed Circuit

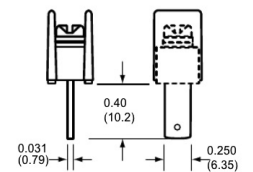

**09**  
0.250" QC short

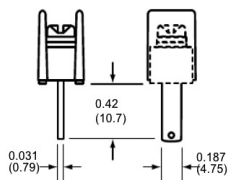

**10**  
0.187" QC

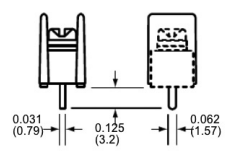

**14**  
Printed Circuit

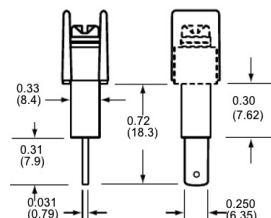

**19**  
0.250" QC long

### Screw Options

(Bulk ordering part numbers are in parentheses)



**Standard**  
Zinc-plated Steel  
(F505-J)



**03**  
Stainless Steel  
(F507-J)



**04**  
Brass  
Nickel-Plated  
(F506-J)



**07**  
Steel SEMS  
(F523-J)



**09**  
Brass SEMS  
Nickel-Plated  
(F524-J)



**WR**  
Wire Ready

### Hardware Options Inches (Millimeters)

(Bulk ordering part numbers are in parentheses)

#### Solder Lugs

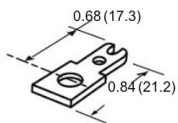

**S1**  
(2S1-J)

#### Jumpers

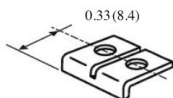

(JA2-xx-J)

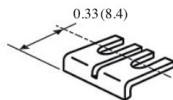

(JB2-xx-J)

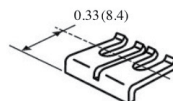

(JC2-xx-J)



†OJ2  
(OJ2-J)



†OJ4  
(OJ4-J)

#### Quick Connects

Blade Width A = 0.250" Blade Width B = 0.187"

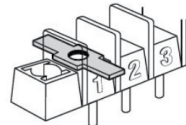

**A1 & B1**  
(2A1-J & 2B1-J)



**A2 & B2**  
(2A2-J & 2B2-J)

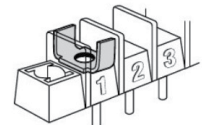

**A3 & B3**  
(2A3-J & 2B3-J)

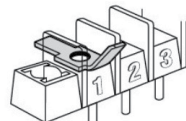

**A4 & B4**  
(2A4-J & 2B4-J)

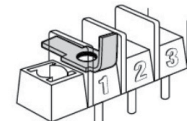

**A5 & B5**  
(2A5-J & 2B5-J)

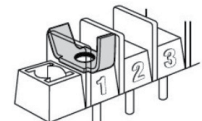

**A6 & B6**  
(2A6-J & 2B6-J)

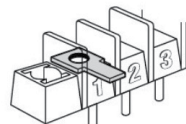

**A7 & B7**  
(2A7-J & 2B7-J)

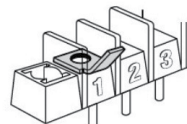

**A8 & B8**  
(2A8-J & 2B8-J)

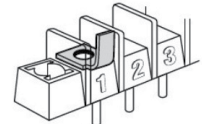

**A9 & B9**  
(2A9-J & 2B9-J)

† Contact Eaton for desired configuration.

### Base/End Options Inches (Millimeters)



**1 - Standard base/mount end**



**2 - Standard base/barrier end**

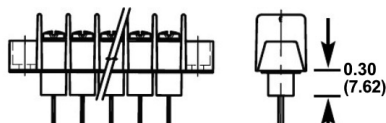

**3 - Insulator base/mount end**

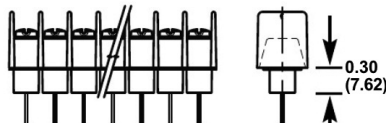

**4 - Insulator base/barrier end**



**5 - Closed base/mount end**



**6 - Closed base/molded mount end**

(not available with covers)

#### Mount End Details

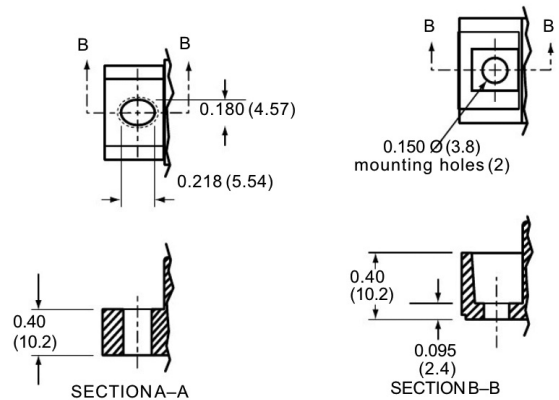

**6**  
**Molded Mount End**

**1, 3 & 5**  
**Mount End**

Note: On 1, 3 and 5 bases, Eaton may drill a terminal spacing to be a mount end. There will be no fit/form/function effect of mounting the product

## Mounting Options Inches (Millimeters)

### Right Angle Bends

Right angle terminals are offered on the A2 & LP2. Configurations are defined in these dimensions: X = pin extension beyond the block base; Z = length from block base to centerline of the terminal tip. Standard bends consist of the X and Z dimensions shown in the chart. Specify by adding the selected Bend Option Code to the terminal part number.

### 04 Terminal Bend Configurations

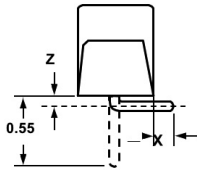

Bend Option Code	X (minimum)	Z	Available with insulator base
R35	0.01	0.23	No
R42	0.08	0.16	No
R46	0.12	0.12	No
R50	0.16	0.08	No

Dimensions in inches. To convert to millimeters, multiply by 25.4.

### Angle Brackets

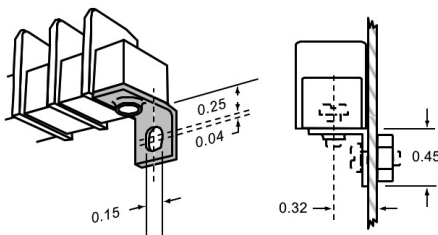

### Option AB

Angle brackets enable block to be fastened at right angles to normal mount position. Bulk part number **2AB-J**.

### Mounting Plates

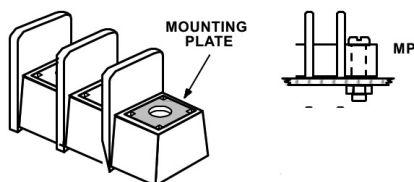

### Options MP

**MP** Metal inserts with 0.150" dia. hole accept #6 screw. Bulk part number **2MP-J**.

### 07 Terminal Bend Configurations

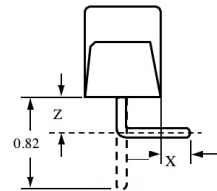

Bend Option Code	X (minimum)	Z	Available with insulator base
R35	0.01	0.50	Yes
R42	0.08	0.43	Yes
R46	0.12	0.39	Yes
R50	0.16	0.35	No
R53	0.19	0.32	No
R66	0.32	0.19	No
R75	0.41	0.10	No

Dimensions in inches. To convert to millimeters, multiply by 25.4.

### Drilled Right Angle

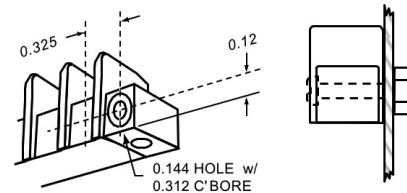

### Option DR

Counterbored holes across mount ends of block enable fastening with two screws at right angles to normal mount position.

### Part Numbering System

Family	Terminal Style	Base/End	Poles	Screw Options	Options
<div style="display: flex; gap: 5px;"> <div style="border: 1px solid black; padding: 2px 5px;">C</div> <div style="border: 1px solid black; padding: 2px 5px;">B</div> <div style="border: 1px solid black; padding: 2px 5px;">2</div> </div> <p>CB2 - closed back</p>	<div style="display: flex; gap: 10px;"> <div style="border: 1px solid black; width: 20px; height: 20px;"></div> <div style="border: 1px solid black; width: 20px; height: 20px;"></div> </div> <p>01 - handwired 02 - printed circuit 07 - extended pin 14 - printed circuit</p>	<div style="border: 1px solid black; width: 20px; height: 20px;"></div> <p>1 - mount end 2 - barrier end</p>	<div style="display: flex; gap: 10px;"> <div style="border: 1px solid black; width: 20px; height: 20px;"></div> <div style="border: 1px solid black; width: 20px; height: 20px;"></div> </div> <p>02 to 26 on barrier end 02 to 24 on mount end</p>	<div style="display: flex; gap: 10px;"> <div style="border: 1px solid black; width: 20px; height: 20px;"></div> <div style="border: 1px solid black; width: 20px; height: 20px;"></div> </div> <p>Blank—std. screws 07 - steel SEMS standard 09 - brass SEMS nickel-plated</p>	<div style="display: flex; gap: 10px;"> <div style="border: 1px solid black; width: 20px; height: 20px;"></div> <div style="border: 1px solid black; width: 20px; height: 20px;"></div> <div style="border: 1px solid black; width: 20px; height: 20px;"></div> </div> <p>AB - angle mounting brackets (pg 13) A7 to A9 - 0.250" QC B7 to B9 - 0.187" QC EB - exit back terminals EF - exit front terminals L1 to L6 marking options (pg 25) LT1 to LT6 marking options (pg 25) MP mtg. plates (pg 13) Covers - (pg 26)</p>

### Terminal Styles Inches (Millimeters)

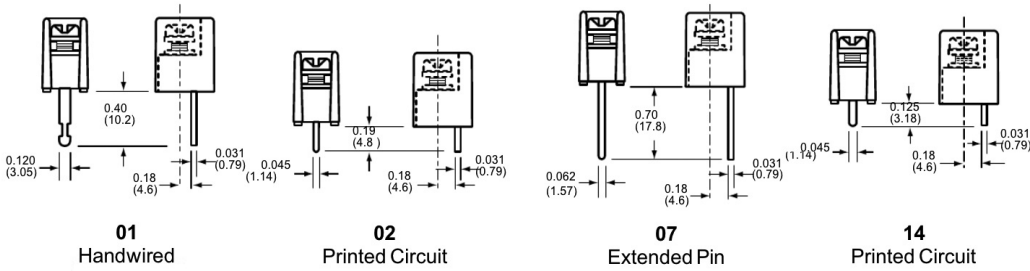

### Screw Options

(Bulk ordering part numbers are in parentheses)

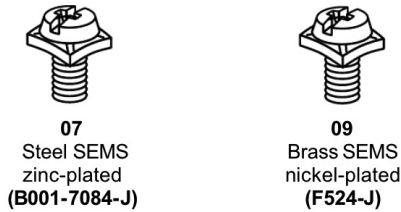

\* NOTE: Wire ready screws standard on all terminal styles.

### CB2 Terminal Exit Options Inches (Millimeters)

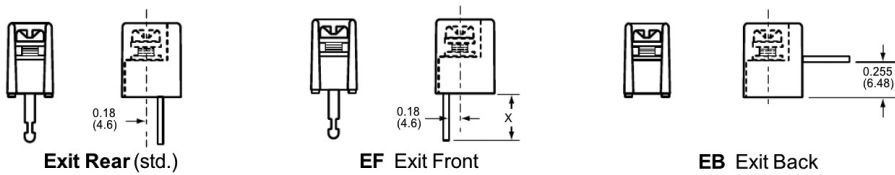



**Hardware Options** Inches (Millimeters)

(Bulk ordering part numbers are in parentheses)

**Jumpers**

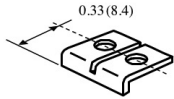

†JA  
(JA2-XX-J)

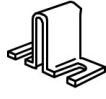

†OJ2  
(OJ2-J)

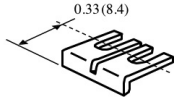

†JB  
(JB2-XX-J)



†OJ4  
(OJ4-J)

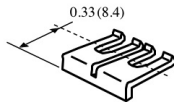

†JC  
(JC2-XX-J)

† Contact Eaton for desired configuration.

**Quick Connects**

Blade Width A = 0.250". Blade Width B = 0.187".

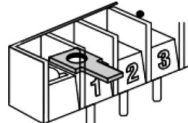

A7 & B7  
(2A7-J & 2B7-J)

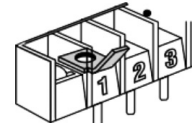

A8 & B8  
(2A8-J & 2B8-J)

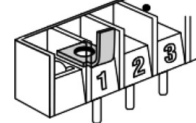

A9 & B9  
(2A9-J & 2B9-J)

**Mounting Options** Inches (Millimeters)

**Right Angle Mounting Bracket**

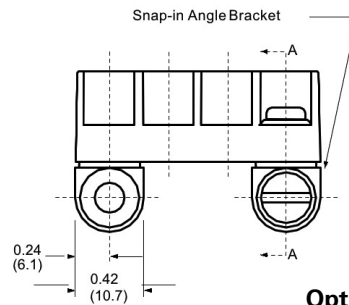
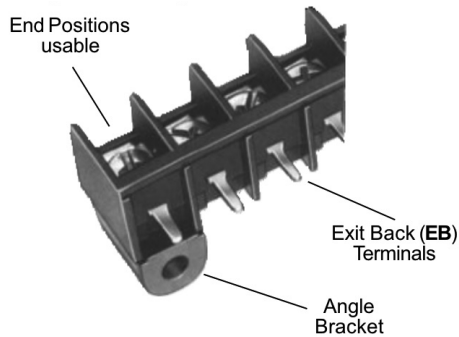

**Option AB**

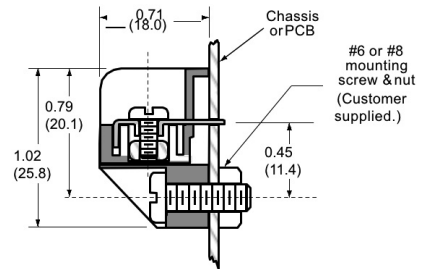

**Mounts blocks on PC boards at a right angle.**

- Protects solder joints.
- Bracket snaps securely on block (no hardware required).
- Minimum strip length (end positions are usable).
- Mount with #6-32 or #8-32 screws (not supplied).
- Available on 3 pole configurations and greater

**Mounting Plates**

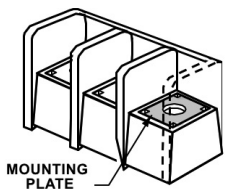

**Option MP**

**MP** Metal inserts with 0.150" dia. hole accept #6 screw.

Bulk part number **2MP-J**.

## Single Row Terminal Blocks

# A3, LP3 & CB3

### Dimensions Inches (Millimeters)

#### A3 & LP3

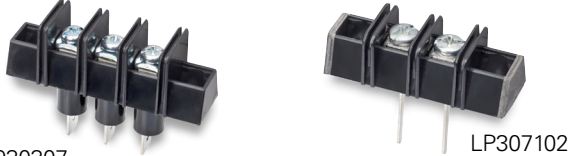

A31930307

LP307102

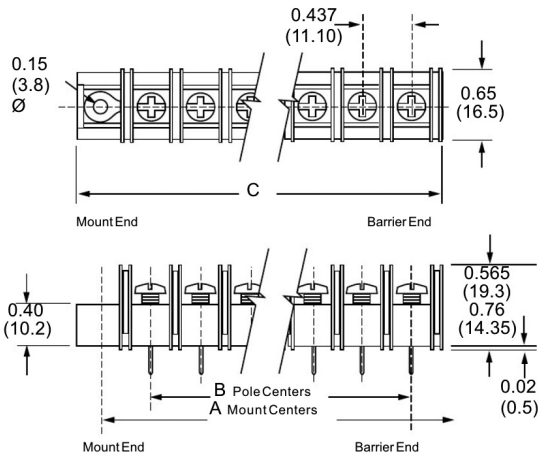

#### CB3

CB35110407MP

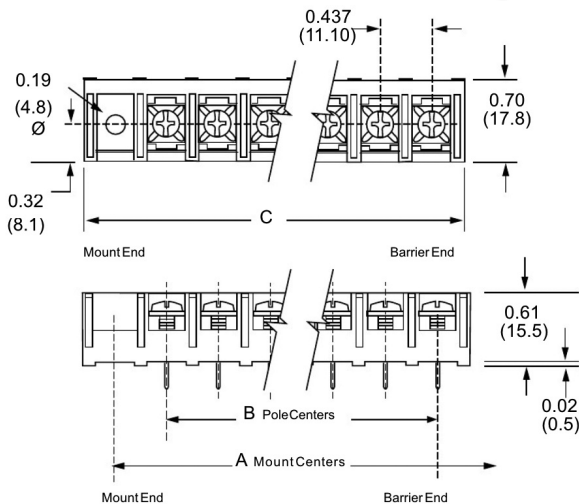

### Specifications

**Rating:** A3: 30A, 600V\* LP3: 30A, 150V\* CB3: 30A, 600V\*

**Wire Range:** #12-22 AWG Cu

**Center Spacing:** 0.437" or 7/16" (11.10mm)

**Screw Size:** #6-32 zinc-plated phillot screws.

**Torque Rating:** 9 lb-in.

**Base:** Standoffs standard for easy flux washing.

**Distance Between Barriers:** 0.32" (8.1mm)

**Recommended PCB Hole Diameter:** 0.076" (1.93mm)

**Operating Temperature:** 105°C (221°F) max., -40°C (-40°F) min.

**Molded Material:** Black, UL Rated 94V0 Thermoplastic

**Breakdown Voltage:** 3500V (A3 & LP3); 8200V (CB3)

**Agency Information:** UL File E62622, CSA 47235; IEC Compliance, CE Certified

\* 30A Rating achieved with a #10 copper wire crimped to a ring terminal; 20 Rating without ring terminal.

Poles	MOUNTING ENDS ONLY		BARRIER & MOUNTING ENDS	
	A Mounting Ctrs.	C Length	B Pole Ctrs.	C Length
02	1.31	1.73	0.43	0.98
03	1.75	2.17	0.87	1.43
04	2.18	2.61	1.31	1.87
05	2.62	3.05	1.75	2.31
06	3.06	3.48	2.18	2.75
07	3.50	3.92	2.62	3.18
08	3.93	4.36	3.06	3.62
09	4.37	4.80	3.50	4.06
10	4.81	5.23	3.93	4.50
11	5.25	5.67	4.37	4.93
12	5.68	6.11	4.81	5.37
13	6.12	6.55	5.25	5.81
14	6.56	6.98	5.68	6.25
15	7.00	7.42	6.12	6.68
16	7.43	7.86	6.56	7.12
17	7.87	8.30	7.00	7.56
18	8.31	8.73	7.43	8.00
19	8.75	9.17	7.87	8.43
20	9.18	9.60	8.31	8.87
21	9.62	10.05	8.50	9.31
22	10.06	10.48	9.18	9.75
23	10.50	10.92	9.62	10.18
24	10.93	11.36	10.06	10.62
25	11.37	11.80	10.50	11.06
26	11.81	12.23	10.98	11.50
27	-	-	11.81	12.37
28	-	-	11.37	11.07



Powering Business Worldwide

Eaton's single row terminal blocks may, on occasion, have various cosmetic variations on their ends due to machining operations that achieve the proper number of poles required. Cutting and machining blemishes are permissible and have no effect on the fit, form or function of the product.

## Part Numbering System

### Family

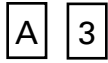

**A3** - standard barrier

### Terminal Style

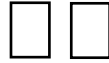

- 01** - handwired
- 02** - printed circuit
- 03** - non feed-thru
- 04** - wire wrap tail
- 05** - extended handwired
- 07** - extended pin
- 09** - 0.250 QC short
- 10** - 0.187 QC
- 19** - 0.250 QC long

### Base/End



- 1** - std. base/mount end
- 2** - std. base/barrier
- 3\*** - insulator base/mount end
- 4\*** - insulator base/barrier end
- 5\*\*** - closed base/mount end

### Poles

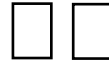

- 02 to 28** barrier end
- 02 to 26** mount end

### Screw Options

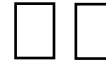

- Blank-std. screws
- 03** - stainless steel
- 04** - brass nickel-plated
- 07** - steel SEMS zinc-plated\*\*\*
- 09** - brass SEMS nickel-plated\*\*\*
- 07WR** - steel SEMS wire ready
- CA†** - captive screw

### Options

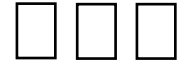

- AB** - angle mnt. options (pg 18)
- A1 to A9** - 0.250" QC
- B1 to B9** - 0.187" QC
- L1 to L6** marking options (pg 25)
- MP, MT** - mounting plates (pg 18)
- RC** - retaining clips (pg 18)
- R30 to R66** - right angle bends (pg 18)

\* Base/End Styles 3 and 4 not available with 02, 03, and 09 terminals.

\*\* Base/End Note: 5 Style only available with 03 terminals.

\*\*\* SEMS screws not available with hardware options

† Not compatible with 03 stainless steel screw option.

## Terminal Styles Inches (Millimeters)

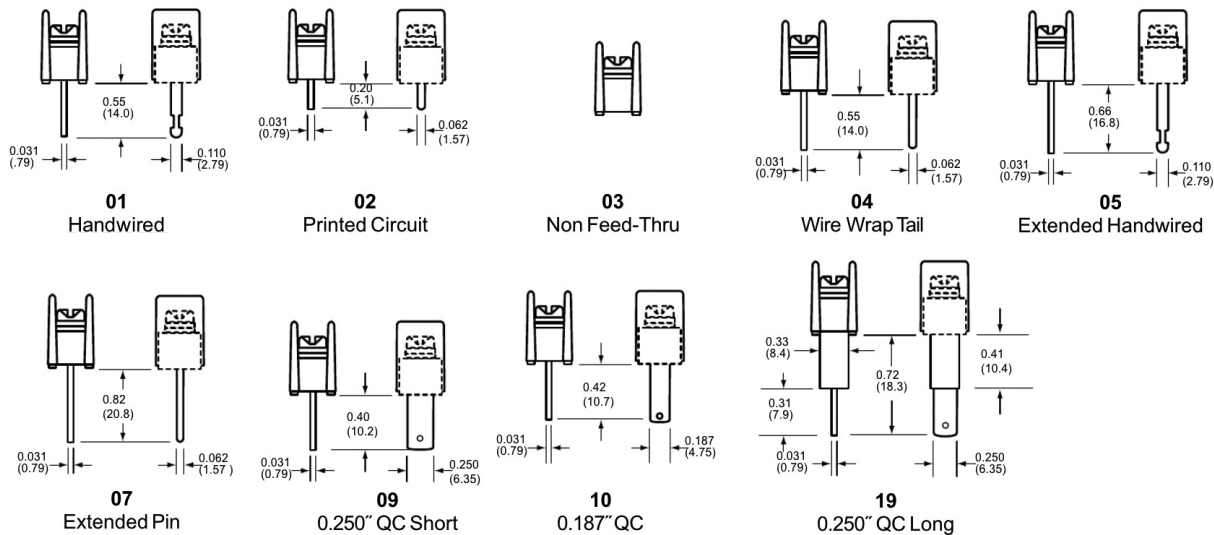

## Screw Options

(Bulk ordering part numbers are in parentheses)

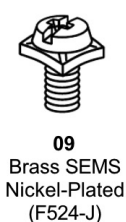
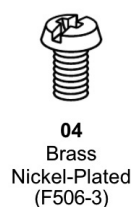

## Part Numbering System

Family	Terminal Style	Base/End	Poles	Screw Options	Options
<p><b>LP3</b> - low profile barrier</p>	<p><b>01</b> - handwired  <b>02</b> - printed circuit  <b>03</b> - non feed-thru  <b>04</b> - wire wrap tail  <b>05</b> - extended handwired  <b>07</b> - extended pin</p>	<p><b>1</b> - std. base/mount end  <b>2</b> - std. base/barrier  <b>3*</b> - insulator base/mount end  <b>4*</b> - insulator base/barrier end  <b>5**</b> - closed base/mount end</p>	<p><b>02 to 28</b> barrier end  <b>02 to 26</b> on mount end</p>	<p>Blank—std. screws  <b>00</b> - screws shipped  <b>04</b> - brass nickel-plated  <b>07</b> - steel SEMS zinc-plated***  <b>CA</b> - captive screw</p>	<p><b>A1 to A9</b> - 0.250" QC  <b>B1 to B9</b> - 0.187" QC  <b>L1 to L6</b> marking options (pg 25)  <b>MP</b> - mounting plates (pg 18)  <b>R30 to R66</b> - right angle bends (pg 18)</p>

\* A2 only.  
 \*\* Not compatible with 03-stainless steel screws.  
 \*\*\* SEMS screws not available with hardware options

## Terminal Styles Inches (Millimeters)

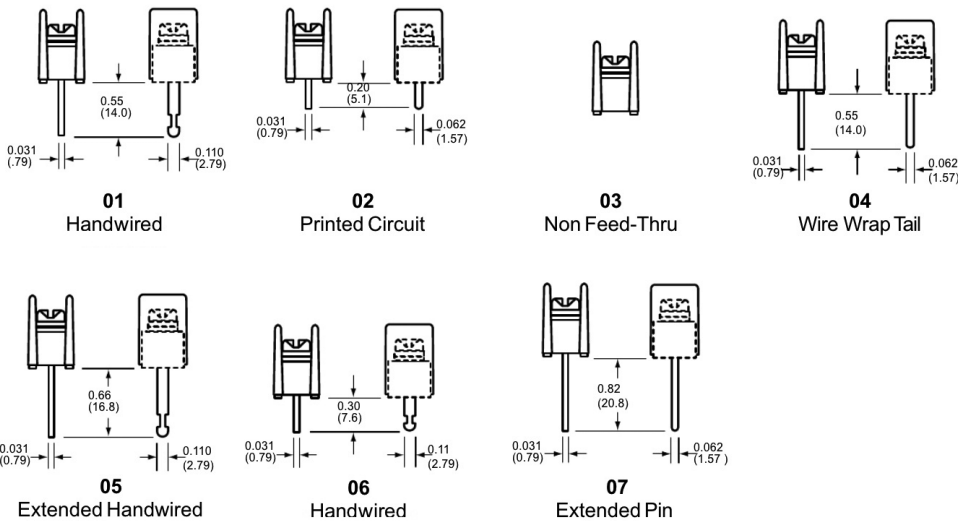

## Screw Options

(Bulk ordering part numbers are in parentheses)



**Standard**  
 Zinc-Plated Steel  
 (F505-J)



**04**  
 Brass  
 Nickel-Plated  
 (F506-J)



**07**  
 Steel SEMS  
 Zinc-Plated  
 (F523-J)

**Hardware Options** Inches (Millimeters)

(Bulk ordering part numbers are in parentheses)

**Jumpers**



†J201  
Flatslip-on  
(J201-J)



†OJ3  
(OJ3-J)



†OJ7  
LP3 Only  
(OJ7-J)



†OJ5  
(OJ5-J)

† Contact Eaton for desired configuration.

**Quick Connects** Blade Width A = 0.250" Blade Width B = 0.187"

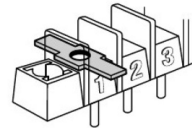

A1 & B1  
(2A1-J & 2B1-J)



A2 & B2  
(2A2-J & 2B2-J)

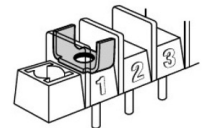

A3 & B3  
(2A3-J & 2B3-J)

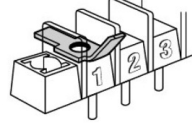

A4 & B4  
(2A4-J & 2B4-J)

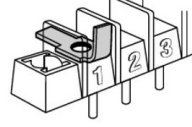

A5 & B5  
(2A5-J & 2B5-J)



A6 & B6  
(2A6-J & 2B6-J)

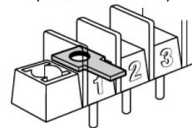

A7 & B7  
(2A7-J & 2B7-J)

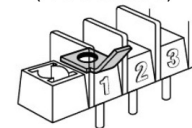

A8 & B8  
(2A8-J & 2B8-J)

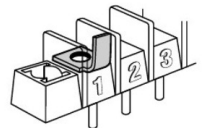

A9 & B9  
(2A9-J & 2B9-J)

**Base/End Options** Inches (Millimeters)



1 - Standard base/mount end



2 - Standard base/barrier end



3 - Insulator base/mount end

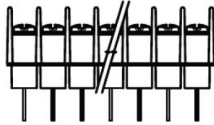
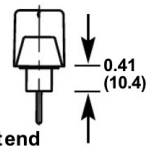

4 - Insulator base/barrier end

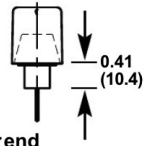

5 - Closed base/mount end



**Mount End Details**

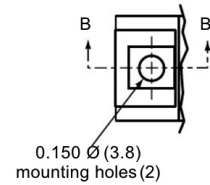

0.150 Ø (3.8)  
mounting holes (2)

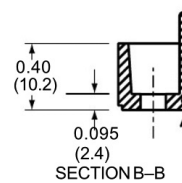

SECTION B-B

**1, 3 & 5 Mount End**

Note: On 1, 3 and 5 bases, Eaton may drill a terminal spacing to be a mount end. There will be no fit/form/function effect of mounting the product

**Mounting Options** Inches (Millimeters)

**Right Angle Mounting Bracket**

Right angle terminals are offered on the A3 & LP3. Configurations are defined in these dimensions: X = pin extension beyond the block base; Z = length from block base to centerline of the terminal tip. Standard bends consist of the X and Z dimensions shown in the chart. Specify by adding the selected Bend Option Code to the terminal part number.

**04 Terminal Bend Configurations**

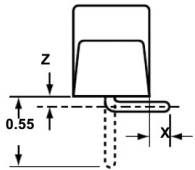

Bend Option Code	X (minimum)	Z	Available w/insulator base
R36	0.02	0.22	No
R42	0.08	0.16	No
R46	0.12	0.12	No
R50	0.16	0.08	No

Dimensions in inches. To convert to millimeters, multiply by 25.4.

**07 Terminal Bend Configurations**

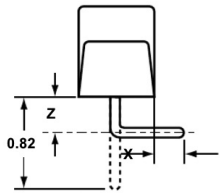

Bend Option Code	X (minimum)	Z	Available w/insulator base
R36	0.02	0.49	Yes
R50	0.16	0.35	No
R66	0.32	0.19	No

Dimensions in inches. To convert to millimeters, multiply by 25.4.

**Angle Brackets (A3 only)**

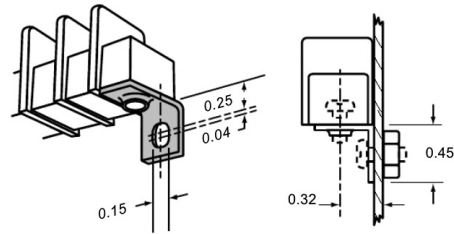

**Option AB**

Angle brackets enable block to be fastened at right angles to normal mount position. Bulk part number **2AB-J**.

**Mounting Plates**

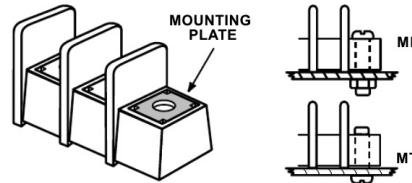

**Options MP & MT**

**MP** Metal inserts with 0.150" dia. hole accept #6 screw.

**MT** Metal inserts with tapped hole accept #6-32 screw.

Bulk part number **2MP-J, 2MT-J**.

**Retaining Clip**

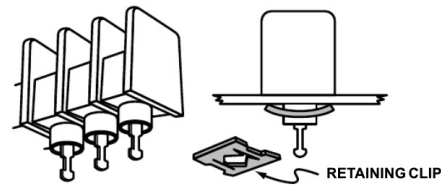

**Options RC**

Use on standoff tubes. Fit panels up to 0.125" thick. Two clips for every five positions. Supplied unassembled. Bulk part number **H541-J**.

## Part Numbering System

### Family



**CB3** - closed back

### Terminal Style

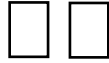

**01** - handwired  
#6-32 screw

**02** - printed circuit  
#6-32 screw

**07** - extended pin  
#6-32 screw

**51\*** - handwired  
#8-32 screw

**52\*** - printed circuit  
#8-32 screw

### Base/End



**1** - mount end

**2** - barrier end

### Poles



**02 to 22** barrier  
end

**02 to 20**  
on mount  
end

### Screw Options

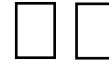

**07** - steel SEMS  
(standard)

**09** - brass SEMS  
nickel-plated

**CA** - SEMS captive

### Options



**A7 to A9** - 0.250" QC

**B7 to B9** - 0.187" QC

**EB** exit back terminals

**L1 to L6** marking options  
(pg 25)

**LT1 to LT6** marking options  
(pg 25)

**MP** mtg. plates (pg 20)

**Covers** - (pg 26)

\*Note: #8-32 screw is a special with #6-32 head.

## Terminal Styles Inches (Millimeters)

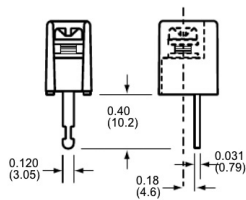

**01**

Handwired #6-32 screw

**51**

Handwired #8-32 screw

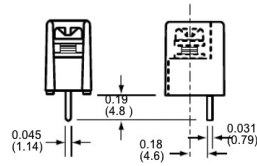

**02**

Printed Circuit #6-32 screw

**52**

Printed Circuit #8-32 screw

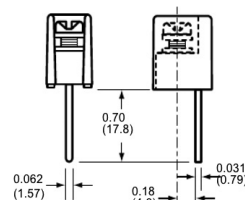

**07**

Extended Pin #6-32  
screw

## Screw Options

(Bulk ordering part numbers are in parentheses)



**07**

Steel SEMS  
Zinc-Plated  
(standard)  
(B001-7084-J)



**09**

Brass SEMS  
Nickel-Plated  
(F524-J)

## CB3 Terminal Exit Options Inches (Millimeters)

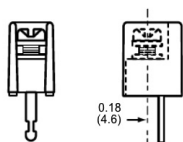

**Exit Rear (std.)**

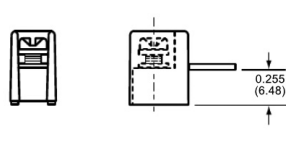

**EB**  
Exit Back

### Hardware Options

Inches (Millimeters)

(Bulk ordering part numbers are in parentheses)



†OJ3  
(OJ3-J)

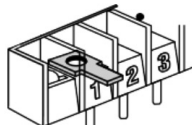

A7 & B7  
(2A7-J & 2B7-J)

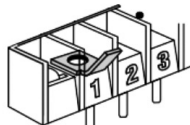

A8 & B8  
(2A8-J & 2B8-J)



A9 & B9  
(2A9-J & 2B9-J)



†OJ7  
(OJ7-J)

† Contact Eaton for desired configuration.

### Mounting Options Inches (Millimeters)

#### Mounting Plates

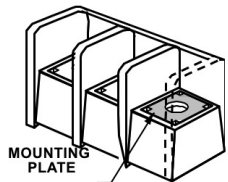

#### Options MP

MP Metal inserts with 0.150" dia. hole accept #6 screw.



## Single Row Terminal Blocks

# A38 & B38

### Dimensions Inches (Millimeters)

#### A38

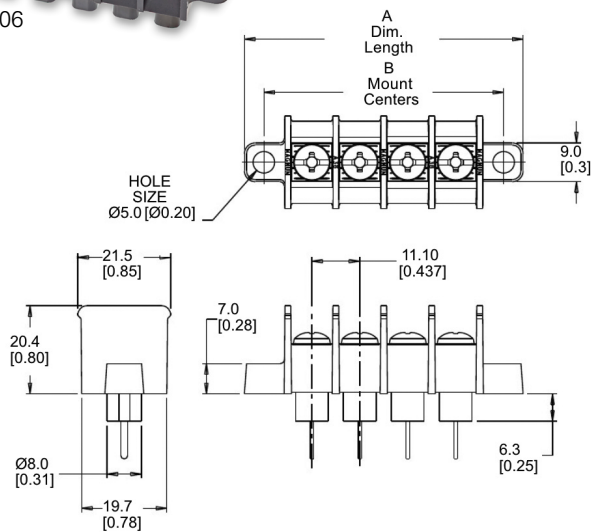

#### B38

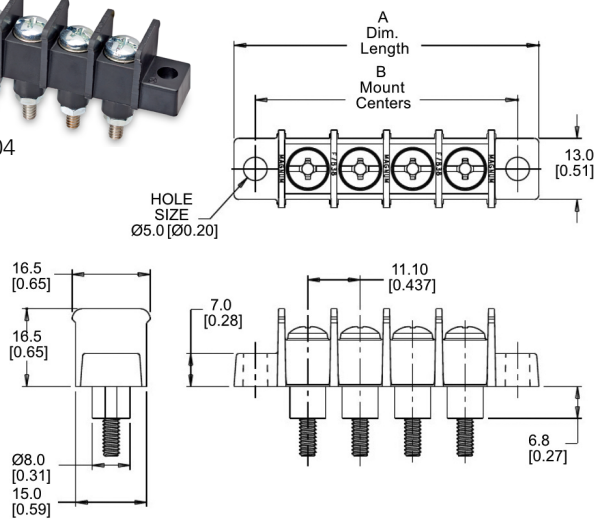

### Specifications

**A38:** 30A, 600V

**B38:** 50A, 300V

**Center Spacing:** 0.437" (11.10mm)

**Wire Range:** A38: #10-22 AWG Cu; B38: #8-16 AWG

**Screw Size:** #8-32 zinc-plated steel

**Torque Rating:** A38: 9 lb-in; B38: 15 lb-in for #8, 9 lb-in for #6

**Base:** A38 Only: Standoffs standard for easy flux washing

**Distance Between Barriers:** 0.378" (9.60mm)

**Recommended PCB Hole Diameter (A38):** 0.076" (1.93mm)

**Operating Temperature:** 105°C (221°F) max to -40°C (-40°F)

**Molded Material:** Black, UL Rated 94V0 Thermoplastic

**Breakdown Voltage:** 5000V

**Agency Information:** UL File E62622, CSA File 47235; CE Certified

Poles	MOUNTING ENDS ONLY		BARRIER ENDS ONLY
	A Mounting Centers	"A" Dimension Length	"A" Dimension Length
02	1.31	1.67	0.93
03	1.75	2.10	1.37
04	2.19	2.54	1.81
05	2.62	2.98	2.25
06	3.06	3.41	2.68
07	3.50	3.85	3.12
08	3.93	4.29	3.56
09	4.37	4.72	3.99
10	4.81	5.16	4.43
11	5.24	5.60	4.87
12	5.68	6.04	5.30
13	6.12	6.47	5.74
14	6.56	6.91	6.18
15	6.99	7.35	6.61
16	7.43	7.78	7.05

Dimensions in inches. To convert to millimeters, multiply by 25.4.



Powering Business Worldwide

### Part Numbering System

Family	Terminal Style	Base/End	Poles	Screw Options	Options
A 3 8					
	1 - handwired* 2 - printed circuit 7 - extended wire wrap 9 - 0.250" QC*	1 - flat base, mount end 2 - flat base, barrier end 3 - insulator base** mount end 4 - insulator base** barrier end		Blank - standard screw (steel zinc-plated, philslot BHMS) 04 - brass, nickel-plated, philslot BHMS 07 - steel, SEMS zinc-plated philslot screw	L1 to L6 marking options (pg 25) Covers - (pg 26)

Family	Terminal Style	Base/End	Poles	Screw Options	Options
B 3 8					
	3 - screw terminal (#6-32 screw top & bottom) 4 - stud (#8-32 screw top, #6-32 stud bottom) 5* - double stud (#6-32 stud top & bottom) <i>*C360 Copper Alloy (bright tin plate)</i>	4 - insulator base, barrier end 9 - insulator base, mount end		Blank - standard screw (steel zinc-plated, philslot BHMS) 34** - #6-32 nickel-plated brass philslot BHMS <i>**Note: 34 screws only available with "3" terminal style</i>	L1 to L6 marking options (pg 25) Covers - (pg 26)

### A38 Terminal Styles Inches (Millimeters)

Wire ready screws standard

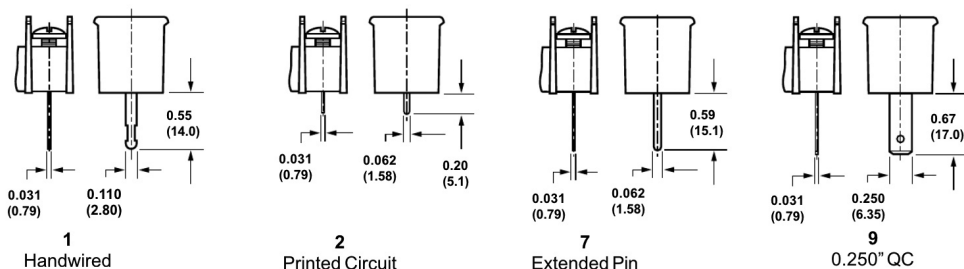

### B38 Terminal Styles

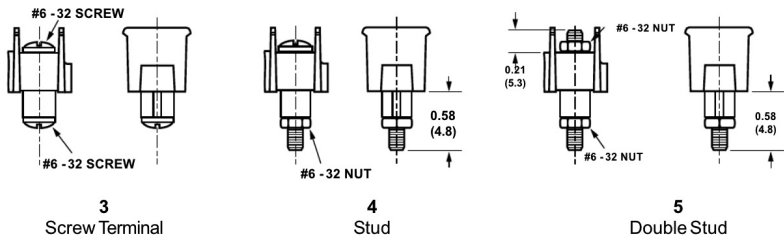

### Screw Options

(Bulk ordering part numbers are in parentheses)

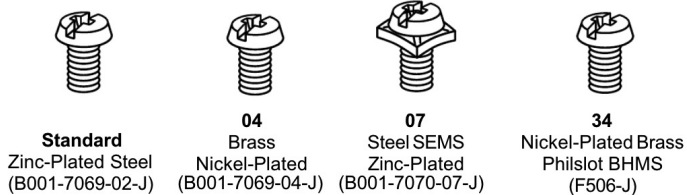

# Single Row Terminal Blocks

## A4 & B4

### A4

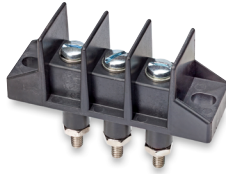

A400303

### B4



B484302

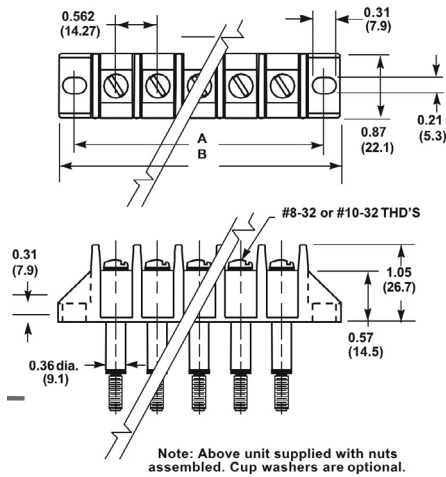

### Rating Table

Part Number	Terminal Top	Terminal Bottom	Wire* Range Cu	Rating* Volts/ Amps
A4003XX	# 8 Screw	#8 Stud	8-16 AWG	150V/50A
A4011XX	# 8 Screw	Solder	10-16 AWG	600V/35A
A4013XX	# 8 Screw	Solder	10-16 AWG	600V/35A
A4035XX	# 8 Screw	Closed	8-16 AWG	600V/50A
A4041XX	#10 Screw	Solder	10-16 AWG	600V/35A
A4043XX	#10 Screw	Solder	10-16 AWG	600V/35A
A4813XX	#10 Screw	Solder/Turret	10-16 AWG	600V/35A
A4843XX	#10 Screw	#8 Screw	8-16 AWG	150V/50A
A4953XX	#10 Stud	#10 Stud	8-16 AWG	150V/50A
B4843XX	#10 Screw	#8 Screw	8-16 AWG	600V/50A

\* All models 30A Max. with 10 AWG  
 35-50A ratings with 8 AWG using ring or fork type terminals.  
 Note: 50A rating achieved with #8 copper wire crimped to ring terminal.

### Specifications

**Rating:** See table.

**Center Spacing:** 0.562" or 9/16" (14.28mm)

**Wire Range:** See rating table.

**Screw Size:** #8-32 or #10-32 zinc-plated slotted screws

**Torque Rating:** #8 screw size 16 lb-in.

#10 screw size 20 lb-in.

**Distance Between Barriers:** 0.47" (11.9mm)

**Operating Temperature:** 105°C (221°F) max., -40°C (-40°F) min.

**Molded Material:** Black, UL Rated 94V0 Thermoplastic

**Hardware:** Bottom studs supplied with nuts assembled.

**Extended Hex Nuts:** Optional extended, slotted hex nuts enable easier installation and removal with hex wrench or screwdriver. Available in bulk for the #10-32 studs on A4953 blocks. Specify part number F582 and quantity.

**Breakdown Voltage:** 6100V

**Agency Information:** UL File E62622, CSA File 47235; CE Certified

### Dimensions Inches (Millimeters)



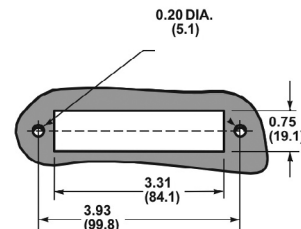

Poles	MOUNTING ENDS ONLY	
	"A" Mounting Centers	"B" Dimension Length
02	1.690	2.120
03	2.255	2.685
04	2.820	3.250
05	3.385	3.817
06	3.950	4.382
07	4.515	4.947
08	5.080	5.513
09	5.645	6.078
10	6.212	6.644
11	6.777	7.210
12	7.342	7.775
13	7.908	8.340
14	8.473	8.905
15	9.038	9.470
16	9.605	10.035

Dimensions in inches. To convert to millimeters, multiply by 25.4.

### Reference Panel Cutout for 6 Position Block

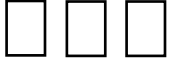

### Part Numbering System

Family	Terminal Style	Base/End	Poles	Screw Options	Options
 <b>A4</b> <b>B4</b>	 <b>00</b> - screw top; stud bottom <b>01</b> - screw top; solder bottom <b>03</b> - screw top only <b>04</b> - #10 screw top; solder term. b. <b>81</b> - screw top; solder turret bottom #10-32 <b>84</b> - screw top; screw bottom #10-32 <b>95</b> - stud top*, stud bottom	 <b>*1</b> - flat base/mount end  <b>3</b> - insulator base-(not available in 03 terminal style)/mount end  <b>5</b> - closed base/mount end (available in 03 terminal only)	 <b>02 to 16</b>	 <b>Blank</b> - std. screws <b>00</b> - screws shipped bulk <b>04</b> - brass nickel-plated† <b>07</b> - steel SEMS zinc plated (not available with hardware options; only available on A4011, A4013, A4021 and A4035)	 <b>A1 to A9</b> 0.250" QC <b>L1 to L6</b> marking options (pg 25) <b>Covers</b> - (pg 26)

\* Available in 01, 04 terminal styles only

### Terminal Styles Inches (Millimeters)

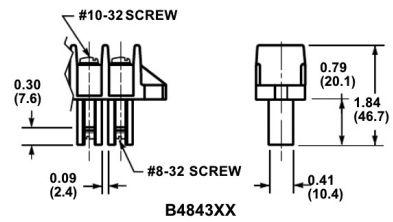
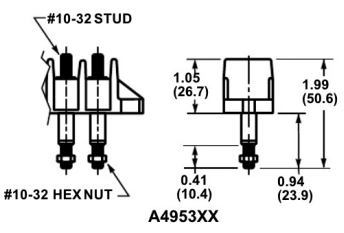
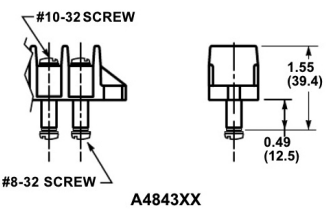
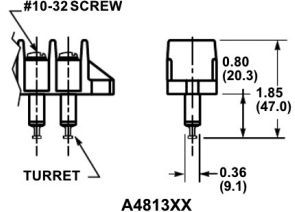
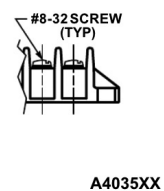
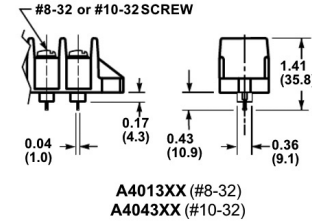
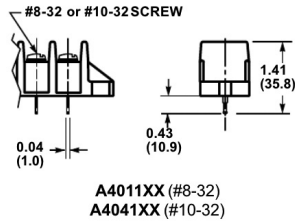
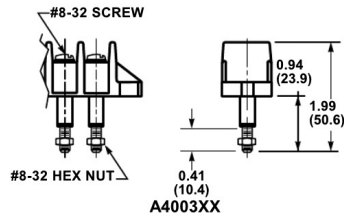

### Hardware Options Inches (Millimeters)

(Bulk ordering part numbers are in parentheses)

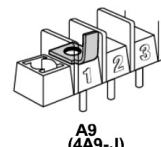
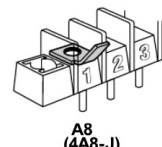
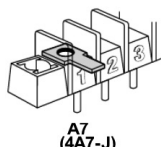
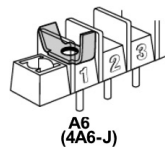
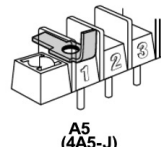
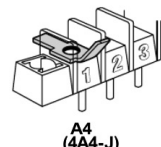
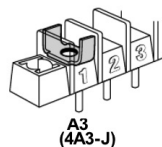
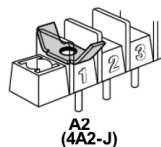
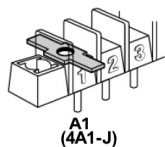
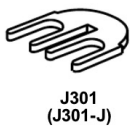

## Marking Options & Accessories

### Standard Marking

Markings are applied directly to the sides of A0, CB0, A1, CB11, A2, LP2, CB2, A3, LP3, CB3, A38, B38, A&B4. Standard characters are white and 1/8" high. Factory may substitute 3/32" high characters.

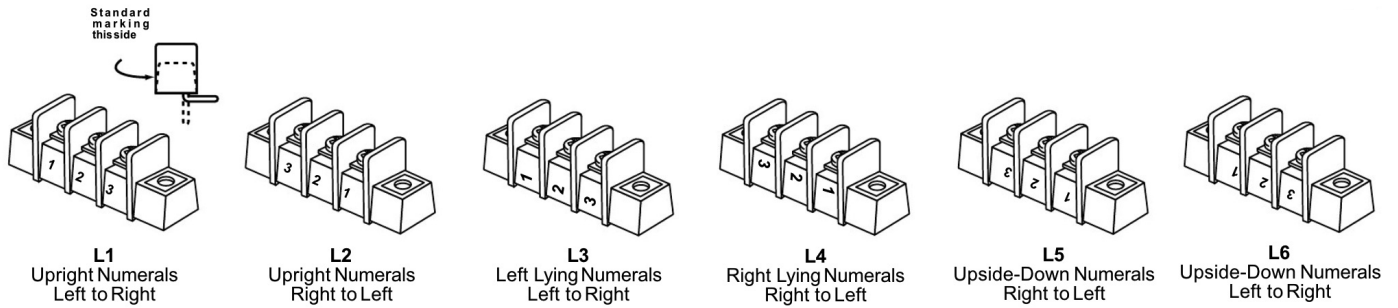

Blocks to be marked on both sides require a different code for each side. Example: "L1" on one side of the block requires "L2" on the other side to ensure common terminal marking. Specify by adding suffix to part number.

### Special Marking

Special markings are available upon request at an additional charge for preparation. Production charges for setup, handling and marking are the same as for standard marking and the same quantity discounts apply. Consult factory for price and delivery.

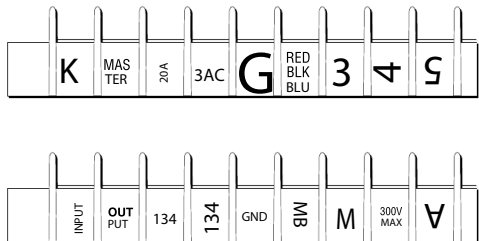

### Closed Barrier Terminal Block Marking Options for (CB11, CB2 and CB3)

- L1 & LT1 = Upright numerals, numbered from left to right
- L2 & LT2 = Upright numerals, numbered from right to left
- L3 = Left lying numerals, numbered from left to right
- L4 = Right lying numerals, numbered from right to left
- L5 & LT5 = Upside down numerals, numbered from right to left
- L6 & LT6 = Upside down numerals, numbered from left to right

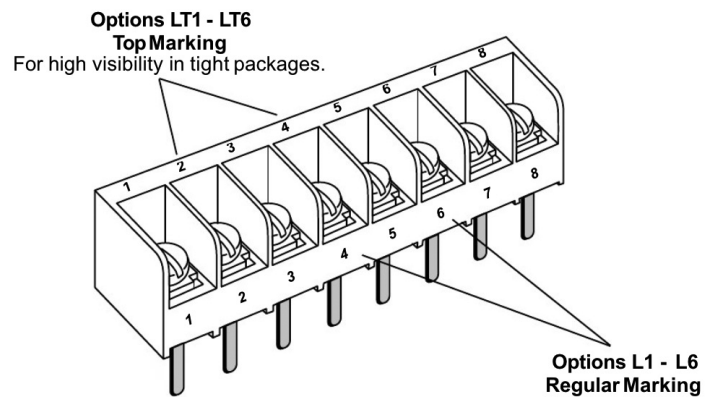

## Cover Options - Single Row

### Terminal Block Covers

Available for A2, A3, A4 & B4, LP2, & LP3 (mount ends only)

Three styles of UL 94V0 thermoplastic covers are offered in black. Covers are ordered separately and supplied with two clips each, unless ordered without clips. Optional markings may be specified (white on black).

Notes: Covers **cannot** be used with:

- mounting plate options MP & MT.
- certain quick connect terminals.
- 6 base/end styles on A2

Bulk Cover Clips: A2, A3, LP2 & LP3 Family = **CC2-J**;

A4 & B4 Family = **CC4-J**.

### Standard Cover Markings

Top Forward - TF

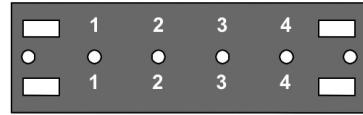

Bottom Forward - BF  
Skirted Access Side

Top Reverse - TR

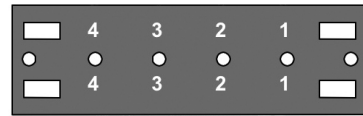

Bottom Reverse - BR  
Skirted Access Side



**Cover Options BB**  
Skirted access on both sides.

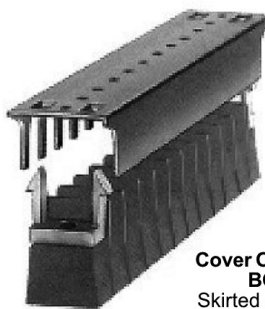

**Cover Options BO**  
Skirted access on one side only.

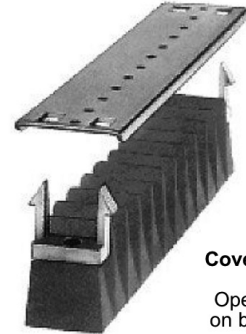

**Cover Options BC**  
Open access on both sides.

#### Cover



**BB** - skirted access, both sides, black

**BO** - skirted access, one side, black

**BC** - open access, both sides, black\*

\* Not available in 4000



**2** - A2, LP2

**3** - A3, LP3

**4** - A4, B4

#### Poles

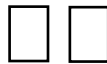

**02 to 36**

#### Markings (if desired)



**BF** - bottom forward

**TF** - top forward

**BR** - bottom reverse

**TR** - top reverse

#### Options



**00** - without clips

## Snap-On Covers for A38/B38/A0 & CB2/CB3

Can be used on both mount ends and barrier bases

### A38/B38/A0



### CB2/CB3



T A 8 - [ ] [ ] **A38**

T B 8 - [ ] [ ] **B38**

T A 0 - [ ] [ ] **A0**

#### Poles

T O 2 - [ ] [ ] **CB2**

T O 3 - [ ] [ ] **CB3**

Note: these are labeled as the letter "O" not a "zero"

## Tools & resources

- [Webpage](#)
- [Terminal block selector tool](#)
- [Terminal block cross reference](#)
- [Contact us](#)

**Eaton**  
**Electronics Division**  
1000 Eaton Boulevard  
Cleveland, OH 44122  
United States  
[Eaton.com/electronics](http://Eaton.com/electronics)

© 2021 Eaton  
All Rights Reserved  
Printed in USA  
Publication No. 10682  
June 2021

Eaton is a registered trademark.

All other trademarks are property  
of their respective owners.

Follow us on social media to get the  
latest product and support information.

