

GCC-2

**GEMexpress™ II
LCD Adapter Board**

**August 2019
Revision C**

DATA SHEET

Amulet

Introduction

It is a fast, inexpensive production solution for adding a graphic user interface to an embedded product. GEMexpress™ II allows for greater design flexibility and a shorter time to market.

This new hardware approach to GUI integration contains all of Amulet's bill of materials, which is everything needed to drive the user interface. It just needs to be attached to a simple display interface board and the human interface is ready for production.

As it's easy to integrate, Amulet sees it as the "express" lane to production: fast, easy and cost effective.

Compatible with GEMstudio™ for quick and easy GUI design, these production-ready units support GIF, JPEG, PNG, and more graphic formats in 24-bit color, plus 8-bit alpha blending (transparency channel) found in high-end consumer electronic products.

The GCC-2 has 256Mb (32Mx8) of SDR SDRAM for image caching , and 64Mb of serial data flash for code storage.

Amulet's Graphical OS Chip™ handles all the graphics processing and control as well as the communication to a host controller.

Features

Adapter Board

- Amulet GEM Graphical OS Chip™ with Royalty-free Graphical Operating System™
- Operating Temperature: -40°C to 85°C
- On-Board Memory - 64 Megabit serial flash for storing GUI pages
- 256Mb SDRAM for image frame buffer
- 24-bit color support
- Small and compact 1.5" x 3.0", fits within the outline of a 3.5" TFTs

Touch Panel

- Integrated 4-wire or 5-wire touchpanel decoder

Communication Interfaces

- 1x UART-TTL
- 1x SPI with 2 Chip Selects
- 1x TWI
- 2x PWM
- USB 2.0 Device Interface

Power

- 5V DC

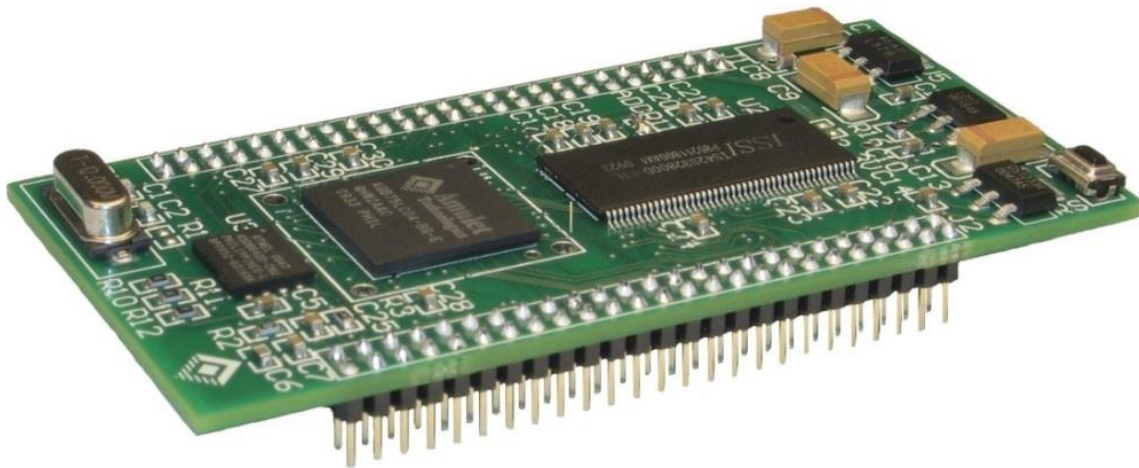

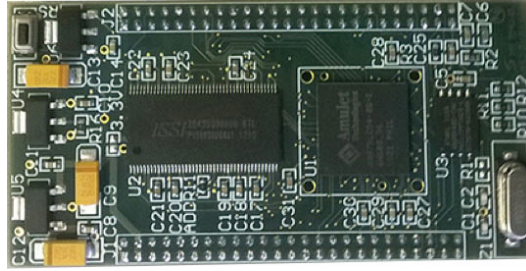

J1

2	4	6	8	10	••••	44	46	48	50
1	3	5	7	9		43	45	47	49

50 Pin I/O - J1					
Description	Signal	Pin Number		Signal	Description
5V @ 500mA	5V	1	2	5V	
3V @ 500mA Ouput	3V	3	4	3V	
Ground	GND	5	6	GND	Ground
No Connect	N/C	7	8	N/C	No Connect
No Connect	N/C	9	10	N/C	No Connect
No Connect	N/C	11	12	N/C	No Connect
Serial Data	TWI SDA	13	14	TWI SCLK	Serial Clock
Ground	GND	15	16	GND	Ground
Asynchronous Serial-Data Output	COMMU TXD	17	18	COMMU RXD	Asynchronous Serial-Data Input
Ground	GND	19	20	PWM2	Programmable Clock 2
Ground	GND	21	22	PWM1	Programmable Clock 1
Power Up Mode (1=Program, 0=Run) ¹	PMODE	23	24	PWM0	Programmable Clock 0
Touchpanel Calibrate (0=Normal, 1=Calibrate) ¹	TPC	25	26	GND	Ground
100K Programmable Pull-up	GPIO4	27	28	GPIO12	
	GPIO3	29	30	GPIO15	
	GPIO14	31	32	GPIO2	
Ground	GND	33	34	PROGU RXD	Asynchronous Serial-Data Input
Asynchronous Serial-Data Ouput	PROGU TXD	35	36	GND	Ground
Monitor for host detection	VBUS	37	38	DDP	USB Data +
Ground	GND	39	40	DDM	USB Data -
Ground	GND	41	42	SPI CS3	SPI Chip Select 3
SPI Chip Select 2	SPI CS2	43	44	SPI CS1	SPI Chip Select 1
SPI Clock	SCLK	45	46	MOSI	SPI Data Out
SPI Data In	MISO	47	48	GND	Ground
No Connect	N/C	49	50	/RESET	Active Low

Note 1: Internally Pulled Up.

J2

2	4	6	8	10	••••	44	46	48	50
1	3	5	7	9		43	45	47	49

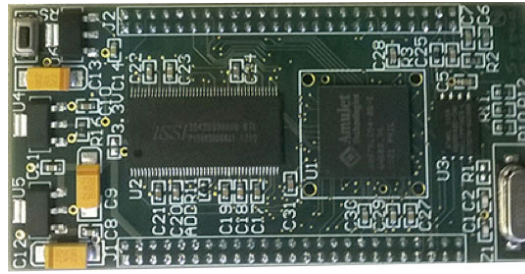

50 Pin I/O - J2					
Description	Signal	Pin Number		Signal	Description
Ground	GND	1	2	R0	LCD Pixel Data Red
LCD Pixel Data Red	R1	3	4	R2	LCD Pixel Data Red
LCD Pixel Data Red	R3	5	6	R4	LCD Pixel Data Red
LCD Pixel Data Red	R5	7	8	R6	LCD Pixel Data Red
LCD Pixel Data Red	R7	9	10	GND	Ground
LCD Pixel Data Green	G0	11	12	G1	LCD Pixel Data Green
LCD Pixel Data Green	G2	13	14	G3	LCD Pixel Data Green
LCD Pixel Data Green	G4	15	16	G5	LCD Pixel Data Green
LCD Pixel Data Green	G6	17	18	G7	LCD Pixel Data Green
Ground	GND	19	20	B0	LCD Pixel Data Blue
LCD Pixel Data Blue	B1	21	22	B2	LCD Pixel Data Blue
LCD Pixel Data Blue	B3	23	24	B4	LCD Pixel Data Blue
LCD Pixel Data Blue	B5	25	26	B6	LCD Pixel Data Blue
LCD Pixel Data Blue	B7	27	28	GND	Ground
Display Control Signal (1=ON, 0=OFF)	DISP	29	30	OE	Output Enable
TFT LCD First frame synchronization	VSYNC	31	32	HSYNC	
LCD Crystal Polarization Clock	PC	33	34	GND	Ground
Analog to Digital 6	A2D6	35	36	A2D5	Analog to Digital 5
Analog to Digital 4	A2D4	37	38	Touch X+	Touchpanel X+
Touchpanel Y+	Touch Y+	39	40	Touch X-	Touchpanel X-
Touchpanel Y-	Touch Y-	41	42	GND	Ground
SPI Chip Select 3	SPI CS3	43	44	SPI CS2	SPI Chip Select 2
SPI Chip Select 1	SPI CS1	45	46	SCLK	SPI Clock
SPI Data Out	MOSI	47	48	MISO	SPI Data In
Ground	GND	49	50	GND	Ground

Reference Circuits

Touchpanel Filter

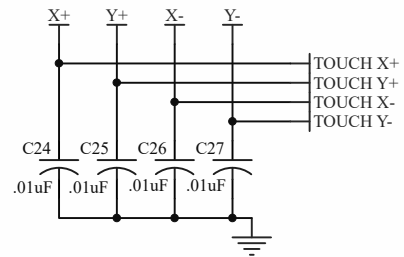

USB Interface

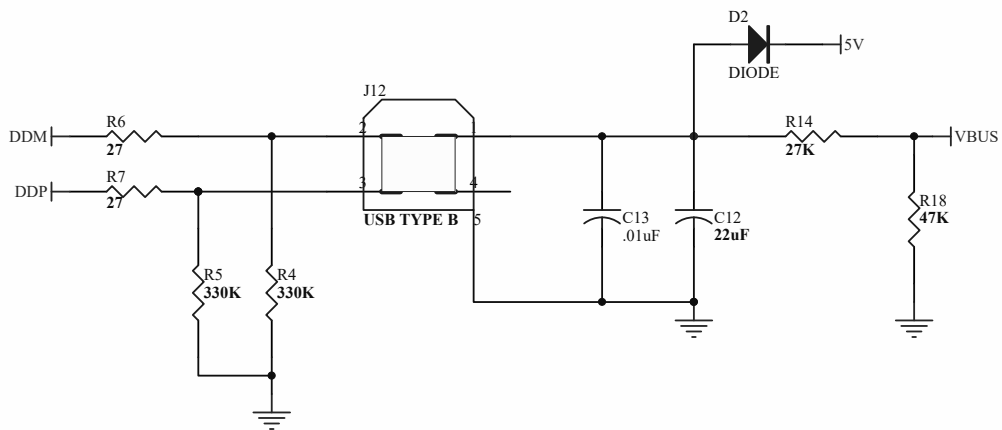

Backlight Circuit

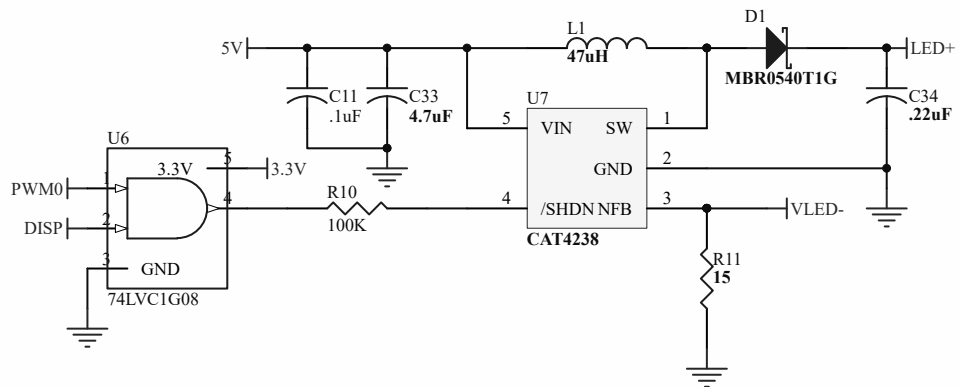

Mechanical Specification

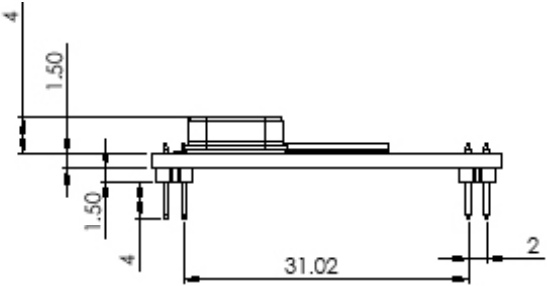
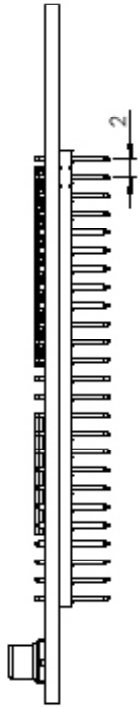
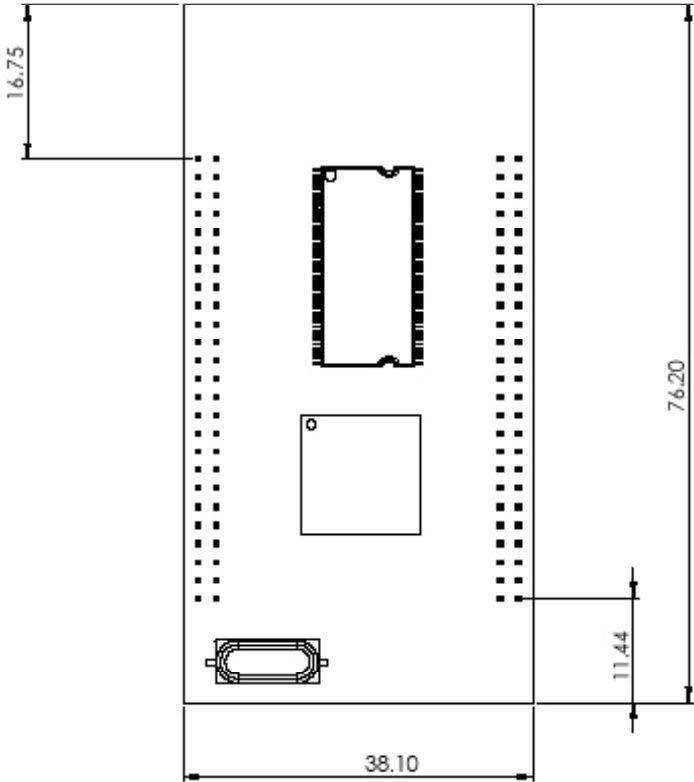

Recommended Operating Conditions

Parameter	Conditions	Min	Typ	Max	Units
Supply Voltage	Stable external supply required	4.5	5	5.5	Vdc

DC Characeristics

Parameter	Min
V core Supply Current	22mA @1.2V
V input Low Level	-0.3 to 0.8V
V input High Level	2V to (Vcc + 0.3V)
Pull Up Resistors	70K to 175KOhms
IO Output Current	8mA
Static Current Excluding Power on Reset V core = 1.2V	600uA
Static Current Logic cells consumption, including Power on Reset and all input drivers V core = 1.2V	30uA

Environmental Specification

Parameter	Min	Typ	Max	Units
Storage Temp	-30		80	°C
Operating Temp	-20		70	°C

Revision History

Date	Revision	Notes
13 July 2015	A	Publication
12 October 2015	B	Format change. Environment Specification added
19 August 2019	C	Logo change.



Contact Us:

You have Embedded GUI Questions. We have Answers.

Amulet Technologies Headquarters
1475 S. Bascom Ave., Suite 111
Campbell, CA 95008
USA
Phone: (408) 374-4956
Fax: (408) 374-4941
Email: info@amulettechnologies.com

Sales and Customer Support:
Phone: (888) 374-8688
Sales Email: sales@amulettechnologies.com
Support Email: support@amulettechnologies.com

Developer Support: devSupport@amulettechnologies.com

Disclaimer: The information in this document is provided in connection with Amulet Technologies, LLC (Amulet) products. No license, express or implied, to any intellectual property right is granted by this document or in connection with the sale of Amulet products. EXCEPT AS SET FORTH IN AMULET'S TERMS AND CONDITIONS OF SALE WHERE AMULET IS THE SELLER, AMULET ASSUMES NO LIABILITY WHATSOEVER AND DISCLAIMS ANY EXPRESS, IMPLIED OR STATUTORY WARRANTY RELATING TO ITS PRODUCTS INCLUDING, BUT NOT LIMITED TO, THE IMPLIED WARRANTY OF MERCHANTABILITY, FITNESS FOR A PARTICULAR PURPOSE, OR NON-INFRINGEMENT. IN NO EVENT SHALL AMULET BE LIABLE FOR ANY DIRECT, INDIRECT, CONSEQUENTIAL, PUNITIVE, SPECIAL OR INCIDENTAL DAMAGES (INCLUDING, WITHOUT LIMITATION, DAMAGES FOR LOSS AND PROFITS, BUSINESS INTERRUPTION, OR LOSS OF INFORMATION) ARISING OUT OF THE USE OR INABILITY TO USE THIS DOCUMENT, EVEN IF AMULET HAS BEEN ADVISED OF THE POSSIBILITY OF SUCH DAMAGES. Amulet makes no representations or warranties with respect to the accuracy or completeness of the contents of this document and reserves the right to make changes to specifications and product descriptions at any time without notice. Amulet does not make any commitment to update the information contained herein. Unless specifically provided otherwise, Amulet products are not approved for use in automotive applications, medical applications (including, but not limited to, life support systems and other medical equipment), avionics, nuclear applications, or other high-risk applications (e.g., applications that, if they fail, can be reasonably expected to result in significant personal injury or death).