

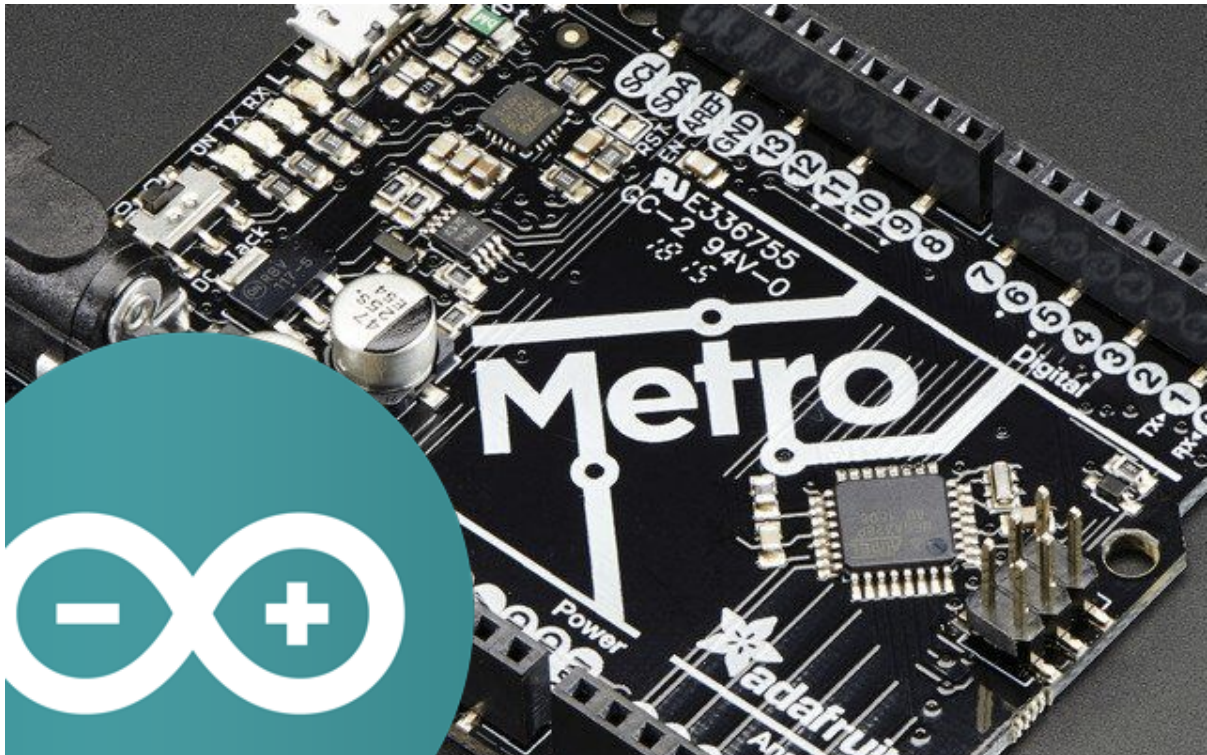

Experimenter's Guide for Metro

Created by Brent Rubell



<https://learn.adafruit.com/experimenters-guide-for-metro>

Last updated on 2022-12-01 02:57:33 PM EST

Table of Contents

Intro	13
<ul style="list-style-type: none">• Want to learn about the programming in Arduino but don't know where to start?• Start with the Experimenters Guide for Metro!• About The Experimenters Guides	
Electronics Primer	14
<ul style="list-style-type: none">• Identifying Resistors by Color Code• Lead Clipping• Identifying: TMP36 and NPN• Parts Field Guide	
Programming Primer	31
<ul style="list-style-type: none">• About Arduino Programming• The Arduino IDE• Structure• void setup() { }• void loop() { }• Syntax• // (single line comment)• /* */ (multi-line comment)• { } (curly brackets)• ; (the semicolon)• Variables• int (integer)• long• bool (boolean)• float• char (character)• Math• = (equals)• % (modulo)• + (addition)• - (subtraction)• * (multiplication)• / (division)• Control Flow• If Conditions• for() Loops• Digital Input/Output• pinMode(pin, mode)• digitalWrite(pin, value)• digitalRead(pin)• Analog Input/Output• analogWrite(pin, value)• analogRead(pin)	
Downloads	40
<ul style="list-style-type: none">• Fritzing Diagrams• Code	
What Board Do I Have?	40
<ul style="list-style-type: none">• I have a Metro	

- I have a Metro Express

Setting up your Metro 41

- USB Micro Cable
- Power your Metro!
- Arduino Bootloader Check.
- Download the Arduino Software

Windows Setup 44

- Downloading for Windows
- (Windows) Installing Arduino
- (Windows) Installing Drivers
- (Windows) Find your Serial COM Port

Mac Setup 52

- Downloading for macOS or OS X
- (macOS/OS X) Installing Arduino
- (macOS/OS X) Find your Serial Port
- (macOS / OS X) Installing Drivers
- Verifying macOS / OS X Drivers

Linux Setup 56

- Downloading for Linux
- (Linux) Installing Arduino
- (Linux) Installing Drivers
- (Linux) Find your Serial Port

Configure Arduino for the Metro Express 60

- Metro Express Arduino IDE Setup
- Using the Metro Express with Arduino IDE
- Install SAMD Support
- Install Adafruit SAMD

CIRC01: Blinking LED 67

- What We're Doing

Parts 68

- Let's begin by gathering our parts:

Wiring 69

- Breadboard Layout
- Steps
- Breadboard Layout Sheet

Code 71

- Blink
- Having issues with CIRC01?

Make It Better 74

- Congrats on building your first circuit with the Adafruit Metro!
- Change the pin
- Change the Blink time
- Control the brightness
- Fading

CIRC02: 8 LED Fun	75
<ul style="list-style-type: none">• What We're Doing	
Parts	76
Wiring	77
<ul style="list-style-type: none">• Breadboard Layout• Steps	
Code	78
<ul style="list-style-type: none">• Compile and Upload• Not Working? CIRC02 not matching the GIF?	
Make It Better	83
<ul style="list-style-type: none">• Switching to Loops• Extra Animations• Make your own animations	
CIRC03: Spin Motor Spin	85
<ul style="list-style-type: none">• What We're Doing	
Parts	86
Wiring	87
<ul style="list-style-type: none">• Steps	
Code	89
<ul style="list-style-type: none">• Having Trouble with CIRC03?	
Make It Better	91
<ul style="list-style-type: none">• Controlling Speed• Accelerating and Decelerating	
CIRC04: A Single Servo	92
Parts	93
Wiring	95
<ul style="list-style-type: none">• Connection details:• Breadboard Layout Sheet	
Code	96
<ul style="list-style-type: none">• Sweep• Not Working?	
Make It Better	98
<ul style="list-style-type: none">• Potentiometer Control• Wiring the Potentiometer• Metro Breadboard Diagram• Loading the example code• Self-Timing• Other fun servo ideas	
CIRC05: 8 More LEDs	102

Parts	103
Wiring	105
<ul style="list-style-type: none">• Chip Orientation• Step 1: Connect Power/GND• Step 2: Connect Data Pins to the Metro• Step 3: Connect the LEDs• Breadboard Layout Sheet	
Code	110
<ul style="list-style-type: none">• Not Working?	
Make It Better	113
<ul style="list-style-type: none">• Doing it the Hard Way• Controlling Individual LEDs• More Animations	
CIRC06: Music with Piezo	114
Parts	115
Wiring	116
<ul style="list-style-type: none">• Breadboard Layout Sheet	
Code	117
<ul style="list-style-type: none">• Not Working?	
Make It Better	118
<ul style="list-style-type: none">• Playing with Speed• Tuning the Notes• Composing your own Melodies:	
CIRC07: Button Pressing	120
Parts	120
Wiring	123
<ul style="list-style-type: none">• Breadboard Layout Sheet	
Code	124
<ul style="list-style-type: none">• Code:• Not Working?	
Make It Better	125
<ul style="list-style-type: none">• Light Switch• Fading• Changing Fade Speed	
CIRC08: Twisting	127
Parts	128
Wiring	130
<ul style="list-style-type: none">• Printable Breadboard Sheet	

Wiring for Metro Express	131
Code	131
• Not Working?	
Using the Arduino Serial Plotter	133
Make It Better	135
• Threshold Switching	
• Fading	
• Controlling the servo	
CIRC09: Light	137
Parts	138
Wiring	140
• Printable Breadboard Layout Sheet	
Wiring for Metro Express	140
Code	141
• Not Working?	
Make It Better	142
• Reverse the Response	
• Night Light	
• Light Controlled Servo	
• Using the full range of your servo	
• Learn More!	
CIRC10: Temperature	144
Parts	144
• Am I using a NPN Transistor or a TMP36 Temperature Sensor?	
Wiring	145
• Printable Breadboard Sheet	
Wiring for Metro Express	147
Code	147
• Using the Arduino Serial Monitor	
• Not Working?	
Make It Better	149
• Outputting Voltage	
• Outputting degrees Fahrenheit	
• More informative output	
• Changing the serial speed	
CIRC10.5: Temperature Alarm	151
• Add a Piezo!	

CIRC11: Larger Loads with Relays	154
Parts	155
<ul style="list-style-type: none">• Am I using a NPN Transistor or a TMP36 Temperature Sensor?	
Wiring	158
<ul style="list-style-type: none">• Wire it up:• Close-up of the relay wiring• Printable Breadboard Layout Sheet	
Code	159
<ul style="list-style-type: none">• Not Working?	
Make It Better	160
<ul style="list-style-type: none">• Check out the Back-EMF Pulse• Controlling a Motor• Controlling Motor Direction• Schematic Layout• Breadboard Layout	
CIRC12: Colorful Light	163
Parts	163
Wiring	165
<ul style="list-style-type: none">• Wire according to the diagram below:• Printable Breadboard Layout Sheet	
Wiring for Metro Express	165
Code	166
<ul style="list-style-type: none">• Having Trouble?	
Make It Better	168
<ul style="list-style-type: none">• More Colors• Display a Random Color• Analog Color Control	
CIRC13: Squeezing	170
Parts	171
Wiring	173
<ul style="list-style-type: none">• Printable Breadboard Layout Sheet	
Code	174
<ul style="list-style-type: none">• Not Working?	
Make It Better	175
<ul style="list-style-type: none">• Calibrating the Range• The RGB Strongperson Test• Other Applications	
CIRC14: Character LCDs	178

Parts	179
Wiring	180
<ul style="list-style-type: none">• Assembling your LCD• Soldering your LCD• Wiring Power and Backlight• Wiring the Contrast Circuit• Wiring the Data Bus	
Code	188
<ul style="list-style-type: none">• Not Working?	
Make It Better	190
<ul style="list-style-type: none">• Writing to the second line• Writing the light sensor to the LCD• Wiring• Code• What's next?	
CIRC15: Thermometer	192
Parts	193
<ul style="list-style-type: none">• Am I using a TMP36 Temperature Sensor or a NPN Transistor	
Wiring	195
Code	195
<ul style="list-style-type: none">• Code:• Having Trouble?	
Make It Better	197
<ul style="list-style-type: none">• Using Fahrenheit• Printing new text to the LCD• Printing to the Second Row• Using Custom Characters• Making your own Custom Character	
CIRC16: IR Sensor	200
Parts	201
<ul style="list-style-type: none">• IR (Infrared) Receiver Sensor• Mini Remote Control	
Wiring	203
Installing the IR Library	204
<ul style="list-style-type: none">• Installing Arduino Libraries• Installing the IR Library	
Code	204
<ul style="list-style-type: none">• Not Working?	
CIRC17: IR Replay	206

Parts	207
<ul style="list-style-type: none">• IR (Infrared) Receiver Sensor• Super-bright 5mm IR LED• Am I using a NPN Transistor or a TMP36 Temperature Sensor• Mini Remote Control (OPTIONAL)	
Wiring	211
Code	211
<ul style="list-style-type: none">• Not Working?	
Parts	214
Wiring for Metro Express	215
Code	215
<ul style="list-style-type: none">• Installing the NeoPixel Library• Code• Having trouble?	
Make It Better	218
<ul style="list-style-type: none">• Dimming the NeoPixel• NeoPixel Glance Thermometer• Wiring• Code• Adding the NeoPixel to CIRCs	
Parts	221
Wiring	222
Code	223
<ul style="list-style-type: none">• Using USB Blog Buddy• Not Working?	
Parts	225
<ul style="list-style-type: none">• If you're using a Metro Classic:• If you're using a Metro M0 Express:	
Wiring	226
<ul style="list-style-type: none">• Wiring for the Metro Classic• Wiring for the Metro Express	
Wiring for Metro Express	227
Code	228
<ul style="list-style-type: none">• Code• I'm having problems with this CIRC	
Make It Better	230
<ul style="list-style-type: none">• Using Different Input Types• Adding Sensor Inputs	
PROJ01: Theremin	231

Parts	232
Wiring	234
Wiring for Metro Express	234
Code	235
<ul style="list-style-type: none">• Setting Pins• Reading the photo light sensor• Creating the Pitch• Playing the Pitch• Wait...my PROJect doesn't work!	
Make It Better	237
<ul style="list-style-type: none">• Modifying the pitch• Stop the Music!	
PROJ02: MetroPOV Display	238
Parts	239
Wiring	240
Code	241
<ul style="list-style-type: none">• I need help	
Using MetroPOV	247
<ul style="list-style-type: none">• Taking Photos• GIF'ing your MetroPOV Text• Light Painting with MetroPOV	
PROJ03: Music Box	248
Parts	249
Wiring	251
<ul style="list-style-type: none">• Diagram• Assembly	
Code	253
<ul style="list-style-type: none">• Calibrating the Music Box• Encountering Problems?	
Make It Better	255
<ul style="list-style-type: none">• Music Composer• Unconventional Enclosures• Annoy-a-Box• Secret Message Box	
PROJ04: Fidget Spinner Tachometer	256
Parts	258

Wiring	260
<ul style="list-style-type: none">• Diagram• Assembly Tips	
Code	262
<ul style="list-style-type: none">• Not Working?	
Parts	266
<ul style="list-style-type: none">• IR Sensor• Mini Remote Control• Mini-USB Cable	
Wiring	267
Code	268
<ul style="list-style-type: none">• I'm having trouble with this Project	
Make It Better	272
PROJ06: IR Laser Pet Toy	273
Parts	274
Wiring	275
Assembly	276
<ul style="list-style-type: none">• Servo Wiring• Base Assembly	
Code	278
<ul style="list-style-type: none">• This project isn't working properly	
PROJ08: Analog Thermometer Gauge	283
Parts	284
Wiring	285
Assembly	286
<ul style="list-style-type: none">• Dialing in your Servo• Assembling an enclosure	
Code	290
<ul style="list-style-type: none">• Code	
Code	292

Intro

Want to learn about the programming in Arduino but don't know where to start?

You have come to the right place :)

Start with the Experimenters Guide for Metro!

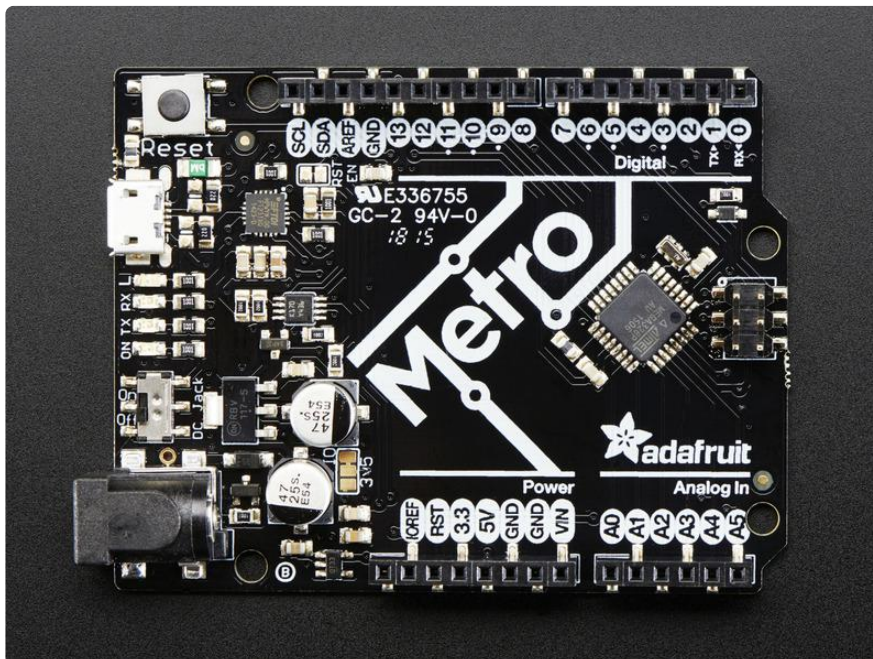

The Experimenters Guide for the Adafruit Metro and Metro Express is meant to serve as a quick-start for makers, artists, hackers, students, educators, or anyone who wants to get started with the Metro or Metro M0 Express.

This guide has lots of circuits to get you comfortable with skills like learning about different types of electronic components (and how they work), programming an Adafruit Metro or Metro Express, breadboarding, and modifying code.

Already have parts and a board that can be programmed by the Arduino IDE? This guide will work for you too!

As you progress through this guide in order, you'll be comfortable with the Adafruit Metro enough to work on your own projects (or at least enough to try one of the thousands of projects in the Adafruit Learning System)

About The Experimenters Guides

The experimenters guide is an expanded version of Oomlout's awesome [ARDX kit \(\)](#), but it's compatible the Adafruit Metro Classic and Metro M0 Express. There are a lot of new circuits to take advantage of the Metro Classic and/or Express, and a bunch of small projects to do on your own.

These guides were designed for use both with the 'classic' Metro (ATmega328) or Metro M0 Express (ATSAMD21) based Metros

You can build all of the circuits with parts from the Adafruit Shop. We even provide links to the parts for each circuit in the parts page.

Electronics Primer

No previous electronic experience is required to have fun with this kit. Here are a few details about each component to make identifying, and perhaps understanding them, a bit easier. If at any point you are worried about how a component is used or why it's not working the internet offers a treasure trove of advice, or [you can get help on our community support forums \(\)](#)

Identifying Resistors by Color Code

The graphic above is super useful for the Explorers guide - most CIRCs use them. Resistors have different values, consult this graphic if you get stuck later. If you want to get really good at identifying resistors quickly, play our fun iOS Game: [Mho's Resistance \(\)](#)

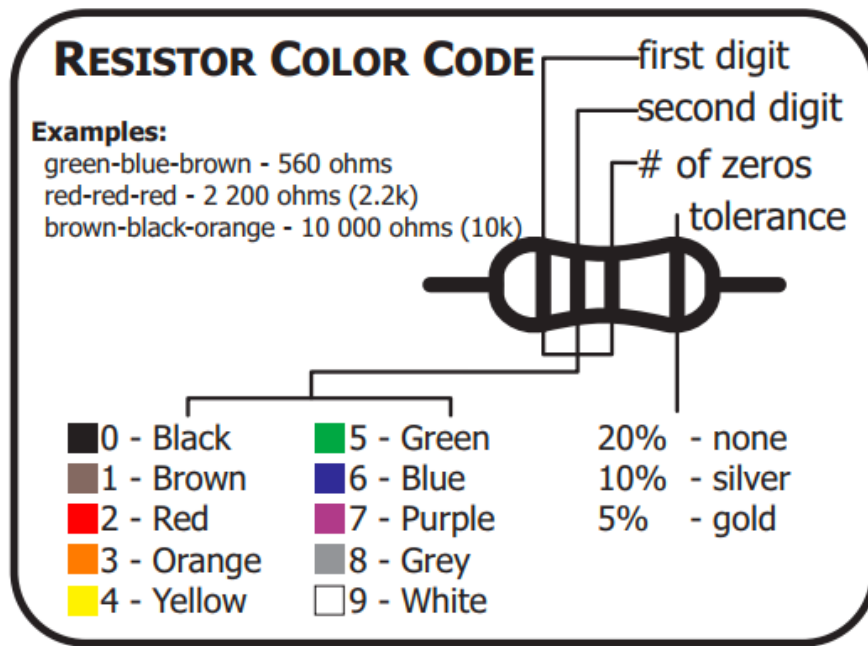

Lead Clipping

Some components in this kit come with very long wire leads. To make them more compatible with a breadboard a couple of changes can be made.

LEDs:

Clip the leads so the long lead is ~10mm (3/8") long and the short one is ~7mm (9/32"). If you don't own clippers, [you can pick up the CHP17 Flush Diagonal Cutters in the Adafruit shop \(\)](#)

Resistors:

Bend the leads down so they are 90 degrees to the cylinder. You can do this precisely with [Pliers \(\)](#) or bending it against a 90 degree desk corner.

Then snip them so they are ~6mm (1/4") long.

Other Components:

Other components may need clipping. Use your discretion when doing so.

Identifying: TMP36 and NPN

While the TMP36 Analog Temperature Sensor and the NPN Transistor are similar, they perform very different tasks. To avoid mixing them up in your circuit, use these two pictures to identify which part you have:

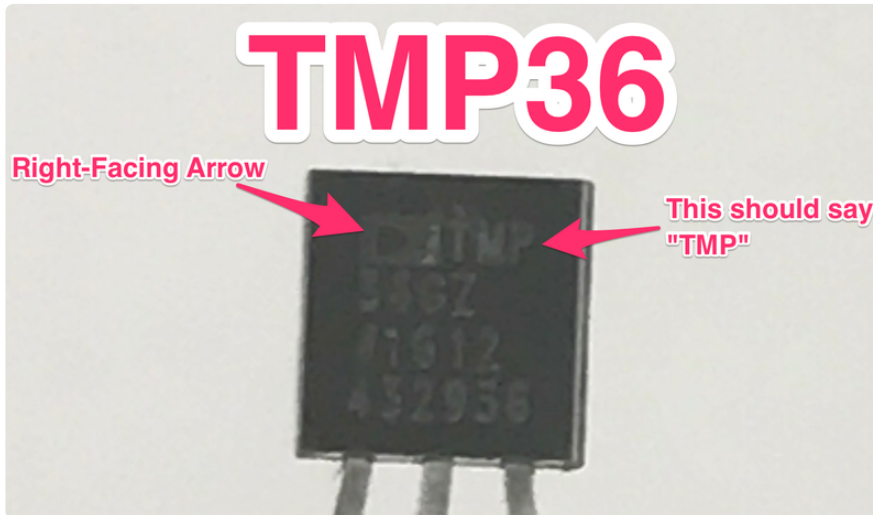

Parts Field Guide

(all of these parts can be found in the Metro Experimenters kit, click the image to enlarge it)

Part Picture	Name & What does it do?	How to Identify	No. of Leads
	LED: Emits light when a small current is passed through it. (only in one direction)	Looks like a mini light bulb.	2 (or 3)



Diode: The electronic equivalent of a one way valve. Allowing current to flow in one direction but not the other.

Usually a cylinder with wires extending from either end. (and an off center line indicating polarity)

2

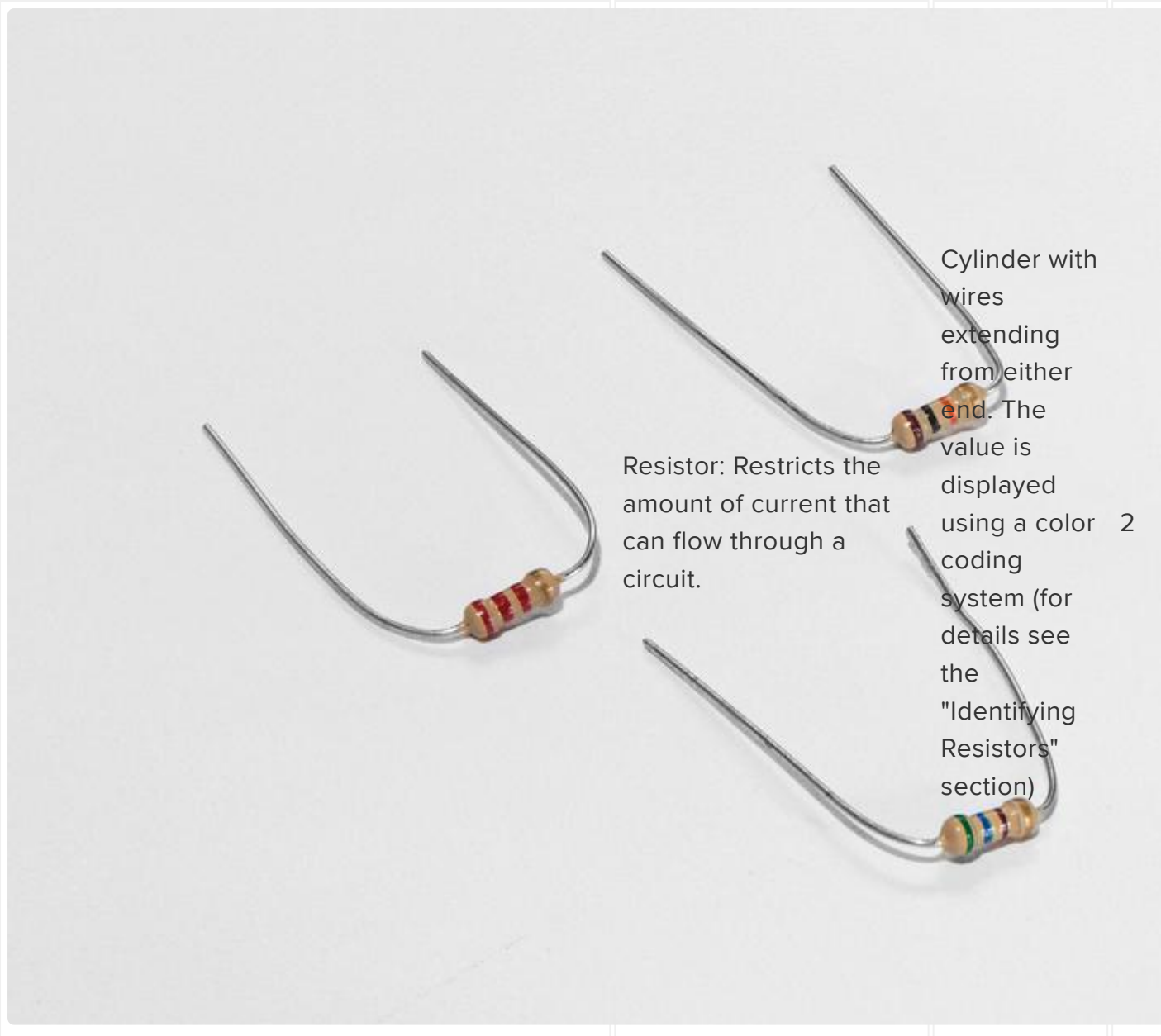

Resistor: Restricts the amount of current that can flow through a circuit.

Cylinder with wires extending from either end. The value is displayed using a color coding system (for details see the "Identifying Resistors" section)



Transistor: Uses a small current to switch or amplify a much larger current.

Comes in many different packages but you can read the part number off the package (P2N2222AG in this kit) and find a datasheet online.

3 (Ba
Colle
Emit



a timed pulse and converts it into an angular position of the output shaft

A plastic box with 3 wires coming out one side and a shaft with a plastic horn out the top.

3



DC Motor: Spins when a current is passed through it.

This one is easy, it looks like a motor. Usually a cylinder with a shaft coming out of one end.

2



zo: A pulse of current will cause it to click. A stream of pulses will cause it to emit a tone.

In this kit it comes in a little black barrel, but sometimes they are just a gold disk.

2

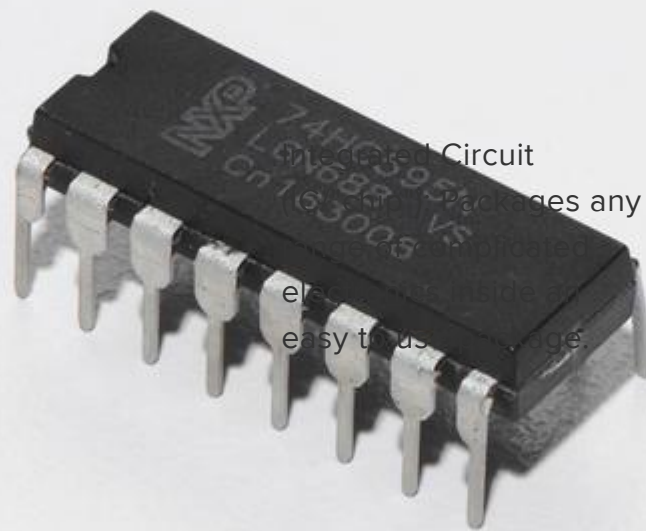

The part ID is written on the outside of the package (this sometimes requires a light or a magnifying glass to read)

2 to (this a TM with lead 74HC with lead



Push-button: Completes a circuit when it is pressed.

A little square with leads out the bottom and a button on the top.

4

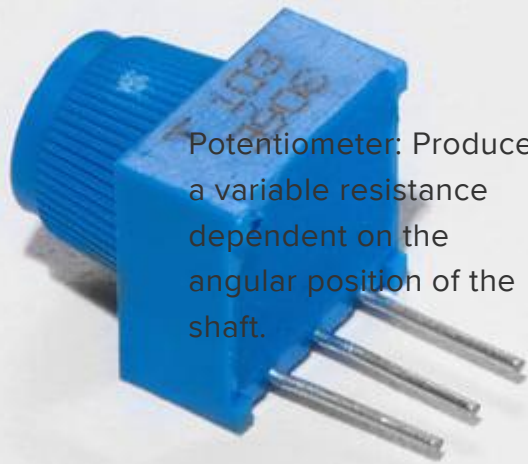

Potentiometer: Produces a variable resistance dependent on the angular position of the shaft.

They can be packaged in many different form factors, 3 look for a dial to identify this part.

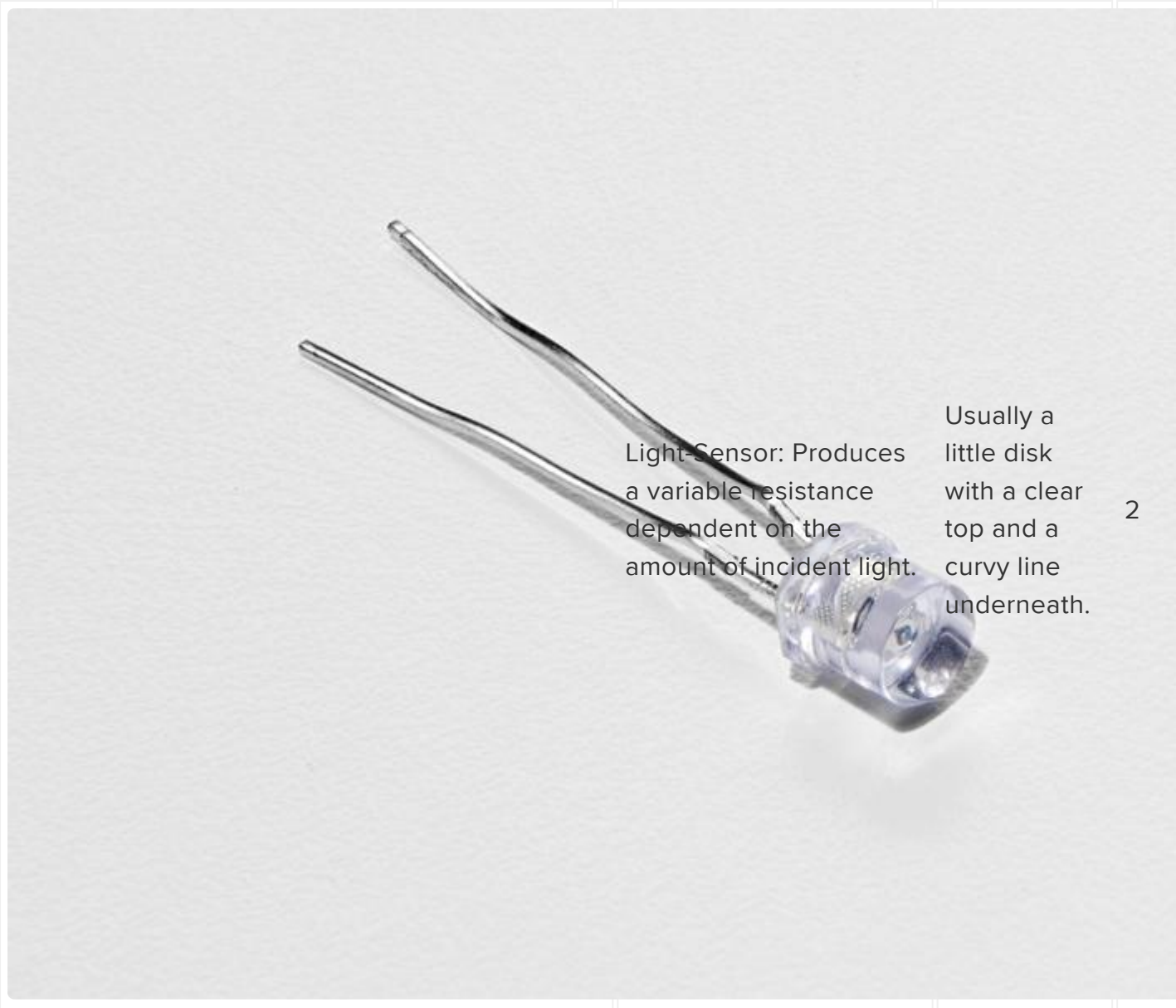

Light-Sensor: Produces a variable resistance dependent on the amount of incident light.

Usually a little disk with a clear top and a curvy line underneath.

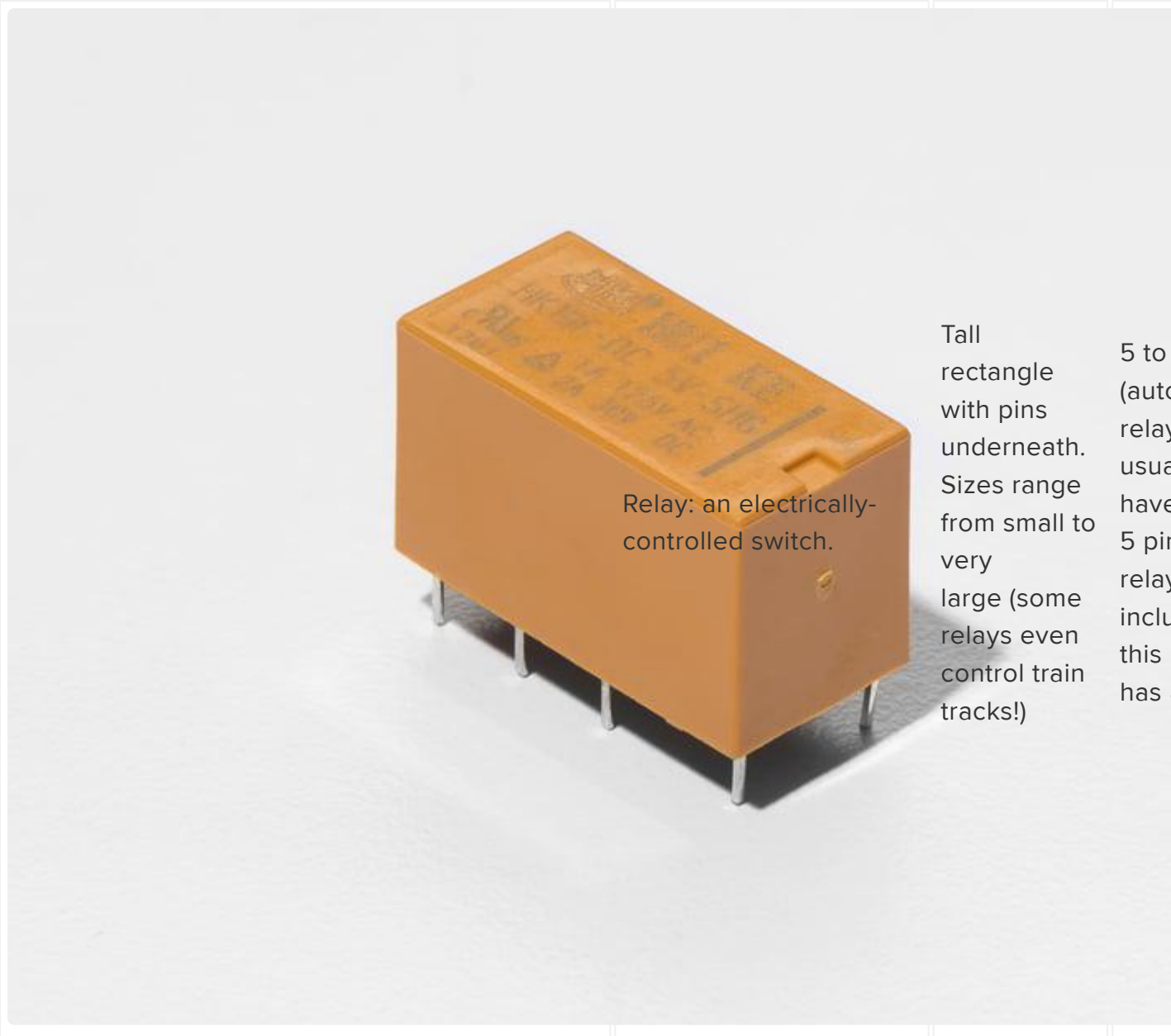

Relay: an electrically-controlled switch.

Tall rectangle with pins underneath. Sizes range from small to very large (some relays even control train tracks!)

5 to (auto relay usual have 5 pin relay include this has



Produces a variable resistance dependant on the amount of infrared light.

Usually a small rectangle with a bump.

3



Emits infrared light when a small current is passed through it. (only in one direction)

Looks like a small light bulb.

2



Emits pulses of infrared light following the NEC Infrared Transmission Protocol.

Looks like a TV remote.

0

Programming Primer

About Arduino Programming

The Adafruit Metro is programmed in the C language. This is a quick little primer targeted at people who have a little bit of programming experience and just need a briefing on the idiosyncrasies of C and the Arduino IDE. If you find the concepts a bit daunting, don't worry, you can start going through the circuits and pick up most of it along the way.

For a more in-depth explanation of topics discussed both here and in the language, [check out the Arduino.cc Reference page.](#) ()

The Arduino IDE

Now that Arduino is installed and configured, we're going to take a peek at it. Double click the Arduino icon to open it. It'll open up in a workspace, also called the IDE:

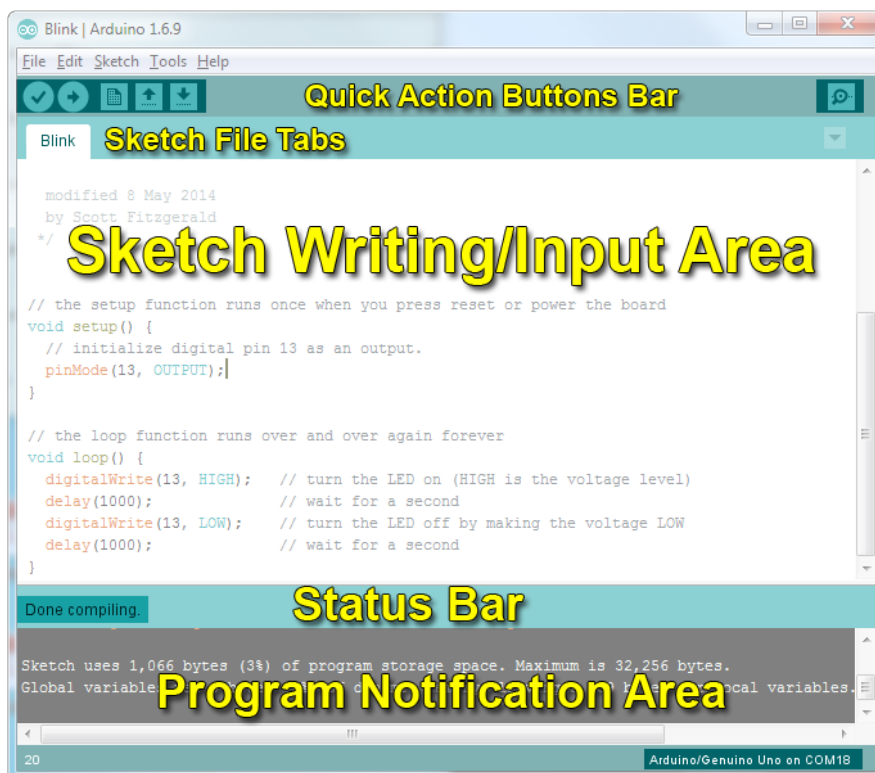

Don't feel overwhelmed - as you progress through the Experimenters Guide, you'll learn to use each part of the IDE.

Structure

You can think of the structure of an Arduino project like the scaffolding for a building. There's a specific structure that must be adhered to, or it all falls apart (and doesn't compile).

`void setup() { }`

All the code between the two curly brackets { } will be run only once when your Metro program first runs.

```
void setup() {  
  // put your setup code here, to run once  
}
```

`void loop() { }`

This function is run after `void setup()` has finished. After it has run once it will be run again, and again, forever, until power is removed.

```
void loop() {  
  // put your main code here, to run repeatedly  
}
```

Syntax

One of the slightly frustrating elements of C is its formatting requirements, or syntax. While frustrating, this also makes the language very powerful. If you remember the following you should be alright:

`//` (single line comment)

When writing a new sketch, or looking over an old one, having a comment to mark what you were thinking is important. To do this type two forward slashes and everything until the end of the line will be ignored by your program.

```
// this is a comment, it won't get run by the compiler  
this is not a comment, it will cause an error when run!!
```

`/* */` (multi-line comment)

If you have a lot to say, you can type on multiple lines using a multi-line comment. Everything between these two symbols will be ignored in your program just like the single line comment.

```
/*  
 * Oh, hey!  
 * hi there!  
*/
```

`{ }` (curly brackets)

These are used to mark when a block of code begins and ends. You'll see it used in functions and loops.

```
void serialPrintHello ()  
{ // code begins  
  Serial.println("Hello");  
} // code ends
```

`;` (the semicolon)

Each line of code must be ended with a semicolon. Missing a semicolon will cause your code to refuse to compile. It's often hard to find these, think of them as the hide and seek champion of your code and they're harder to overlook and cause errors.

```
// this will compile  
int servoPin = 5;  
// this won't compile, it's missing a semicolon  
int servoPin = 5
```

Variables

A program is nothing more than instructions to move numbers around in an intelligent way. Variables are used to do the moving.

int (integer)

The main workhorse. The integer stores a number in 2 bytes (or, 16 bits). It has no decimal places and will store a value between -32,768 and 32,767.

```
// this makes the variable i store the value 2
int i = 2;
```

long

The long is used when an integer is not large enough. Takes 4 bytes (32 bits) of RAM and has a larger range than an integer: between -2,147,483,648 and 2,147,483,647.

```
// this makes the variable j store the value 2000083647
long j = 2000083647
```

bool (boolean)

The boolean is a simple variable that can either be True or False. True corresponds to a bit '1' and False corresponds to '0', it's only one bit.

```
// let's make a boolean called openSource and
// set it to True
bool openSource = True;
// now let's make a variable called closedSource and
// set it to False
bool closedSource = False;
```

float

Used for floating point math, like decimals. Pi is a super long decimal, 3.1415...but it can be represented as a float such that it has more accurate precision (3.14 is more precise than just 3). It takes up 4 bytes (32 bits) of RAM and has a range between -3.4028235E+38 and 3.4028235E+38.

```
// integers can't store decimal points
int pi = 3;
// so we use a float!
float pi = 3.14;
```

char (character)

Stores one character using the ASCII code (ie 'A' = 65). Uses one byte (8 bits) of RAM. The Metro handles strings as an array of char's.

```
// mychar stores the letter A, represented by an ascii value of 65
char myChar = 'A';
```

Math

Now that we can store numbers in variables, we are going to manipulate them:

= (equals)

Makes something equal to something else.

```
// b equals one
int b = 1;
// now, the value stored in b equals b times 2, which is one
b = b * 2;
```

% (modulo)

Gives the remainder of a division operation.

```
// 12 divided by 10 = 1.2, modulo (%) will give us the remainder only
int mod = 12%10
// the value stored in int mod now equals 2
```

+ (addition)

Adds two numbers together.

```
int i = 2+2
// the value stored in int i now equals 4
```

- (subtraction)

Subtracts one number from another.

```
int f = 4-2
// the value stored in int f now equals 2
```

* (multiplication)

Multiplies two numbers together.

```
int z = 5*2
// the value stored in int z now equals 10
```

/ (division)

Divides two numbers.

```
int y = 10/2
// the value stored in int y now equals 5
```

Control Flow

Programs are able to control the flow of execution (what runs next). These are a couple basic elements that you should get familiar with:

If Conditions

This will execute the code between the curly brackets if the condition is true, and if not it will test the else if condition if that is also false the else code will execute.

```
int i = 0;

if(i > 5) {
    // this code does not execute, i is not greater than 5
}
else if (i > 2) {
    // this code also does not execute, i is not greater than 2
}
else {
    // this code DOES execute, i is none of the above, so it falls into
    // this category
}
```

for() Loops

Used when you would like to repeat a chunk of code a number of times (can count up `i++` or down `i--` or use any variable).

```
for (int i = 1; i < 5; i++) {  
  // this code will run 4 times  
}
```

Digital Input/Output

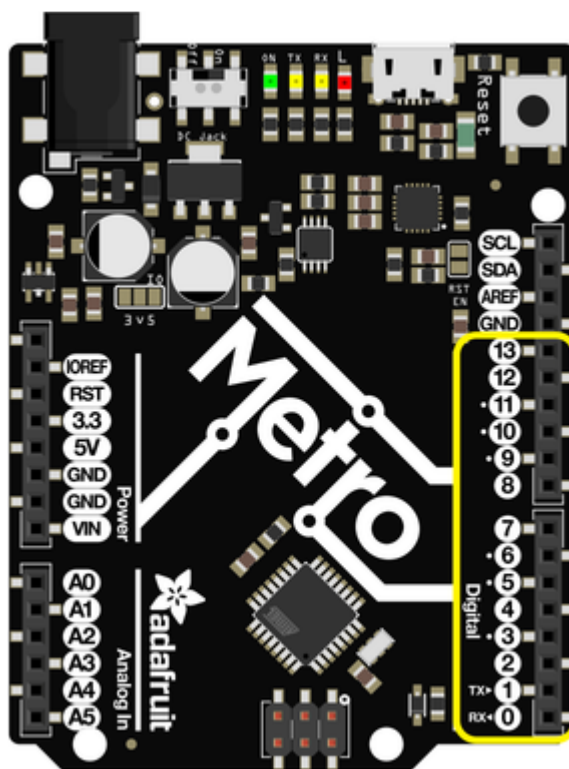

The right side of your Metro (or Metro Express) has a header containing 13 digital pins. These pins can be set to digital values ranging from 0 to 1023. The following commands pertain to these pins only:

pinMode(pin, mode)

Used to set a pin's mode.

Pin is the pin number you would like to address, Digital 0-19. You can also set digital pinModes on Analog pins 0-5. The mapping for 0-5 is 14-19.

Mode can either be set as an INPUT or an OUTPUT

```
// a red LED is connected on Pin #11
int redLedPin = 11;

void setup()
{
  // set the red LED as an OUTPUT
  pinMode(redLedPin, OUTPUT);
}
```

digitalWrite(pin, value)

If you set a pin as an OUTPUT using pinMode, you can then set it to either HIGH or LOW. Setting the pin HIGH will pull it up to +3.3V or +5V. Setting it low will pull it to ground, or zero volts.

```
// this code will flash the LED on and off forever
void loop()
{
  // set the pin high to turn ON the LED
  digitalWrite(redLedPin, HIGH);
  delay(500);
  // set the pin low to turn OFF the LED
  digitalWrite(redLedPin, LOW);
  delay(500);
}
```

digitalRead(pin)

Once a pin is set as an INPUT, you can use this to return whether it is HIGH (pulled to +5 volts) or LOW (pulled to ground).

```
// this will store the value of sensorPin in an integer called sensorValue
int sensorValue = digitalRead(sensorPin);
```

Analog Input/Output

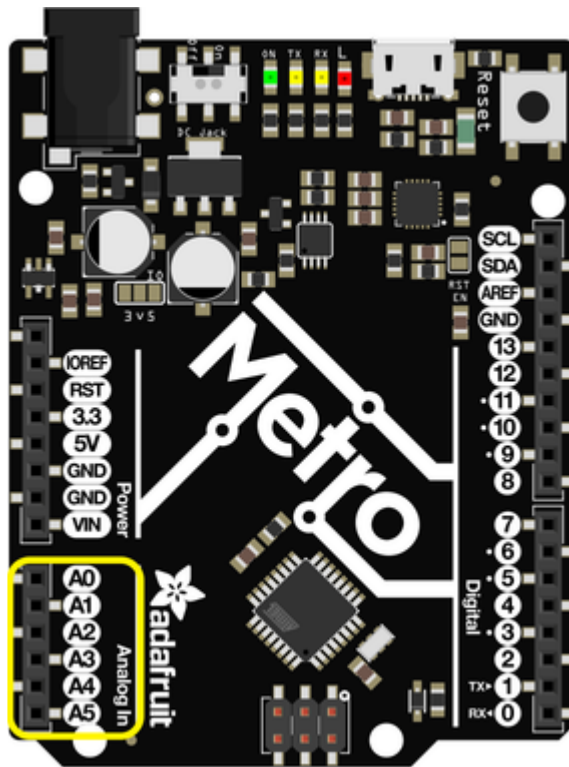

While the Metro is a digital board, it's able to do analog operations. This is useful for getting precise sensor values. Here's how to deal with things that aren't digital:

analogWrite(pin, value)

Through some "under the hood" tricks, the Metro is able to write analog values via Pulse Width Modulation. You can write any value between 0 and 255.

```
void loop()
{
  // set the LED to full brightness
  analogWrite(ledPin, 255);
  // turn the LED off
  analogWrite(ledPin, 0);
}
```

analogRead(pin)

Reads the value of the analog pin. The value returned can be between 0 and 1024.

```
sensorVal = analogRead(sensorPin);
```

Downloads

The experimenters guide has available source code and breadboard diagrams freely available for download on our GitHub:

Fritzing Diagrams



We designed the breadboard layout diagrams you see in this guide using the Open Source tool [Fritzing \(\)](#). If you'd like to view or modify any of these templates, click the button below:

Note: Most of the diagrams include components for Fritzing from the [Adafruit Fritzing Parts/Boards Library](#). [You'll need to download and install this order to edit our diagrams. \(\)](#)

Breadboard Fritzing Diagrams for
the Experimenters Guides

Code

Metro Explorers Guide Code

We also have the newest version of all of this guide's code stored in github Github repository. Feel free to submit issues, contributions, requests and modifications to this repository, we'll answer any questions you have in the [community support forums. \(\)](#)

What Board Do I Have?

This guide was designed to work with both the [Metro \(\)](#) and the [Metro Express \(\)](#). The main way to tell if your board is the express is if it says "express" on the board.

There's also a SWD port on the bottom of the Metro Express which isn't present on the Metro. The diagram below points these two differences out:

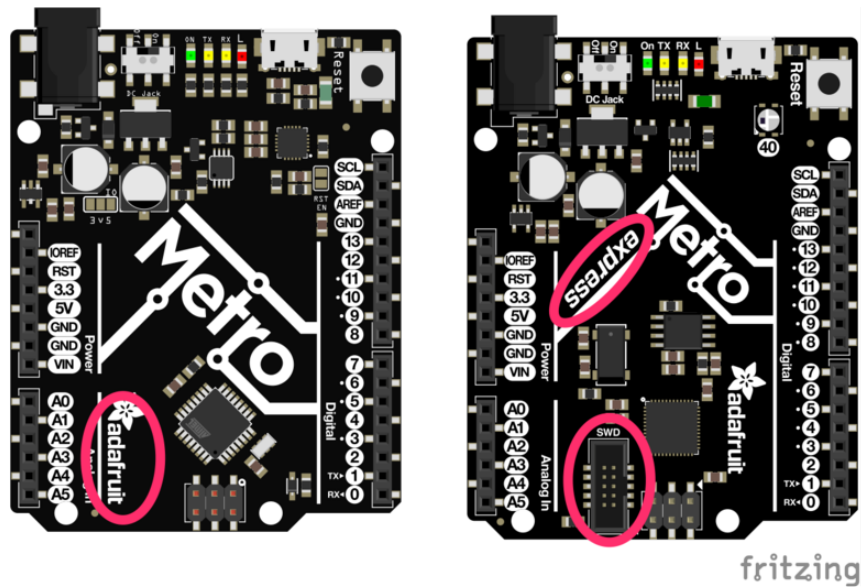

I have a Metro

This guide will work without any modification, follow the regular steps and have fun!

I have a Metro Express

There are two things to look out for while you work through this guide:

- 1) Wiring: Some circuits have an extra wiring page called "Wiring for Metro Express" and some don't. If the circuit you are looking at does not have this sub-page, use the regular Metro wiring. If you see the Metro Express Wiring page, use the wiring in that page instead.
- 2) Code: If there needs to be a modification in code for Metro Express, instructions will be present to switch the code to a Metro Express compatible code.

Setting up your Metro

MetroX Classic/Express Kit Users: Have you set up your mounting plate yet?

If you haven't assembled your Metro or Metro Express, Half-Sized Breadboard and Mounting Plate yet, [click here for instructions](#) ()

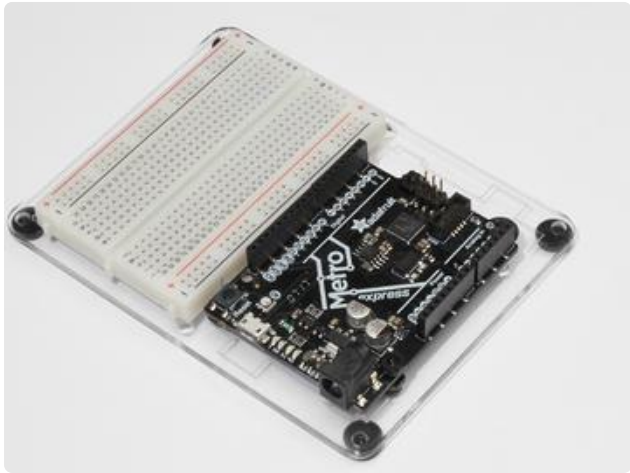

You'll need an [Adafruit Metro](#) () or Metro Express.

If you did not purchase the Metro Experimenter's Kit, you might want to purchase a [Half-size Breadboard](#) () and the [Plastic mounting plate for the breadboard](#). () It holds everything you need to experiment with small circuits nicely and keeps everything organized.



USB Micro Cable

I can't stress it enough. Make sure you have a good USB cable. Naughty USB cables will really ruin your day, like a stone in your shoe. Throw out bad cables and replace them with a good one - they are designed to be disposable!

A HUGE number of people have problems because they pick a 'charge-only' usb cable rather than a 'Data/Sync' cable. Make absolutely sure you have a good quality syncing cable. If you're having issues, you most likely have a charge-only cable.

Power your Metro!

If you have a Metro, these next steps will get you set up with the Arduino environment. [If you're not sure what board you have, click here.](#) ()

Connect your USB Micro cable to the USB Port of the Metro. The On LED should turn a solid green and remain on.

Arduino Bootloader Check.

Next you'll want to check if your Metro is programmed with the Arduino bootloader, which is required for use.



While plugged into power (make sure the On LED is turned on), quickly press the Reset button. You'll see it quickly flash three times. It happens really fast so don't worry if you can't see all three flashes.

Download the Arduino Software

This is the free application you'll use to write programs and talk to your Metro. There are instructions below for installation in most operating systems (and browser for Chromebook users running CodeBender!).

Go to the official Arduino Software page

Click the button above to go to the official software page (<https://www.arduino.cc/en/Main/Software> ()) and you'll see a box that looks like this:

ARDUINO 1.8.3
The open-source Arduino Software (IDE) makes it easy to write code and upload it to the board. It runs on Windows, Mac OS X, and Linux. The environment is written in Java and based on Processing and other open-source software.
This software can be used with any Arduino board. Refer to the [Getting Started](#) page for Installation instructions.

- Windows installer
- Windows ZIP file for non admin install
- Windows app [Get](#)
- Mac OS X 10.7 Lion or newer
- Linux 32 bits
- Linux 64 bits
- Linux ARM
- Release Notes
- Source Code
- Checksums (sha512)

The image above says Arduino 1.8.3, but I see a different version.

Don't worry, the Arduino Software is under constant revisions and the screenshot above is not representative of the latest version. Download the version for your platform.

Windows Setup

Downloading for Windows

Download and install with the Windows Installer. The .zip file (non-admin install) is not recommended unless you cannot run the installer.

(Windows) Installing Arduino

Click on the Windows Installer link to download the installer, then double click to launch it

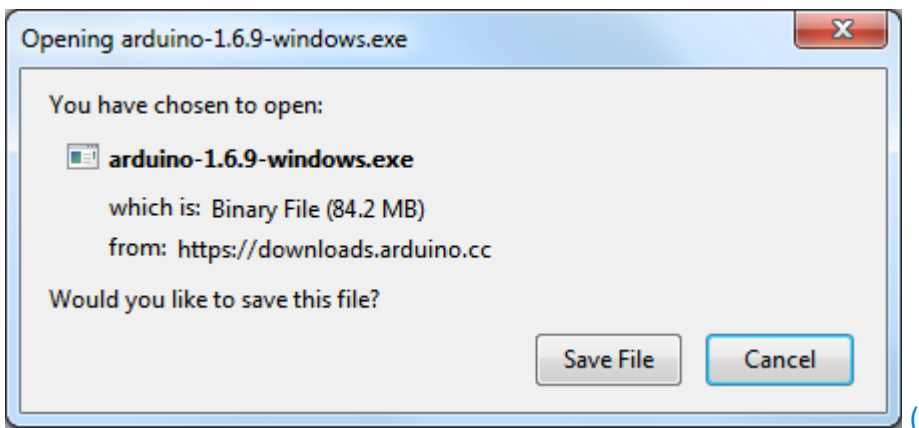

You may get a warning asking if you're sure you want to run the installer. It's ok, click YES

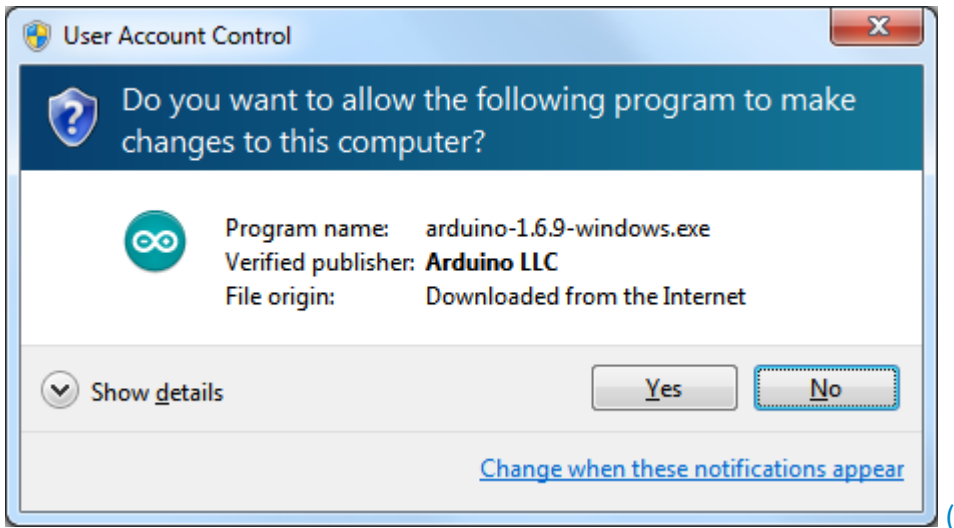

There is an open source license to click through. Install in the default location

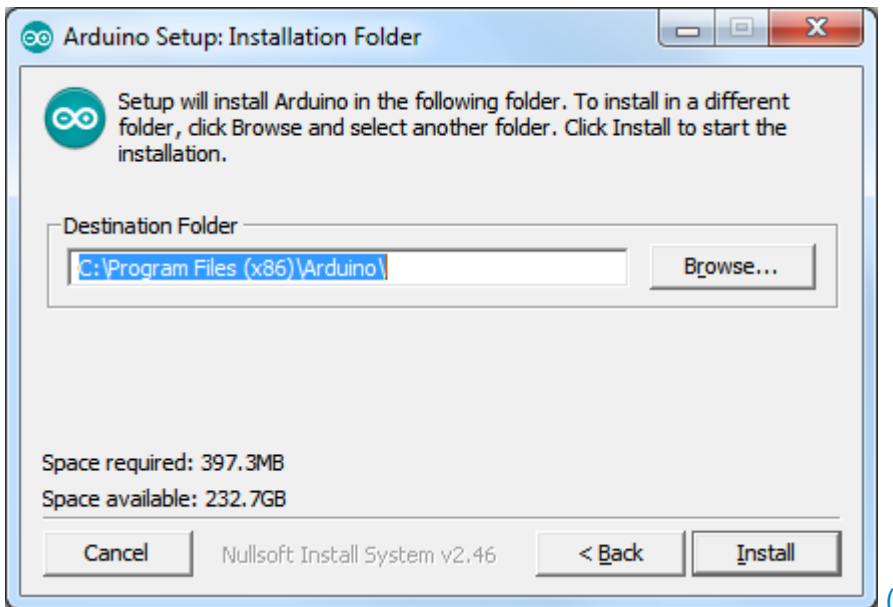

You can use the default setup installation options

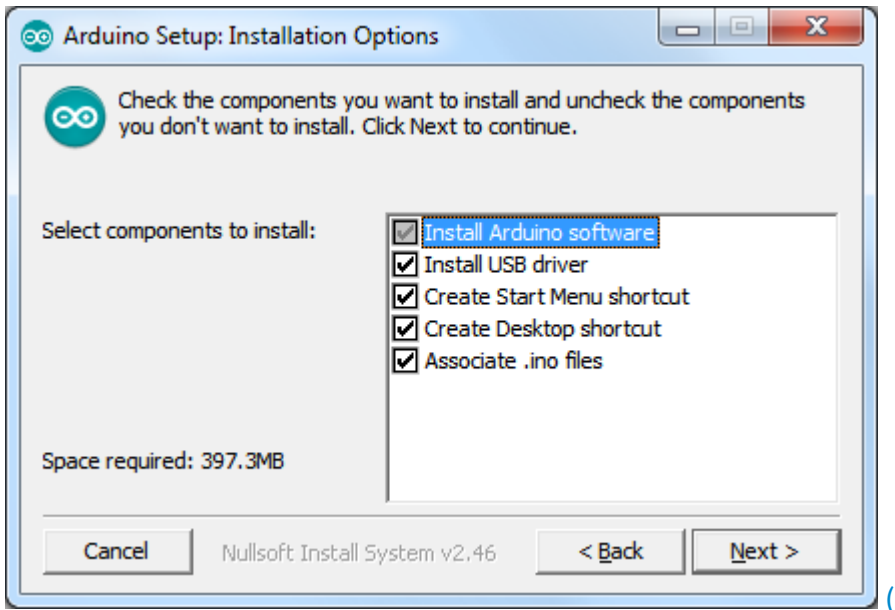

Finally it will take a minute or two to install

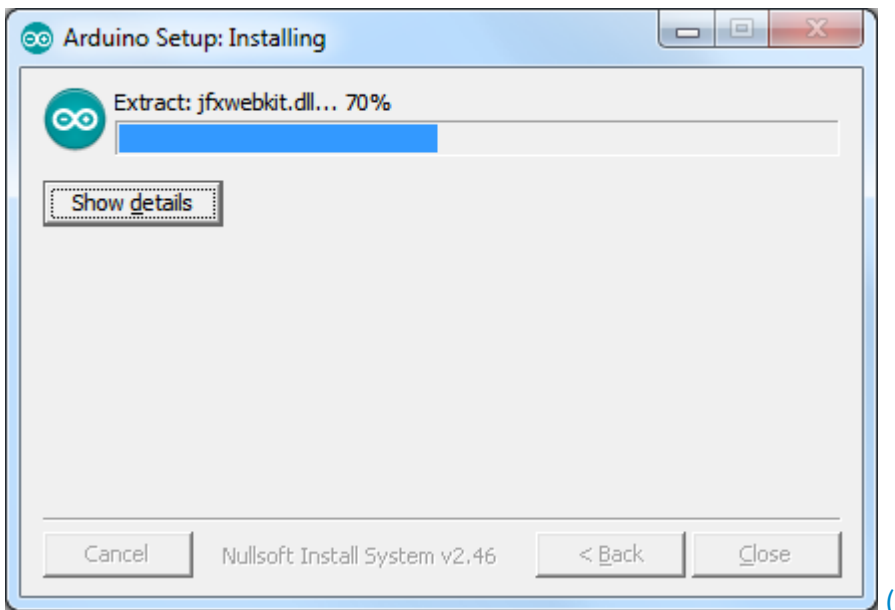

When done you'll have the software installed:

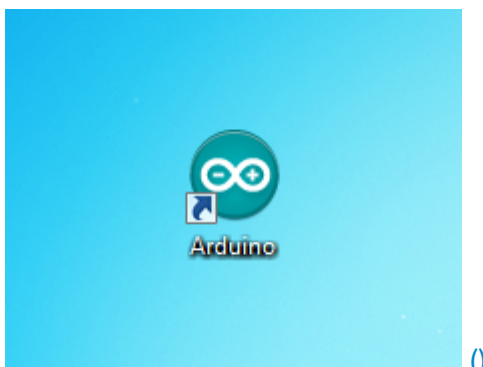

(Windows) Installing Drivers

Depending on your Arduino compatible you may need to install separate drivers for the USB to serial converter

For all Adafruit compatibles, we have an all in one installer that will install all of the Adafruit board drivers. It will also install the FTDI and CP210x drivers

Click below to download our Driver Installer:

[Download Adafruit Boards Windows Driver Installer](#)

Download and run the installer

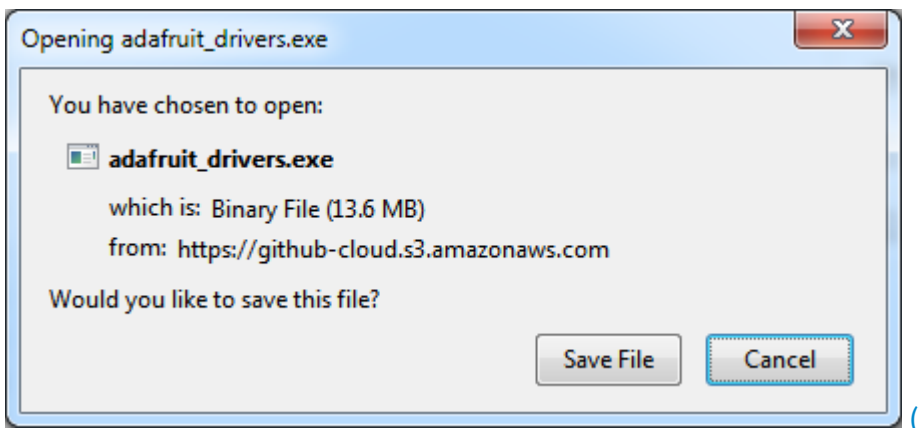

Run the installer! Since we bundle the SiLabs and FTDI drivers as well, you'll need to click through the license



Select which drivers you want to install (we suggest selecting all of them so you never have to worry about installing drivers when you start to explore other Arduino-compatibles)

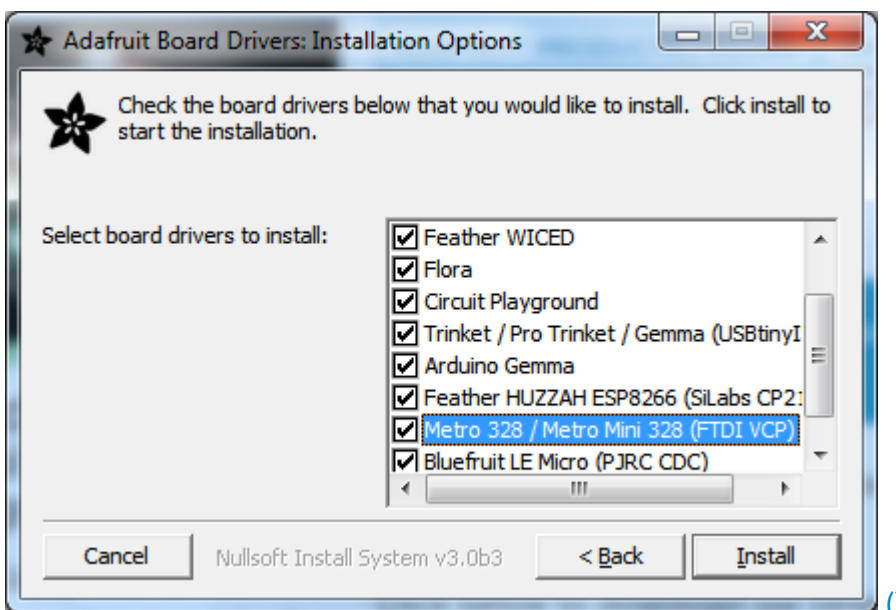

Click Install to do the installin'

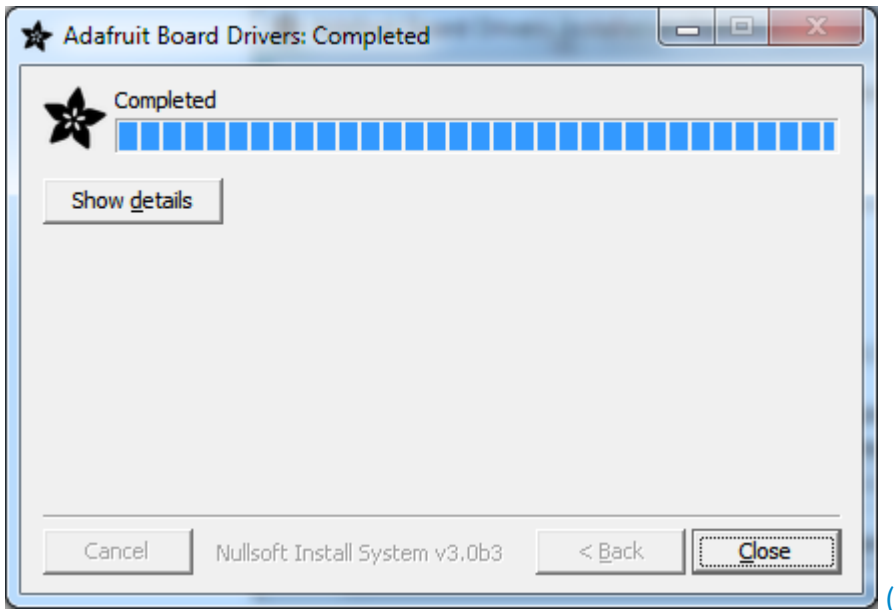

You should not need to restart your computer but it's not a bad idea!

(Windows) Find your Serial COM Port

To verify your Arduino driver installed properly, plug it into USB and open up the Device Manager. You can find the Device Manager in the Control Panel (search for Device Manager)

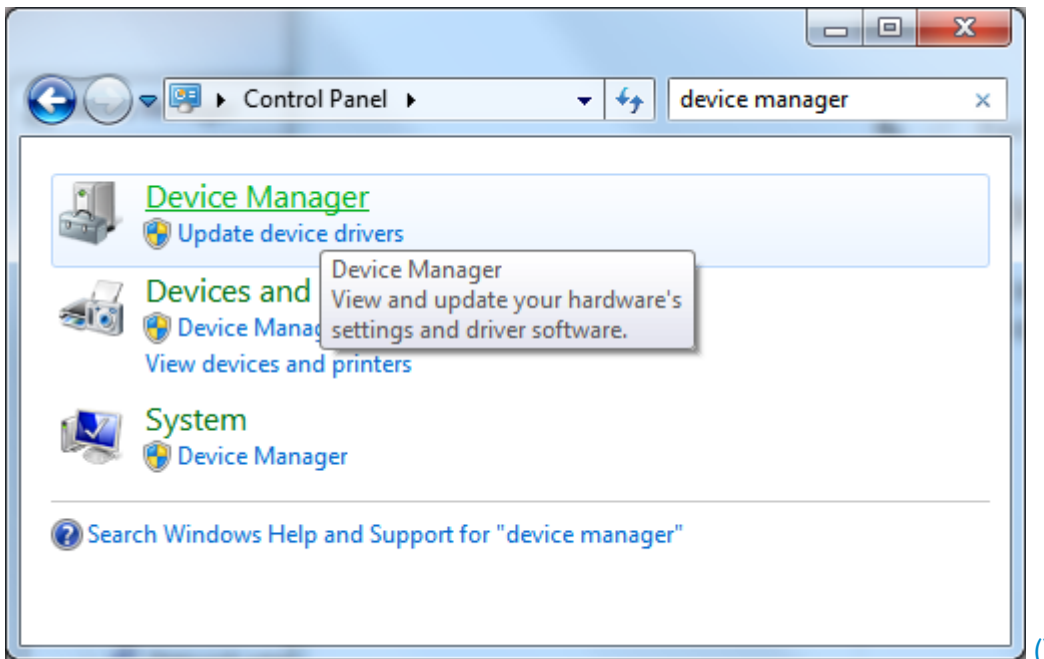

When you open the Device Manager, find the section called Ports and expand it:

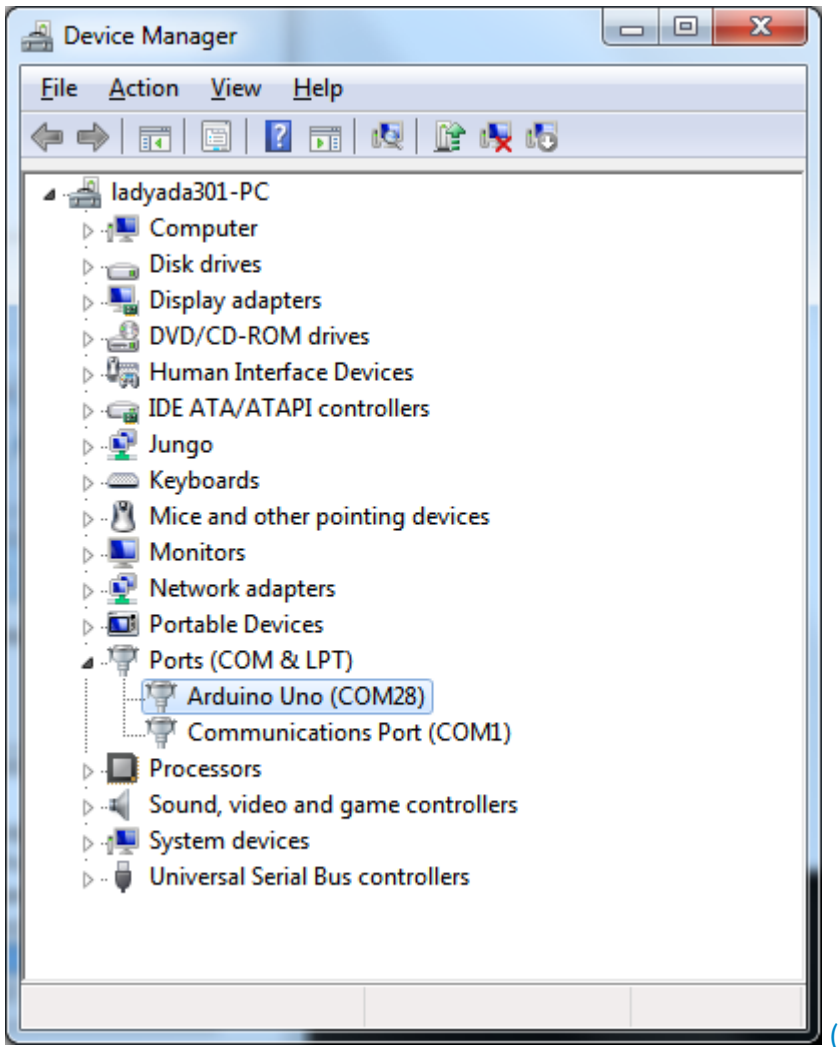

You'll see an icon next to some text that says Arduino UNO (COMxx) where xx is a number

If you have a Metro, it won't say Arduino UNO, just USB Serial Port (COMxx)

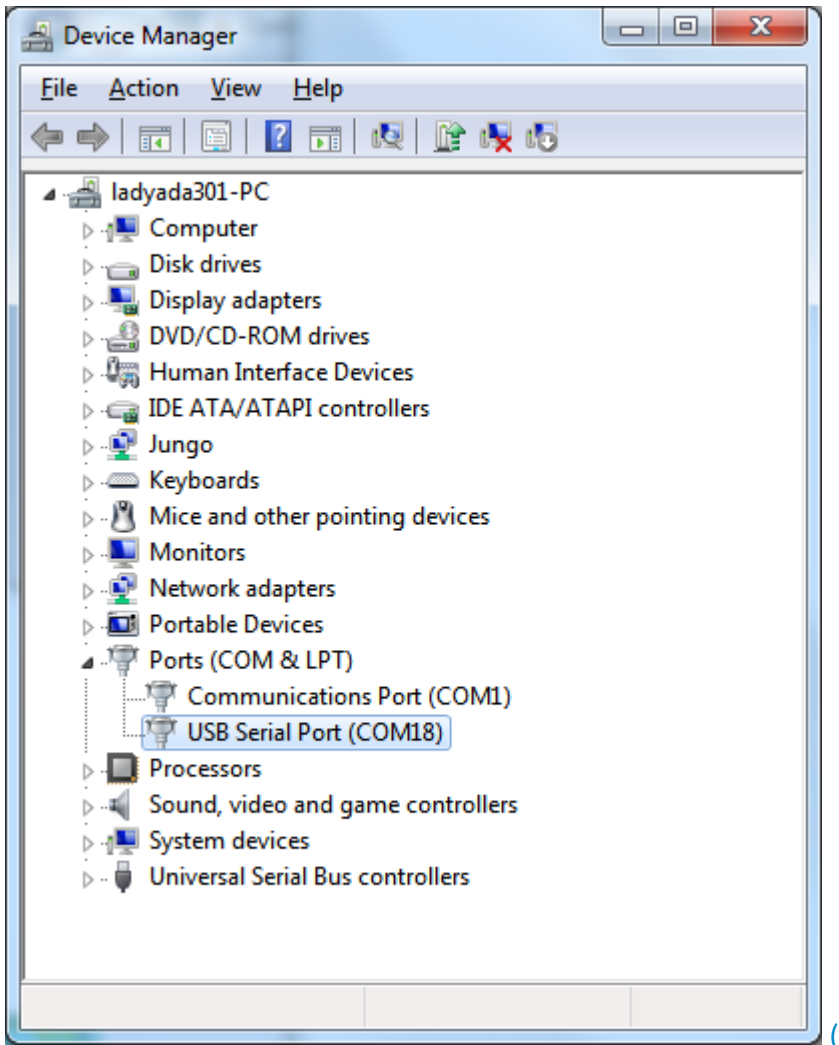

The COM number may vary but it should be something like COM3 or COM4. The COM stands for "communication", and each one has a unique number, known as the COM Port number. In this case the COM Port number is COM18.

You can unplug your Arduino to see the COM port device disappear and re-appear when plugged in.

If you don't see the Arduino show up, check:

- Is your cable a data cable or charge only? Try another USB cable
- Try another USB port!
- Verify you installed the drivers, you can always try installing them again (never hurts)
- Check your Arduino does not need some other drivers, your vendor can point you at the right driver if necessary

Mac Setup

Downloading for macOS or OS X

Download the version for Mac OS X, uncompress the .zip file, and drag the Application out of the folder.

(macOS/OS X) Installing Arduino

Click on the Mac OS X Installer link to download the installer

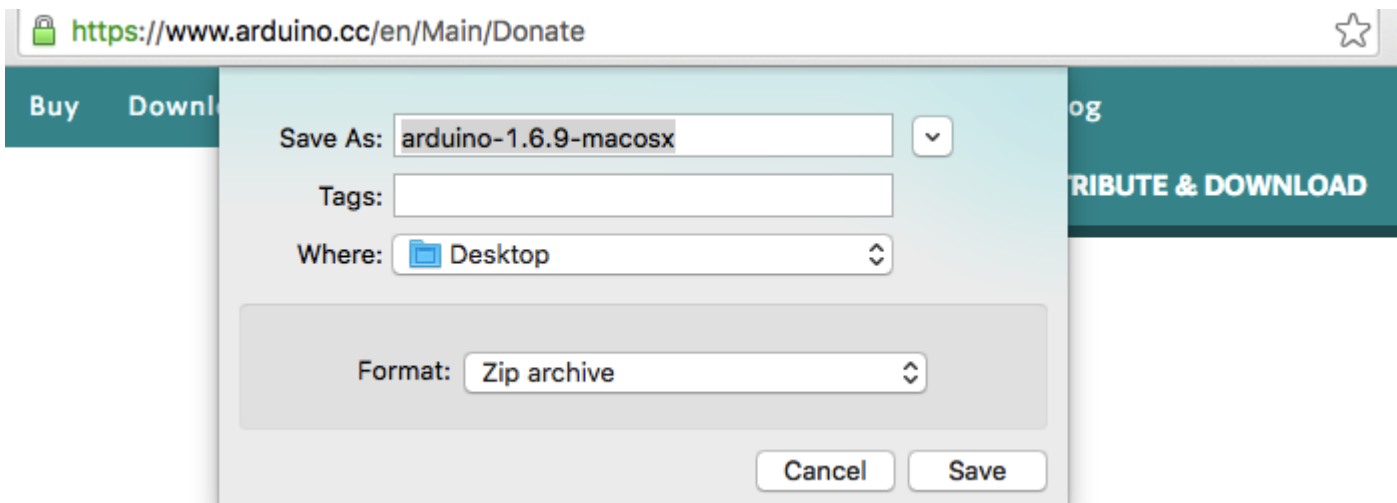

Then double click to expand/launch it

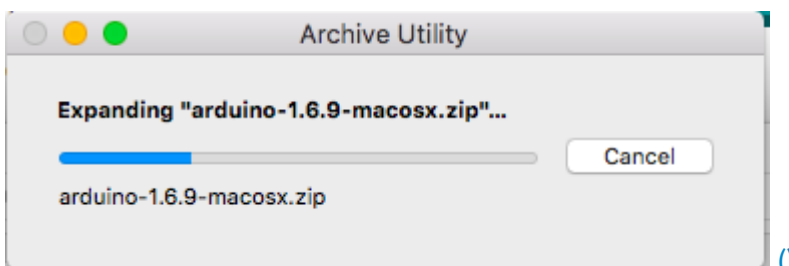

it will automatically give you the Arduino app the teal icon:

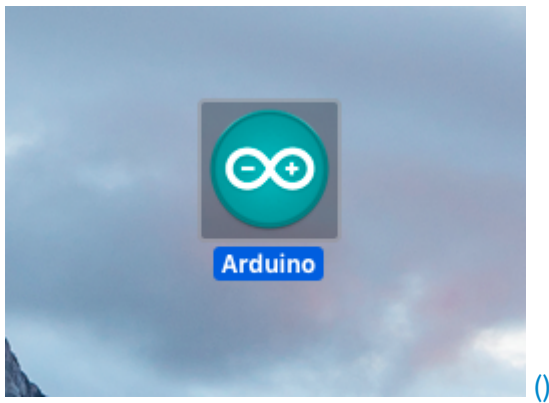

(macOS/OS X) Find your Serial Port

Now we want to ensure your Metro is properly communicating with your computer. In your Applications folder, find the Utilities folder and double click it.

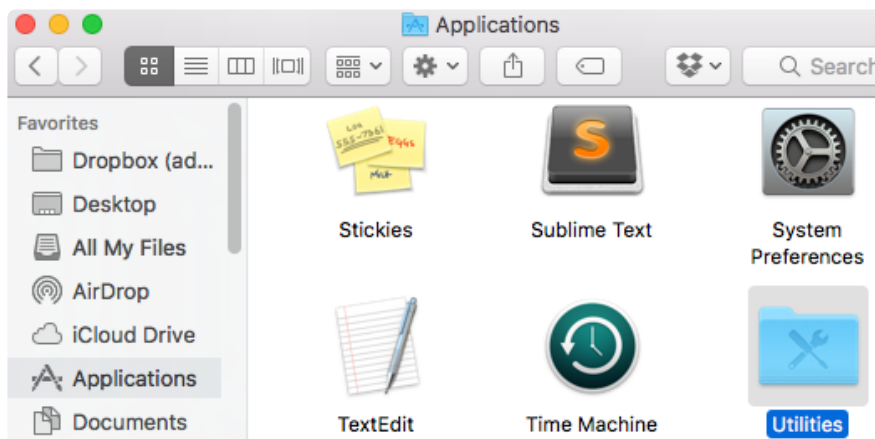

Then, find the application named "Terminal". Double click it to open:

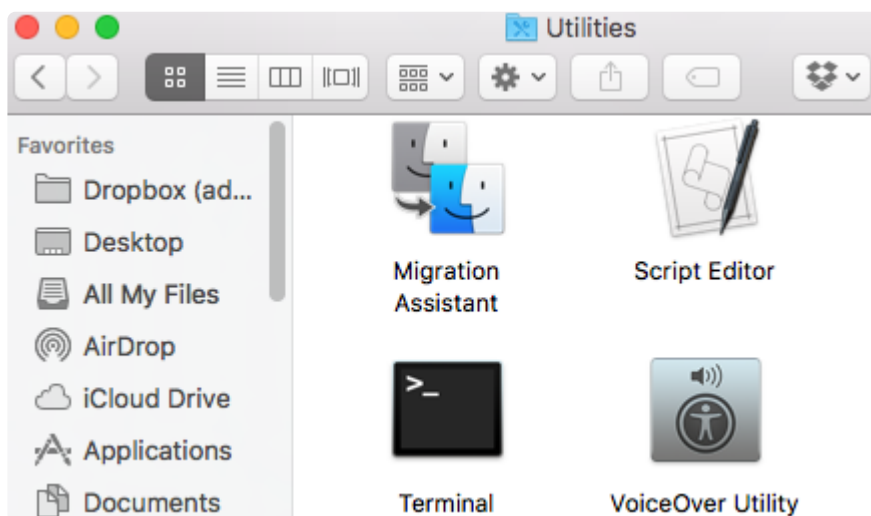

Once Terminal is open, you'll be greeted by a prompt. Type the following into it:

```
ls /dev/cu*
```

```
Brent — -bash — 80x24
Last login: Tue Aug 1 13:52:03 on ttys000
Brent at mba in ~
$ ls /dev/cu.*
/dev/cu.Bluetooth-Incoming-Port /dev/cu.usbmodem353
/dev/cu.usbmodem1411           /dev/cu.usbserial-ADAQEQQP3
```

Once that's typed in, you should see a line with the text /dev/cu.usbmodemxxxx OR /dev/cu.usbserial-xxxxx. The xxxx's can be any letter or number. If you see this, the driver was installed properly and the Metro was found on your computer.

If you're not comfortable about using Terminal, there's another (easier) way to check if everything's been installed properly. Click on the Apple Icon on your menubar. In the dropdown menu, click About This Mac.

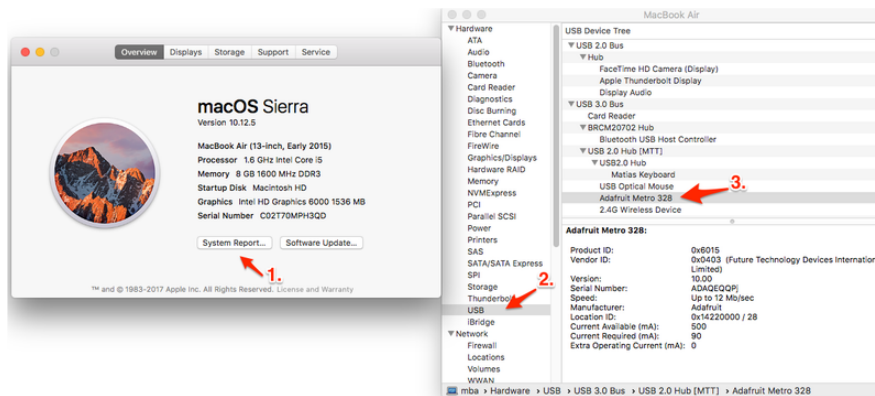

Then, click on System Report. System Profiler will open, then click on USB in the Hardware drop-down menu. You should see the Adafruit Metro 328 as one of your USB devices.

(macOS / OS X) Installing Drivers

Next, you'll want to grab and install the FTDI VCP Drivers and the SiLabs CP210x Drivers.

[First, navigate to the FTDI VCP Site and grab the driver for your OS X version and platform. \(\)](#)

Currently Supported VCP Drivers:

Operating System	Release Date	x86 (32-bit)	x64 (64-bit)
Windows*	2017-03-10	2.12.26	2.12.26
Linux	2009-05-14	1.5.0	1.5.0
Mac OS X 10.3 to 10.8	2012-08-10	2.2.18	2.2.18
Mac OS X 10.9 and above	2017-05-12	-	2.4.2
Windows CE 4.2-5.2**	2012-01-06	1.1.0.20	-
Windows CE 6.0/7.0	2016-11-03	1.1.0.22 CE 6.0 CAT CE 7.0 CAT	-
Windows CE 2013	2015-03-06	1.0.0	-

Then, unzip the file and install the .dmg file.

[You'll also need the SiLabs CP210x Drivers. You can get them from the SiLabs site. \(\)](#)

silabs.com/products/development-tools/software/usb-to-uart-bridge-vcp-drivers

Platform	Software
 Windows 2K	Download VCP (4.79 MB)

Download for WinCE

Platform	Software
 WinCE 6.0 (2.1)	Download VCP (276 KB)
 WinCE 5.0 (2.1)	Download VCP (271 KB)

Download for Macintosh OSX (v4)

Platform	Software
 Mac OS X	Download VCP (832 KB)

Then, unzip the file and install the .dmg file.

Verifying macOS / OS X Drivers

We just want to verify that everything is correctly set up. Plug your Metro Classic in, then open the Arduino IDE and navigate to Tools > Port.



You should see a device listed as `/dev/cu.usbserial`, followed by number and/or letters. This is your Metro Classic.

If you don't see this, ensure your FTDI and SILabs drivers are correctly installed (for both the right OS Version and Platform). Then, check both the USB port you're using (try another port) or a cable (you might be using a charge-only cable).

Linux Setup

Downloading for Linux

There are download options available for both 32-bit and 64-bit Linux. Download the version for the system you're using, manually decompress the `.tar` file, and install the software.

(Linux) Installing Arduino

Click on the matching Linux Installer link (32 bit, 64 bit or ARM) to download the installer - save the file to your Downloads folder

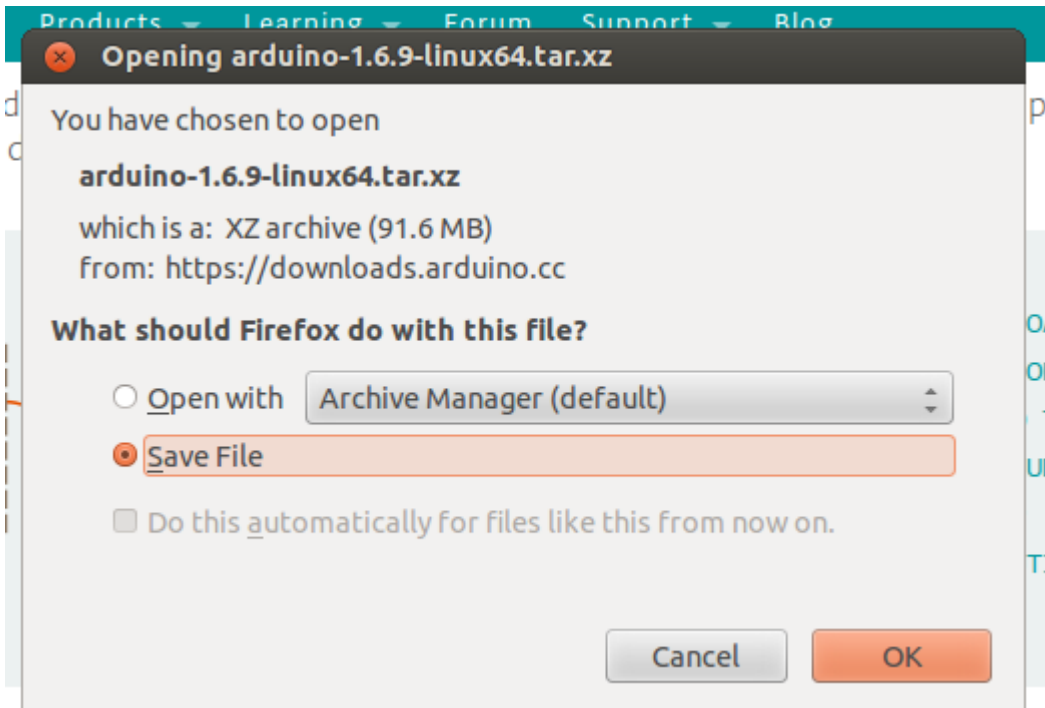

From within your Terminal program, cd to the Downloads directory, and untar the package with `tar xf arduino*.xz` then cd into the `arduino-n.n.n` folder created:

```
ladyada@ladyada-VirtualBox: ~/Downloads/arduino-1.6.9

ladyada@ladyada-VirtualBox:~$ cd ~/Downloads/
ladyada@ladyada-VirtualBox:~/Downloads$ ls
arduino-1.6.9-linux32.tar.xz  arduino-1.6.9-linux64.tar.xz
ladyada@ladyada-VirtualBox:~/Downloads$ tar -xf arduino-1.6.9-linux64.tar.xz
ladyada@ladyada-VirtualBox:~/Downloads$ ls
arduino-1.6.9  arduino-1.6.9-linux32.tar.xz  arduino-1.6.9-linux64.tar.xz
ladyada@ladyada-VirtualBox:~/Downloads$ cd arduino-1.6.9/
ladyada@ladyada-VirtualBox:~/Downloads/arduino-1.6.9$ ls
arduino      examples    java        reference   tools-builder
arduino-builder  hardware    lib         revisions.txt  uninstall.sh
dist         install.sh  libraries   tools
ladyada@ladyada-VirtualBox:~/Downloads/arduino-1.6.9$
```

Run `./install.sh` to install the software. I've got an old Ubuntu install so I got warnings, but it did create that desktop icon for me!



(Linux) Installing Drivers

Linux doesn't have any drivers to install, assuming you're running a v2.6 kernel or higher, which is almost certainly true. These instructions assume you're running Ubuntu. Each Linux distribution is different, but the instructions should be basic enough to follow for other distros.

You can verify your kernel version by running `uname -a` in a terminal window, note that this kernel is version 2.6.20

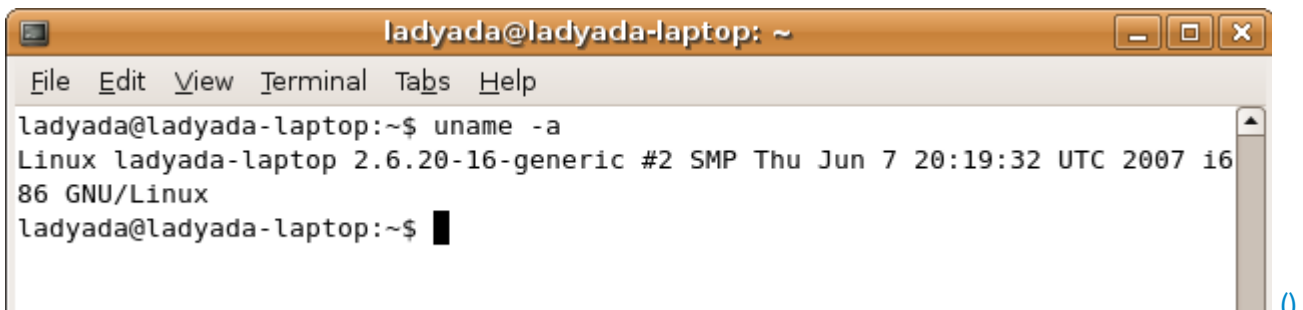

And this one is 3.2.0-23

```
ladyada@ladyada-VirtualBox: ~
ladyada@ladyada-VirtualBox:~$ uname -a
Linux ladyada-VirtualBox 3.2.0-23-generic-pae #36-Ubuntu SMP Tue Apr 10 22:
UTC 2012 i686 i686 i386 GNU/Linux
ladyada@ladyada-VirtualBox:~$
```

Some older Linux distributions used to install brltty (braille device) which will conflict with the Arduino. You must uninstall brltty if it is installed! Do so by running `sudo apt-get remove brltty` or equivalent in a terminal window. If it says it's not installed then that's OK. If you're not running a Debian-derived installation use whatever tool is necessary to verify that you don't have brltty running

(Linux) Find your Serial Port

Plug in the Arduino, verify that the green LED is lit, and type `ls /dev/ttyUSB*` into a terminal window, you should see a device file called something like `ttyUSB0`

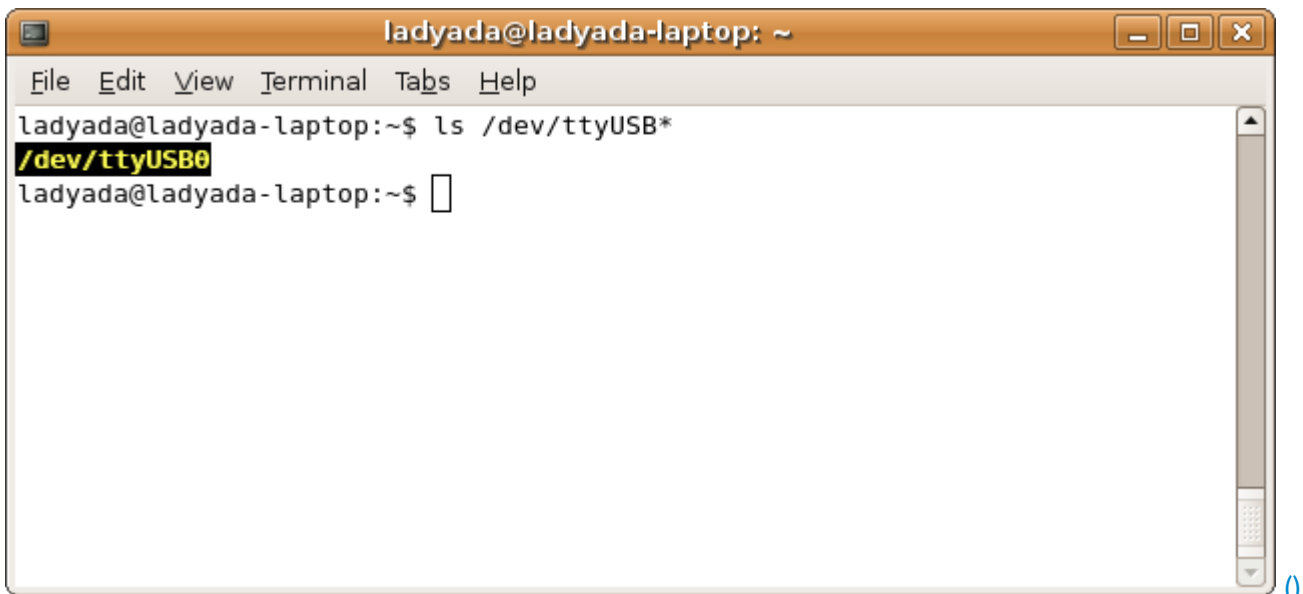

```
ladyada@ladyada-laptop: ~
File Edit View Terminal Tabs Help
ladyada@ladyada-laptop:~$ ls /dev/ttyUSB*
/dev/ttyUSB0
ladyada@ladyada-laptop:~$
```

If you can't seem to find it, use `dmesg | tail` right after plugging in the Arduino and look for hints on where it may put the device file. For example here it says Serial Device converter now attached to `ttyUSB0`



```
ladyada@ladyada-laptop: ~  
File Edit View Terminal Tabs Help  
ladyada@ladyada-laptop:~$ dmesg | tail  
[ 455.092000] drivers/usb/serial/usb-serial.c: USB Serial support registered for generic  
[ 455.096000] usbcore: registered new interface driver usbserial_generic  
[ 455.096000] drivers/usb/serial/usb-serial.c: USB Serial Driver core  
[ 455.120000] drivers/usb/serial/usb-serial.c: USB Serial support registered for FTDI USB Serial Device  
[ 455.120000] ftdi_sio 1-2:1.0: FTDI USB Serial Device converter detected  
[ 455.120000] drivers/usb/serial/ftdi_sio.c: Detected FT232BM  
[ 455.124000] usb 1-2: FTDI USB Serial Device converter now attached to ttyUSB0  
[ 455.124000] usbcore: registered new interface driver ftdi_sio  
[ 455.124000] drivers/usb/serial/ftdi_sio.c: v1.4.3:USB FTDI Serial Converters Driver  
[ 502.812000] ADDRCONF(NETDEV_UP): wlan0: link is not ready  
ladyada@ladyada-laptop:~$
```

If you see something like this

```
[ 1900.712000] ftdi_sio 2-10:1.0: FTDI USB Serial Device converter detected  
[ 1900.712000] drivers/usb/serial/ftdi_sio.c: Detected FT232BM  
[ 1900.712000] usb 2-10: FTDI USB Serial Device converter now attached to ttyUSB0  
[ 1901.868000] usb 2-10: usbfs: interface 0 claimed by ftdi_sio while 'brltty' sets config #1  
[ 1901.872000] ftdi_sio ttyUSB0: FTDI USB Serial Device converter now disconnected from ttyUSB0  
[ 1901.872000] ftdi_sio 2-10:1.0: device disconnected
```

That means you have not uninstalled brltty and you should try again.

Configure Arduino for the Metro Express

This page is only for Metro EXPRESS users, if you have a regular Metro, you can ignore this page.

If you've followed the [Setting up your Metro Express \(\)](#) page, you should be ready to roll. We need to make some modifications to Arduino to allow it to work with the Metro Express.

Metro Express Arduino IDE Setup

After you have downloaded and installed the latest version of Arduino IDE, you will need to start the IDE and navigate to the Preferences menu. You can access it from the File menu in Windows or Linux, or the Arduino menu on OS X.

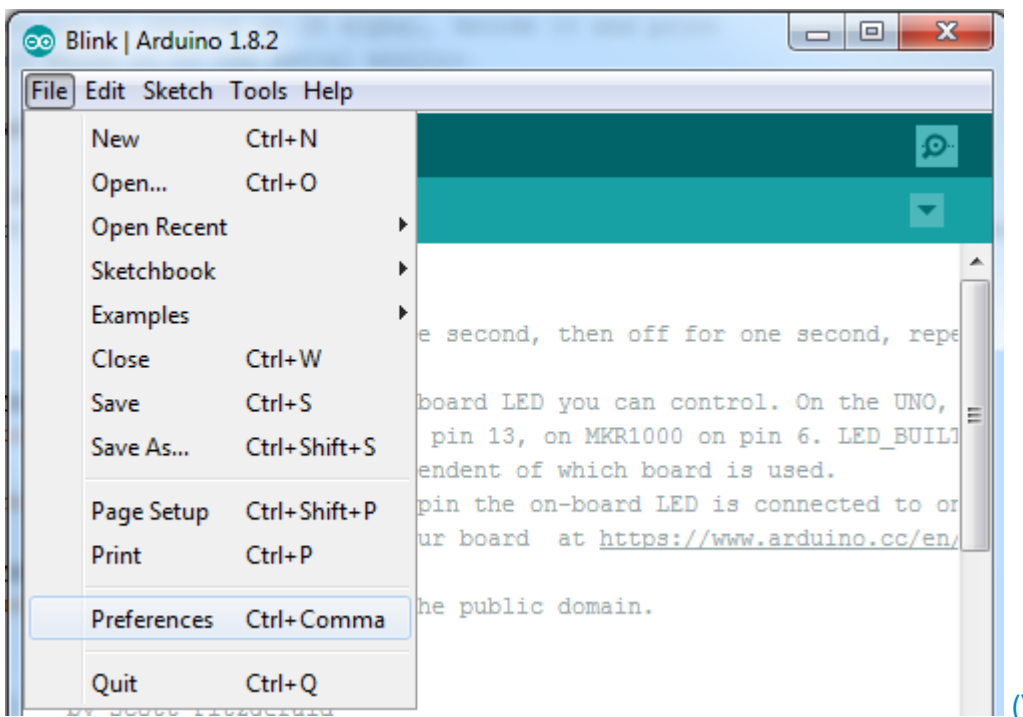

A dialog will pop up just like the one shown below.

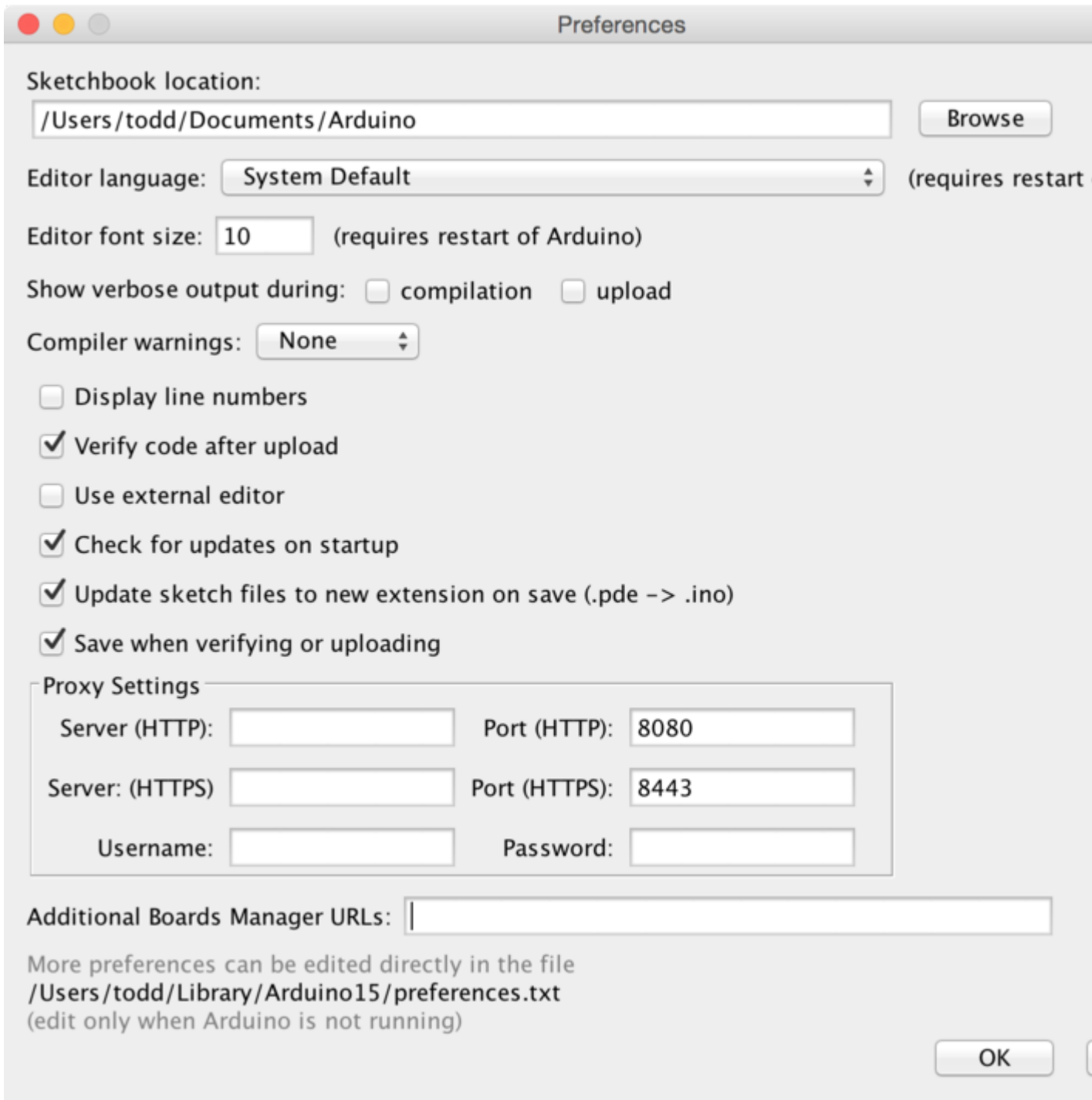

We will be adding a URL to the new Additional Boards Manager URLs option. The list of URLs is comma separated, and you will only have to add each URL once. New Adafruit boards and updates to existing boards will automatically be picked up by the Board Manager each time it is opened. The URLs point to index files that the Board Manager uses to build the list of available & installed boards.

To find the most up to date list of URLs you can add, you can visit the list of [third party board URLs on the Arduino IDE wiki](#) (). We will only need to add one URL to the IDE in this example, but you can add multiple URLs by separating them with commas. Copy

and paste the link below into the Additional Boards Manager URLsoption in the Arduino IDE preferences.

https://adafruit.github.io/arduino-board-index/package_adafruit_index.json

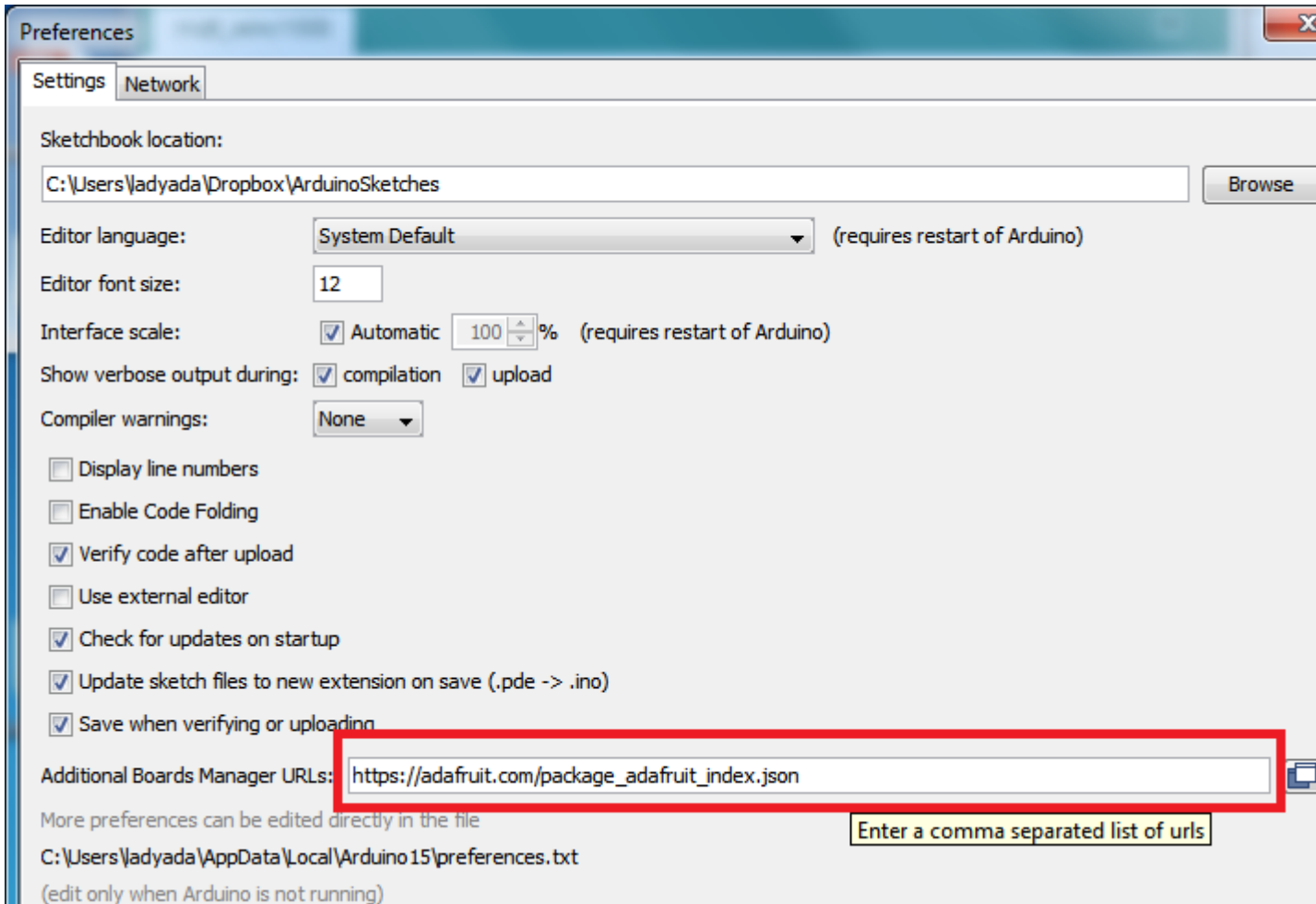

Here's a short description of each of the Adafruit supplied packages that will be available in the Board Manager when you add the URL:

- Adafruit AVR Boards - Includes support for Flora, Gemma, Feather 32u4, Trinket, & Trinket Pro.
- Adafruit SAMD Boards - Includes support for Feather M0, Metro M0, Circuit Playground Express, Gemma M0 and Trinket M0
- Arduino Leonardo & Micro MIDI-USB - This adds MIDI over USB support for the Flora, Feather 32u4, Micro and Leonardo using the [arcore project](#) ().

If you have multiple boards you want to support, say ESP8266 and Adafruit, have both URLs in the text box separated by a comma (,)

Once done click OK to save the new preference settings. Next we will look at installing boards with the Board Manager.

Now continue to the next step to actually install the board support package!

Using the Metro Express with Arduino IDE

Since the Metro Express M0 uses an ATSAM21 chip running at 48 MHz, you can pretty easily get it working with the Arduino IDE. Most libraries (including the popular ones like NeoPixels and display) will work with the M0, especially devices & sensors that use i2c or SPI.

Now that you have added the appropriate URLs to the Arduino IDE preferences in the previous page, you can open the Boards Manager by navigating to the Tools->Board menu.

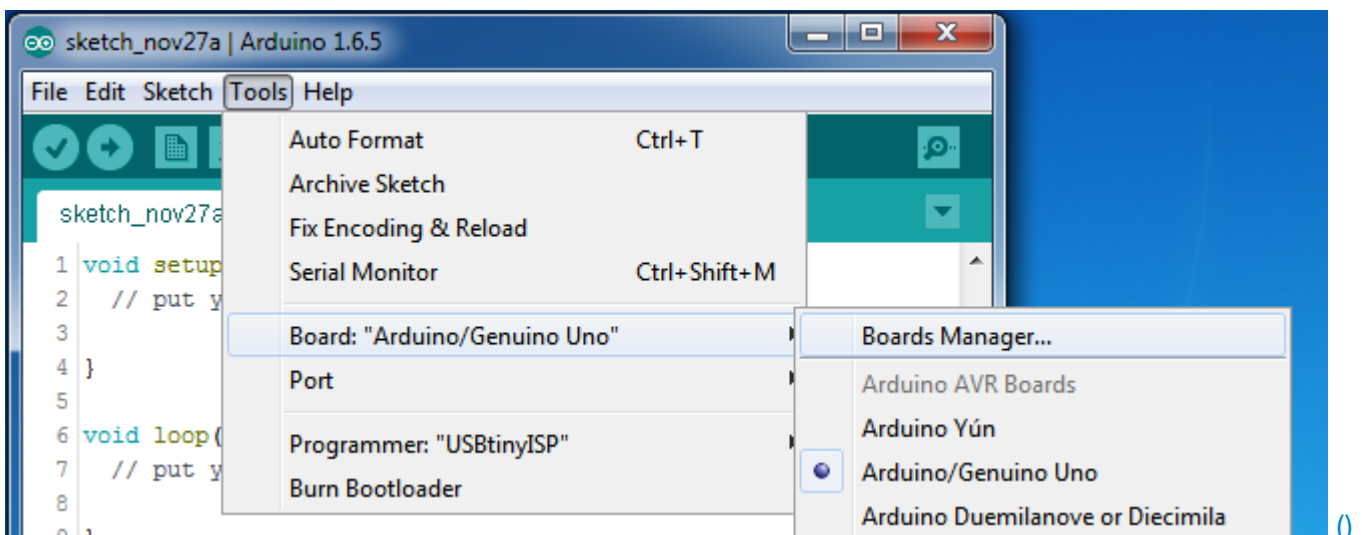

Once the Board Manager opens, click on the category drop down menu on the top left hand side of the window and select Contributed. You will then be able to select and install the boards supplied by the URLs added to the preferences.

Install SAMD Support

First up, install the Arduino SAMD Boards version 1.6.15 or later

You can type Arduino SAMD in the top search bar, then when you see the entry, click I nstall

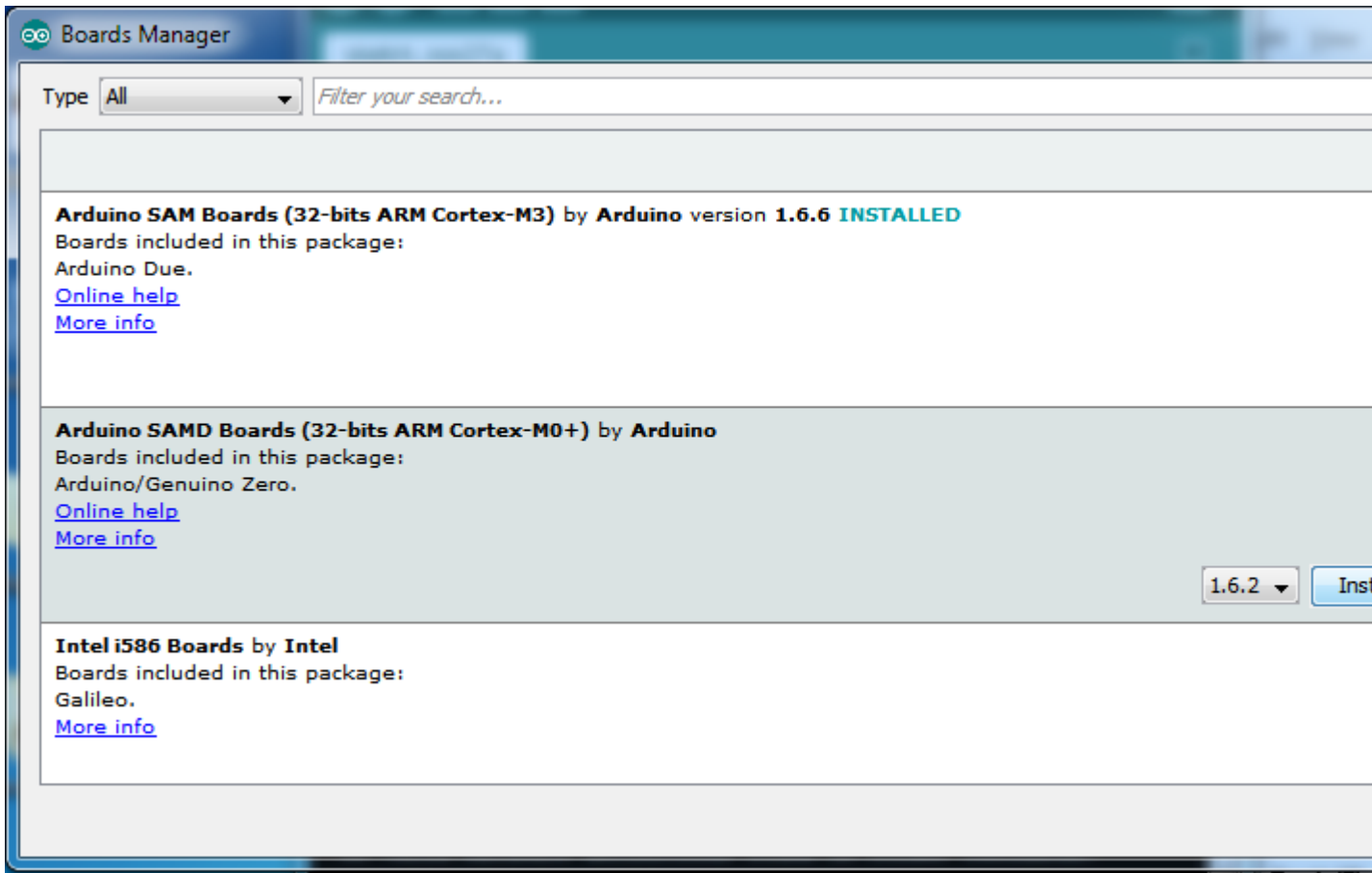

Install Adafruit SAMD

Next you can install the Adafruit SAMD package to add the board file definitions

You can type Adafruit SAMD in the top search bar, then when you see the entry, click Install

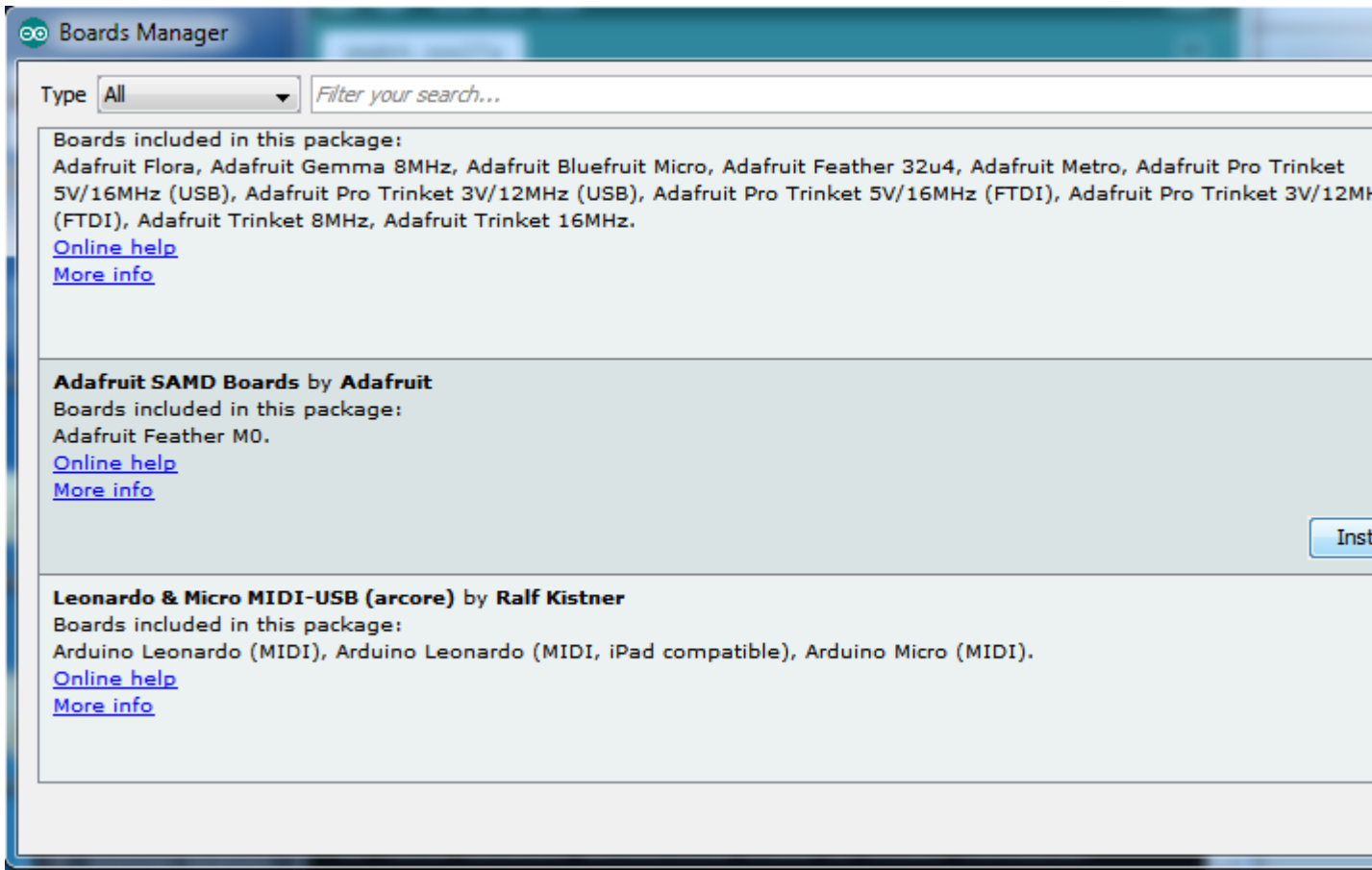

Even though in theory you don't need to - I recommend rebooting the IDE

Quit and reopen the Arduino IDE to ensure that all of the boards are properly installed. You should now be able to select and upload to the new boards listed in the Tools->Board menu.

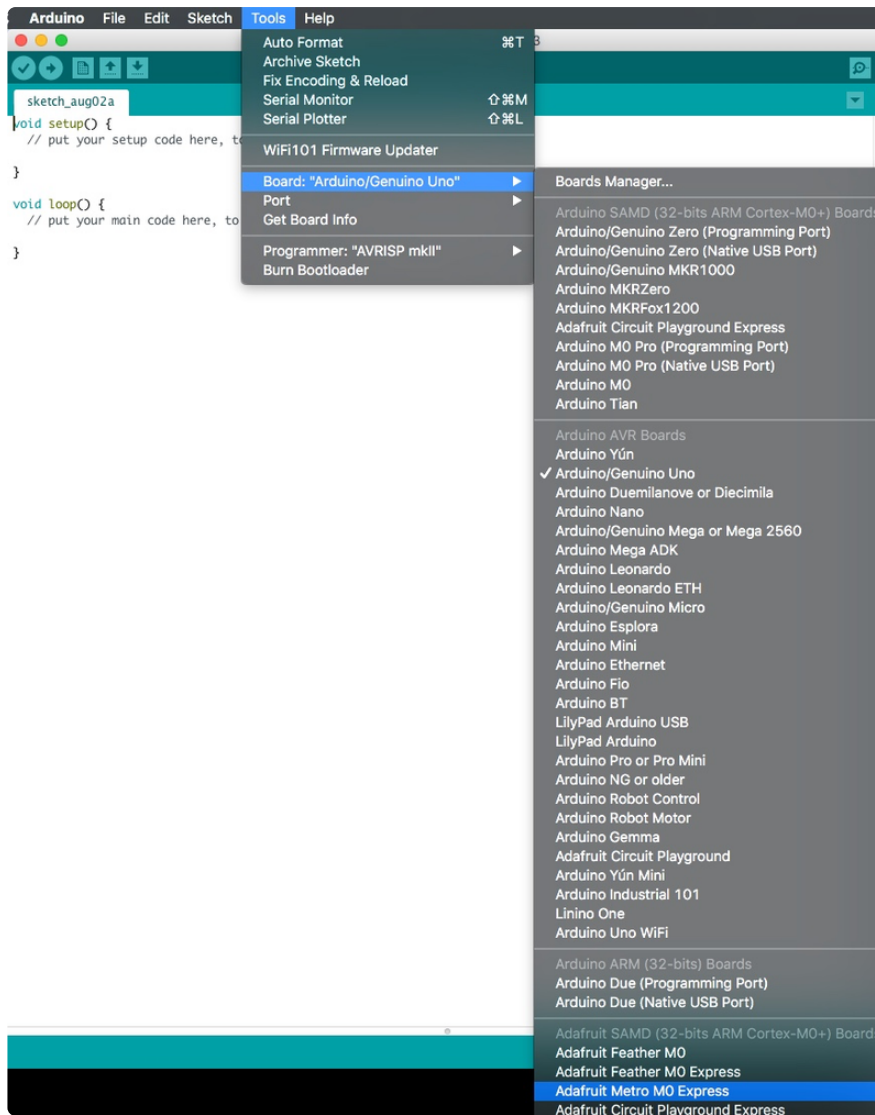

Select the Adafruit Metro M0 Express from the dropdown.

CIRC01: Blinking LED

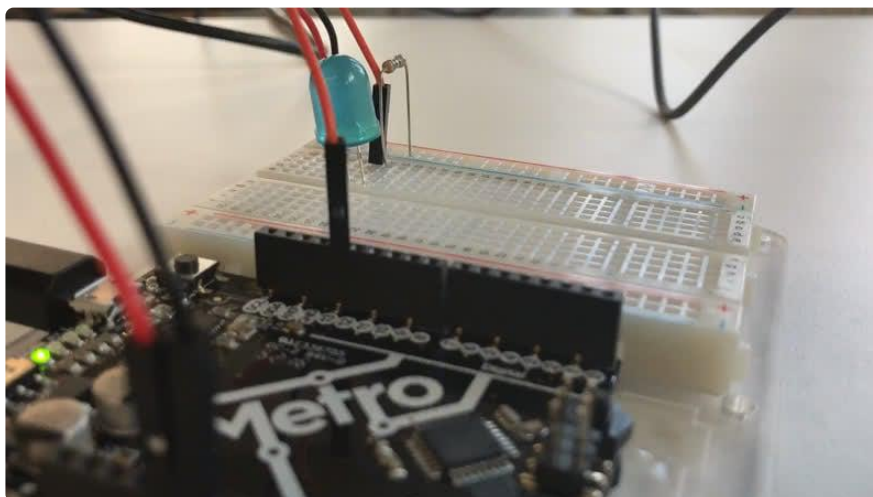

What We're Doing

LEDs (light emitting diodes) are used in all sorts of clever things which is why we have included them in this guide. We will start off with something very simple, turning one on and off, repeatedly, producing a pleasant blinking effect. To get started, grab the parts from the parts page and then plug everything in according to the layout diagram.

Parts

Let's begin by gathering our parts:

Make sure you're using the BLUE LED and not the IR LED.

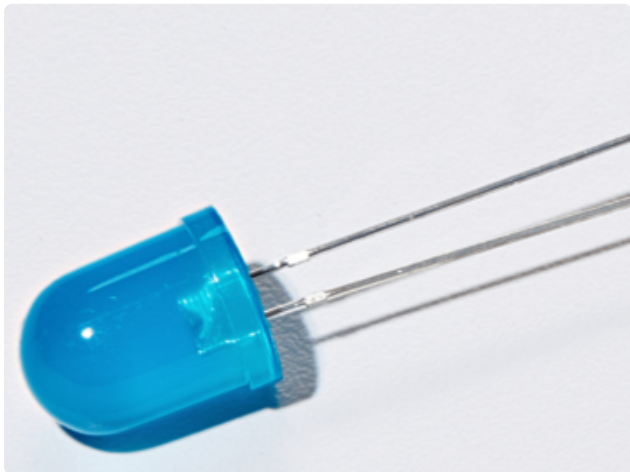

10mm Blue LED

If you'd like to order more of these 10mm LEDs from the Adafruit shop [click here!](#) ()



560 Ohm Resistor

Colors: Green > Blue > Brown

If you'd like to order more resistors from the Adafruit shop [click here!](#) (they are 470ohm but they'll be fine) ()

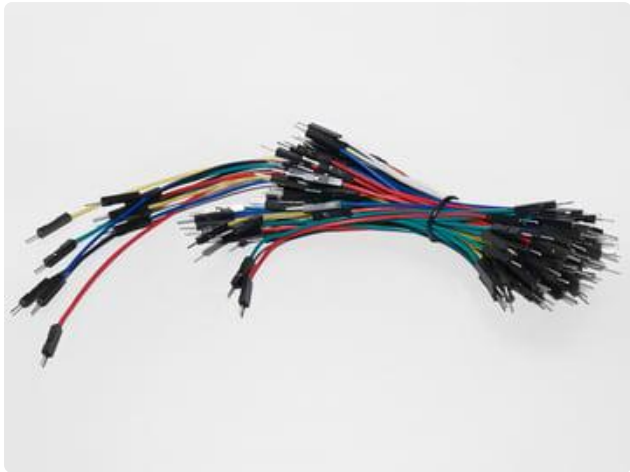

Breadboard Wiring Bundle

If you'd like to order more wires from the Adafruit shop click [here!](#) ()

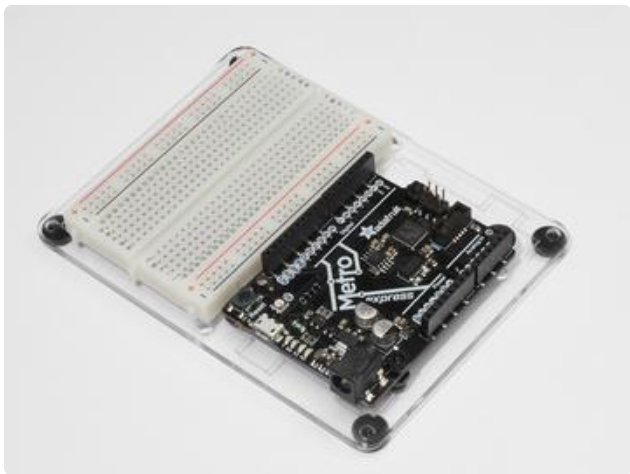

Adafruit Metro (or Metro Express) + Breadboard + Mounting Plate
If you have not assembled this, we have a [handy guide!](#) ()

If you'd like to order an extra plastic mounting plate (), Adafruit Metro (), Adafruit Metro Express (), or [Mini-Breadboard](#) () from the Adafruit Shop click [here!](#)

Wiring

Breadboard Layout

Connect your parts to your breadboard as shown below.

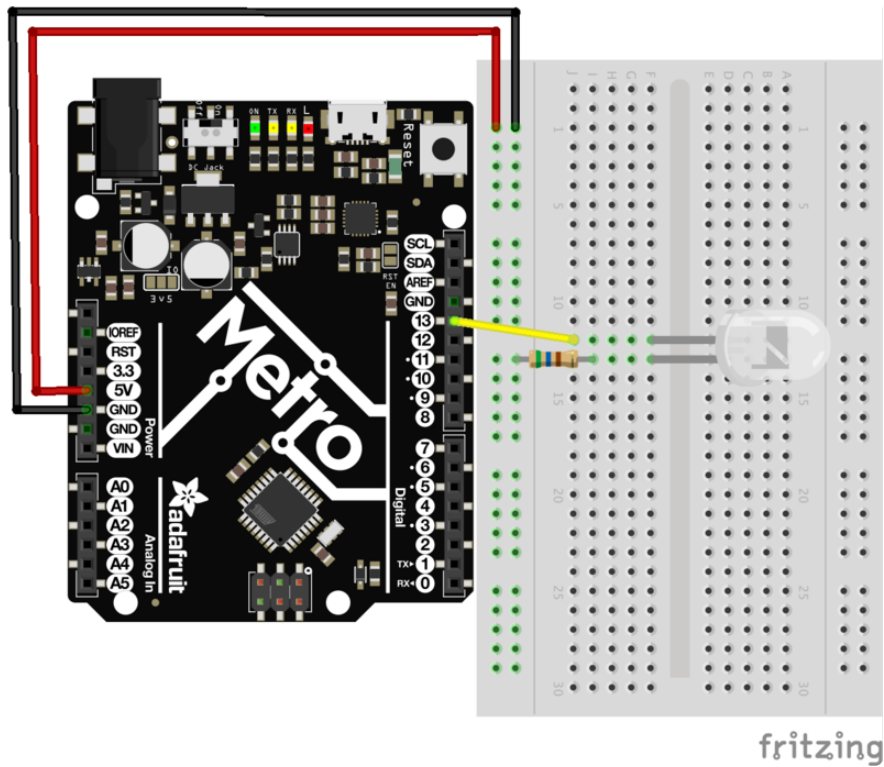

Steps

1. Connect the longer leg of the LED to Pin 13 on the Metro. The shorter lead should be connected with a resistor to the ground terminal.
2. The Metro is capable of supplying 5V to your breadboard. Use a red wire to connect the 5V Pin on the Metro to the left power rail of the breadboard. Connect the GND Pin of the Metro to the rightmost part of the power rail.
3. Connect one leg of the 560 Ohm resistor to the shorter leg of the resistor. The other leg of this resistor is connected to the rail with the black wire (this will be your ground rail).
4. Your completed circuit should be identical to the layout above. Make sure to verify all connections before moving on.

Breadboard Layout Sheet

Each circuit comes with a printable layout sheet to place on the mini-breadboard. You can hold them down with headers (or tape) like this:

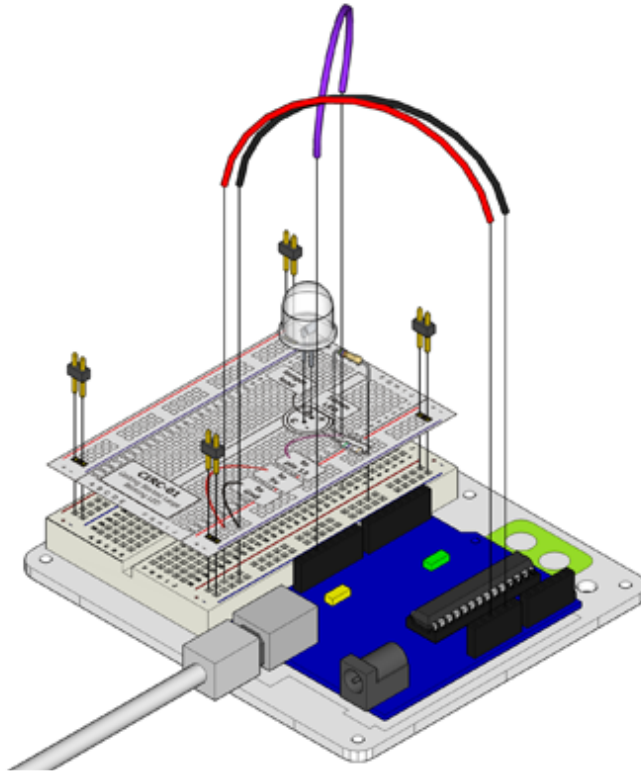

Click here to download the printable Breadboard Layout Sheet for CIRC01

Code

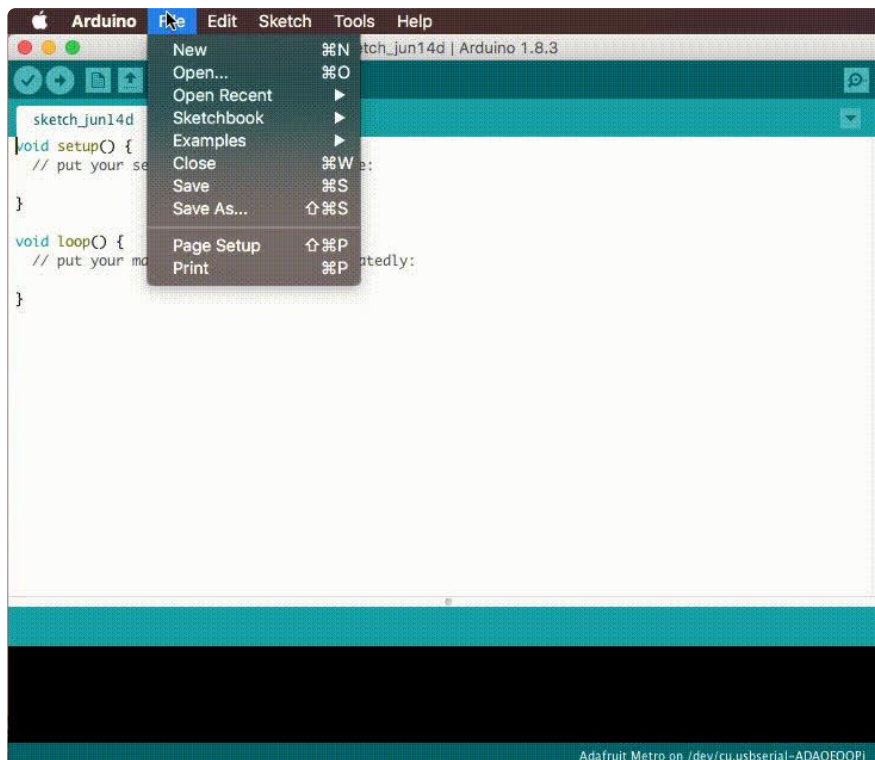

The Arduino Editor provides a great example for blinking a LED. There's no need to type anything, just click in the following in the Arduino Editor: File > Examples > 1.Basic > Blink



Next, we want Arduino to know what Board is being used currently. To do this, navigate to Tools > Board > Arduino/Genuino Uno



Lastly, we need to upload the program. To do this plug the Metro board into your USB port. Then select the proper port in Tools > Serial Port > (the Serial/COM port of your metro). Next upload the program by going to Sketch > Upload (or press ctrl+u on your keyboard)

After uploading to the Metro, you should see the LED on both the Metro and the breadboard blinking.

Blink

If you have trouble loading the Blink Sketch from Arduino's examples, you can copy and paste the code below into the editor.

```

/*
  Blink
  Turns on an LED on for one second, then off for one second, repeatedly.

  Most Arduinos have an on-board LED you can control. On the UNO, MEGA and ZERO
  it is attached to digital pin 13, on MKR1000 on pin 6. LED_BUILTIN is set to
  the correct LED pin independent of which board is used.
  If you want to know what pin the on-board LED is connected to on your Arduino
  model, check
  the Technical Specs of your board at https://www.arduino.cc/en/Main/Products

  This example code is in the public domain.

  modified 8 May 2014
  by Scott Fitzgerald

  modified 2 Sep 2016
  by Arturo Guadalupi

  modified 8 Sep 2016
  by Colby Newman
*/

// the setup function runs once when you press reset or power the board
void setup() {
  // initialize digital pin LED_BUILTIN as an output.
  pinMode(LED_BUILTIN, OUTPUT);
}

// the loop function runs over and over again forever
void loop() {
  digitalWrite(LED_BUILTIN, HIGH); // turn the LED on (HIGH is the voltage level)
  delay(1000); // wait for a second
  digitalWrite(LED_BUILTIN, LOW); // turn the LED off by making the voltage LOW
  delay(1000); // wait for a second
}

```

Having issues with CIRC01?

LED Not Lighting Up?

LEDs will only work in one direction. Try taking it out and twisting it 180 degrees. (no need to worry, installing it backwards does no permanent harm).

Program Not Uploading?

This happens sometimes, the most likely cause is a confused serial port, you can change this in tools>serial port>

Still No Success?

[A broken circuit is no fun, post up in the Adafruit Support Forums and we will get back to you as soon as we can. \(\)](#)

Make It Better

Congrats on building your first circuit with the Adafruit Metro!

Let's play around to make your circuit better and learn some more tricks/tips that will be useful later on.

Change the pin

The LED is connected to pin 13 but we can use any of the METRO's pins. To change it take the wire plugged into pin 13 and move it to a pin of your choice (from 0- 13)

You can also use analog 0-5, Analog #0 is 14, Analog #1 is 15, etc.

Then in the code change all occurrences of `LED_BUILTIN` -> newpin. That is, change every `LED_BUILTIN` to `8`

Then Upload the sketch: by pressing ctrl+u

Change the Blink time

Unhappy with one second on one second off? In the code change the lines:

```
digitalWrite(LED_BUILTIN, HIGH);  
delay(time on); //(seconds * 1000)  
digitalWrite(LED_BUILTIN, LOW);  
delay(time off); //(seconds * 1000)
```

Control the brightness

Along with digital (on/off) control the METRO can control some pins in an analog (brightness) fashion. (more details on this in later circuits). To play around with it. Change the LED to pin 9: (also change the wire) by replacing all `LED_BUILTIN` with `9`

Replace the code inside the `{ }`'s of `loop()` with the following line:

```
analogWrite(9, new number);
```

Note that in the line above,

`new number` is any number between 0 and 255. 0 turns the LED completely off. 255 is the maximum brightness of the LED. Anything between 0 and 255 is a varying brightness. Play around and find one that you like.

Fading

We will use another included example program. To open go to File > Examples > 3.Analog > Fading

Then upload to your board and watch as the LED fades in and then out.

CIRC02: 8 LED Fun

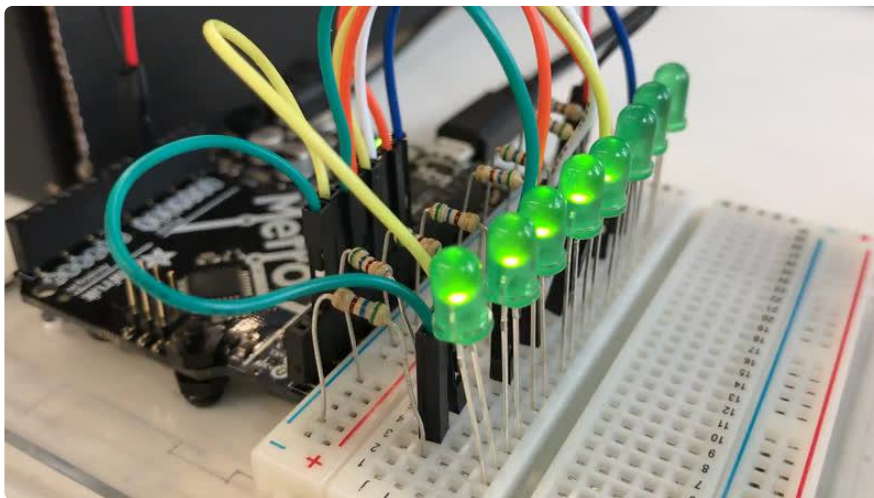

What We're Doing

We have caused one LED to blink, now it's time to up the stakes. Lets connect eight. We'll also have an opportunity to stretch the Metro a bit by creating various lighting sequences. This circuit is also a nice setup to experiment with writing your own programs and getting a feel for how the Metro works.

Along with controlling the LEDs we start looking into a few simple programming methods to keep your programs small: `for()` loops and `array[]`'s

Parts



5mm Green LED
x8 (You'll need 8 of these for CIRC02)

If you'd like to order extra green LEDs from the Adafruit shop, [click here!](#) ()



560 Ohm Resistor
x8 (You'll need 8 of these for CIRC02)

(These are the same resistors that you used in CIRC01, the colors go from: Green > Blue > Brown)

If you'd like to order more resistors from the Adafruit shop [click here!](#) (they are 470ohm but they'll be fine) ()



Breadboard Wiring Bundle

If you'd like to order more wires from the Adafruit shop [click here!](#) ()

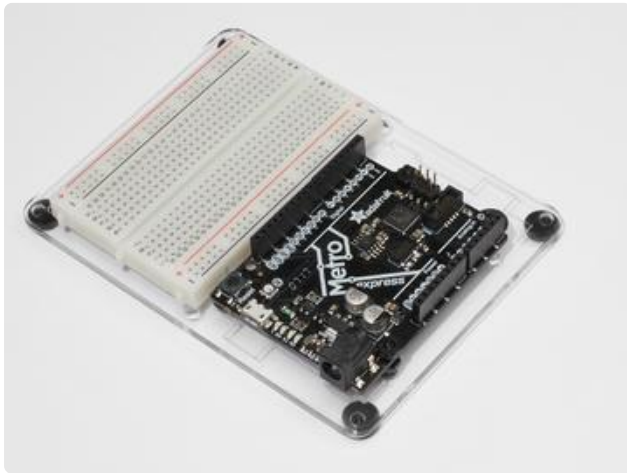

Adafruit Metro (or Metro Express) + Breadboard + Mounting Plate
If you have not assembled this, we have a [handy guide!](#) ()

If you'd like to order an extra plastic mounting plate (), Adafruit Metro (), Adafruit Metro Express (), or Mini-Breadboard () from the Adafruit Shop click [here!](#)

Wiring

Breadboard Layout

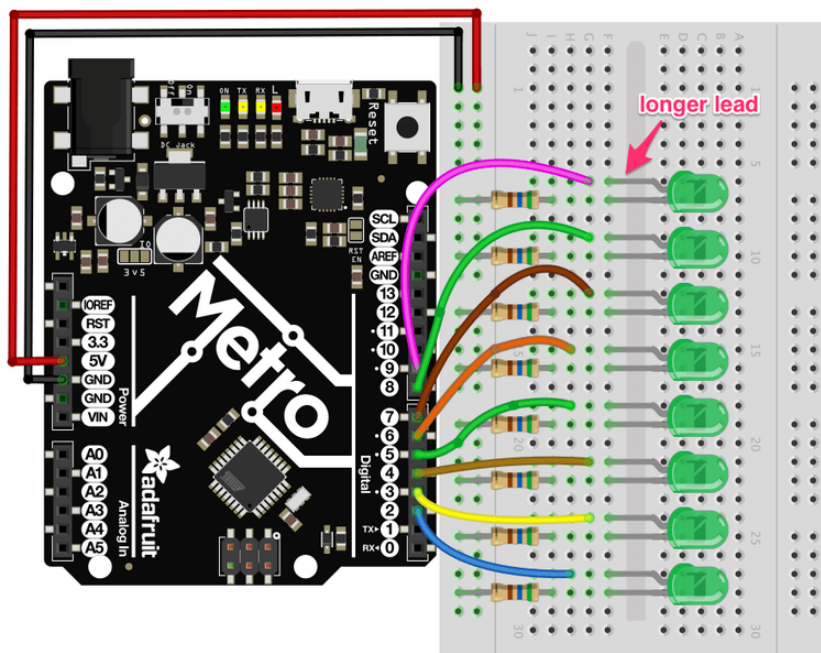

Steps

1. First, connect the 8 Green LEDs to the breadboard. It's useful to space them one hole apart as shown in the layout picture.
2. Next, starting with the green LED at the bottom, connect the longer side of the green LED to a digital pin on the metro. Start with Pin 2 and work your way up until Pin 9. (tip: use different color wires to color-code your LEDs)

3. Then, connect the 8 (560ohm) resistors to the shorter side of the LED.
4. The Metro is capable of supplying 5V to your breadboard. Use a red wire to connect the 5V Pin on the Metro to the left power rail of the breadboard. Connect the GND Pin of the Metro to the rightmost part of the power rail.
5. Your completed circuit should be identical to the layout above. Make sure to verify all connections before moving on.

Click here to download the printable
Breadboard Layout Sheet for
CIRC02

Code

The CIRC02 code is not one of the default Arduino sketches. To use it, copy the code from below and paste it into a new Arduino Sketch (ctrl+n/command+n)

```
/*
 * | Arduino Experimentation Kit Example Code |
 * | CIRC-02 :: 8 LED Fun :: (Multiple LEDs) |
 * |-----|
 *
 * A few Simple LED animations
 *
 * For more information on this circuit http://tinyurl.com/d2hrud
 *
 */

//LED Pin Variables
int ledPins[] = {2,3,4,5,6,7,8,9}; //An array to hold the pin each LED is connected
to
//i.e. LED #0 is connected to pin 2, LED #1, 3
and so on
//to address an array use ledPins[0] this would
equal 2
//and ledPins[7] would equal 9

/*
 * setup() - this function runs once when you turn your Arduino on
 * We the three control pins to outputs
 */
void setup()
{
    //Set each pin connected to an LED to output mode (pulling high (on) or low (off)
    for(int i = 0; i < 8; i++){ //this is a loop and will repeat eight times
        pinMode(ledPins[i],OUTPUT); //we use this to set each LED pin to output
    } //the code this replaces is below

    /* (commented code will not run)
     * these are the lines replaced by the for loop above they do exactly the
     * same thing the one above just uses less typing
    pinMode(ledPins[0],OUTPUT);
    pinMode(ledPins[1],OUTPUT);
    pinMode(ledPins[2],OUTPUT);
    pinMode(ledPins[3],OUTPUT);
    pinMode(ledPins[4],OUTPUT);
    pinMode(ledPins[5],OUTPUT);
    */
}
```

```

pinMode(ledPins[6],OUTPUT);
pinMode(ledPins[7],OUTPUT);
(end of commented code)*/
}

/*
 * loop() - this function will start after setup finishes and then repeat
 * we call a function called oneAfterAnother(). if you would like a different
behaviour
 * uncomment (delete the two slashes) one of the other lines
 */
void loop() // run over and over again
{
  oneAfterAnotherNoLoop(); //this will turn on each LED one by one then turn each
off
  //oneAfterAnotherLoop(); //does the same as oneAfterAnotherNoLoop but with
//much less typing
  //oneOnAtATime(); //this will turn one LED on then turn the next one
//on turning the
//former off (one LED will look like it is scrolling
//along the line
  //inAndOut(); //lights the two middle LEDs then moves them out then
back
  //in again
}

/*
 * oneAfterAnotherNoLoop() - Will light one LED then delay for delayTime then light
 * the next LED until all LEDs are on it will then turn them off one after another
 *
 * this does it without using a loop which makes for a lot of typing.
 * oneOnAtATimeLoop() does exactly the same thing with less typing
 */
void oneAfterAnotherNoLoop(){
  int delayTime = 100; //the time (in milliseconds) to pause between LEDs
  //make smaller for quicker switching and larger for slower
  digitalWrite(ledPins[0], HIGH); //Turns on LED #0 (connected to pin 2 )
  delay(delayTime); //waits delayTime milliseconds
  digitalWrite(ledPins[1], HIGH); //Turns on LED #1 (connected to pin 3 )
  delay(delayTime); //waits delayTime milliseconds
  digitalWrite(ledPins[2], HIGH); //Turns on LED #2 (connected to pin 4 )
  delay(delayTime); //waits delayTime milliseconds
  digitalWrite(ledPins[3], HIGH); //Turns on LED #3 (connected to pin 5 )
  delay(delayTime); //waits delayTime milliseconds
  digitalWrite(ledPins[4], HIGH); //Turns on LED #4 (connected to pin 6 )
  delay(delayTime); //waits delayTime milliseconds
  digitalWrite(ledPins[5], HIGH); //Turns on LED #5 (connected to pin 7 )
  delay(delayTime); //waits delayTime milliseconds
  digitalWrite(ledPins[6], HIGH); //Turns on LED #6 (connected to pin 8 )
  delay(delayTime); //waits delayTime milliseconds
  digitalWrite(ledPins[7], HIGH); //Turns on LED #7 (connected to pin 9 )
  delay(delayTime); //waits delayTime milliseconds

//Turns Each LED Off
  digitalWrite(ledPins[7], LOW); //Turns on LED #0 (connected to pin 2 )
  delay(delayTime); //waits delayTime milliseconds
  digitalWrite(ledPins[6], LOW); //Turns on LED #1 (connected to pin 3 )
  delay(delayTime); //waits delayTime milliseconds
  digitalWrite(ledPins[5], LOW); //Turns on LED #2 (connected to pin 4 )
  delay(delayTime); //waits delayTime milliseconds
  digitalWrite(ledPins[4], LOW); //Turns on LED #3 (connected to pin 5 )
  delay(delayTime); //waits delayTime milliseconds
  digitalWrite(ledPins[3], LOW); //Turns on LED #4 (connected to pin 6 )
  delay(delayTime); //waits delayTime milliseconds
  digitalWrite(ledPins[2], LOW); //Turns on LED #5 (connected to pin 7 )
  delay(delayTime); //waits delayTime milliseconds
  digitalWrite(ledPins[1], LOW); //Turns on LED #6 (connected to pin 8 )
  delay(delayTime); //waits delayTime milliseconds
}

```

```

digitalWrite(ledPins[0], LOW); //Turns on LED #7 (connected to pin 9 )
delay(delayTime);           //waits delayTime milliseconds
}

/*
 * oneAfterAnotherLoop() - Will light one LED then delay for delayTime then light
 * the next LED until all LEDs are on it will then turn them off one after another
 *
 * this does it using a loop which makes for a lot less typing.
 * than oneOnAtATimeNoLoop() does exactly the same thing with less typing
 */
void oneAfterAnotherLoop(){
    int delayTime = 100; //the time (in milliseconds) to pause between LEDs
                        //make smaller for quicker switching and larger for slower

//Turn Each LED on one after another
    for(int i = 0; i <= 7; i++){
        digitalWrite(ledPins[i], HIGH); //Turns on LED #i each time this runs i
        delay(delayTime);                //gets one added to it so this will repeat
    }                                     //8 times the first time i will = 0 the final
                                        //time i will equal 7;

//Turn Each LED off one after another
    for(int i = 7; i >= 0; i--){ //same as above but rather than starting at 0 and
counting up
        //we start at seven and count down
        digitalWrite(ledPins[i], LOW); //Turns off LED #i each time this runs i
        delay(delayTime);                //gets one subtracted from it so this will
repeat
    }                                     //8 times the first time i will = 7 the final
                                        //time it will equal 0

}

/*
 * oneOnAtATime() - Will light one LED then the next turning off all the others
 */
void oneOnAtATime(){
    int delayTime = 100; //the time (in milliseconds) to pause between LEDs
                        //make smaller for quicker switching and larger for slower

    for(int i = 0; i <= 7; i++){
        int offLED = i - 1; //Calculate which LED was turned on last time through
        if(i == 0) {        //for i = 1 to 7 this is i minus 1 (i.e. if i = 2 we will
            offLED = 7;     //turn on LED 2 and off LED 1)
        }                   //however if i = 0 we don't want to turn of led -1
(doesn't exist)
        //instead we turn off LED 7, (looping around)
        digitalWrite(ledPins[i], HIGH); //turn on LED #i
        digitalWrite(ledPins[offLED], LOW); //turn off the LED we turned on last time
        delay(delayTime);
    }
}

/*
 * inAndOut() - This will turn on the two middle LEDs then the next two out
 * making an in and out look
 */
void inAndOut(){
    int delayTime = 100; //the time (in milliseconds) to pause between LEDs
                        //make smaller for quicker switching and larger for slower

//runs the LEDs out from the middle
    for(int i = 0; i <= 3; i++){
        int offLED = i - 1; //Calculate which LED was turned on last time through
        if(i == 0) {        //for i = 1 to 7 this is i minus 1 (i.e. if i = 2 we will
            offLED = 3;     //turn on LED 2 and off LED 1)
        }                   //however if i = 0 we don't want to turn of led -1
    }
}

```



```

(doesn't exist)
    int onLED1 = 3 - i; //instead we turn off LED 7, (looping around)
    //this is the first LED to go on ie. LED #3 when i =
0 and LED
    int onLED2 = 4 + i; //this is the first LED to go on ie. LED #4 when i =
0 and LED
    //turn off the LED we turned on last time
    int offLED1 = 3 - offLED; //turns off the LED we turned on last time
    int offLED2 = 4 + offLED; //turns off the LED we turned on last time

    digitalWrite(ledPins[onLED1], HIGH);
    digitalWrite(ledPins[onLED2], HIGH);
    digitalWrite(ledPins[offLED1], LOW);
    digitalWrite(ledPins[offLED2], LOW);
    delay(delayTime);
}

//runs the LEDs into the middle
for(int i = 3; i >= 0; i--){
    int offLED = i + 1; //Calculate which LED was turned on last time through
    if(i == 3) { //for i = 1 to 7 this is i minus 1 (i.e. if i = 2 we will
        offLED = 0; //turn on LED 2 and off LED 1)
    } //however if i = 0 we don't want to turn of led -1
(doesn't exist)
    int onLED1 = 3 - i; //instead we turn off LED 7, (looping around)
    //this is the first LED to go on ie. LED #3 when i =
0 and LED
    int onLED2 = 4 + i; //this is the first LED to go on ie. LED #4 when i =
0 and LED
    //turn off the LED we turned on last time
    int offLED1 = 3 - offLED; //turns off the LED we turned on last time
    int offLED2 = 4 + offLED; //turns off the LED we turned on last time

    digitalWrite(ledPins[onLED1], HIGH);
    digitalWrite(ledPins[onLED2], HIGH);
    digitalWrite(ledPins[offLED1], LOW);
    digitalWrite(ledPins[offLED2], LOW);
    delay(delayTime);
}
}
}

```

Not working? Try again with a fresh slate!

Its easy to accidentally misplace a wire without noticing. Pulling everything out and starting with a fresh slate is often easier than trying to track down the problem.

Still not working?

We'll help you out! [Post up in the Adafruit Support Forums](#) and we will get back to you as soon as we can. ()

Make It Better

Switching to Loops

Bored of watching the light show? Want to make your own animation, change the animation, or learn about looping functions? Let's make CIRC02 better!

In the `void loop()` procedure, there are 4 lines. The last three all start with a `//`. This means the line is a comment (it won't run). We can switch the program to use loops by deleting the comments (If you want to learn more about comments, [we have a great writeup](#) (!)).

First, inside `void loop()`, add slashes to disable the `oneAfterAnotherNoLoop()` procedure from running:

```
oneAfterAnotherNoLoop(); -> //oneAfterAnotherNoLoop();
```

Next, we are going to delete comments (slashes) to enable the `oneAfterAnotherLoop()` procedure to run with loops:

```
//oneAfterAnotherLoop(); -> oneAfterAnotherLoop();
```

We should verify that our code compiles correctly now, click the check mark (or, ctrl/command+r). If everything compiles with no errors, go ahead and Upload (ctrl+u) the new program to your metro.

After running the program, what changed?

There was no change! Both procedures run the same animation. (click to reveal the answer)

What's the difference between the two procedures: `oneAfterAnotherNoLoop()` and `oneAfterAnotherLoop()`?

`oneAfterAnotherNoLoop()` runs the animation without using a loop which makes for a lot of typing. Using `oneAfterAnotherLoop()` will require less typing to run the same animation! (click to reveal the answer)

Extra Animations

Tired of this animation? There are more animations for you to play around with!

To enable them, uncomment (just delete the `//`) row 3 and row 4 so that:

```
//oneOnAtATime(); -> oneOnAtATime();
```

```
//inAndOut(); -> inAndOut();
```

Then Upload the program (ctrl+u) to your board and enjoy the new light animations.

Make your own animations

Go ahead and jump into the included code and start changing things around.

To tell the Metro to turn a LED on,

```
digitalWrite(pinNumber, HIGH);
```

If you want to tell the Metro to turn a LED off,

```
digitalWrite(pinNumber, LOW);
```

Type away! Regardless of what you change you won't break anything.

CIRC03: Spin Motor Spin

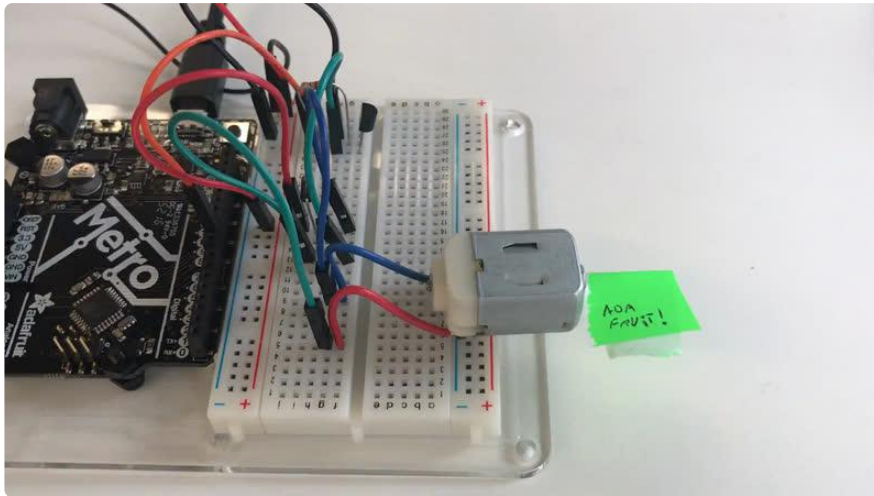

What We're Doing

The Metro's pins are great for directly controlling small electric items like LEDs. However, when dealing with larger items (like a toy motor or washing machine), an external transistor is required.

A transistor is incredibly useful. It switches a lot of current using a much smaller current. A transistor has 3 pins. For a negative type (NPN) transistor, you connect your load to collector and the emitter to ground. Then, when a small current flows from base to the emitter, a current will flow through the transistor and your motor will spin (this happens when we set our Metro pins high). [For a more in-depth explanation about transistors, click here \(\)](#).

There are literally thousands of different types of transistors, allowing every situation to be perfectly matched. We have chosen a P2N2222, a rather common general purpose transistor. The important factors in our case are that its maximum voltage (40 v) and its maximum current (600 milliamp) are both high enough for our toy motor ([full details can be found on its datasheet \(\)](#)).

Parts



DC Toy/Hobby Motor

If you'd like to order another DC Motor from the Adafruit shop, [click here!](#) ()



Transistor (PN2222 or MPS2222)

If you'd like to order extra NPN transistors from the Adafruit shop, [click here!](#) ()



2.2k Ohm Resistor

Colors: Red > Red > Red

If you'd like to order extra 2.2k Ohm resistors from the Adafruit shop, [click here!](#) ()



Diode (1N4001)

If you'd like to order more diodes from the Adafruit shop, [click here!](#) ()



Breadboard Wiring Bundle

If you'd like to order more wires from the Adafruit shop [click here!](#) ()

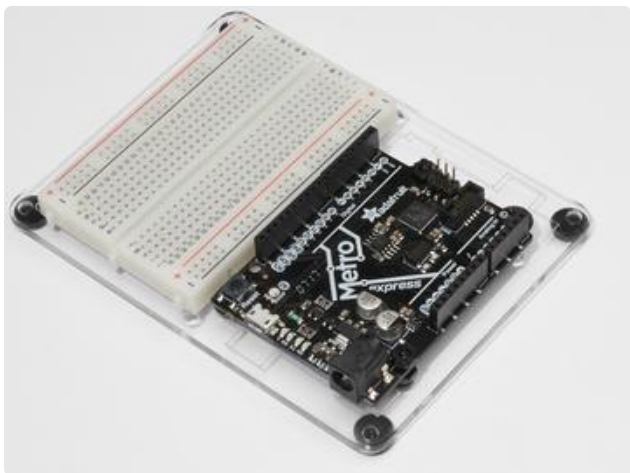

Adafruit Metro (or Metro Express) + Breadboard + Mounting Plate
If you have not assembled this, we have a [handy guide!](#) ()

If you'd like to order an extra plastic mounting plate (), Adafruit Metro (), Adafruit Metro Express (), or Mini-Breadboard () from the Adafruit Shop [click here!](#)

Wiring

The motor that comes with the MetroX kit does not draw more than 250mA but if you have a different motor, it could easily draw 1000mA, more than a USB port

can handle! If you aren't sure of a motor's current draw, power the Metro from a wall adapter, not just USB.

Before beginning CIRC03, you should note the following things:

- The flat side of the transistor should face the Metro.
- The striped side of the diode should be facing towards the bottom of the Metro
- The resistor used in this circuit is different from the past two (CIRC01/CIRC02). Make sure the color bands read red > red > red.

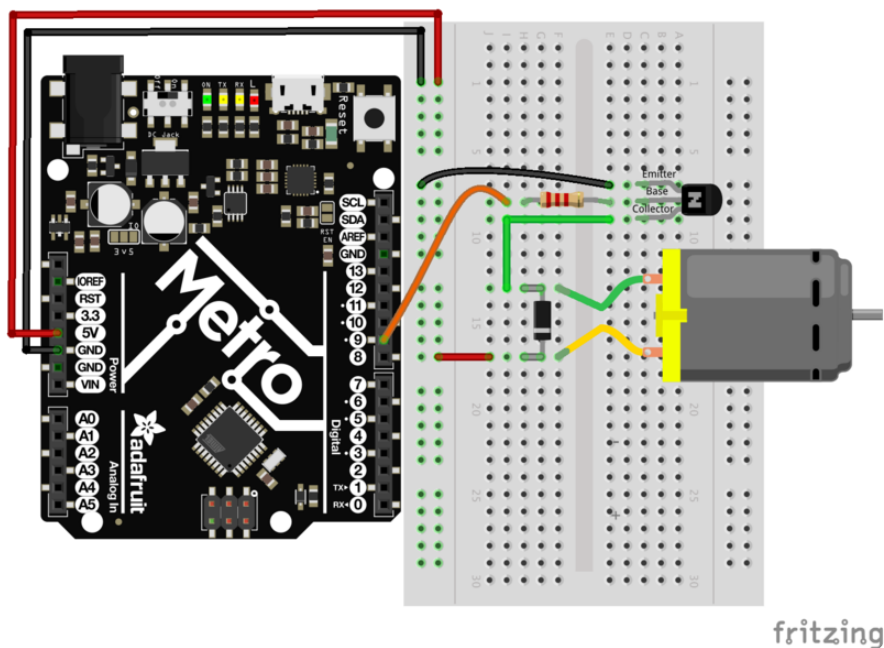

Steps

1. Connect GND and 5V on the Metro to the red and blue power rails.
2. Ensure the flat side of the transistor faces towards the Metro. Connect the Emitter (labeled on the diagram above) to the GND rail. First connect the Base to the 2.2k Ohm resistor, then to the 5V rail. Leave the collector for now.
3. Connect the striped lead of the diode to the 5V rail, and the un-striped lead to the collector of the transistor.
4. The blue motor wire should be connected to the striped diode lead. Connect the red motor wire to the bottom (un-striped) side of the diode.
5. Re-read the notes above the diagram to ensure you did not make any errors while connecting components. It does not matter which way you connect the motor's leads for now.

Click here to download the printable
Breadboard Layout Sheet for
CIRC03

Code

Just like we did in the previous circuit, copy and paste the code into a new Arduino sketch. Then [compile and upload it to your metro](#) ().

```
/*
 * -----
 * | Arduino Experimentation Kit Example Code |
 * | CIRC-03 :: Spin Motor Spin :: (Transistor and Motor) |
 * -----
 *
 * The Arduinos pins are great for driving LEDs however if you hook
 * up something that requires more power you will quickly break them.
 * To control bigger items we need the help of a transistor.
 * Here we will use a transistor to control a small toy motor
 *
 */

int motorPin = 9; // define the pin the motor is connected to
                  // (if you use pin 9,10,11 or 3you can also control speed)

/*
 * setup() - this function runs once when you turn your Arduino on
 * We set the motors pin to be an output (turning the pin high (+5v) or low
 (ground) (-))
 * rather than an input (checking whether a pin is high or low)
 */
void setup()
{
  pinMode(motorPin, OUTPUT);
}

/*
 * loop() - this function will start after setup finishes and then repeat
 * we call a function called motorOnThenOff()
 */

void loop() // run over and over again
{
  motorOnThenOff();
  //motorOnThenOffWithSpeed();
  //motorAcceleration();
}

/*
 * motorOnThenOff() - turns motor on then off
 * (notice this code is identical to the code we used for
 * the blinking LED)
 */
void motorOnThenOff(){
  int onTime = 2500; //the number of milliseconds for the motor to turn on for
  int offTime = 1000; //the number of milliseconds for the motor to turn off for

  digitalWrite(motorPin, HIGH); // turns the motor On
  delay(onTime); // waits for onTime milliseconds
  digitalWrite(motorPin, LOW); // turns the motor Off
}
```

```

    delay(offTime);          // waits for offTime milliseconds
}

/*
 * motorOnThenOffWithSpeed() - turns motor on then off but uses speed values as
well
 * (notice this code is identical to the code we used for
 * the blinking LED)
 */
void motorOnThenOffWithSpeed(){

    int onSpeed = 200; // a number between 0 (stopped) and 255 (full speed)
    int onTime = 2500; //the number of milliseconds for the motor to turn on for

    int offSpeed = 50; // a number between 0 (stopped) and 255 (full speed)
    int offTime = 1000; //the number of milliseconds for the motor to turn off for

    analogWrite(motorPin, onSpeed); // turns the motor On
    delay(onTime); // waits for onTime milliseconds
    analogWrite(motorPin, offSpeed); // turns the motor Off
    delay(offTime); // waits for offTime milliseconds
}

/*
 * motorAcceleration() - accelerates the motor to full speed then
 * back down to zero
 */
void motorAcceleration(){
    int delayTime = 50; //milliseconds between each speed step

    //Accelerates the motor
    for(int i = 0; i < 256; i++){ //goes through each speed from 0 to 255
        analogWrite(motorPin, i); //sets the new speed
        delay(delayTime); // waits for delayTime milliseconds
    }

    //Decelerates the motor
    for(int i = 255; i >= 0; i--){ //goes through each speed from 255 to 0
        analogWrite(motorPin, i); //sets the new speed
        delay(delayTime); // waits for delayTime milliseconds
    }
}
}

```

Having Trouble with CIRC03?

Motor Not Spinning?

If you sourced your own transistor, double check with the data sheet that the pinout is compatible with a PN2222 (many are reversed).

Check Your Motor

If you sourced your own motor, double check that it will work with 5 volts and that it does not draw too much power.

Still having issues?

Sometimes the Metro board will disconnect from the computer. Try un-plugging and then re-plugging it into your USB port.

Tried the steps above? Still didn't resolve your issue?

Have no fear, we'll help you out! [Post up in the Adafruit Support Forums](#) and we will get back to you as soon as we can. ()

Make It Better

Controlling Speed

We played with the Metro's ability to control the brightness of an LED earlier. Now, we will use the same feature to control the speed of our motor.

The Metro does this using something called Pulse Width Modulation (PWM). This relies on the METRO's ability to operate really, really fast. Rather than directly controlling the voltage coming from the pin, the Metro will switch the pin on and off very quickly.

In the computer world this is going from 0 to 5 volts many times a second, but in the human world we see it as a voltage. For example: if the Metro is PWM'ing at 50%, we see the light dimmed 50% because our eyes are not quick enough to see it flashing on and off. The same feature works with transistors. ([if you want a visual explanation of this concept, click here](#) ())

Don't believe me? Try it out!

Copy and paste the code snippet below into the `loop()` function of your code:

```
// motorOnThenOff();  
motorOnThenOffWithSpeed();  
// motorAcceleration();
```

Then Upload the program.

You can change the speeds by changing variables `onSpeed` and `offSpeed` to any number between 0 (stop the motor) and 255 (full power!)

Accelerating and Decelerating

Why stop at two speeds? Why not accelerate and decelerate the motor.

To do this simply change the loop() code to read:

```
// motorOnThenOff();  
// motorOnThenOffWithSpeed();  
motorAcceleration();
```

Then Upload the program and watch as your motor slowly accelerates up to full speed then slows down again.

If you would like to change the speed of acceleration, change the variable `delayTime` (larger means a longer acceleration time) to a different value.

CIRC04: A Single Servo

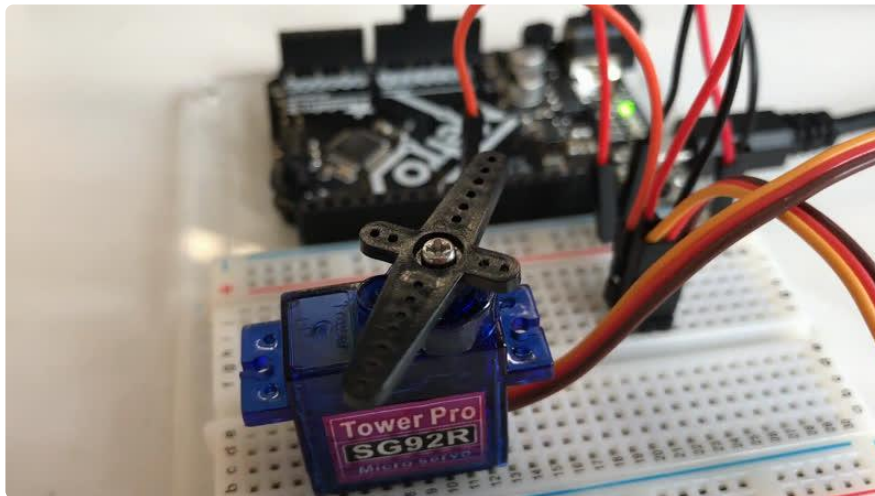

Spinning a motor is good fun but when it comes to projects where motion control is required they tend to leave us wanting more.

The answer? Hobby servos. They are mass produced, widely available and cost anything from a couple of dollars to hundreds.

Inside is a small gearbox (to make the movement more powerful) and some electronics (to make it easier to control). A standard servo is positionable from 0 to 180 degrees.

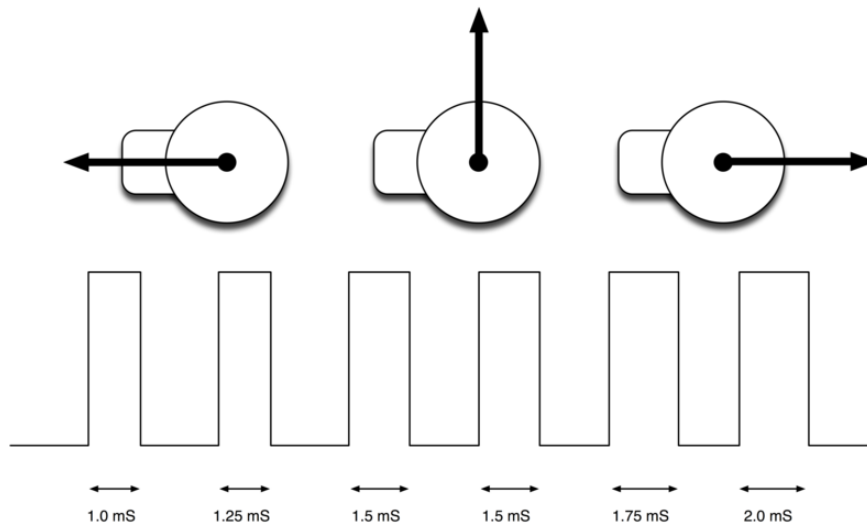

(Servo Positioning picture from Simon Monk's [Arduino Lesson 14. Servo Motors \(\)](#))

Positioning is controlled through a timed pulse, between 1.25 milliseconds (0 degrees) and 1.75 milliseconds (180 degrees) (1.5 milliseconds for 90 degrees). Timing varies between manufacturer. If the pulse is sent every 25-50 milliseconds the servo will run smoothly. One of the great features of the Adafruit Metro is it has a software library which can control servos using a single line of code

Parts

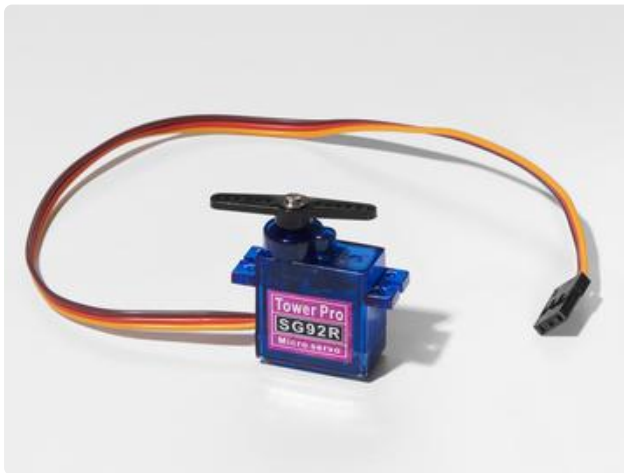

Mini Servo

If you'd like to order an extra mini servo from the Adafruit shop, [click here! \(\)](#)

There are many other servo sizes and types in the Adafruit store, check out our offerings ()

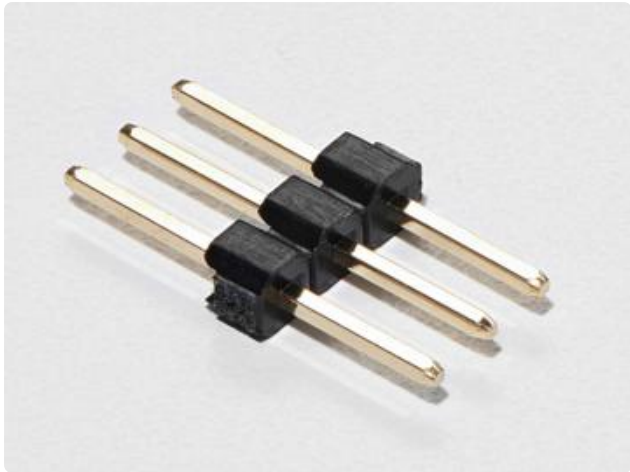

3-Pin Header

If you'd like to order extra headers from the Adafruit shop, click [here!](#) (these are 40-pins but you can break them apart easily) ()



Breadboard Wiring Bundle

If you'd like to order more wires from the Adafruit shop click [here!](#) ()

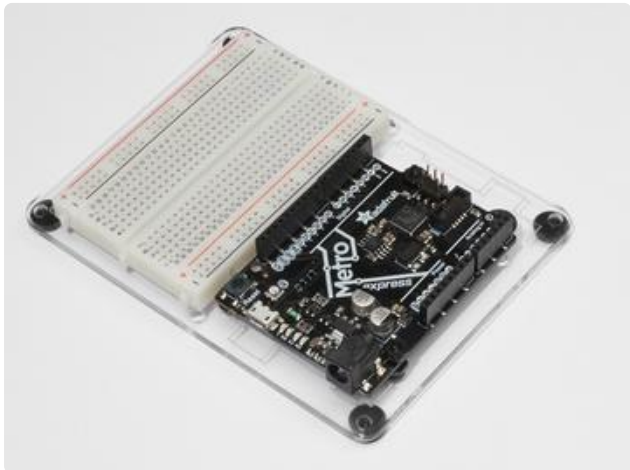

Adafruit Metro (or Metro Express) + Breadboard + Mounting Plate
If you have not assembled this, we have a [handy guide!](#) ()

If you'd like to order an extra plastic mounting plate (), Adafruit Metro (), Adafruit Metro Express (), or Mini-Breadboard () from the Adafruit Shop click [here!](#)

Wiring

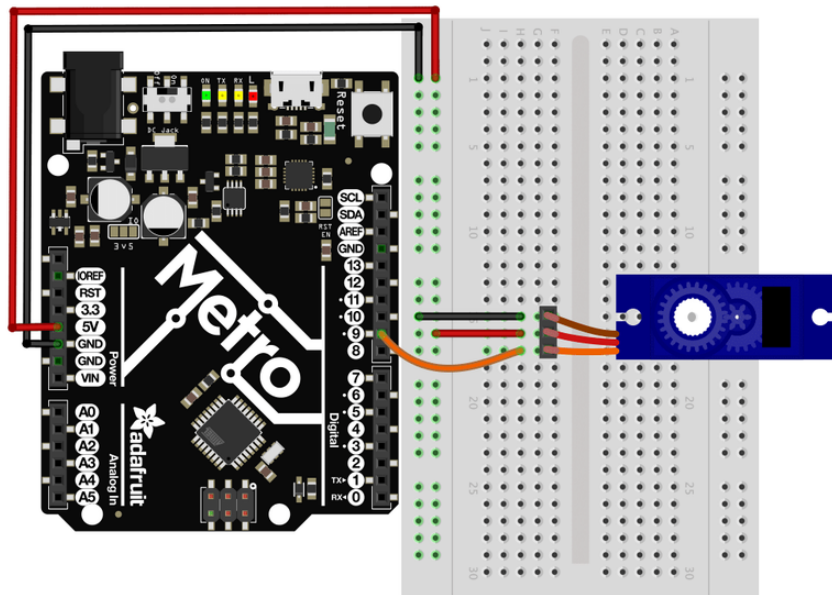

The wiring for CIRC04 is much simpler than the last two circuits you made.

1. Connect the 5V pin on the Metro to the power rail on the breadboard.
2. Connect the GND pin on the Metro to the ground rail on the breadboard.
3. Connect the female end of the servo to the 3-Pin header.
4. Plug the 3-Pin header into any row on the breadboard.
5. Connect the ground rail to the brown servo wire.
6. Connect the power rail to the red servo wire.
7. Connect Metro Pin 9 to the orange servo wire (signal).

If you're having trouble, check the "Connection details" below for wiring help.

Connection details:

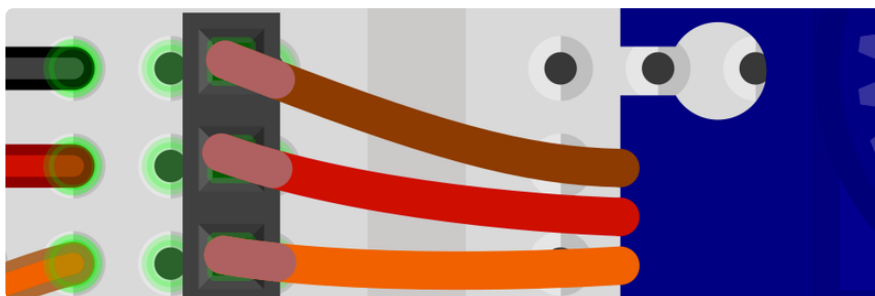

Breadboard

Servo

Ground Rail	Black/Brown (Ground)
Power Rail	Red (+5V)
Metro Pin 9	Orange (Signal)

Breadboard Layout Sheet

Click here to download the printable Breadboard Layout Sheet for CIRC01

Code

The servo code we are going to use is included in Arduino (just like CIRC001) under: File > Examples > Servo > Sweep.

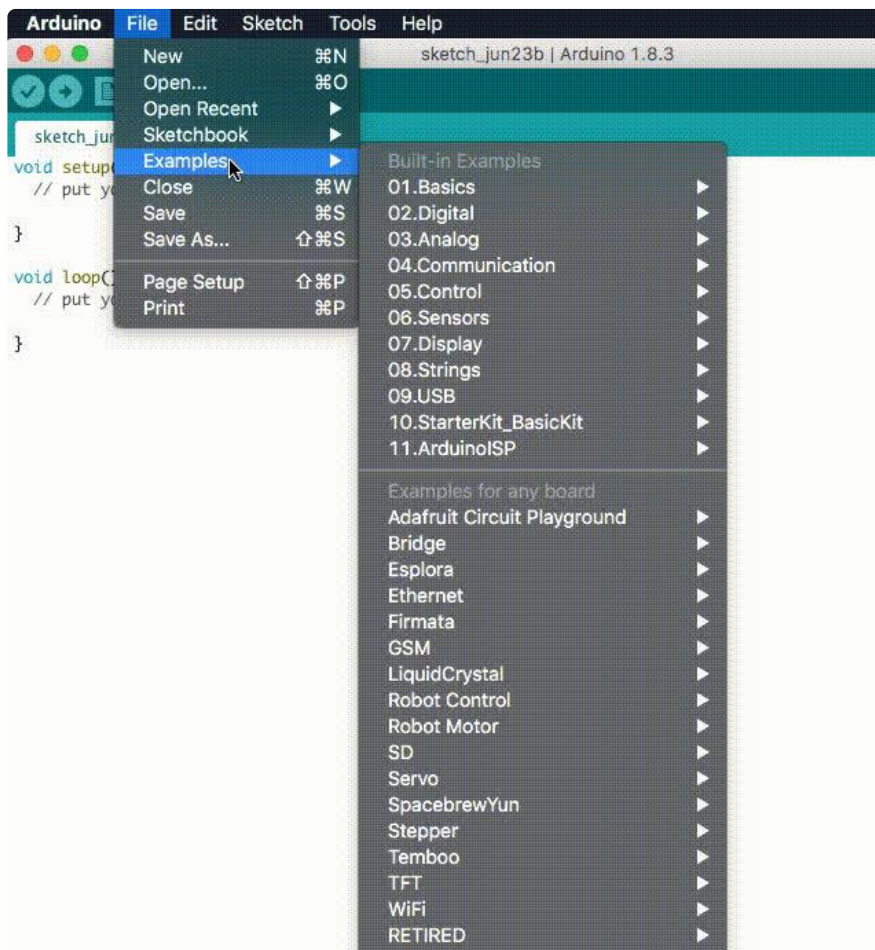

After loading the sketch, [compile and upload it to your metro \(\)](#) and watch the servo move!

Sweep

If you're having trouble loading Sweep from Arduino's included examples, the full source code is below to copy/paste into the Arduino editor.

```
/* Sweep
  by BARRAGAN <http://barraganstudio.com>
  This example code is in the public domain.

  modified 8 Nov 2013
  by Scott Fitzgerald
  http://www.arduino.cc/en/Tutorial/Sweep
  */

#include <Servo.h>

Servo myservo; // create servo object to control a servo
// twelve servo objects can be created on most boards

int pos = 0;    // variable to store the servo position

void setup() {
  myservo.attach(9); // attaches the servo on pin 9 to the servo object
}

void loop() {
  for (pos = 0; pos <= 180; pos += 1) { // goes from 0 degrees to 180 degrees
    // in steps of 1 degree
    myservo.write(pos);              // tell servo to go to position in variable
    'pos'
    delay(15);                       // waits 15ms for the servo to reach the
    position
  }
  for (pos = 180; pos >= 0; pos -= 1) { // goes from 180 degrees to 0 degrees
    myservo.write(pos);              // tell servo to go to position in variable
    'pos'
    delay(15);                       // waits 15ms for the servo to reach the
    position
  }
}
```

Not Working?

Servo Not Twisting?

Even with colored wires it is still shockingly easy to plug a servo in backwards. This might be the case. [Check the connection table if you need help. \(\)](#)

Twitching and a flashing LED on your metro?

If the servo begins moving then twitches, and there's a flashing light on your METRO board, the power supply you are using is not quite up to the challenge. Using a fresh battery instead of USB should solve this problem.

My servo is not moving at all

A mistake we made a time or two was simply forgetting to connect the power (red and brown wires) to +5 volts and ground. Check your connections again for faults.

Nothing is working, I need assistance

We'll help you out! [Post up in the Adafruit Support Forums](#) and we will get back to you as soon as we can. ()

Make It Better

Potentiometer Control

We have yet to experiment with inputs but if you would like to control your motor, a potentiometer is a great choice and the Arduino editor has a example program for it. We are going to learn about the potentiometer in CIRC08, but we can get our feet wet with this type of input by modifying CIRC04.

Parts

You'll only need to add one part to this circuit: the blue trim potentiometer. You can find it in your box:

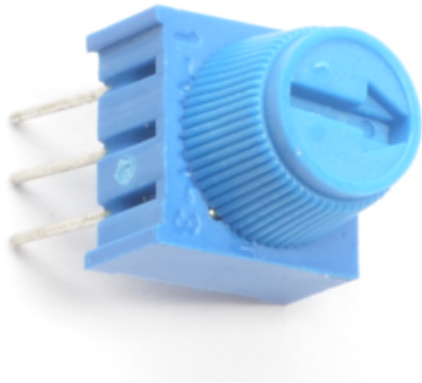

Breadboard Trim Potentiometer - 10k

If you'd like to buy an extra trimpot from the Adafruit store, [click here!](#) ()

Wiring the Potentiometer

Wire it such that the two outermost pins go to the power and ground rail. The inner pin should go to the Metro's analog pin 0. Note that we are using an analog pin instead of a digital pin this time, they are located on the left side of the Metro instead of the right side.

Metro Breadboard Diagram

Be careful - the Trim Potentiometer connects to the 3.3v input on the Metro, not the 5V rail.

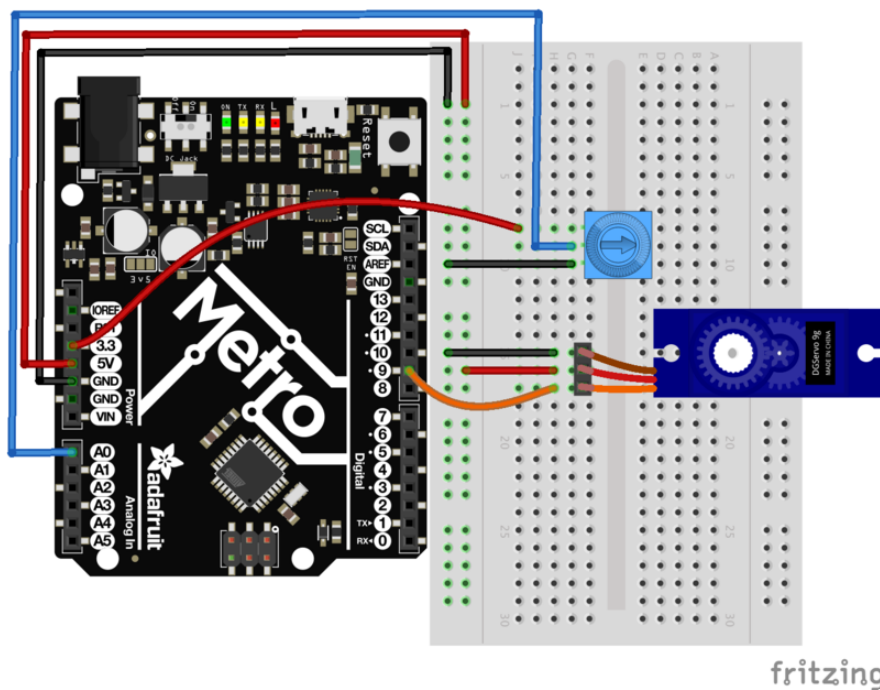

Loading the example code

The code to load potentiometer control onto your revised CIRC04 is provided by Arduino under

File > Servo > Knob. After loading the sketch, [compile and upload it to your metro \(\)](#). Move the potentiometer left and right, you should see the servo move with it.

Self-Timing

While it is easy to control a servo using the Metro's included library, sometimes it is fun to figure out how to program something yourself. Try it! Remember that we're controlling the pulse directly so you could use this method to control servos on any of the Metro's 20 available pins (you need to highly optimize this code before doing that).

Other fun servo ideas

Servos can be used to do all sorts of things. [The Adafruit Learning System is a great resource to find a fun project with servos. \(\)](#)

Here are a few of our favorites:



[Animatronic Servo Tail: Who hasn't imagined having a tail? With a single servo and a little math, we can make this real! \(\)](#)



Have you ever wanted to build a robot, but don't know where to start? Or... are you looking for a project that you can cut-your-teeth on? ()

This servo-controlled animatronic robot head uses two servos for movement, two speakers for eyes and an LED mouth for a friendly remote-controlled robot. ()

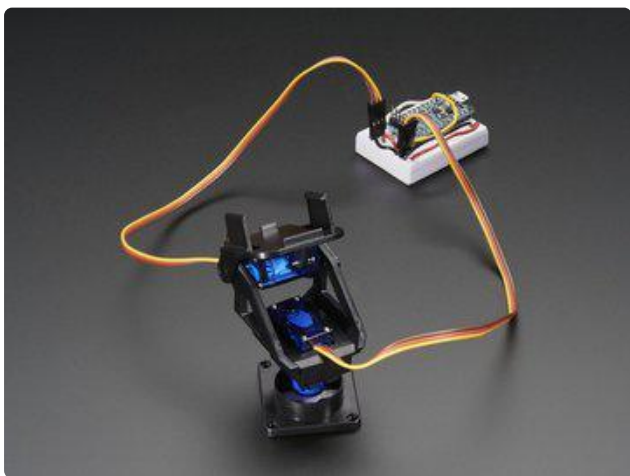

Our fully-assembled pan-tilt kit is the perfect way to give your project full range motion with two micro servos. The pan-tilt can rotate roughly 180° from side-to-side and can tilt up&downwards around 150°. It also comes fully assembled with two Micro Servos (SG-90 or SG-92 type) included and a 38mm x 36mm space to mount a camera or sensor or whatever you like. ()



Sandblaster is a variation on Blue Buggy remixing the original Cox International gas-powered sand buggy - scaled-down, converted to electric, and 3D printable! ()

You can use it to explore obstacle avoidance, autonomous navigation, driverless vehicle design, or assisted Remote Control. Or... build in the morning and race in the afternoon! ()

Crazy fun for your local hackerspace / makerspace or family night! ()

CIRC05: 8 More LEDs

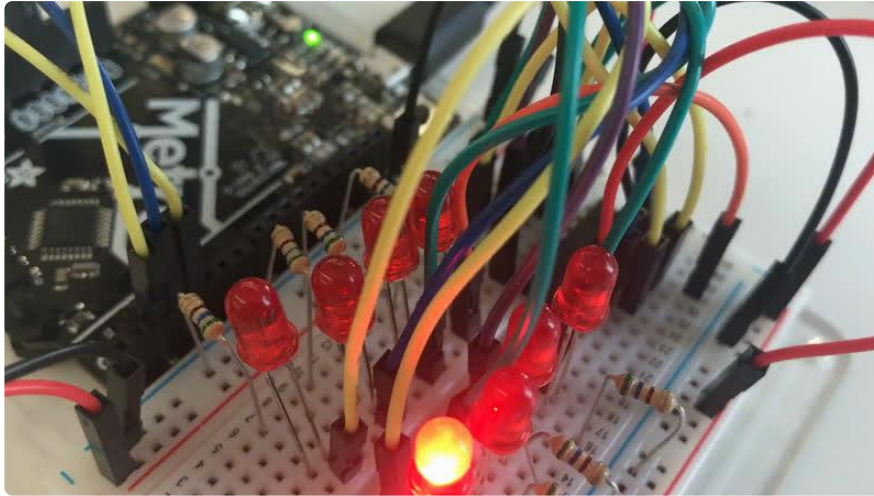

Time to start playing with chips, or integrated circuits (ICs) as they like to be called. The external packaging of a chip can be very deceptive. For example, the chip on the Metro board (a microcontroller) and the one we will use in this circuit (a shift register) look very similar but are in fact rather different. The price of the Atmel 328p chip on the Metro board is a few dollars while the 74HC595 is a couple dozen cents. It's a good introductory chip, and once you're comfortable playing around with it and its [datasheet](#) (), the world of chips will be your oyster.

The shift register (also called a serial to parallel converter), will give you an additional 8 outputs (to control LEDs and the like) using only three Metro pins. They can also be linked together to give you a nearly unlimited number of outputs using the same four pins. To use it you “clock in” the data and then lock it in (latch it).

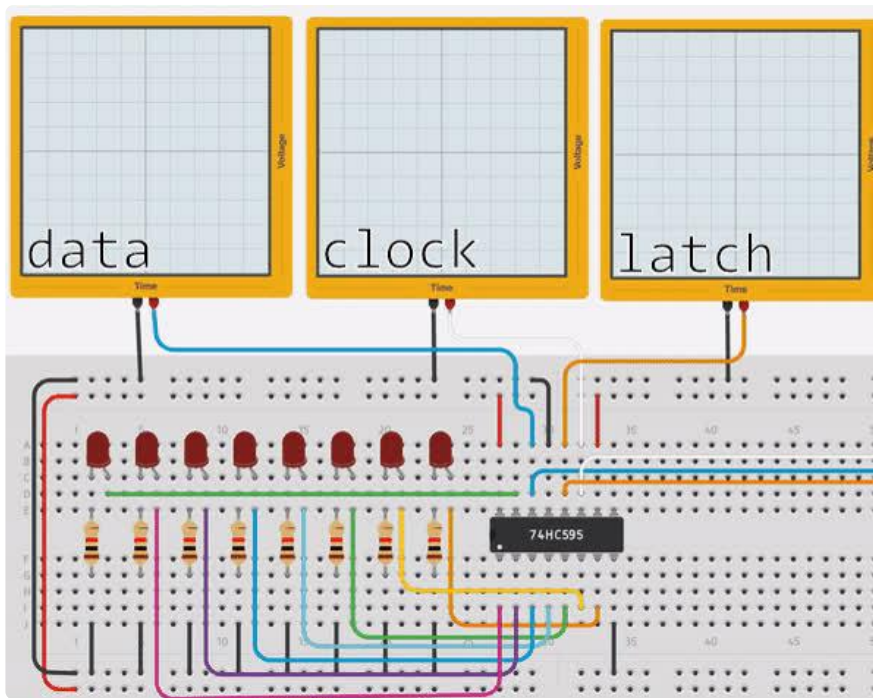

To do this, you set the data pin to either HIGH or LOW, pulse the clock, then set the data pin again and pulse the clock repeating until you have shifted out 8 bits of data. Then you pulse the latch and the 8 bits are transferred to the shift registers pins. It sounds complicated but is really simple once you get the hang of it. ([click here for a more in depth look at how a shift register works](#)) ()

Parts



5mm Red LED
Qty: x8

If you'd like to order more red LEDs (they make great indicator lights!) from the Adafruit shop, [click here!](#) ()



74HC595 Shift Register

If you'd like to order more shift registers from the Adafruit shop, [click here!](#) ()



560 Ohm Resistor

Qty: x8

Colors: Green > Blue > Brown

If you'd like to order more resistors from the Adafruit shop [click here!](#) (they are 470ohm but they'll be fine) ()



Breadboard Wiring Bundle

If you'd like to order more wires from the Adafruit shop [click here!](#) ()

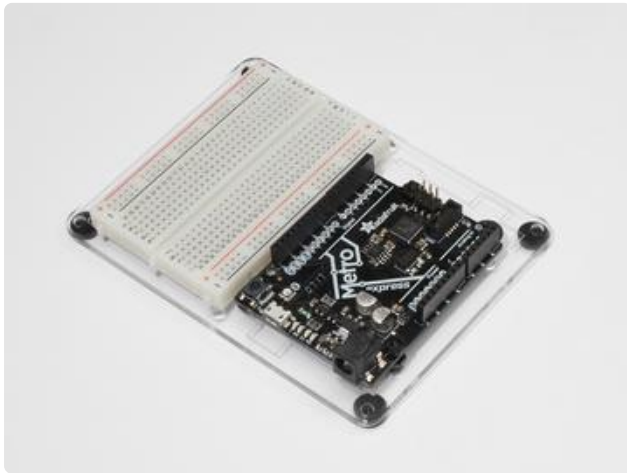

Adafruit Metro (or Metro Express) + Breadboard + Mounting Plate
If you have not assembled this, we have a handy guide! ()

If you'd like to order an extra plastic mounting plate (), Adafruit Metro (), Adafruit Metro Express (), or Mini-Breadboard () from the Adafruit Shop click here!

Wiring

CIRC05 is considerably more complex to wire than other circuits. However, it isn't impossible and just takes some time and patience.

We broke down this into three larger steps, follow all of them in order and you'll be rewarded with a fun LED show!

Chip Orientation

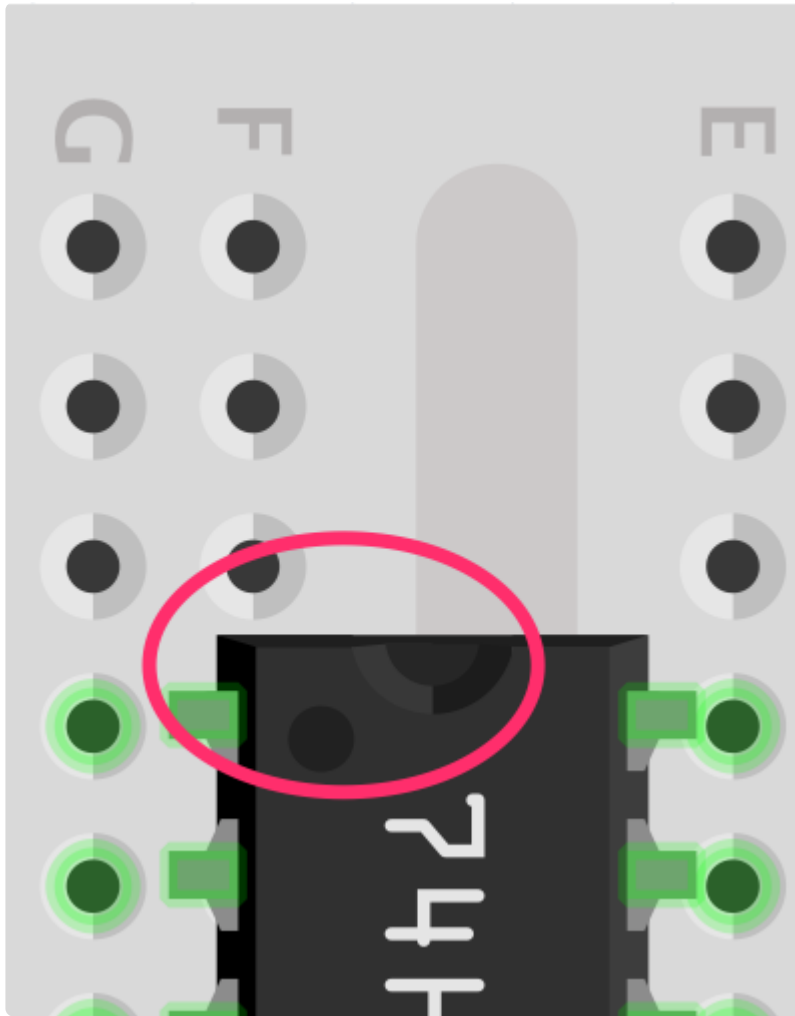

The shift register should be placed such that the half moon circle on it should face the top of the breadboard.

Step 1: Connect Power/GND

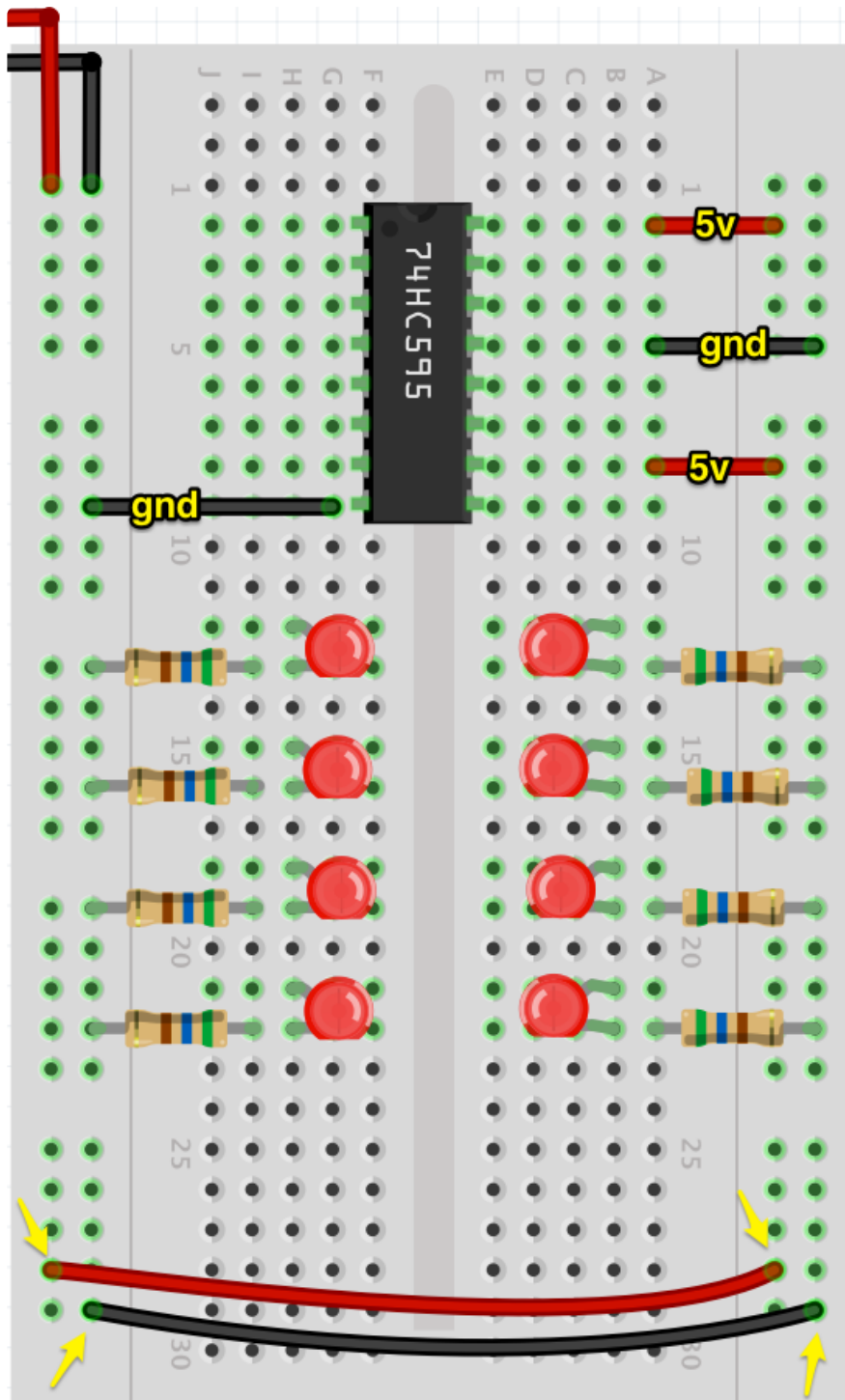

It's easier to see the diagram without the bulk of the wires in the way. Let's first start by connecting all power and ground points on the circuit. Note that we are expanding the power and ground rails by connecting the left rails to the right rails. This is for ease of access and to keep everything tidy.

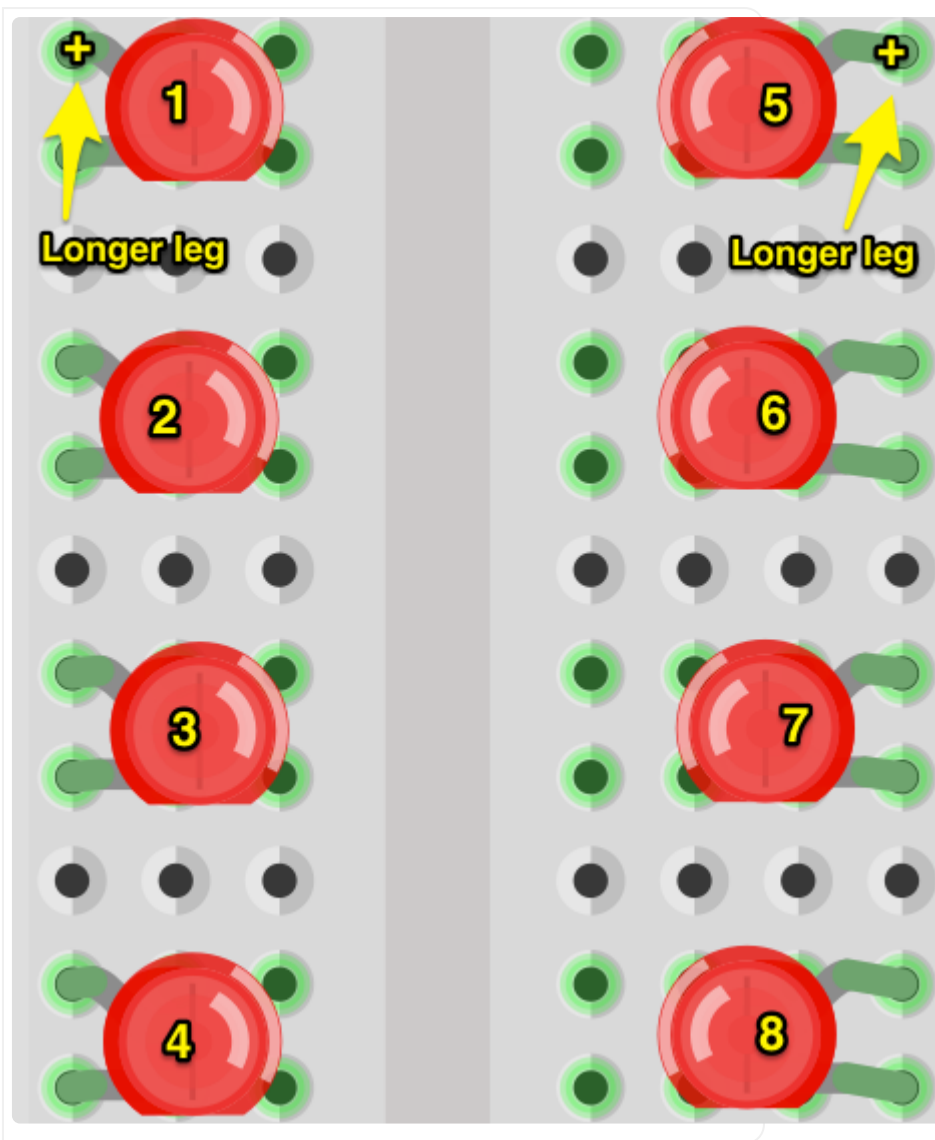
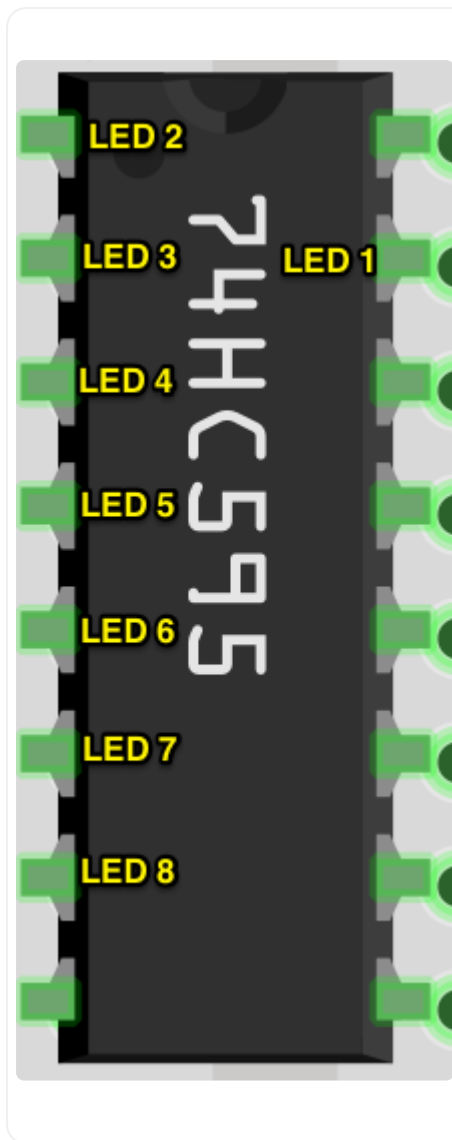

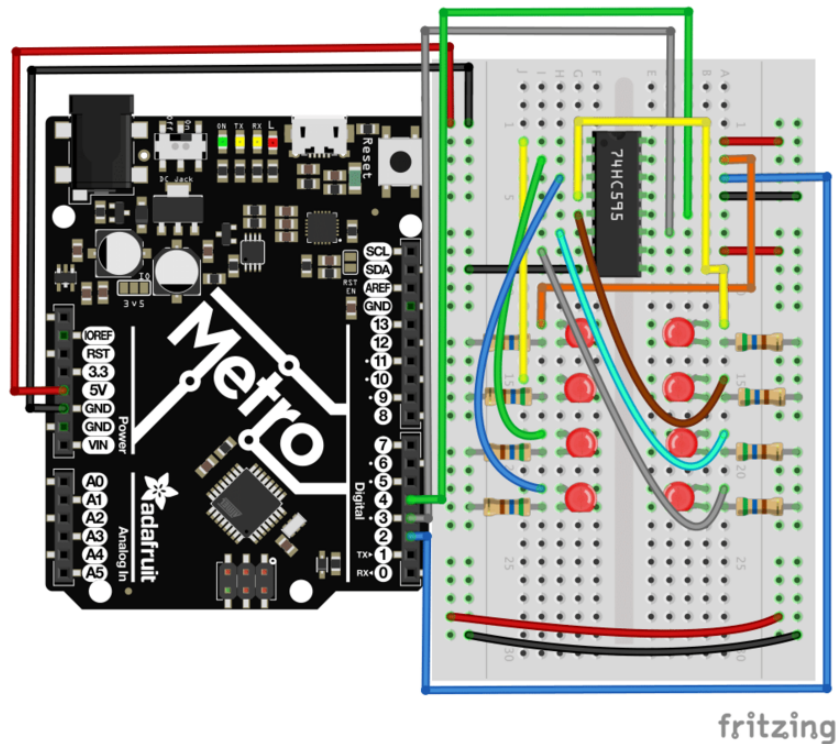

Once you complete the LED wiring, double check all your wiring against the final diagram. After that, move onto the Code section.

Breadboard Layout Sheet

Click here to download the printable Breadboard Layout Sheet for CIRC05

Code

Copy/Paste the code below into an empty arduino sketch. Then [compile and upload it to your metro \(\)](#).

```

/*
 * | Arduino Experimentation Kit Example Code |
 * | CIRC-05 .. 8 More LEDs .. (74HC595 Shift Register) |
 * |-----|
 *
 * We have already controlled 8 LEDs however this does it in a slightly
 * different manner. Rather than using 8 pins we will use just three
 * and an additional chip.
 *
 */

```

```

//Pin Definitions
//Pin Definitions
//The 74HC595 uses a serial communication
//link which has three pins
int data = 2;
int clock = 3;
int latch = 4;

//Used for single LED manipulation
int ledState = 0;
const int ON = HIGH;
const int OFF = LOW;

/*
 * setup() - this function runs once when you turn your Arduino on
 * We set the three control pins to outputs
 */
void setup()
{
  pinMode(data, OUTPUT);
  pinMode(clock, OUTPUT);
  pinMode(latch, OUTPUT);
}

/*
 * loop() - this function will start after setup finishes and then repeat
 * we set which LEDs we want on then call a routine which sends the states to the
 74HC595
 */
void loop() // run over and over again
{
  int delayTime = 100; //the number of milliseconds to delay between LED updates
  for(int i = 0; i < 256; i++){
    updateLEDs(i);
    delay(delayTime);
  }
}

/*
 * updateLEDs() - sends the LED states set in ledStates to the 74HC595
 * sequence
 */
void updateLEDs(int value){
  digitalWrite(latch, LOW); //Pulls the chips latch low
  shiftOut(data, clock, MSBFIRST, value); //Shifts out the 8 bits to the shift
register
  digitalWrite(latch, HIGH); //Pulls the latch high displaying the data
}

/*
 * updateLEDsLong() - sends the LED states set in ledStates to the 74HC595
 * sequence. Same as updateLEDs except the shifting out is done in software
 * so you can see what is happening.
 */
void updateLEDsLong(int value){
  digitalWrite(latch, LOW); //Pulls the chips latch low
  for(int i = 0; i < 8; i++){ //Will repeat 8 times (once for each bit)
    int bit = value & B10000000; //We use a "bitmask" to select only the eighth
//bit in our number (the one we are addressing this
time through
    value = value << 1; //we move our number up one bit value so next time
bit 7 will be
//bit 8 and we will do our math on it
    if(bit == 128){digitalWrite(data, HIGH);} //if bit 8 is set then set our data pin
high
    else{digitalWrite(data, LOW);} //if bit 8 is unset then set the data

```

```

pin low
  digitalWrite(clock, HIGH);           //the next three lines pulse the clock
pin
  delay(1);
  digitalWrite(clock, LOW);
  }
  digitalWrite(latch, HIGH); //pulls the latch high shifting our data into being
displayed
}

//These are used in the bitwise math that we use to change individual LEDs
//For more details http://en.wikipedia.org/wiki/Bitwise\_operation
int bits[] = {B00000001, B00000010, B00000100, B00001000, B00010000, B00100000,
B01000000, B10000000};
int masks[] = {B11111110, B11111101, B11111011, B11110111, B11101111, B11011111,
B10111111, B01111111};
/*
 * changeLED(int led, int state) - changes an individual LED
 * LEDs are 0 to 7 and state is either 0 - OFF or 1 - ON
 */
void changeLED(int led, int state){
  ledState = ledState & masks[led]; //clears ledState of the bit we are addressing
  if(state == ON){ledState = ledState | bits[led];} //if the bit is on we will add
it to ledState
  updateLEDs(ledState);           //send the new LED state to the shift register
}

```

Not Working?

The Metro's Power LED goes out

The chip is inserted backwards. Turn off the power to your Metro, then rotate the chip such that the half-moon cutout on the chip faces the top of the breadboard.

Still not working?

Sorry to sound like a broken record, but make absolutely sure your wiring is correct. If you're unsure: pull everything out and start fresh.

Frustrated?

This circuit is both simple and complex at the same time, let us know your frustration with it so we can address it in future editions of the kit.

Make It Better

Doing it the Hard Way

The Metro makes complex actions very simple. A perfect example of this is shifting and manipulating data. However, one of the nice things about the Metro is that you can adjust the difficulty of what you are trying to achieve.

In the `loop()`, switch `updateLEDs(i);` to `updateLEDsLong(i);`

Did you notice anything different when you ran it this time?

You shouldn't have! There was no difference in the actions the code took. The code was changed to communicate with the LEDs one bit at a time by using the serial peripheral interface.

Controlling Individual LEDs

Just like CIRC02, you can individually control the LEDs on your breadboard. The current state of the eight LEDs are stored in one 8-bit value ([for more info on this subject, we have a great Collin's Lab video on Binary and Hex \(\)](#)). The code provided already takes care of the [bit manipulations \(\)](#).

To control individual LEDs, we replace the code within `loop()` with the following:

```
int delayTime = 100; // # of ms to delay btween LED updates
for(int i=0; i<8; i++){
  changeLED(i, ON);
  delay(delayTime);
}
for(int i=0;i<8;i++){
  changeLED(i,OFF);
  delay(delayTime);
}
```

Then, compile and upload this to your Metro. The code will cause the LEDs to light up one after another and then turn off. Read through the code and the links for a better understanding of how it works.

More Animations

If you did CIRC02, there was a part in the Make It Better section about [adding additional animations \(\)](#). The format of changing the LEDs in this circuit will be similar.

CIRC02 let you change the LEDs using

```
digitalWrite(LED, state)
```

CIRC05 uses the `changeLED()` routine to perform the same operation:

```
changeLED(LED, state)
```

You can repurpose the code from CIRC02's additional animations by first copying the animation code from CIRC02 into this sketch and then changing all the `digitalWrite()` routines to `changeLED()`. You'll also need to change a few other things, just follow the compiler errors and it works itself out.

CIRC06: Music with Piezo

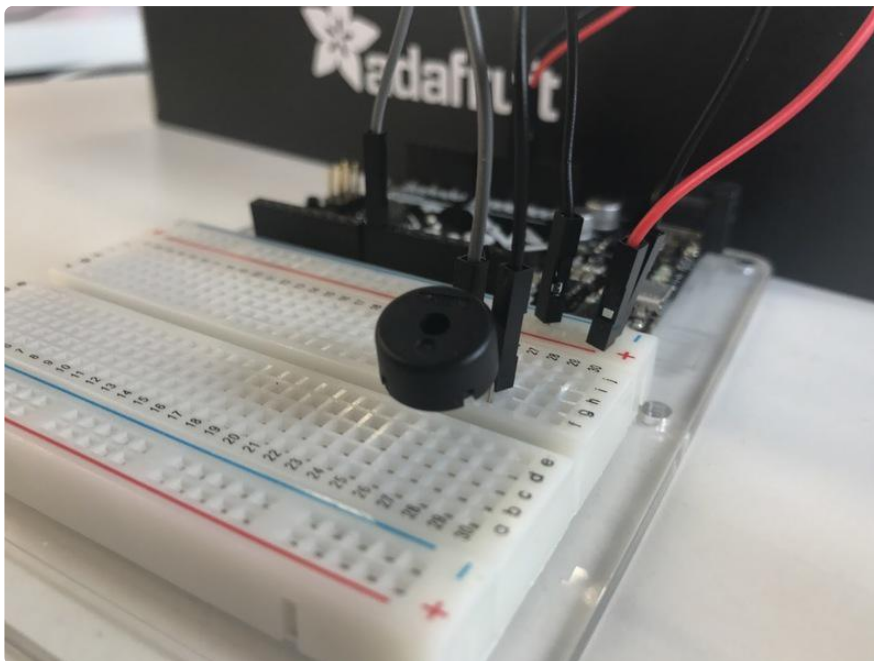

To this point we have controlled light, motion, and electrons. Let's tackle sound next. But sound is an analog phenomena, how will our digital Metro cope? We will once again rely on its incredible speed which will let it mimic analog behavior.

We are going to attach a piezo element to one of the Metro's digital pins. A piezo element makes a clicking sound each time it is pulsed with current. If we pulse it at the right frequency (for example 440 times a second to make the note middle A), these clicks will run together to produce notes.

Let's get to experimenting and make your Metro play "Twinkle Twinkle Little Star"!

Parts



Piezo Buzzer

If you'd like to order another Piezo Buzzer from the Adafruit shop, [click here!](#) ()

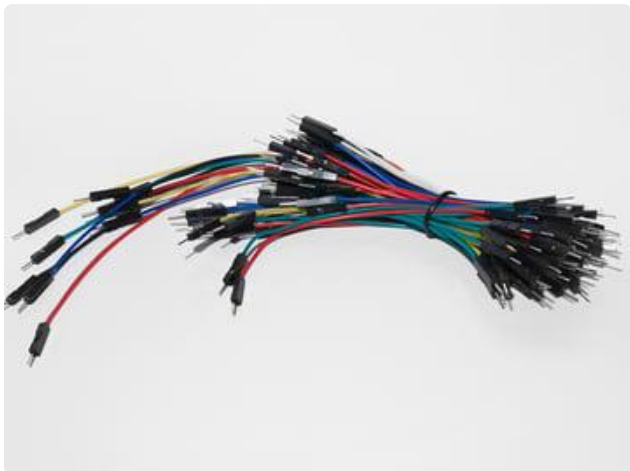

Breadboard Wiring Bundle

If you'd like to order more wires from the Adafruit shop [click here!](#) ()

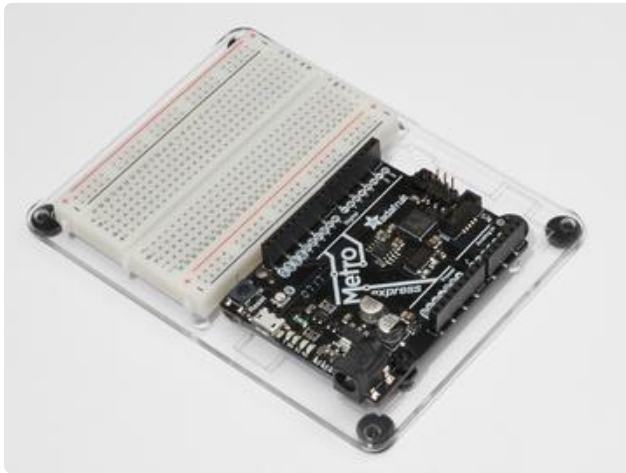

Adafruit Metro (or Metro Express) + Breadboard + Mounting Plate
If you have not assembled this, we have a [handy guide!](#) ()

If you'd like to order an extra plastic mounting plate (), Adafruit Metro (), Adafruit Metro Express (), or Mini-Breadboard () from the Adafruit Shop click [here!](#)

Wiring

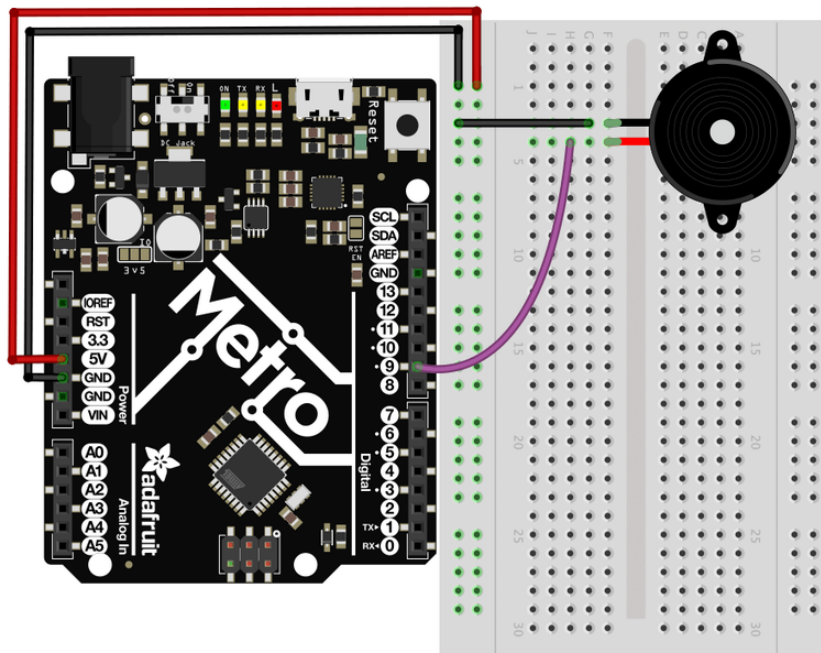

Wiring this circuit is much easier than CIRC05:

1. Connect your GND and 5V rails.
2. Connect one side of the piezo to GND
3. Connect the other side of the piezo to the Metro's Digital Pin 9

Breadboard Layout Sheet

Click here to download the printable
Breadboard Layout Sheet for
CIRC06

Code

Copy/Paste the code below into an empty arduino sketch. Then [compile and upload it to your Metro \(\)](#).

```
// CIRC06 - Music with Piezo

int speakerPin = 9;
int length = 15; // the number of notes
char notes[] = "ccggaagffeeddc "; // a space represents a rest
int beats[] = { 1, 1, 1, 1, 1, 1, 2, 1, 1, 1, 1, 1, 1, 2, 4 };
int tempo = 300;

void playNote(char note, int duration) {
  char names[] = { 'c', 'd', 'e', 'f', 'g', 'a', 'b', 'C' };
  int tones[] = { 1915, 1700, 1519, 1432, 1275, 1136, 1014, 956 };
  // play the tone corresponding to the note name
  for (int i = 0; i < 8; i++) {
    if (names[i] == note) {
      tone(speakerPin, tones[i], duration);
    }
  }
}

void setup() {
  pinMode(speakerPin, OUTPUT);
}

void loop() {
  for (int i = 0; i < length; i++) {
    if (notes[i] == ' ') {
      delay(beats[i] * tempo); // rest
    } else {
      playNote(notes[i], beats[i] * tempo);
    }

    // pause between notes
    delay(tempo / 2);
  }
}
```

Not Working?

No sound is coming out of the speaker

Given the size and shape of the piezo element it is easy to miss the right holes on the breadboard. Try double checking its placement.

Can't Think While the Melody is Playing? Annoyed by the sound?

Just pull up the piezo element whilst you think, upload your program then plug it back in.

Tired of Twinkle Twinkle Little Star?

The code is written so you can easily add your own songs, check out the Make It Better section for more info on modifying the code.

Make It Better

Playing with Speed

The timing for each note is calculated based on variables, as such we can tweak the sound of each note or the timing. To change the speed of the melody, we only need to change one line:

```
int tempo = 300; --> int tempo = (new #);
```

Change **new #** to a larger number to slow the melody down, or a smaller number to speed it up!

Tuning the Notes

If you are worried about the notes being a little bit out of tune, this can be fixed as well. The notes have been calculated based on a formula from the comment block at the top of the program. But to tune individual notes just adjust their values in the `tones[]` array up or down until they sound right. Each note is matched by its name in the `names[]` array.

For example: If we want a c (c=1915) to be a higher pitch, we need to find it's initial value:

```
char names[] = { 'c', 'd', 'e', 'f', 'g', 'a', 'b', 'C' };
```

```
int tones[] = { 1915, 1700, 1519, 1432, 1275, 1136, 1014, 956 };
```

and then change the number within tones[] to something larger, let's go with 1975:

```
char names[] = { 'c', 'd', 'e', 'f', 'g', 'a', 'b', 'C' };
```

```
int tones[] = { 1975, 1700, 1519, 1432, 1275, 1136, 1014, 956 };
```

Composing your own Melodies:

While the program is pre-set to play 'Twinkle Twinkle Little Star', the program can easily be changed to play something else.

A song takes the format of one integer (`int length`) and two arrays (`char notes[]` and `int beats[]`).

`int length` - defines the number of notes

`char notes[]` - defines each note

`int beat[]` - defines how long each note will be played for

Twinkle Twinkle Little Star

```
int length = 15;  
char notes[] = {"ccggaagffeeddc"};  
int beats[] = { 1, 1, 1, 1, 1, 1, 2, 1, 1, 1, 1, 1, 1, 2, 4 };
```

Happy Birthday (First line)

```
int length = 13;  
char notes[] = {"ccdcfeccdcgf"};  
int beats[] = {1,1,1,1,1,2,1,1,1,1,1,2,4};
```

To become familiar with how code works, it's always a good idea to look at examples. Above are two songs. Run them, and then modify them to compose your own melody.

CIRC07: Button Pressing

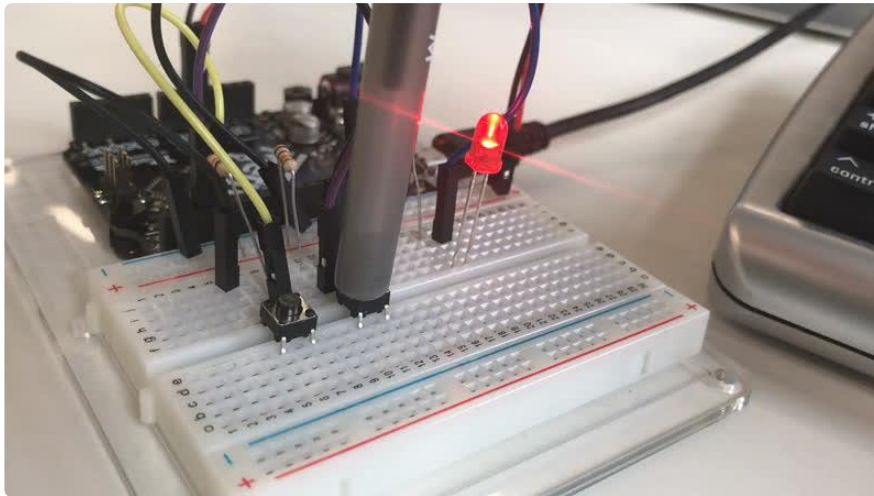

Up to this point we have focused entirely on outputs. It's time to get our Metro to listen, watch and feel. We'll start with a simple pushbutton.

Wiring up the pushbutton is simple. There is one component, the pull up resistor, that might seem out of place. This is included because a Metro doesn't sense the same way we do (i.e: button pressed, button unpressed). Instead it looks at the voltage on the pin and decides whether it is HIGH or LOW. The button is set up to pull the Metro's pin LOW when it is pressed, however, when the button is unpressed the voltage of the pin will float (causing occasional errors). To get the Metro to reliably read the pin as HIGH when the button is unpressed, we add a pull up resistor into the circuit.

Parts



Pushbutton
Qty: x2

[If you'd like to order more pushbuttons from the Adafruit shop, click here! \(\)](#)



5mm Red LED

If you'd like to order more red LEDs (they make great indicator lights!) from the Adafruit shop, [click here!](#) ()



10K Ohm Resistor

Colors: Brown > Black > Orange

Qty: x2

If you'd like to order more 10k ohm pull-up resistors from the Adafruit shop, [click here!](#) ()



560 Ohm Resistor

Colors: Green > Blue > Brown

If you'd like to order more resistors from the Adafruit shop [click here!](#) (they are 470ohm but they'll be fine) ()



Breadboard Wiring Bundle

If you'd like to order more wires from the Adafruit shop click [here!](#) ()

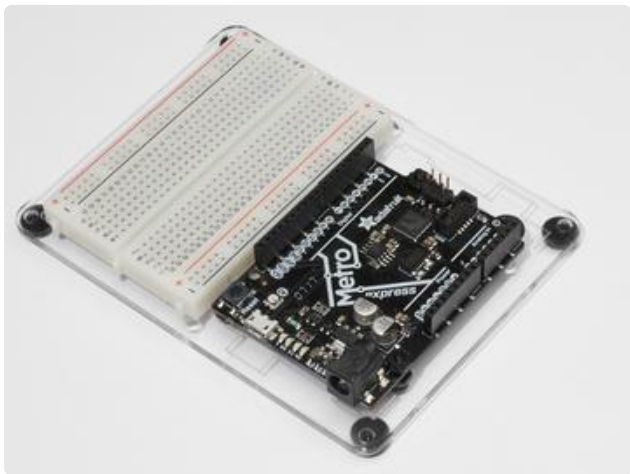

Adafruit Metro (or Metro Express) + Breadboard + Mounting Plate

If you have not assembled this, we have a [handy guide!](#) ()

If you'd like to order an extra plastic mounting plate (), Adafruit Metro (), Adafruit Metro Express (), or [Mini-Breadboard](#) () from the Adafruit Shop click [here!](#)

Wiring

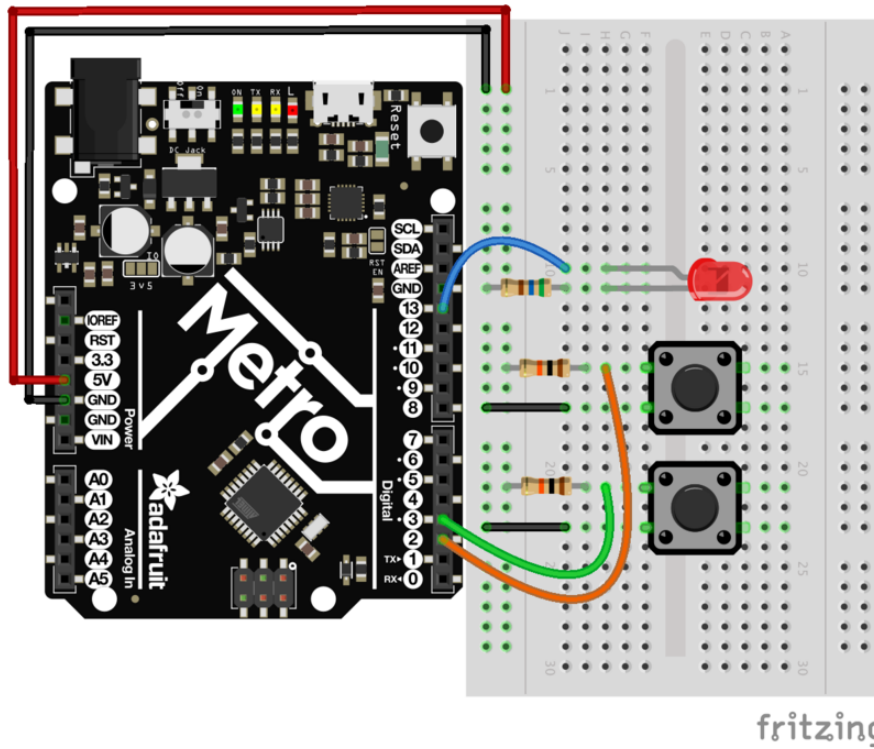

The wiring for CIRC07 is simple - the wires going to the digital pins on the Metro sit between the switch terminal and the resistor.

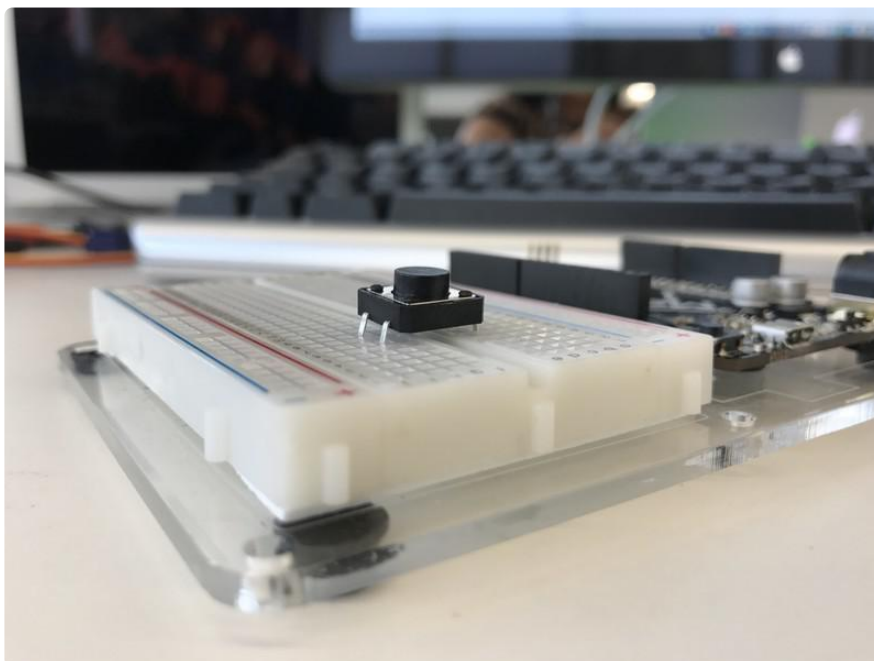

Pro-Tip: When pushing the pushbutton into the breadboard, be careful not to bend the legs outwards too much or else it won't make contact with the breadboard. Seat it in the gap in the breadboard.

Breadboard Layout Sheet

Click here to download the printable
Breadboard Layout Sheet for
CIRC07

Code

This code is provided for you in the Arduino editor under: File > Examples > 2. Digital > Button. Load it into the Arduino editor, then [compile and upload it to your Metro \(\)](#).

Code:

```
/*
  Button

  Turns on and off a light emitting diode(LED) connected to digital pin 13,
  when pressing a pushbutton attached to pin 2.

  The circuit:
  - LED attached from pin 13 to ground
  - pushbutton attached to pin 2 from +5V
  - 10K resistor attached to pin 2 from ground

  - Note: on most Arduinos there is already an LED on the board
    attached to pin 13.

  created 2005
  by DojoDave <http://www.0j0.org>
  modified 30 Aug 2011
  by Tom Igoe

  This example code is in the public domain.

  http://www.arduino.cc/en/Tutorial/Button
*/

// constants won't change. They're used here to set pin numbers:
const int buttonPin = 2;    // the number of the pushbutton pin
const int ledPin = 13;     // the number of the LED pin

// variables will change:
int buttonState = 0;        // variable for reading the pushbutton status

void setup() {
  // initialize the LED pin as an output:
  pinMode(ledPin, OUTPUT);
  // initialize the pushbutton pin as an input:
  pinMode(buttonPin, INPUT);
}

void loop() {
  // read the state of the pushbutton value:
  buttonState = digitalRead(buttonPin);

  // check if the pushbutton is pressed. If it is, the buttonState is HIGH:
```

```
if (buttonState == HIGH) {  
  // turn LED on:  
  digitalWrite(ledPin, HIGH);  
} else {  
  // turn LED off:  
  digitalWrite(ledPin, LOW);  
}  
}
```

Not Working?

Light Not Turning On

The pushbutton is square and because of this it is easy to put it in the wrong way. Give it a 90 degree twist and see if it starts working.

The light is not fading

A bit of a silly mistake we constantly made, when you switch from simple on off to fading remember to move the LED wire from pin 13 to pin 9.

Feeling Underwhelmed?

No worries these circuits are all super stripped down to make playing with the components easy, but once you throw them together the sky is the limit.

Make It Better

Light Switch

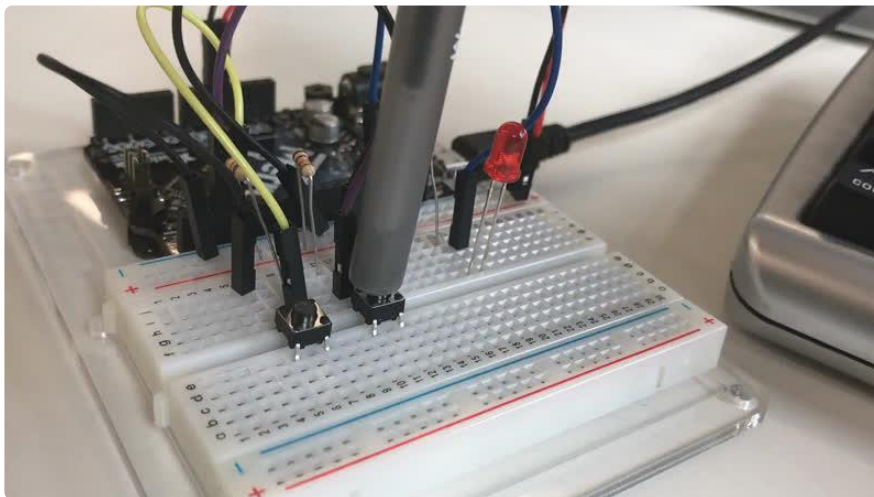

If you feel the initial example is a bit underwhelming ("I don't need a metro to do this!") , let's use the metro to do something a bit more complicated. We are going to make a light-switch. One of the buttons on your breadboard is going to turn on the light, and the other is going to turn it off!

This is super simple, we're just going to change a few lines of code:

```
int ledPin = 13; // choose the pin for the LED
int buttonPin1 = 3; // button 1
int buttonPin2 = 2; // button 2

void setup() {
  pinMode(ledPin, OUTPUT); // declare LED as output
  pinMode(buttonPin1, INPUT); // make button 1 an input
  pinMode(buttonPin2, INPUT); // make button 2 an input
}

void loop() {
  if (digitalRead(buttonPin1) == LOW) {
    digitalWrite(ledPin, LOW); // turn LED OFF
  }
  else if (digitalRead(buttonPin2) == LOW) {
    digitalWrite(ledPin, HIGH); // turn LED ON
  }
}
```

Copy and paste the code into a blank sketch, upload it to the board, and start toggling the LED on and off.

Fading

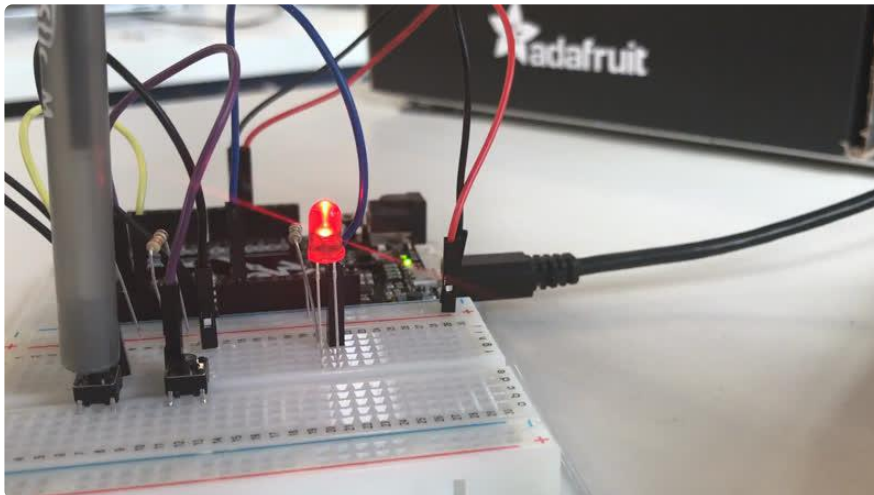

Let's use the buttons to control an analog signal. To do this, you will need to change the wire connecting the LED from Pin 13 to Pin 9.

In the code, change:

```
int ledPin = 13; -> int ledPin = 9;
```

Next, change the `loop()` code to read:

```
int value = 0;
void loop() {
  if(digitalRead(buttonPin1) == LOW){
    value--;
  }
  else if(digitalRead(buttonPin2) == LOW){
    value++;
  }
  value = constrain(value, 0, 255);
  analogWrite(ledPin, value);
  delay(10);
}
```

Changing Fade Speed

If you would like the LED to fade faster or slower, there is only one line of code that needs to be changed:

```
delay(10); -> delay(new #);
```

To fade faster: make the number smaller.

To fade slower: make the number larger.

CIRC08: Twisting

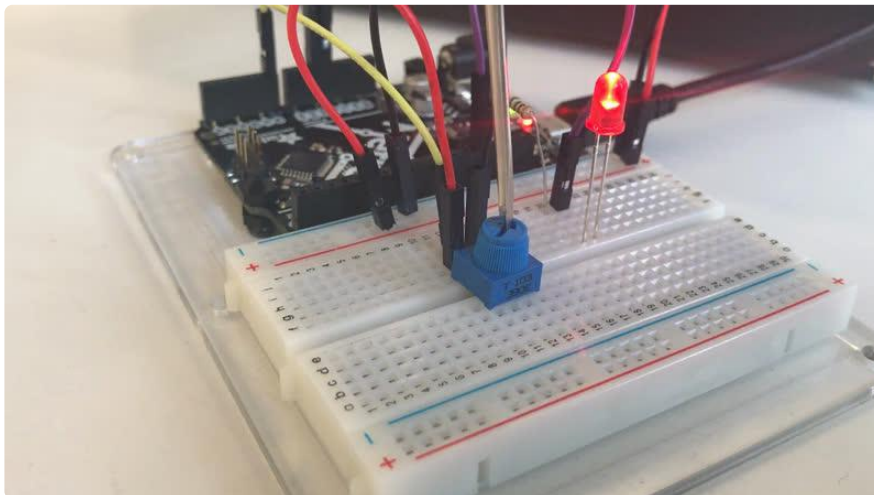

Along with the digital pins, the Metro also has 6 pins which can be used for analog input.

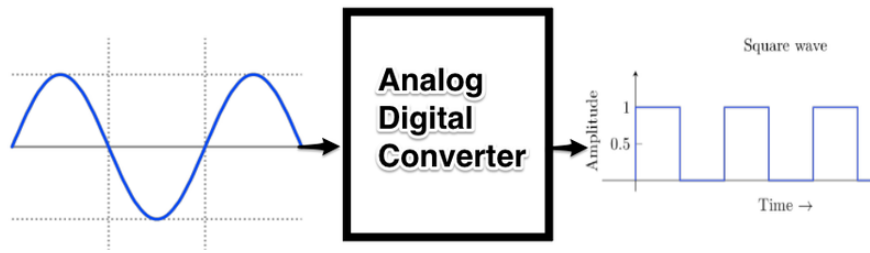

These inputs take a voltage (from 0 to 5 volts) and convert it to a digital number between 0 (0 volts) and 1023 (5 volts) (10 bits of resolution).

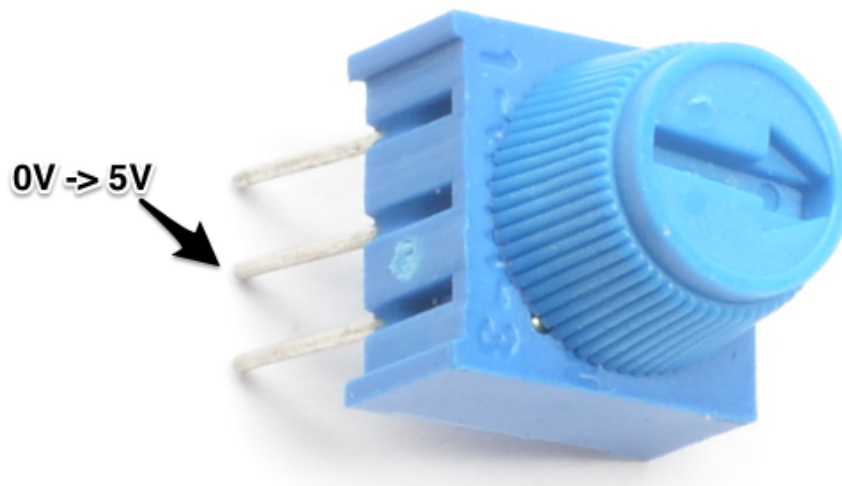

A very useful device that exploits these inputs is a potentiometer (also called a variable resistor). When it is connected with 5 volts across its outer pins the middle pin will read some value between 0 and 5 volts dependent on the angle to which it is turned (ie. 2.5 volts in the middle). We can then use the returned values as a variable in our program.

Parts

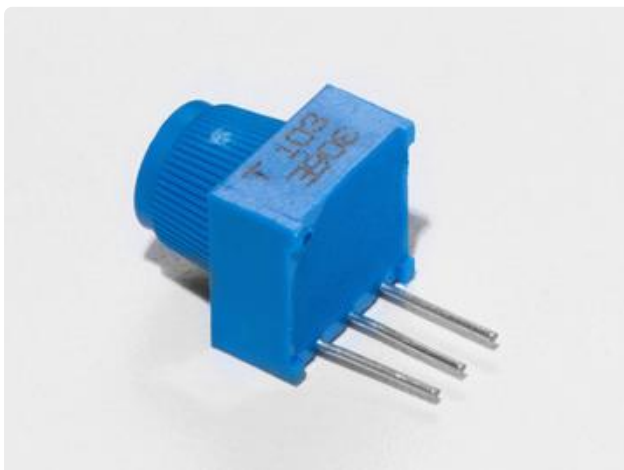

Breadboard Trim Potentiometer - 10k

If you'd like to buy an extra trimpot from the [Adafruit store](#), click here! ()



5mm Red LED

If you'd like to order more red LEDs (they make great indicator lights!) from the Adafruit shop, [click here!](#) ()



560 Ohm Resistor

Colors: Green > Blue > Brown

If you'd like to order more resistors from the Adafruit shop [click here!](#) (they are 470ohm but they'll be fine) ()



Breadboard Wiring Bundle

If you'd like to order more wires from the Adafruit shop [click here!](#) ()

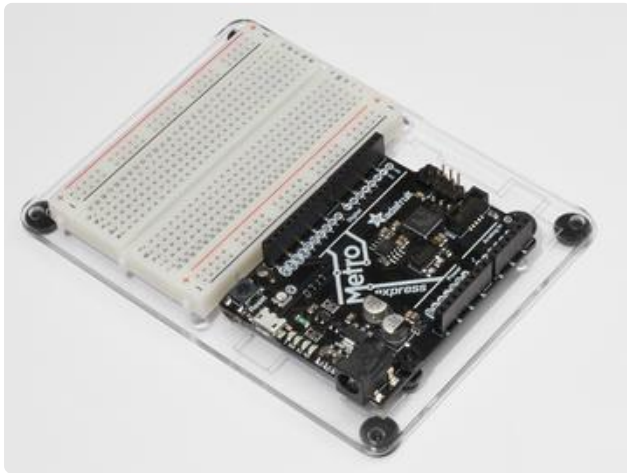

Adafruit Metro (or Metro Express) + Breadboard + Mounting Plate
If you have not assembled this, we have a [handy guide!](#) ()

If you'd like to order an extra plastic mounting plate (), Adafruit Metro (), Adafruit Metro Express (), or Mini-Breadboard () from the Adafruit Shop click [here!](#)

Wiring

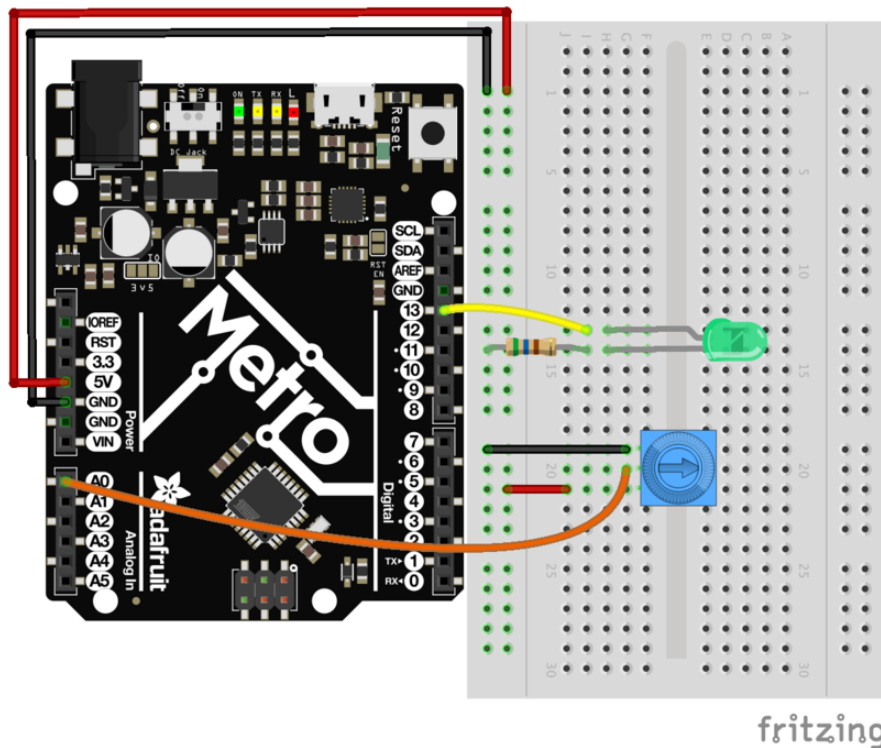

CIRC08 is quick to wire up:

1. Longer end of the LED connects to a 560 ohm resistor, which connects to ground.
2. The shorter (cathode) end connects to the metro's digital Pin 13
3. The middle pin of the potentiometer connects to Analog Pin 0
4. Outer pins of the potentiometer connect to the 5V and GND rails.

Printable Breadboard Sheet

Click here to download the printable Breadboard Layout Sheet for CIRC08

Wiring for Metro Express

If you are using the [Adafruit Metro Express \(\)](#), the wiring below should be used. [If you're not sure what board you have, check this page. \(\)](#)

The power rail on your breadboard should connect to the 3.3V pin on the Metro Express

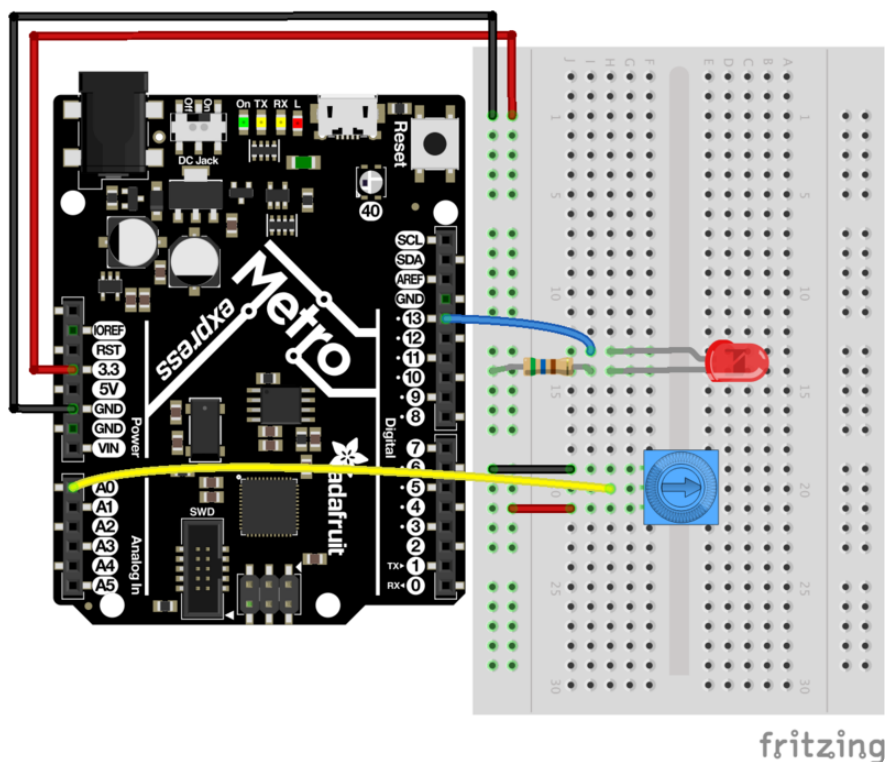

Code

Arduino includes this example, find it under: File > Examples > 3.Analog > Analog Input

Then [compile and upload it to your metro \(\)](#). Tweak the potentiometer to change the LEDs brightness.

If you are having trouble finding or loading the example, the code is below:

```
/*
  Analog Input
  Demonstrates analog input by reading an analog sensor on analog pin 0 and
  turning on and off a light emitting diode(LED) connected to digital pin 13.
  The amount of time the LED will be on and off depends on
  the value obtained by analogRead().

  The circuit:
  * Potentiometer attached to analog input 0
  * center pin of the potentiometer to the analog pin
  * one side pin (either one) to ground
  * the other side pin to +5V
  * LED anode (long leg) attached to digital output 13
  * LED cathode (short leg) attached to ground

  * Note: because most Arduinos have a built-in LED attached
  to pin 13 on the board, the LED is optional.

  Created by David Cuartielles
  modified 30 Aug 2011
  By Tom Igoe

  This example code is in the public domain.

  http://www.arduino.cc/en/Tutorial/AnalogInput
*/

int sensorPin = A0;    // select the input pin for the potentiometer
int ledPin = 13;      // select the pin for the LED
int sensorValue = 0;  // variable to store the value coming from the sensor

void setup() {
  // declare the ledPin as an OUTPUT:
  pinMode(ledPin, OUTPUT);
}

void loop() {
  // read the value from the sensor:
  sensorValue = analogRead(sensorPin);
  // turn the ledPin on
  digitalWrite(ledPin, HIGH);
  // stop the program for <sensorValue> milliseconds:
  delay(sensorValue);
  // turn the ledPin off:
  digitalWrite(ledPin, LOW);
  // stop the program for for <sensorValue> milliseconds:
  delay(sensorValue);
}
```

Not Working?

Sporadically Working

This is most likely due to a slightly dodgy connection with the potentiometer's pins. This can usually be fixed by taping the potentiometer down.

Not Working?

Make sure you haven't accidentally connected the potentiometer's wiper to digital pin 0 rather than analog pin 0. (the row of pins beneath the power pins)

Still Backwards?

You can try operating the circuit upside down. Sometimes this helps.

Using the Arduino Serial Plotter

We're going to start plotting...values! Arduino comes with a cool tool called the Serial Plotter. It can give you visualizations of variables in real-time. This is super useful for visualizing data, troubleshooting your code, and visualizing your variables as waveforms.

We are going to first need to modify the code for CIRC08. Copy and paste the code below into the Arduino Editor. Then compile and upload.

```
/*
  Analog Input, but with Serial Plotter!
  Demonstrates analog input by reading an analog sensor on analog pin 0 and
  turning on and off a light emitting diode(LED) connected to digital pin 13.
  The amount of time the LED will be on and off depends on
  the value obtained by analogRead().

  The circuit:
  * Potentiometer attached to analog input 0
  * center pin of the potentiometer to the analog pin
  * one side pin (either one) to ground
  * the other side pin to +5V
  * LED anode (long leg) attached to digital output 13
  * LED cathode (short leg) attached to ground

  * Note: because most Arduinos have a built-in LED attached
  to pin 13 on the board, the LED is optional.

  Created by David Cuartielles
  modified 30 Aug 2011
  By Tom Igoe

  This example code is in the public domain.

  http://www.arduino.cc/en/Tutorial/AnalogInput
*/

int sensorPin = A0;    // select the input pin for the potentiometer
int ledPin = 13;      // select the pin for the LED
int sensorValue = 0;  // variable to store the value coming from the sensor

void setup() {
  // declare the ledPin as an OUTPUT:
  pinMode(ledPin, OUTPUT);
  // begin the serial monitor @ 9600 baud
```

```
Serial.begin(9600);
}

void loop() {
  // read the value from the sensor:
  sensorValue = analogRead(sensorPin);

  Serial.println(sensorValue);
  Serial.print(" ");

  delay(20);
}
```

When you call `Serial.println(value)`, the Serial Plotter will put that variable on the plot. The Y-Axis of the plot auto-resizes.

If you want to plot multiple variables, you'll need a `Serial.println(value)` call for each of the variables, separated by a `Serial.print(" ")` or `Serial.print("\t")`:

```
Serial.print(variable1);
```

```
Serial.print(" ");
```

```
Serial.println(variable2);
```

Let's try it out with the new code above. Compile and upload the program above, then navigate to Tools > Serial Plotter. The code uses a baud rate of 9600, make sure it's set in the serial monitor as 9600 too.

You should see something like this when you twist the trim potentiometer around:

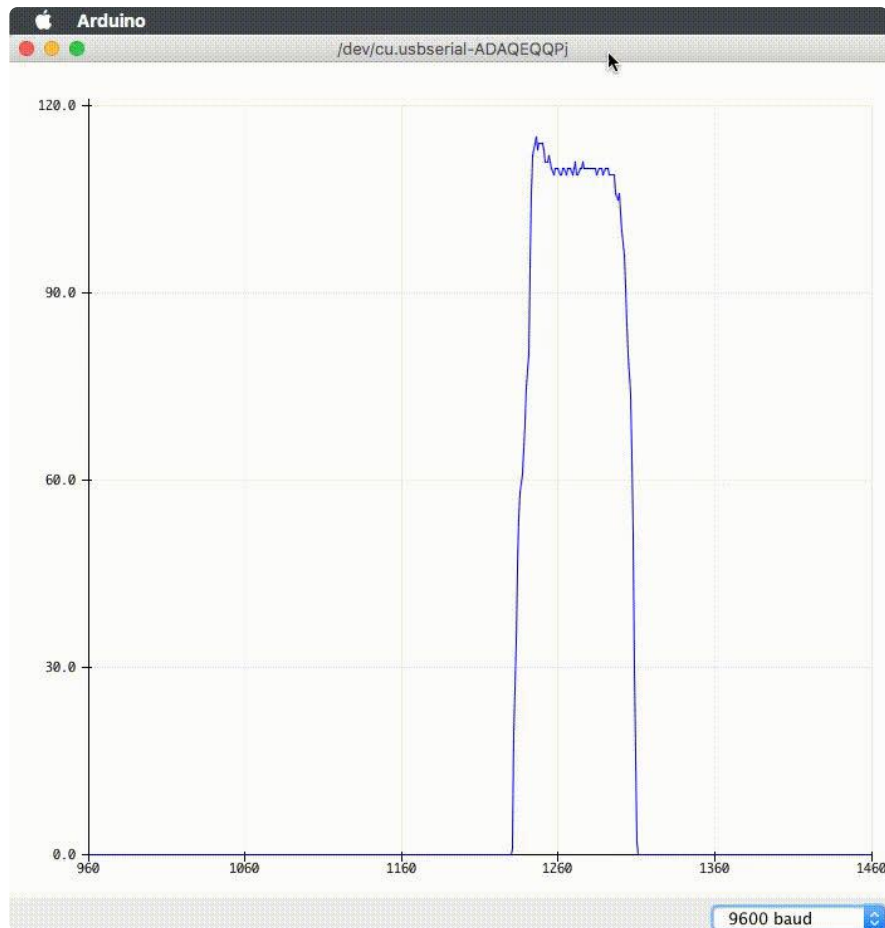

Make It Better

Threshold Switching

Sometimes you will want to switch an output when a value exceeds a certain threshold.

To do this with a potentiometer, change the `loop()` code to:

```
void loop() {
  int threshold = 512;
  if(analogRead(sensorPin) > threshold) {
    digitalWrite(ledPin, HIGH);
  }
  else {
    digitalWrite(ledPin, LOW);
  }
}
```

This will cause the LED to turn on when the value is above 512 (halfway on the potentiometer dial), you can adjust the sensitivity by changing the threshold value.

Fading

Let's control the brightness of an LED directly from the potentiometer. To do this we need to first change the pin the LED is connected to.

Move the wire from Pin 13 to Pin 9 and change the following line in the code:

```
int ledPin = 13; -> int ledPin = 9;
```

Then, change the loop code to:

```
void loop() {  
  int value = analogRead(sensorPin) / 4;  
  analogWrite(ledPin, value);  
}
```

Upload the code and watch as your LED fades in relation to your potentiometer spinning. (Note: the reason we divide the value by 4 is the `analogRead()` function returns a value from 0 to 1023 (10 bits), and `analogWrite()` takes a value from 0 to 255 (8 bits))

Controlling the servo

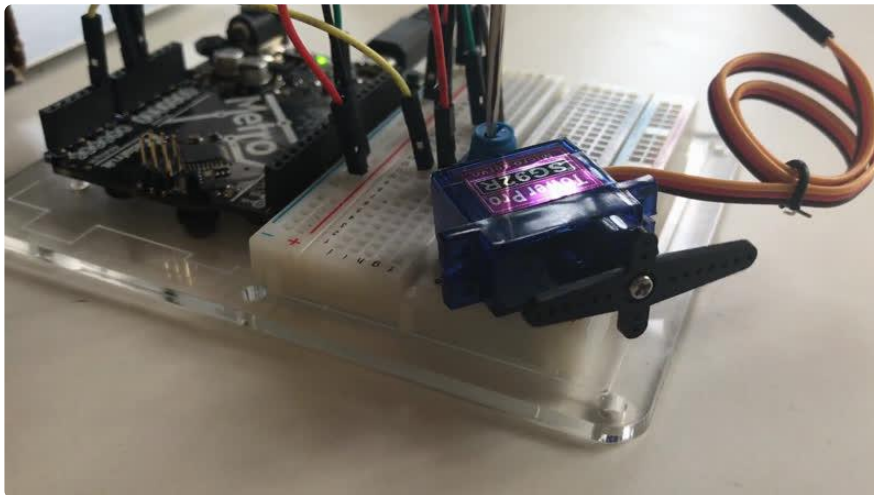

This is a really neat example and brings a couple of circuits changing the threshold value. Wire up the servo like you did in CIRC-04:

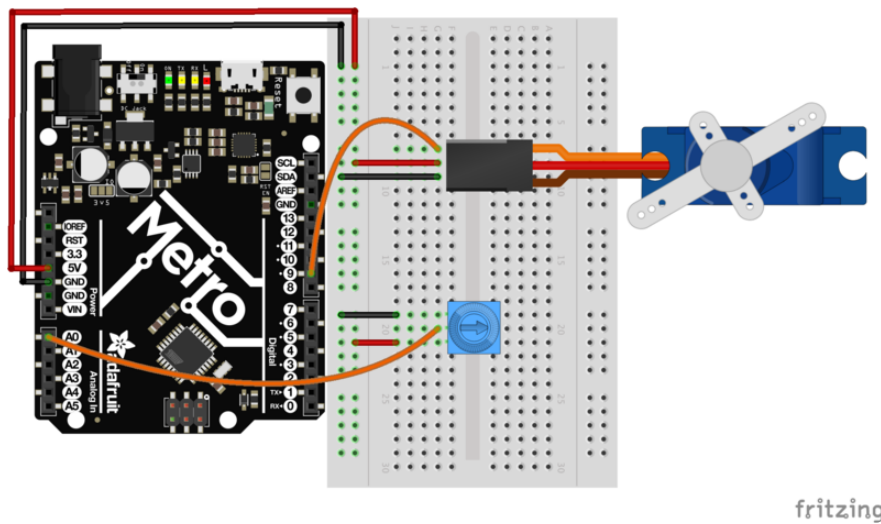

Then, open the example program Knob (File > Examples > Servo > Knob). Upload to your METRO and then watch as the servo shaft turns as you turn the potentiometer.

CIRC09: Light

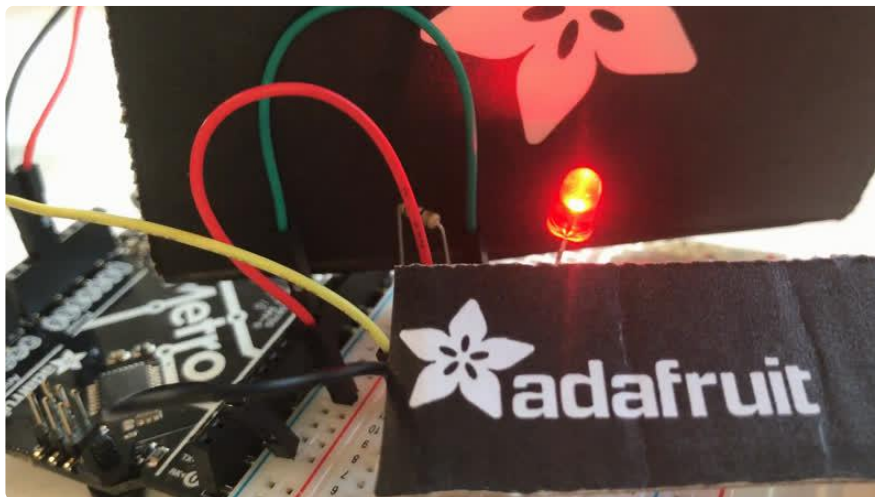

Whilst getting input from a potentiometer can be useful for human controlled experiments, what do we use when we want an environmentally controlled experiment?

We use exactly the same principles but instead of a potentiometer (twist based resistance) we use a photo resistor (light based resistance). The Metro cannot directly sense resistance (it senses voltage) so we set up a [voltage divider](#) (). The exact voltage at the sensing pin is calculable, but for our purposes (just sensing relative light) we can experiment with the values and see what works for us. A low value will occur when the sensor is well lit while a high value will occur when it is in darkness.

Parts



5mm Red LED

If you'd like to order more red LEDs (they make great indicator lights!) from the [Adafruit shop](#), click here! ()



Photo Sensor

If you'd like to order another photoresistor from the [Adafruit shop](#), click here! ()



10K Ohm Resistor

Colors: Brown > Black > Orange

If you'd like to order more 10k ohm pull-up resistors from the [Adafruit shop](#), click here! ()



560 Ohm Resistor

Colors: Green > Blue > Brown

If you'd like to order more resistors from the Adafruit shop click [here!](#) (they are 470ohm but they'll be fine) ()

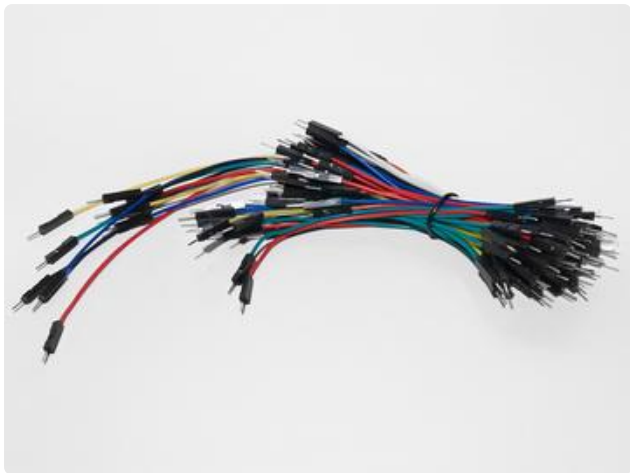

Breadboard Wiring Bundle

If you'd like to order more wires from the Adafruit shop click [here!](#) ()

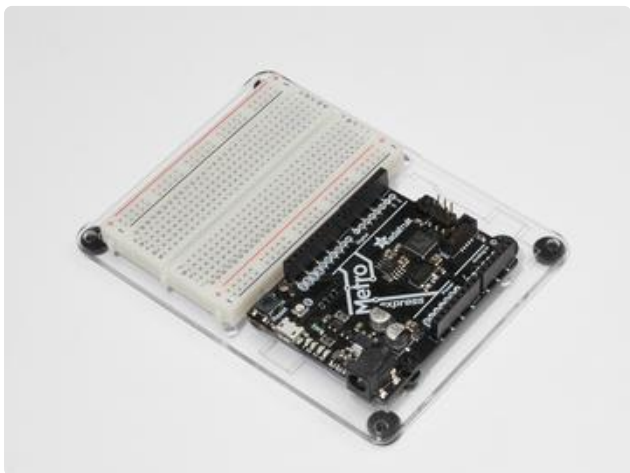

Adafruit Metro (or Metro Express) + Breadboard + Mounting Plate

If you have not assembled this, we have a [handy guide!](#) ()

If you'd like to order an extra plastic mounting plate (), Adafruit Metro (), Adafruit Metro Express (), or Mini-Breadboard () from the Adafruit Shop click [here!](#)

Wiring

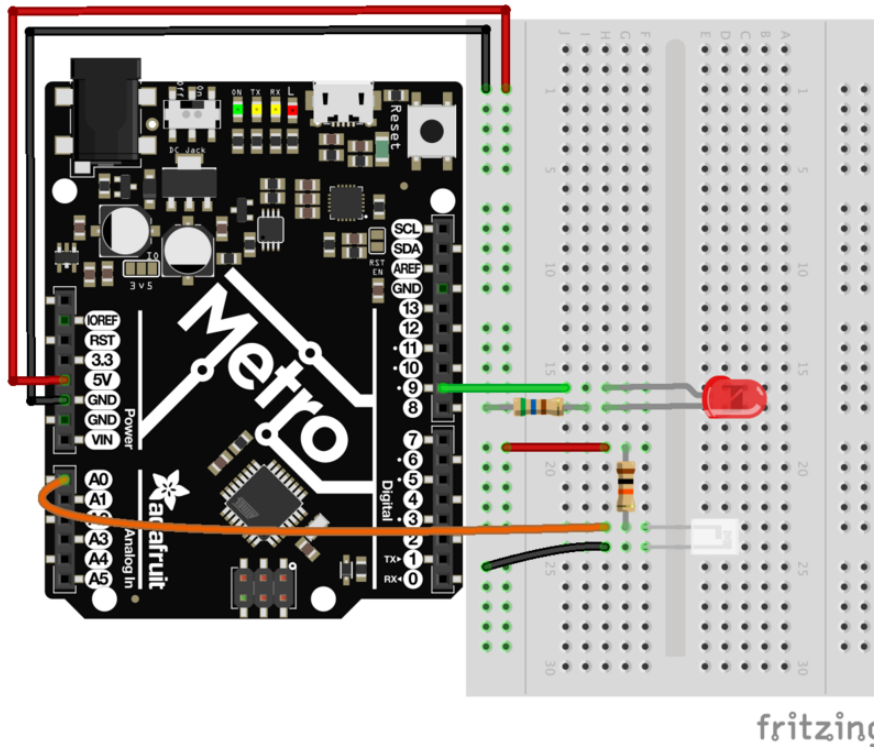

1. Wire up the LED: anode to pin 9. Cathode to a 560 ohm resistor and then to ground.
2. Wire up the Photoresistor. Connect one end of the 10k ohm resistor to the power rail. Connect the other end of it to A0 and one end of the the photoresistor. The other end of the resistor should be grounded.

Printable Breadboard Layout Sheet

Click here to download the printable Breadboard Layout Sheet for CIRC09

Wiring for Metro Express

If you are using the [Adafruit Metro Express \(\)](#), the wiring below should be used. [If you're not sure what board you have, check this page. \(\)](#)

The power rail on your breadboard should connect to the 3.3V pin on the Metro Express

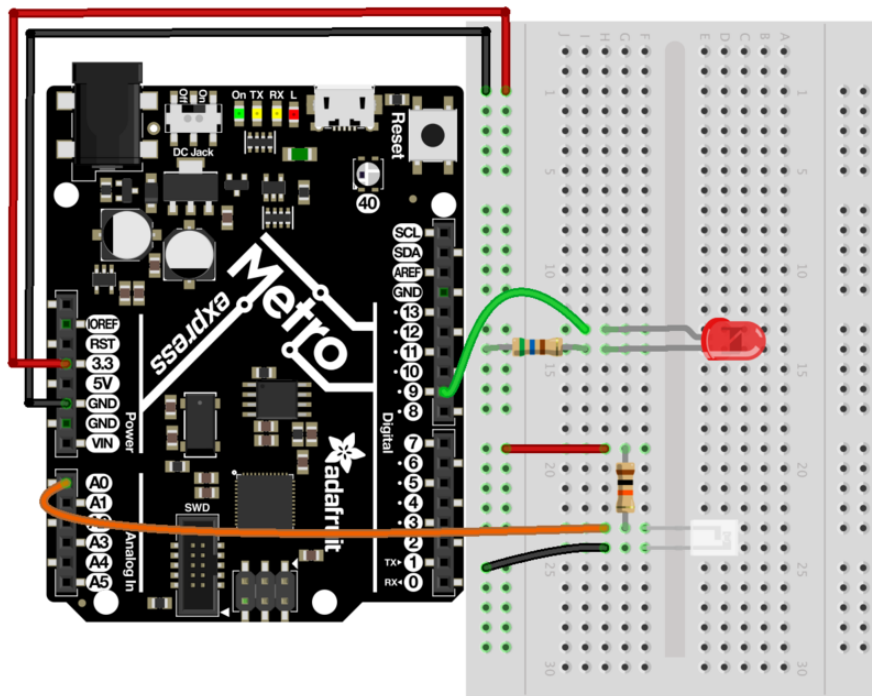

Code

Copy and paste the code below into a new Arduino sketch. Then, [compile and upload it to your metro \(\)](#).

```
// CIRC09 - Light
int lightPin = A0;
int ledPin = 9;

void setup()
{
  pinMode(ledPin, OUTPUT);
}

void loop()
{
  int lightLevel = analogRead(lightPin);
  lightLevel = map(lightLevel, 0, 700, 0, 255);
  analogWrite(ledPin, lightLevel);
}
```

Not Working?

If you're having issues with the Photo Sensor: flip it around, chances are the orientation is backwards.

LED Remains Dark

This is a mistake we continue to make time and time again, if only they could make an LED that worked both ways. Pull it up and give it a twist.

It Isn't Responding to Changes in Light.

Given that the spacing of the wires on the photo-resistor is not standard, it is easy to misplace it. Double check its in the right place.

Still not quite working?

You may be in a room which is either too bright or dark. Try turning the lights on or off to see if this helps. Or if you have a flashlight near by give that a try.

Make It Better

Reverse the Response

Perhaps you would like the opposite response. Don't worry we can easily reverse this response just change:

```
analogWrite(ledPin, lightLevel); -> analogWrite(ledPin, 255 -  
lightLevel);
```

Upload your modified sketch and watch the response change.

Night Light

Rather than controlling the brightness of the LED in response to light, lets instead turn it on or off based on a threshold value. Change the loop() code with:

```
void loop(){  
  int threshold = 300;  
  if(analogRead(lightPin) > threshold){  
    digitalWrite(ledPin, HIGH);  
  }  
  else{  
    digitalWrite(ledPin, LOW);  
  }  
}
```

Light Controlled Servo

This circuit uses the same wiring for both the Metro and the Metro Express. Make sure your power rail is plugged into 3V instead of 5V.

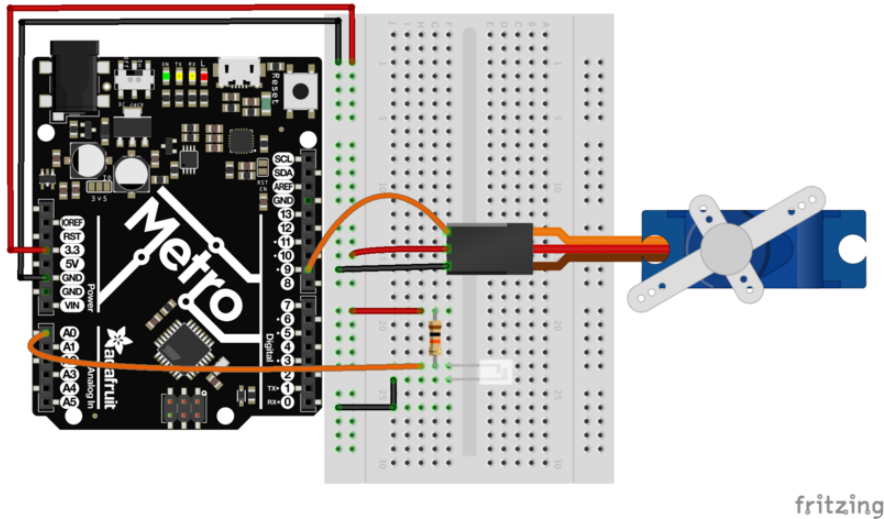

Lets use our newly found light sensing skills to control a servo (and at the same time engage in a little bit of Arduino code hacking). Wire up a servo connected to pin 9 (like in CIRC-04). Then open the Knob example program (the same one we used in CIRC-08) File > Examples > Library-Servo > Knob. Upload the code to your board and watch as it works unmodified.

Using the full range of your servo

You'll notice that the servo will only operate over a limited portion of its range. This is because with the voltage dividing circuit we use the voltage on analog pin 0 will not range from 0 to 5 volts but instead between two lesser values (these values will change based on your setup). To fix this play with the line: `val = map(val, 0, 1023, 0, 179);` ([For hints on what to do, click here](#) ())

Learn More!

[If you'd like to understand the magic behind the photo sensor, we have a learn guide explaining more about this subject](#) ()

CIRC10: Temperature

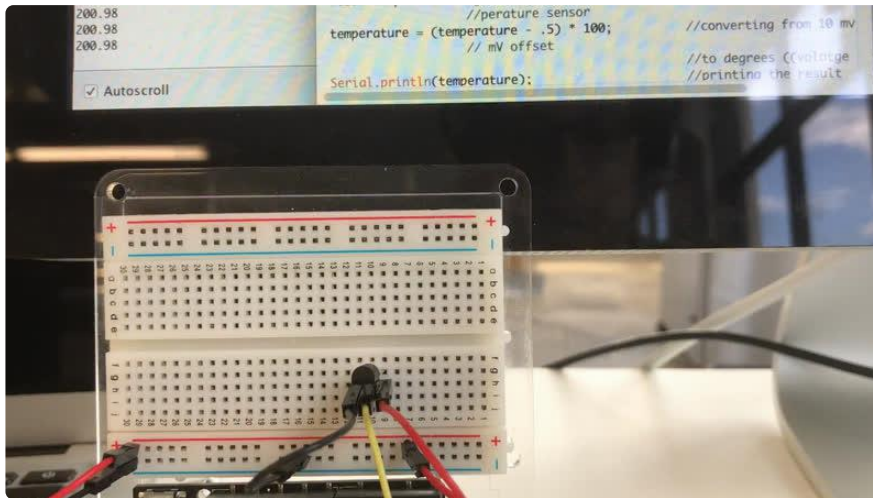

What's the next phenomenon we will measure with our Metro? Temperature.

To do this we'll use a rather complicated IC (integrated circuit) hidden in a package identical to our P2N2222AG transistors, the TMP36. It has three pin's, ground, signal and power..and is easy to use.

It outputs 10 millivolts per degree centigrade on the signal pin (to allow measuring temperatures below freezing there is a 500 mV offset eg. 25 degrees C = 750 mV, 0 degrees C = 500mV). To convert this from the digital value to degrees, we will use some of the Arduino's math abilities. Then to display it we'll use one of the IDE's rather powerful features, the debug window. We'll output the value over a serial connection to display on the screen. Let's get to it.

One extra note, this circuit uses the Arduino IDE's serial monitor. To open this, first upload the program then click the button which looks like a square with an antennae.

Parts

The Analog Temperature Sensor looks a LOT like the NPN Transistor, make sure it says "TMP36" on it!

[Am I using a NPN Transistor or a TMP36 Temperature Sensor? \(\)](#)



Analog Temperature Sensor

If you'd like an extra temperature sensor, you can grab one from the [Adafruit shop](#), [click here](#) ()



Breadboard Wiring Bundle

If you'd like to order more wires from the [Adafruit shop](#) [click here!](#) ()

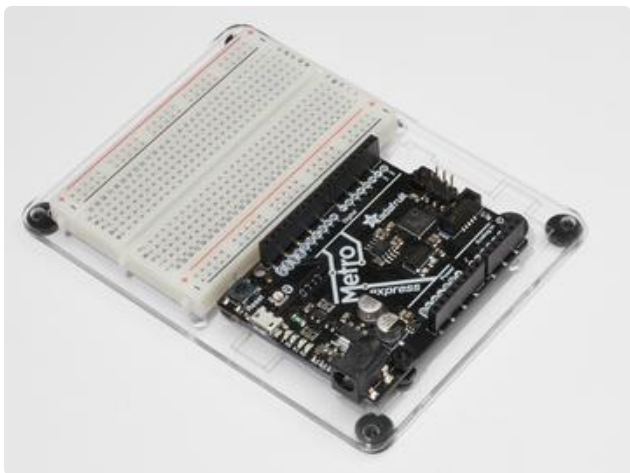

Adafruit Metro (or Metro Express) + Breadboard + Mounting Plate
If you have not assembled this, we have a [handy guide!](#) ()

If you'd like to order an extra plastic mounting plate (), [Adafruit Metro](#) (), [Adafruit Metro Express](#) (), or [Mini-Breadboard](#) () from the [Adafruit Shop](#) [click here!](#)

Wiring

Pay attention to the pinout of the Temperature Sensor. Wiring it incorrectly heat it up quickly. Unplug this the metro from power BEFORE touching the sensor.

Printable Breadboard Sheet

Click here to download the printable Breadboard Layout Sheet for CIRC10

Wiring for Metro Express

If you are using the [Adafruit Metro Express](#) (), the wiring below should be used. [If you're not sure what board you have, check this page.](#) ()

The power rail on your breadboard should connect to the 3.3V pin on the Metro Express

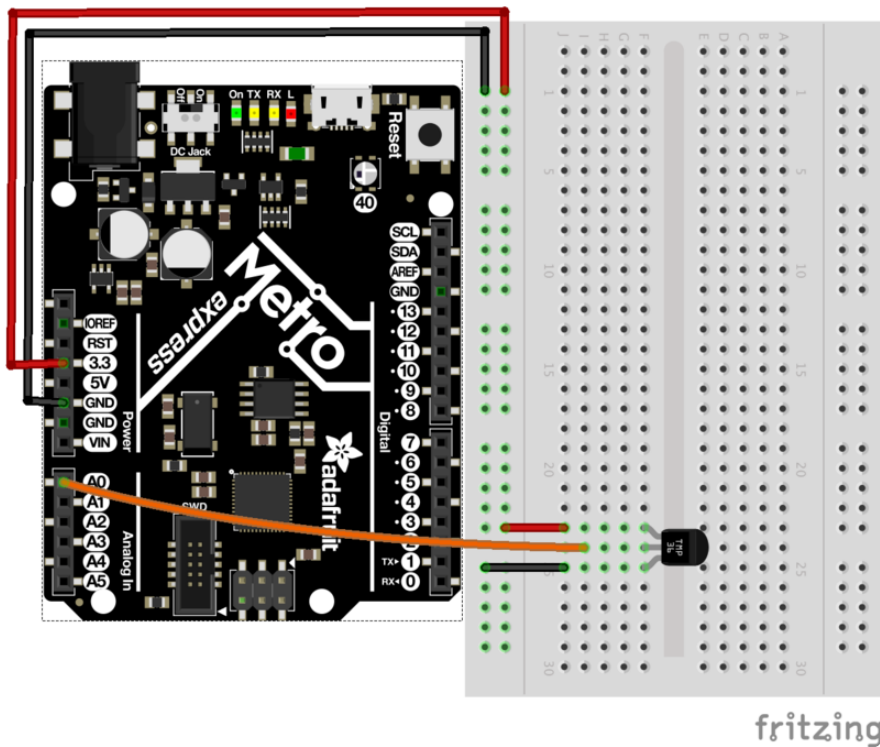

Code

Copy/Paste the code below.

Then [compile and upload it to your metro](#) ().

```
/*  
 * CIRC10: Temperature  
 * for use with both the Metro and Metro Express  
 */
```

```

* by Brent Rubell for Adafruit Industries.   Support Open Source, buy Adafruit!
*/

#define ANALOGREFVOLTAGE 5.555

//TMP36 Pin
int temperaturePin = A0;

void setup() {
  // Start the Serial connection
  Serial.begin(9600);
}

void loop() {
  float temperature = 0;

  temperature = getVoltage(temperaturePin);
  Serial.println(temperature);

  // Convert to degrees C
  temperature = (temperature - .5) * 100;
  Serial.println(temperature);

  delay(1000);
}

float getVoltage(int pin) {
  return(float(analogRead(pin))* float(ANALOGREFVOLTAGE/1023.000));
}

```

Using the Arduino Serial Monitor



```

Arduino  File  Edit  Sketch  Tools  Help
circ10 | Arduino 1.8.3
circ10
/*
 | Arduino Experimentation Kit Example Code
 | CIRC-10  .: Temperature :..(TMP36 Temperature Sensor) |
 *
 *
 * A simple program to output the current temperature to the IDE's debug
 *
 * For more details on this circuit: http://tinyurl.com/c89tvd
 */

//TMP36 Pin Variables
int temperaturePin = 0; //the analog pin the TMP36's Vout (sense) pin is
                        //the resolution is 10 mV / degree centigrade
                        //(500 mV offset) to make negative temperatures a

/*
 * setup() - this function runs once when you turn your Arduino on
 * We initialize the serial connection with the computer
 */
void setup()
{
  Serial.begin(9600); //Start the serial connection with the copmuter
                    //to view the result open the serial monitor
                    //last button beneath the file bar (looks like a b
}

```

Click on the magnifying glass icon on the toolbar of the Arduino IDE. You should see the serial monitor pop up and start printing out numbers.

Not Working?

Nothing Seems to Happen

This program has no outward indication it is working. To see the results you must open the Arduino IDE's serial monitor.

Gibberish is Displayed

This happens because the serial monitor is receiving data at a different speed than expected. To fix this, click the pull-down box that reads "*** baud" and change it to "9600 baud".

Temperature Value is Unchanging

Try pinching the sensor with your fingers to heat it up or pressing a bag of ice against it to cool it down.

Make It Better

Outputting Voltage

This is a simple matter of changing one line. Our sensor outputs 10mv per degree centigrade so to get voltage we simply display the result of `getVoltage()`. Delete the line:

```
temperature = (temperature - .5) * 100;
```

Outputting degrees Fahrenheit

Again this is a simple change requiring only math. to go degrees C -> degrees F we use the formula:

$$(F = C * 1.8) + 32)$$

Add the line:

```
temperature = (((temperature - .5) * 100)*1.8) + 32; before Serial.p  
rintln(temperature);
```

More informative output

Lets add a message to the serial output to make what is appearing in the Serial Monitor more informative.

To do this, change this line:

```
Serial.println(temperature);
```

to:

```
Serial.print(temperature);
```

Then, we add another line with informative text about the temperature on a new line:

```
Serial.println(" degrees centigrade");
```

The change to the first line means when we next output it will appear on the same line.

Changing the serial speed

If you ever wish to output a lot of data over the serial line time is of the essence. We are currently transmitting at 9600 baud but much faster speeds are possible.

To change this change the line:

```
Serial.begin(9600);
```

to:

```
Serial.begin(115200);
```

Upload the sketch turn on the serial monitor, then change the speed from 9600 baud to 115200 baud in the pull down menu. You are now transmitting data 12 times faster.

CIRC10.5: Temperature Alarm

CIRC10 only works when you are connected to the serial monitor. Let's free your board from wires and make a free-standing circuit!

This is a bonus circuit!! We are going to make a free-standing alarm to alert us if it's too hot/cold.

Running the Metro Express off a 9V Battery

One of the included parts in the Experimenter's Kit is the [9V battery clip \(\)](#).

If you have a 9V battery, snap it into the clip and plug the clip into the barel-jack of the Metro:

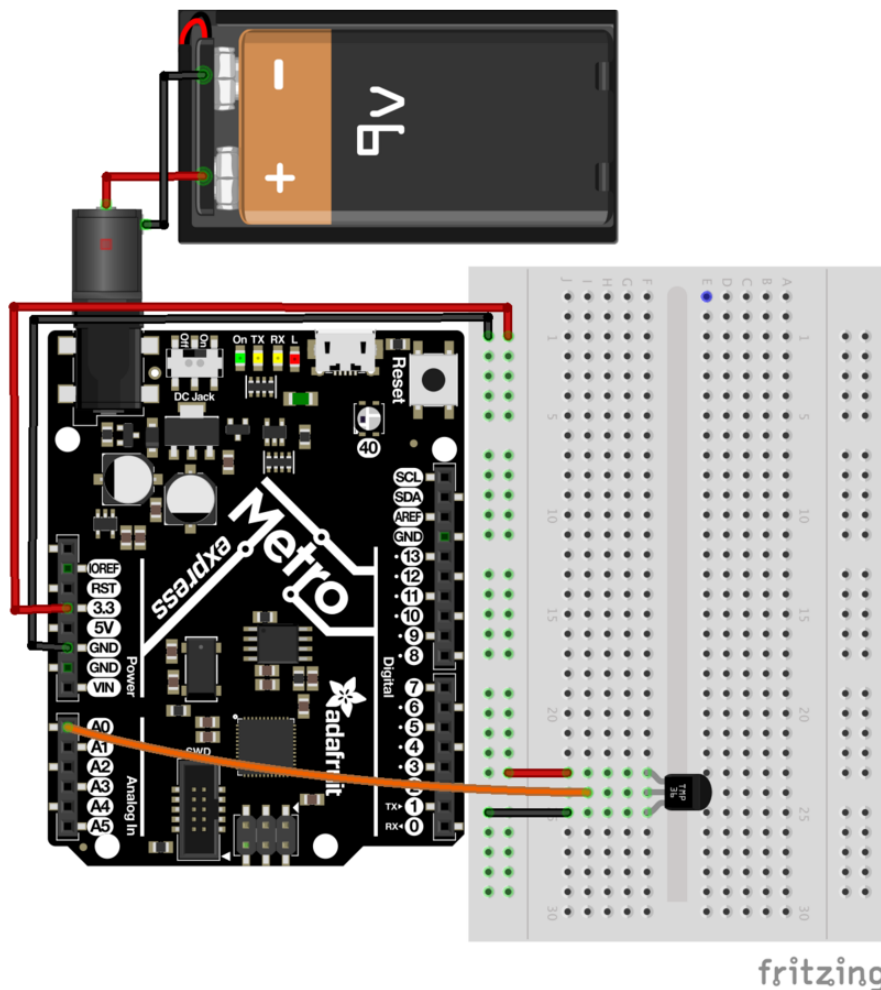

Our temperature sensor is now running off of a 9V battery. This is awesome, but we still have no way to be alerted of temperatures getting too hot/cold.

Add a Piezo!

The Piezo element was first introduced in CIRC06. You send it digital output and it buzzes. Next up is buzzing the piezo when it exceeds a certain temperature. The Piezo can be used as an alarm with minimal modifications to the circuit:

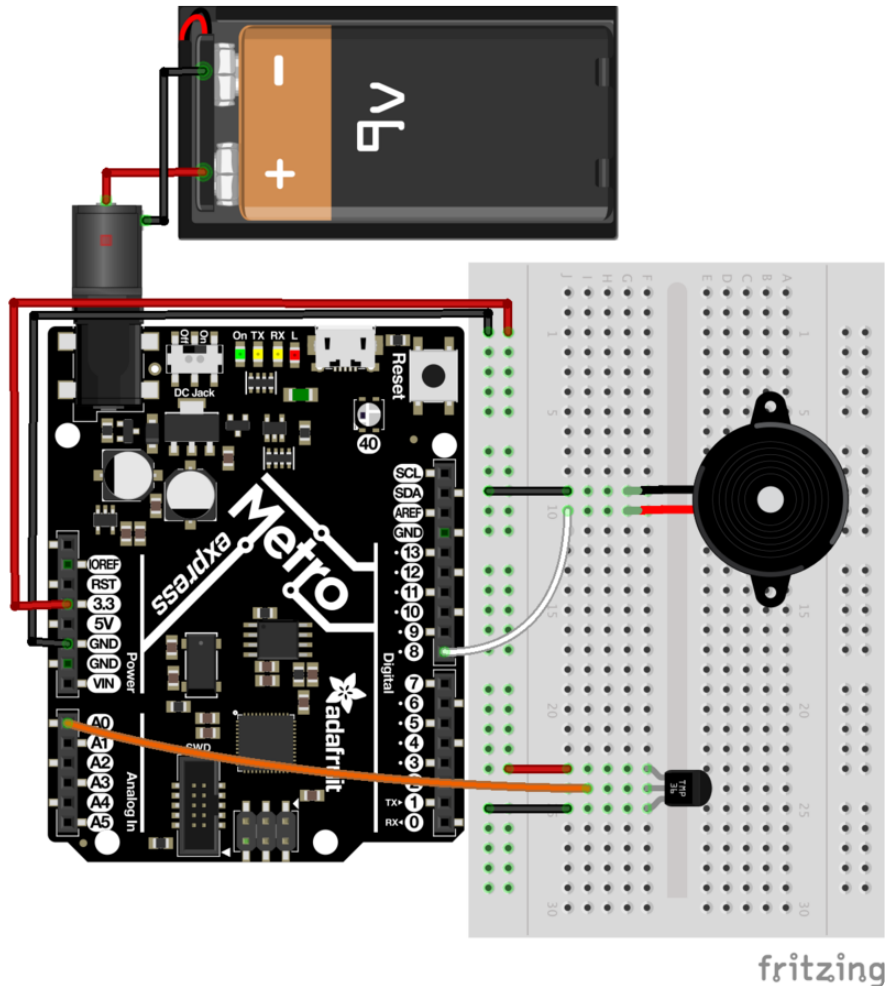

Code for the temperature alarm is below (copy and paste it into a blank Arduino sketch), compile and upload it to your Metro:

```
/* CIRC10.5: Temperature Alarm
 * (a bonus circuit for MetroX)
 *
 * by Brent Rubell for Adafruit Industries
 */

#define ANALOGREFVOLTAGE 5.555

// TMP36 Pin
int temperaturePin = A0;

// Piezo Pin
int piezoPin = 8;
// Freezing
float freezeTemp = 0;
// Boiling
```



```

float boilTemp = 26;

void setup()
{
  // Start the Serial connection
  Serial.begin(9600);
}

void loop()
{
  float temperature = 0;

  temperature = getVoltage(temperaturePin);

  // Convert to degrees C
  temperature = (temperature - .5) * 100;
  Serial.println(temperature);

  if(temperature < freezeTemp) {
    tone(piezoPin, 1100, 1000);
  }
  else if(temperature > boilTemp) {
    tone(piezoPin, 1100, 1000);
  }

  delay(1000);
}

float getVoltage(int pin) {
  return(float(analogRead(pin))* float(ANALOGREFVOLTAGE/1023.000));
}

```

Changing the variables

We predefined freezing and boiling variables in Celsius, but if you want to use Fahrenheit (or [kelvin](#) ()) just change the variables below to other values:

```
float freezeTemp = 0;
```

```
float boilTemp = 26;
```

CIRC11: Larger Loads with Relays

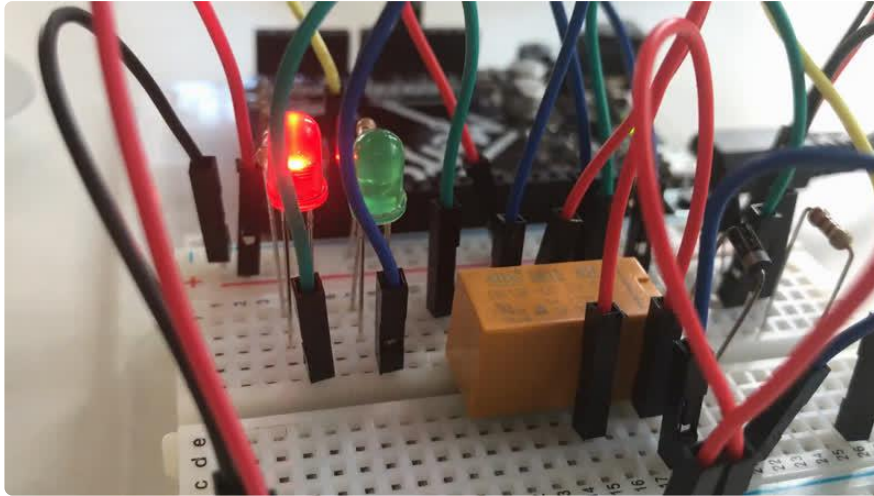

This next circuit is a bit of a challenge. We combine what we learned about using transistors in CIRC03 to control a relay.

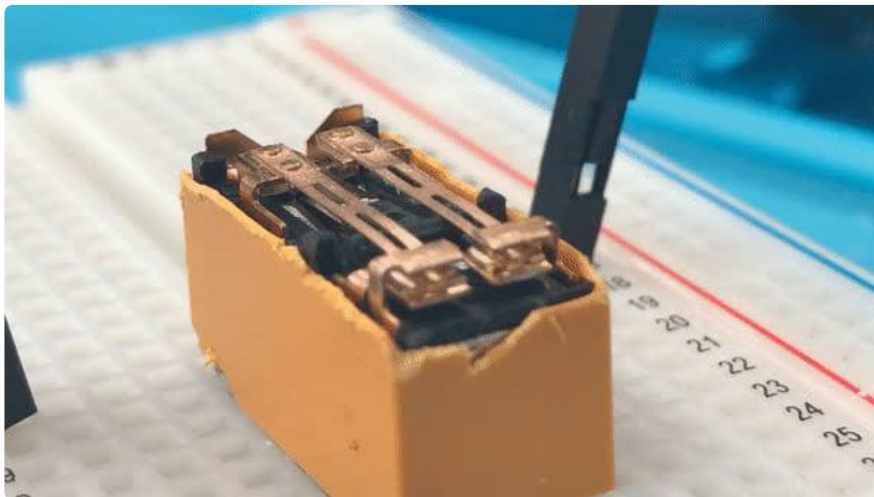

A relay is an electrically controlled mechanical switch. Inside the little plastic box is an electromagnet that, when energized, causes a switch to trip (often with a very satisfying clicking sound). You can buy relays that vary in size from a quarter of the size of the one in this kit up to as big as a fridge, each capable of switching a certain amount of current. They are immensely fun because there is an element of the physical to them.

While all the silicon we've played with to this point is fun sometimes, you may just want to wire up a hundred switches to control something magnificent. Relays give you the ability to dream it up then control it with your Arduino. Now onto using today's technology to control the past. ([The 1N4001 diode is acting as a flyback diode \(\)](#), click here for more info about flyback diodes)

Parts

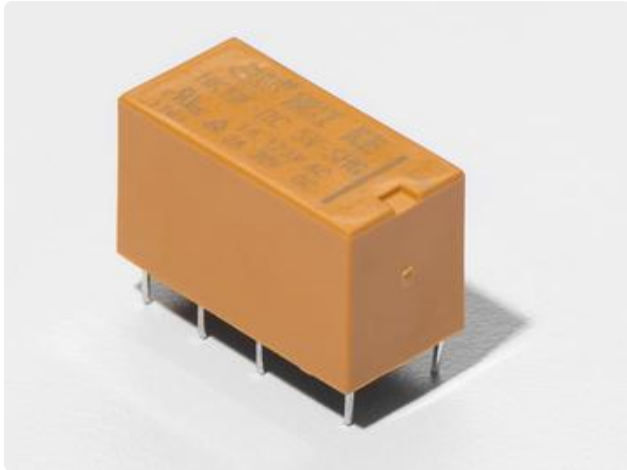

DPDT Relay



560 Ohm Resistor

QTY: x2

Colors: Green > Blue > Brown

If you'd like to order more resistors from the Adafruit shop click [here!](#) (they are 470ohm but they'll be fine) ()



2.2k Ohm Resistor

Colors: Red > Red > Red

If you'd like to order extra 2.2k Ohm resistors from the Adafruit shop, click [here!](#) ()

This circuit uses a NPN Transistor, NOT a TMP36 Sensor.

Am I using a NPN Transistor or a TMP36 Temperature Sensor? ()



Transistor (PN2222 or MPS2222)

If you'd like to order extra NPN transistors from the Adafruit shop, [click here!](#) ()



Diode (1N4001)

If you'd like to order more diodes from the Adafruit shop, [click here!](#) ()



5mm Red LED

If you'd like to order more red LEDs (they make great indicator lights!) from the Adafruit shop, [click here!](#) ()



5mm Green LED

If you'd like to order extra green LEDs from the Adafruit shop, click here! ([link](#))

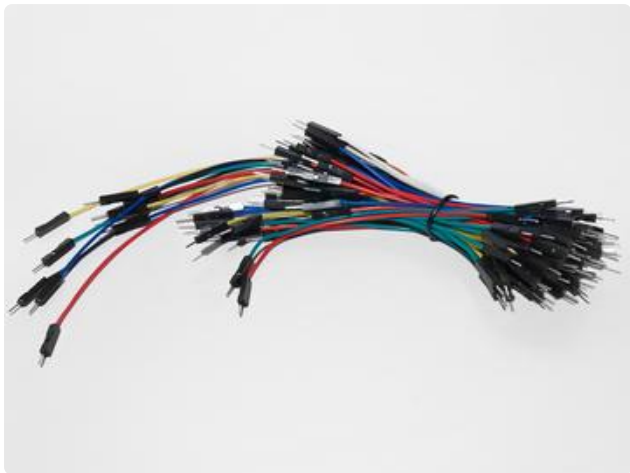

Breadboard Wiring Bundle

If you'd like to order more wires from the Adafruit shop click here! ([link](#))

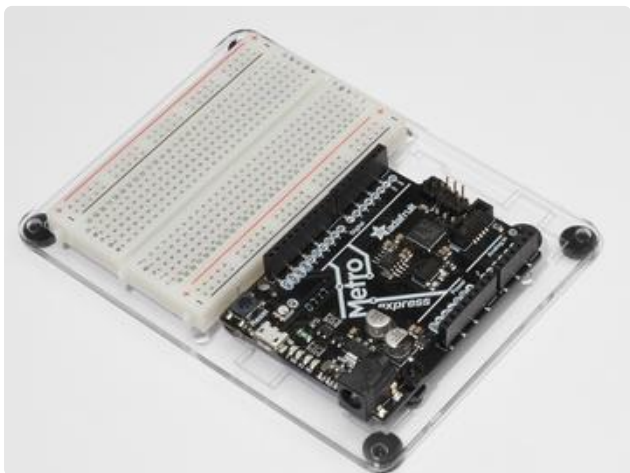

Adafruit Metro (or Metro Express) + Breadboard + Mounting Plate
If you have not assembled this, we have a handy guide! ([link](#))

If you'd like to order an extra plastic mounting plate ([link](#)), Adafruit Metro ([link](#)), Adafruit Metro Express ([link](#)), or Mini-Breadboard ([link](#)) from the Adafruit Shop click here!

Wiring

Wire it up:

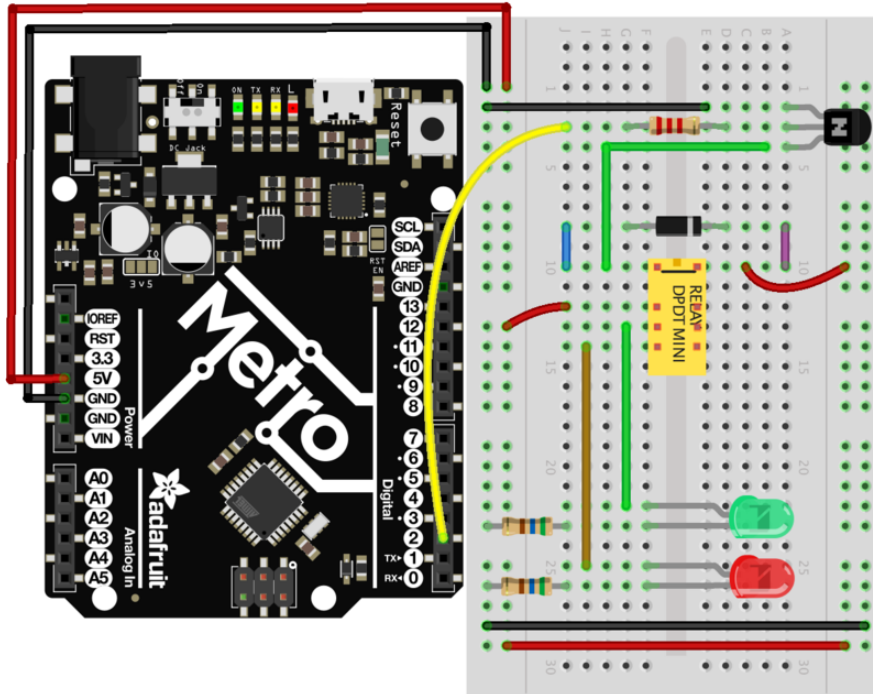

Make sure that the flat side of the transistor is facing the Metro.

Close-up of the relay wiring

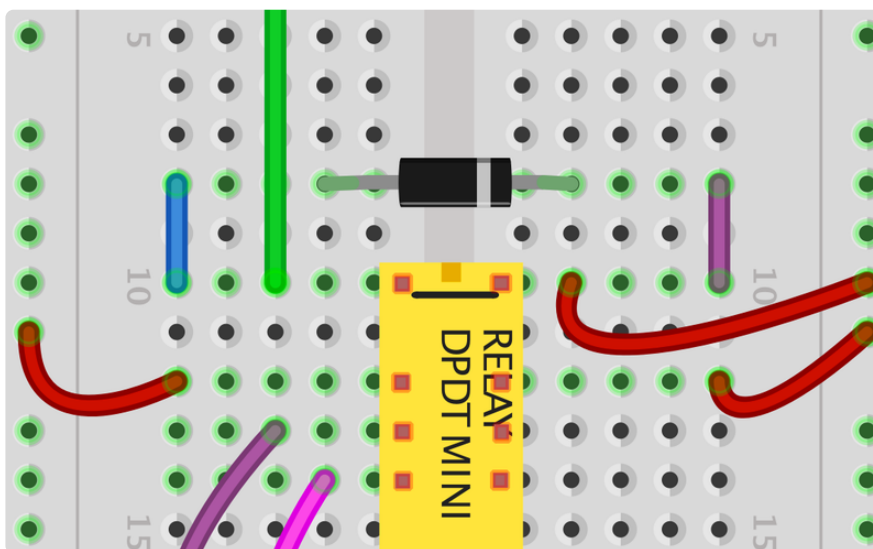

Make sure the small square at the top of the DPDT Relay faces the top of the breadboard. Also, ensure the stripe on the diode faces the right side of the DPDT Relay.

Printable Breadboard Layout Sheet

Click here to download the printable Breadboard Layout Sheet for CIRC11

Code

Copy and paste the code below into a blank Arduino sketch. Then [compile and upload it to your Metro \(\)](#).

```
// CIRC11 - Relay
int relayPin = 2;

void setup() {
  pinMode(relayPin, OUTPUT);
}

void loop() {
  digitalWrite(relayPin, HIGH);
  delay(1000);
  digitalWrite(relayPin, LOW);
  delay(1000);
}
```

Not Working?

Nothing is happening

The example code uses pin 13 and we have the relay connected to pin 2. Make sure you made this change in the code:

```
LED_BUILTIN -> 2
```

No clicking sound

The transistor or coil portion of the circuit isn't quite working. Check the transistor is plugged in the right way.

Not quite working, or not working correctly

The included relays are designed to be soldered rather than used in a breadboard. As such you may need to press it in to ensure it works (and it may pop out occasionally).

Make It Better

Check out the Back-EMF Pulse

Replace the diode with an LED. You'll see it blink each time it "snubs" the coil voltage spike when it turns off.

Controlling a Motor

In CIRC-03 we controlled a motor using a transistor. However if you want to control a larger motor a relay is a good option. To do this, simply remove the red LED and connect the motor in its place.

Controlling Motor Direction

A bit of a complicated improvement to finish. To control the direction of spin of a DC motor we must be able to reverse the direction of current flow through it. To do this manually we reverse the leads. To do it electrically we require something called an h-bridge. This can be done using a DPDT relay to control the motor's direction, wire up the following circuit. It looks complicated but can be accomplished using only a few extra wires. Give it a try.

Schematic Layout

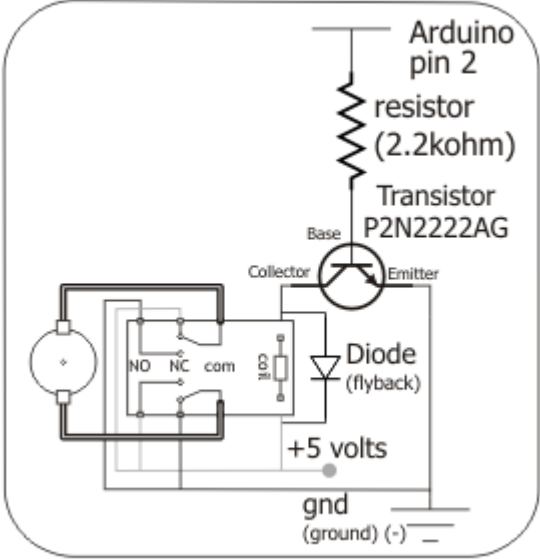

Breadboard Layout

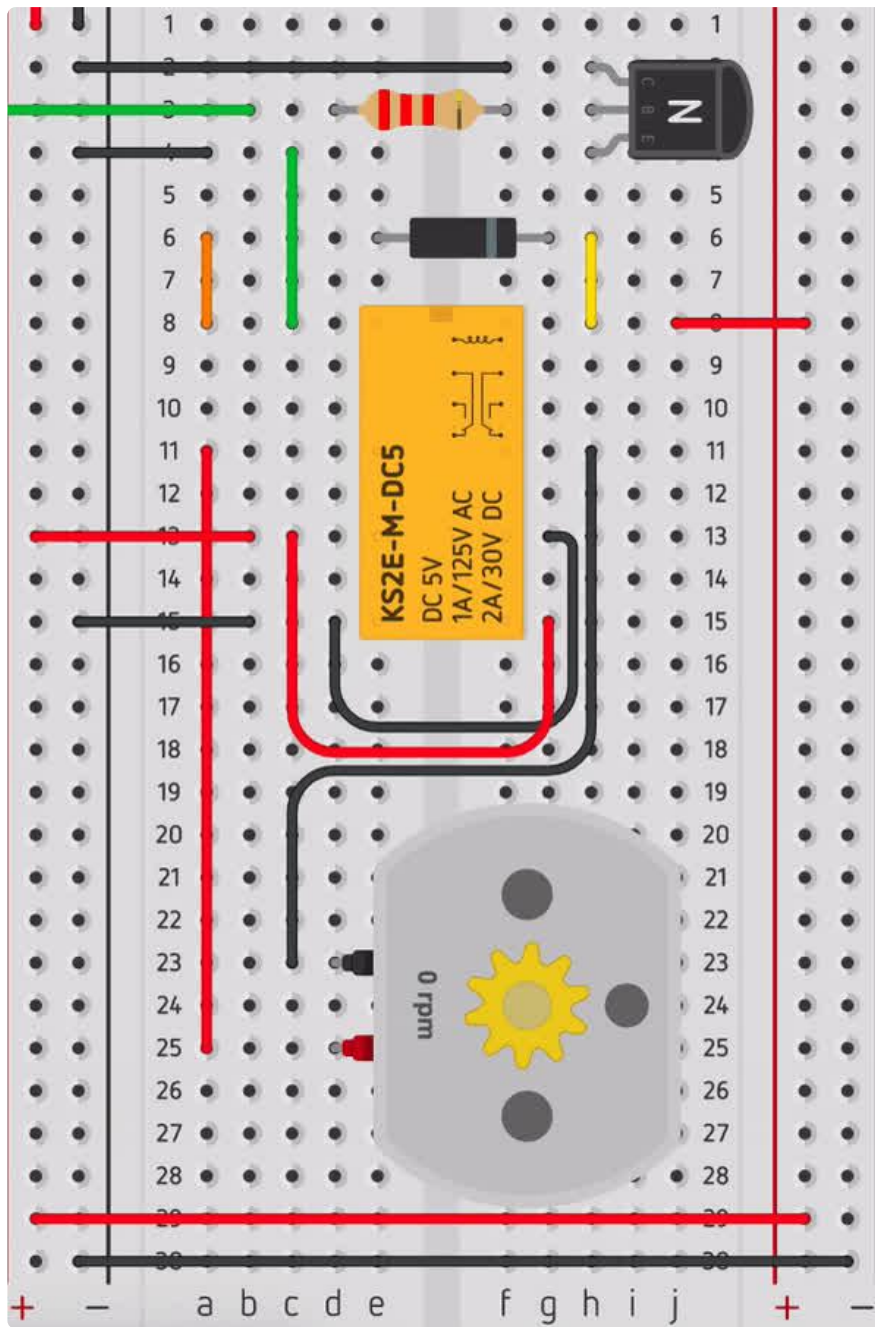

CIRC12: Colorful Light

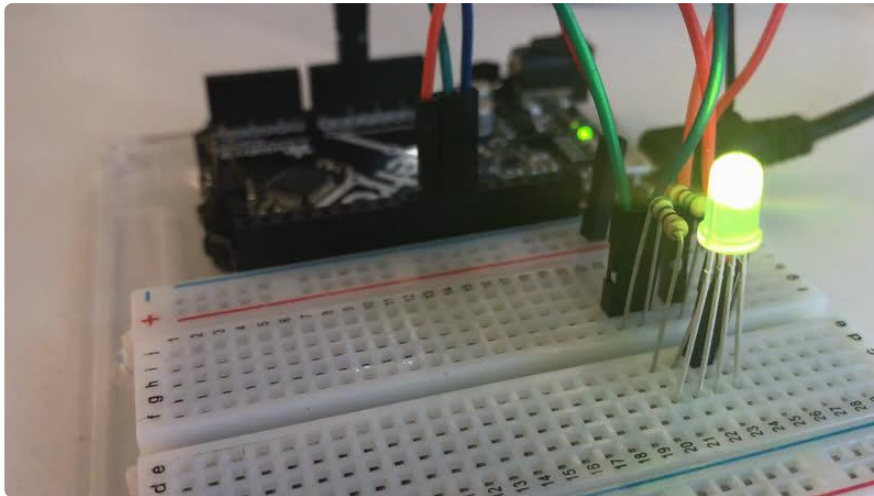

We've blinked an LED and controlled eight in sequence. Now it's time to control color. Using an RGB LED (actual 3 LEDs in a single housing) we can generate any color our heart desires.

Color Truth Table			
red	green	blue	
ON	ON	OFF	yellow
OFF	ON	ON	cyan
ON	OFF	ON	magenta
ON	ON	ON	white

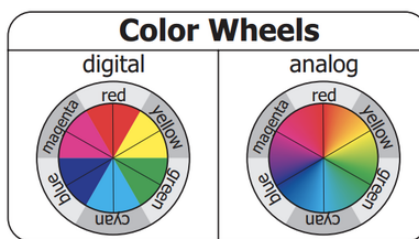

We do this through color mixing, what's required is delving back to your elementary art days of playing with colored cellophane to produce different colors (if you can't remember that far back don't worry here's a color wheel to help you out).

Parts



RGB LED

If you'd like to pick up another RGB LED from the [Adafruit Shop](#), click here. ()



560 Ohm Resistor

QTY: x3

Colors: Green > Blue > Brown

If you'd like to order more resistors from the Adafruit shop click [here!](#) (they are 470ohm but they'll be fine) ()

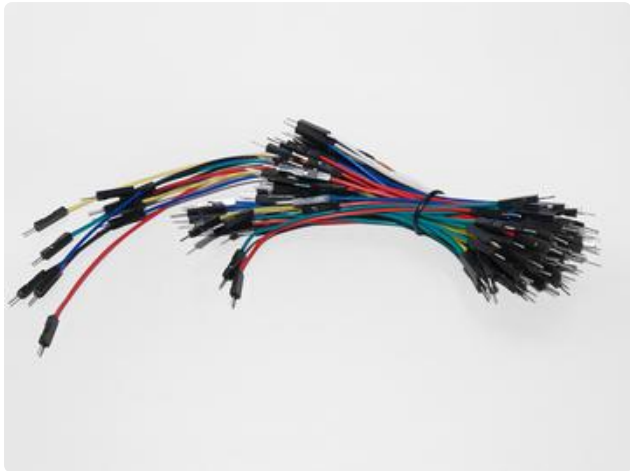

Breadboard Wiring Bundle

If you'd like to order more wires from the Adafruit shop click [here!](#) ()

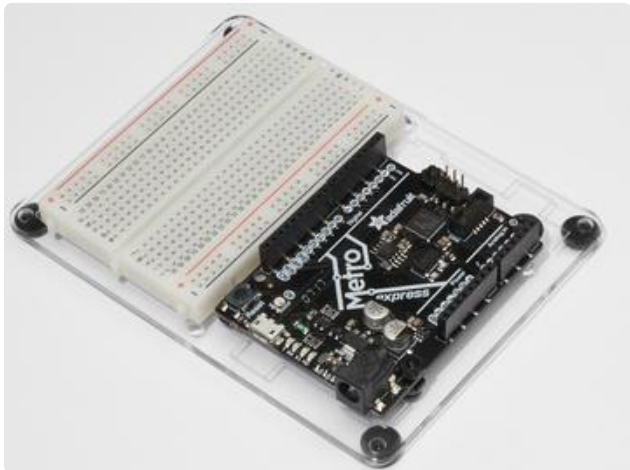

Adafruit Metro (or Metro Express) + Breadboard + Mounting Plate
If you have not assembled this, we have a [handy guide!](#) ()

If you'd like to order an extra plastic mounting plate (), Adafruit Metro (), Adafruit Metro Express (), or Mini-Breadboard () from the Adafruit Shop click [here!](#)

Wiring

Wire according to the diagram below:

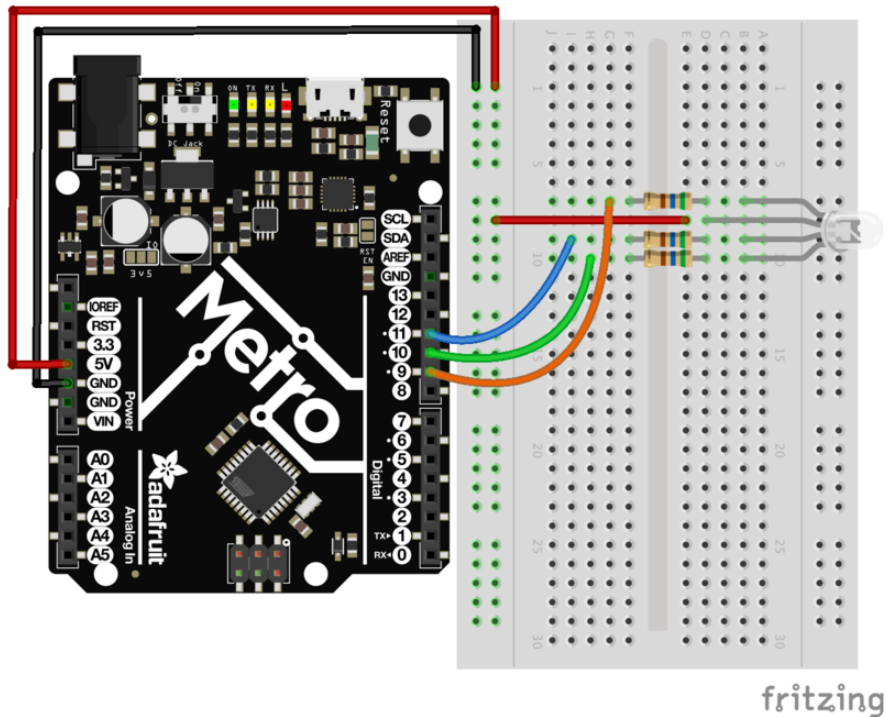

1. Connect the first RGB LED leg to a 560 ohm resistor, then Pin 9
2. Connect the second RGB LED leg to a 560 ohm resistor, then Pin 10
3. Connect the first RGB LED leg to a 560 ohm resistor, then Pin 11

Note that the longest leg of the RGB LED connects to the power rail, 5V.

Printable Breadboard Layout Sheet

Click here to download the printable Breadboard Layout Sheet for CIRC12

Wiring for Metro Express

If you are using the [Adafruit Metro Express \(\)](#), the wiring below should be used. [If you're not sure what board you have, check this page. \(\)](#)

The power rail on your breadboard should connect to the 3.3V pin on the Metro Express

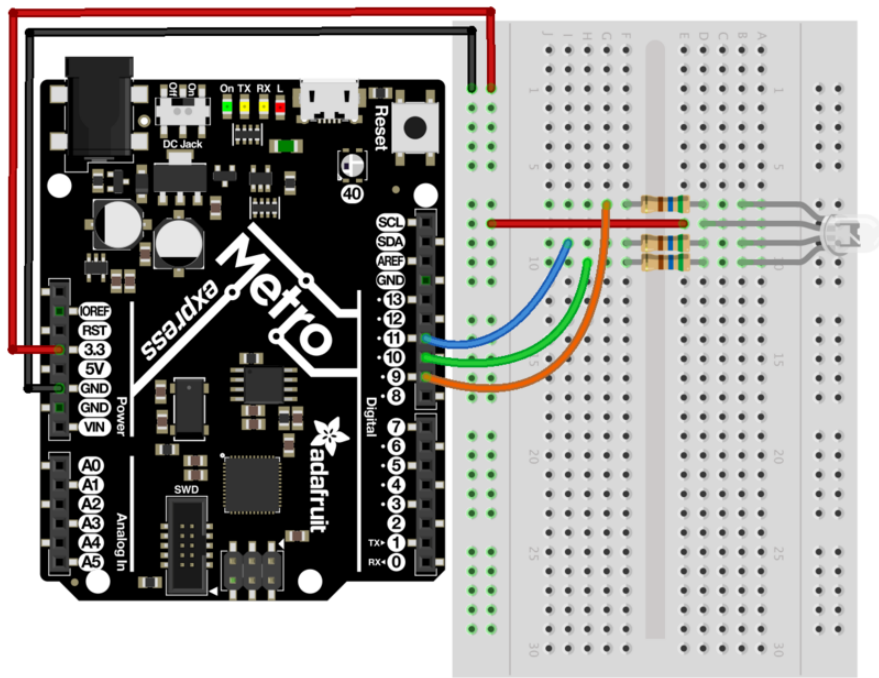

fritzing

Code

Copy and paste the code below into a blank Arduino sketch. Then [compile and upload it to your Metro](#) ().

```
// CIRC12 - RGB LED

// RGB LED PINS
// three pins:
// 9 = RED
// 10 = GREEN
// 11 = BLUE
int ledDigitalOne[] = {9, 10, 11};

// define on as low
// (because you use a common anode RGB LED)
const boolean ON = LOW;
// define off as high
const boolean OFF = HIGH;

// Predefined Colors
const boolean RED[] = {ON, OFF, OFF};
const boolean GREEN[] = {OFF, ON, OFF};
const boolean BLUE[] = {OFF, OFF, ON};
const boolean YELLOW[] = {ON, ON, OFF};
const boolean CYAN[] = {OFF, ON, ON};
const boolean MAGENTA[] = {ON, OFF, ON};
const boolean WHITE[] = {ON, ON, ON};
const boolean BLACK[] = {OFF, OFF, OFF};

//An Array that stores the predefined colors
const boolean* COLORS[] =
  {RED, GREEN, BLUE, YELLOW, CYAN, MAGENTA,
  WHITE, BLACK};

void setup() {
  for(int i = 0; i < 3; i++){
```

```
    // set the 3 pins as outputs
    pinMode(ledDigitalOne[i], OUTPUT);
  }
}

void loop() {
  // set the color of the LED
  setColor(ledDigitalOne, CYAN);
  // randomize it
  // randomColor();
}

void randomColor(){
  // get random number within range of colors
  int rand = random(0, sizeof(COLORS) / 2);
  setColor(ledDigitalOne, COLORS[rand]);
  delay(1000);
}

void setColor(int* led, const boolean* color) {
  for(int i = 0; i < 3; i++){
    digitalWrite(led[i], color[i]);
  }
}
```

Having Trouble?

LED Remains Dark or Shows Incorrect Color

With the four pins of the LED so close together, it's sometimes easy to misplace one. Try double checking each pin is where it should be.

Green and Blue seem to be reversed

Some RGB LEDs have green and blue swapped, change your code so the pins are swapped and re-upload!

Seeing Red

The red diode within the RGB LED may be a bit brighter than the other two. To make your colors more balanced, try using a higher ohm resistor (or two resistors in series).

Looking For More?

If you're looking to do more why not check out all the lovely extra bits and bobs available from the [Adafruit Shop.](#) ()

Make It Better

More Colors

I imagine you are less than impressed by the cyan glowing LED before you. To display a different color, change the color in the code to one of the others:

```
setColor(ledDigitalOne, CYAN); -> setColor(ledDigitalOne, newColor)
```

Display a Random Color

Of course we can do more than display a constant color. To see how we can cycle through random colors, change the `loop()` code to:

```
void loop() {  
  //setColor(ledDigitalOne, CYAN);  
  randomColor();  
}
```

Analog Color Control

While switching between colors is good fun, RGB LEDs really come into their own when mixed with analog control. Using PWM (pulse width modulation), it's possible to produce nearly any color and fade between them. Sadly, the code for this is a bit too long for the section above, so click below to see the code:

```
// CIRC12 - RGB LED, Analog Control  
  
//RGB LED pins  
int ledAnalogOne[] = {9, 10, 11}; //the three pins of the first analog LED 3 =  
redPin, 5 = greenPin, 6 = bluePin  
                                //These pins must be PWM  
  
//Defined Colors (different RGB (red, green, blue) values for colors  
//(to add your own ie. fuscia experiment and then add to the list)  
const byte RED[] = {255, 0, 0};  
const byte ORANGE[] = {83, 4, 0};  
const byte YELLOW[] = {255, 255, 0};  
const byte GREEN[] = {0, 255, 0};  
const byte BLUE[] = {0, 0, 255};  
const byte INDIGO[] = {4, 0, 19};  
const byte VIOLET[] = {23, 0, 22};  
const byte CYAN[] = {0, 255, 255};  
const byte MAGENTA[] = {255, 0, 255};  
const byte WHITE[] = {255, 255, 255};  
const byte BLACK[] = {0, 0, 0};  
const byte PINK[] = {158, 4, 79};
```



```

//---eof---RGLB-Analog Preamble

void setup(){
  for(int i = 0; i < 3; i++){
    pinMode(ledAnalogOne[i], OUTPUT); //Set the three LED pins as outputs
  }
  setColor(ledAnalogOne, BLACK); //Turn off led 1
}

void loop(){
/* Example 1 - Defined Colors
  Set to a known color (you can use any of the above defined colors)
*/
  setColor(ledAnalogOne, MAGENTA);

/* Example 2 - Any Color
  Set the LED to any color you like
*/
  //byte tempColor[] = {12,34,12}; //the RGB (red, green blue) value for a color to
display
  //setColor(ledAnalogOne, tempColor);

/*Example 3 - Fading
  Fade the LED between two colors (this will go from red to green to blue then back
to red)
*/
  //fadeToColor(ledAnalogOne, RED, GREEN, 10); //fadeToColor takes 4 parameters
//ledAnalogOne - an array with 3
values defining the red, green and blue pins of the LED
//RED - This is the start color
//GREEN - This is the end color
//10 - the delay (in milliseconds
between updates) (determines the fade speed)
  //fadeToColor(ledAnalogOne, GREEN, BLUE, 10); //Fades from Green to Blue
  //fadeToColor(ledAnalogOne, BLUE, RED, 10); //Fades from Blue to Red
}

/* Sets the color of the LED to any RGB Value
  led - (int array of three values defining the LEDs pins (led[0] = redPin, led[1]
= greenPin, led[2] = bluePin))
  color - (byte array of three values defining an RGB color to display (color[0] =
new Red value, color[1] = new Green value, color[2] = new Red value
*/
void setColor(int* led, byte* color){
  for(int i = 0; i < 3; i++){ //iterate through each of the three pins
(red green blue)
    analogWrite(led[i], 255 - color[i]); //set the analog output value of each pin
to the input value (ie led[0] (red pin) to 255- color[0] (red input color)
//we use 255 - the value because our RGB
LED is common anode, this means a color is full on when we output analogWrite(pin,
0)
//and off when we output analogWrite(pin,
255).
  }
}

/* A version of setColor that takes a predefined color (necessary to allow const
int pre-defined colors */
void setColor(int* led, const byte* color){
  byte tempByte[] = {color[0], color[1], color[2]};
  setColor(led, tempByte);
}

/* Fades the LED from a start color to an end color at fadeSpeed
  led - (int array of three values defining the LEDs pins (led[0] = redPin, led[1]
= greenPin, led[2] = bluePin))
  startColor - (byte array of three values defining the start RGB color
(startColor[0] = start Red value, startColor[1] = start Green value, startColor[2]
= start Red value

```

```

    endCcolor - (byte array of three values defing the finished RGB color
(endColor[0] = end Red value, endColor[1] = end Green value, endColor[2] = end Red
value
    fadeSpeed - this is the delay in milliseconds between steps, defines the speed
of the fade
*/
void fadeToColor(int* led, byte* startColor, byte* endColor, int fadeSpeed){
    int changeRed = endColor[0] - startColor[0];           //the
difference in the two colors for the red channel
    int changeGreen = endColor[1] - startColor[1];        //the
difference in the two colors for the green channel
    int changeBlue = endColor[2] - startColor[2];         //the
difference in the two colors for the blue channel
    int steps = max(abs(changeRed),max(abs(changeGreen), abs(changeBlue))); //make
the number of change steps the maximum channel change

    for(int i = 0 ; i < steps; i++){                       //iterate
for the channel with the maximum change
        byte newRed = startColor[0] + (i * changeRed / steps); //the
newRed intensity dependant on the start intensity and the change determined above
        byte newGreen = startColor[1] + (i * changeGreen / steps); //the
newGreen intensity
        byte newBlue = startColor[2] + (i * changeBlue / steps); //the
newBlue intensity
        byte newColor[] = {newRed, newGreen, newBlue};      //Define
an RGB color array for the new color
        setColor(led, newColor);                            //Set the
LED to the calculated value
        delay(fadeSpeed);                                   //Delay
fadeSpeed milliseconds before going on to the next color
    }
    setColor(led, endColor);                                //The LED
should be at the endColor but set to endColor to avoid rounding errors
}

/* A version of fadeToColor that takes predefined colors (necessary to allow const
int pre-defined colors */
void fadeToColor(int* led, const byte* startColor, const byte* endColor, int
fadeSpeed){
    byte tempByte1[] = {startColor[0], startColor[1], startColor[2]};
    byte tempByte2[] = {endColor[0], endColor[1], endColor[2]};
    fadeToColor(led, tempByte1, tempByte2, fadeSpeed);
}

```

CIRC13: Squeezing

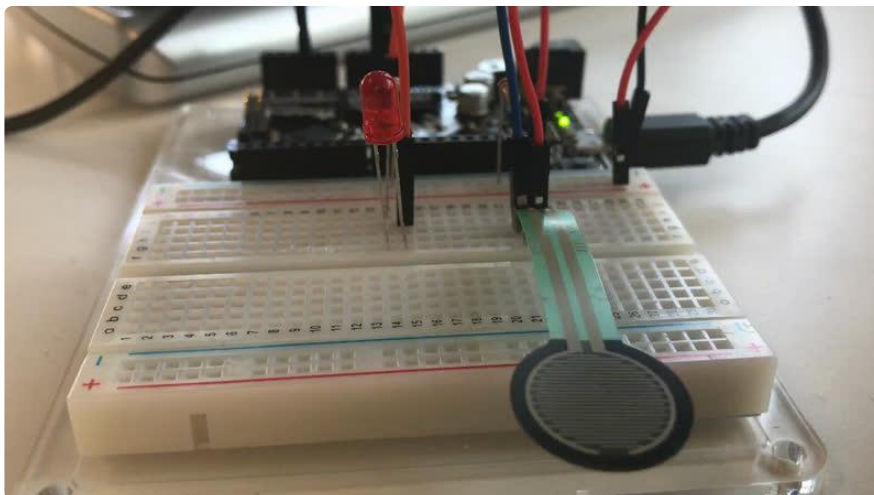

Force Sensitive Resistors (FSRs) are sensors that allow you to detect the pressure exerted on them. They're similar to a potentiometer (like in CIRC08), except instead of varying resistance by twisting, the FSR's resistance varies with pressure.

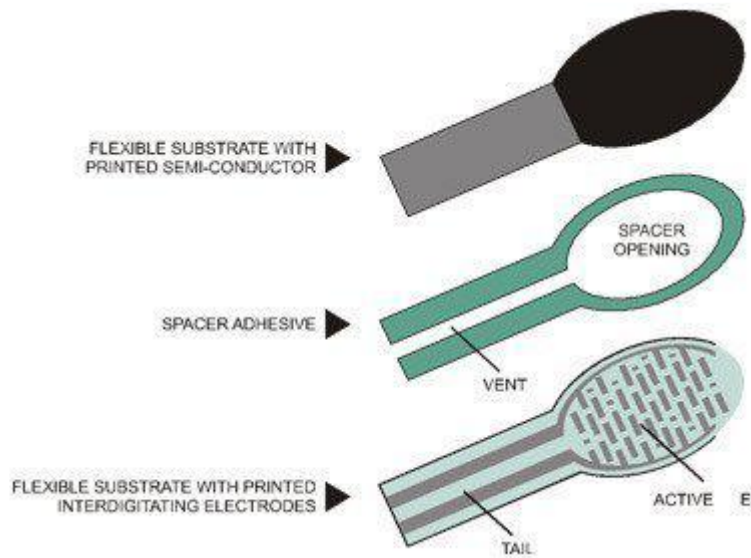

The FSR is made of 2 layer separated by a spacer. The more you press, the more dots on the active element touch the semiconductor, and that makes the resistance go down. They're not good for detecting exact weight, but they're great for detecting squeezing and pushing and poking. [If you'd like to dive a bit deeper into how FSRs exactly work, ladyada has a great learn guide which goes over more technical details.](#)
()

Parts



Force Sensitive Resistor

If you'd like to order a force sensitive resistor from the Adafruit shop, [click here!](#) ()



10K Ohm Resistor

Colors: Brown > Black > Orange

If you'd like to order more 10k ohm pull-up resistors from the Adafruit shop, click [here!](#) ()



5mm Green LED

If you'd like to order extra green LEDs from the Adafruit shop, click [here!](#) ()



560 Ohm Resistor

Colors: Green > Blue > Brown

If you'd like to order more resistors from the Adafruit shop click [here!](#) (they are 470ohm but they'll be fine) ()

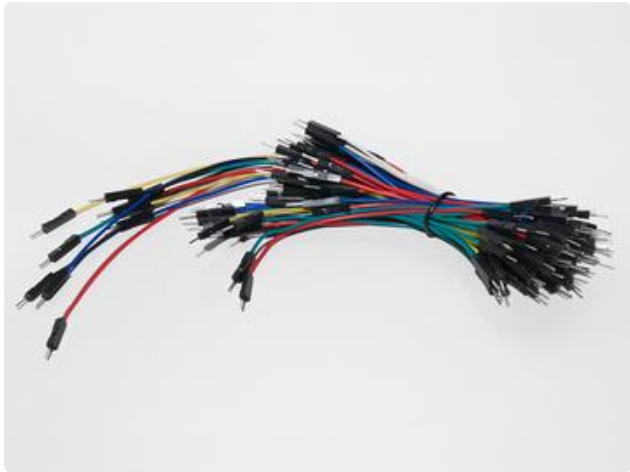

Breadboard Wiring Bundle

If you'd like to order more wires from the Adafruit shop click [here!](#) ()

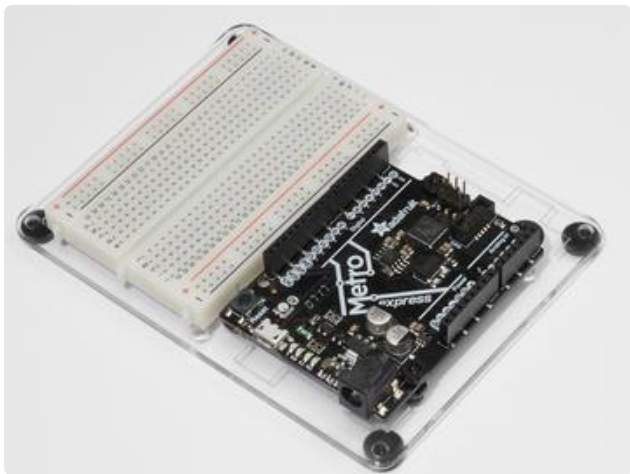

Adafruit Metro (or Metro Express) + Breadboard + Mounting Plate
If you have not assembled this, we have a [handy guide!](#) ()

If you'd like to order an extra plastic mounting plate (), Adafruit Metro (), Adafruit Metro Express (), or [Mini-Breadboard](#) () from the Adafruit Shop click [here!](#)

Wiring

The wiring for this circuit is the same for the Metro and the Metro Express. Note that the power rail is connected to 3V instead of 5V.

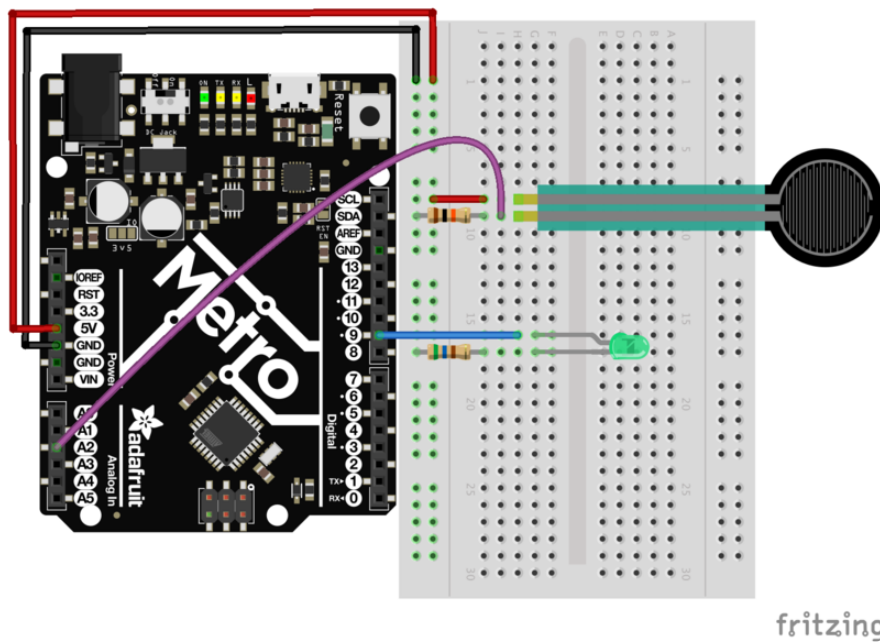

The last circuit is easy to build, but really fun to use:

1. One end of the Force Sensitive Resistor (FSR) connects to the power rail.
2. The other end of the FSR connects to analog pin 2 and a 10k ohm pull-up resistor.
3. Connect a red LED to pin 9 and a 560 ohm current-limiting resistor.

Printable Breadboard Layout Sheet

[Click here to download the printable Breadboard Layout Sheet for CIRC13](#)

Code

Copy and paste the code below into a blank Arduino sketch. Then [compile and upload it to your Metro](#) ().

```

/*
 * Force Sensitive Resistor Test Code
 *
 * The intensity of the LED will vary with the amount of pressure on the sensor
 */
int sensePin = 2; // the pin the FSR is attached to
int ledPin = 9; // the pin the LED is attached to (use one capable of PWM)
void setup() {
  Serial.begin(9600);
  pinMode(ledPin, OUTPUT); // declare the ledPin as an OUTPUT
}
void loop() {
  int value = analogRead(sensePin) / 4; //the voltage on the pin divided by 4 (to
  //scale from 10 bits (0-1024) to 8 (0-255)

```

```
analogWrite(ledPin, value); //sets the LEDs intensity proportional to
//the pressure on the sensor
Serial.println(value); //print the value to the debug window
}
```

Not Working?

LED Not Lighting Up?

LEDs will only work in one direction. Try taking it out and twisting it 180 degrees. (no need to worry, installing it backwards does no permanent harm).

Fading to Fast/Slow

This is a result of the FSR's response to pressure not being quite linear. But do not fear it can be changed in code (check out the details in the Making it Better section)

Looking For More?

You're in luck - this guide has extra CIRCUITS and a few PROJECTS included! Check the sidebar on the left for a full listing.

Make It Better

Calibrating the Range

While the light is now fading, chances are its response isn't quite perfect. To adjust the response, we need to add one more line to our code:

```
map(value, fromLow, fromHigh, toLow, toHigh)
```

To calibrate our sensor, we can use the serial monitor like in CIRC-11. Open the serial monitor, then replace the `fromLow` value with the value display when the sensor is fully pressed.

Then, replace the `fromHigh` value with the unpressed value.

Finally, fill in the range `toLow = 0` and `toHigh = 255`

The result will look something like this:

```
int value = analogRead(sensePin);
map(value, 125, 854, 0, 255);
analogWrite(ledPin, value);
```

The RGB Strongperson Test

Step right up to test your strength against the Adafruit Metro [High Striker Game! \(\)](#) Only the strongest will succeed! Let's quickly modify the circuit with a RGB LED to indicate strength-level and modify the code to display how hard someone is pressing the force-sensitive resistor.

Diagram: RGB + Force Resistor

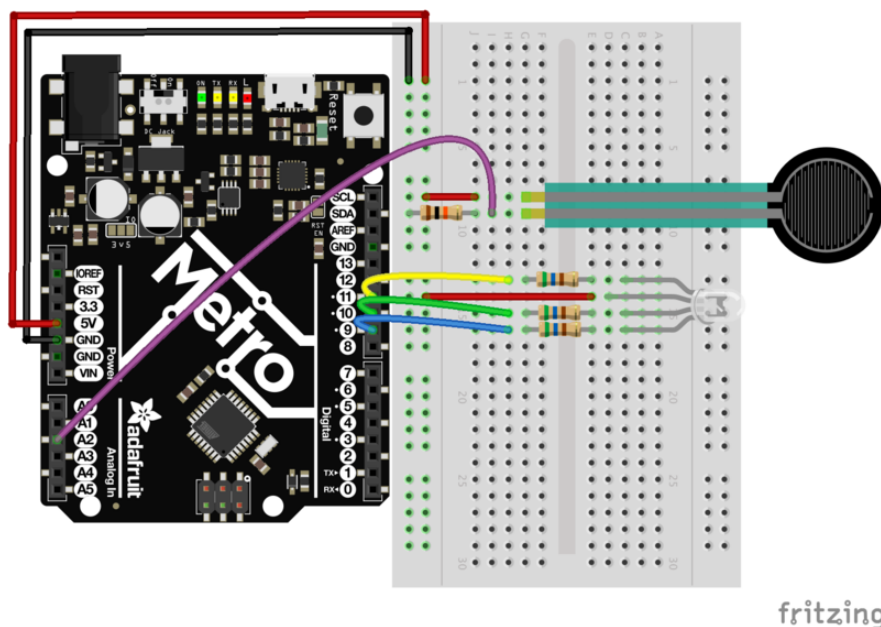

The code below will need to be first run, and then modified. After running it, open the Serial Monitor and press the force sensitive resistor as hard as possible. The value printed is the maxForce that someone could press on the FSR on your circuit. Set maxForce to the value in your serial monitor:

```
// set maxForce
int maxForce = FORCEVALUE;
```

After setting the maxForce, try your luck! We've included a serial printout to show how hard you're depressing the FSR.

```
/*
 FSR Strongperson Test for Metro (and Metro Express)

 Utilizes a FSR and a RGB LED to test how strong you are.
```

Created 7 July 2017
By Brent Rubell for Adafruit Industries
Support Open Source ~ buy Adafruit

```
*/

// fsr pin
int sensePin = A2;
// rgb led pins
int rgbLED[] = {9, 10, 11};

// common cathode rgbleds
const boolean ON = LOW;
const boolean OFF = HIGH;

// predefined colors
const boolean BLUE[] = {ON, OFF, OFF};
const boolean RED[] = {OFF, OFF, ON};
const boolean GREEN[] = {OFF, ON, OFF};

void setup() {
  Serial.begin(9600);

  // set all rgb pins as outputs
  for(int i = 0; i<3; i++){
    pinMode(rgbLED[i], OUTPUT);
  }
}

void loop() {
  // scale voltage down to 255 from 1023
  int force = analogRead(sensePin) / 4;
  // check maximum force by squeezing the FSR
  Serial.println(force);

  // set maxForce
  int maxForce = 160;

  // calculate regions
  int lowForce = maxForce / 3;
  int medForce = (maxForce / 3) * 2;
  // check force regions
  if(force < lowForce) {
    Serial.println("easy");
    setColor(rgbLED, RED);
  }
  else if (force > lowForce && force < medForce) {
    Serial.println("medium");
    setColor(rgbLED, BLUE);
  }
  else {
    Serial.println("hard");
    setColor(rgbLED, GREEN);
  }
}

// rgb color mixing
void setColor(int* led, const boolean* color) {
  for(int i = 0; i < 3; i++){
    digitalWrite(led[i], color[i]);
  }
}
```

Other Applications

With sensors, the real fun comes in how you use them in neat and unexpected ways. So get thinking about how and where sensing force could enhance your life (or the life of others).

CIRC14: Character LCDs

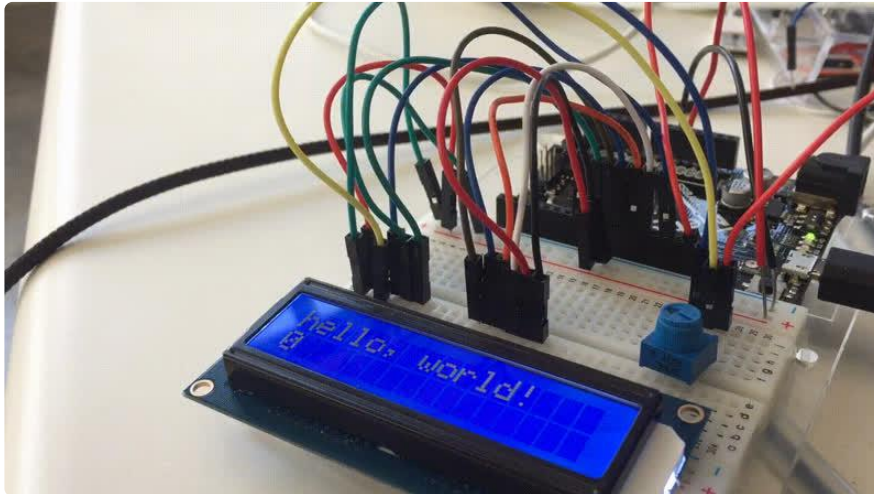

[We carry a slew of different types of Character LCDs in the Adafruit Store \(\)](#). The Experimenter's kit provides one, but [if you don't have one, the 16x2 variety is used \(\)](#) in the Experimenter's guide.

Character LCDs are super useful for displaying text, data, variable information or providing an interface to interact with. You've already used the Serial Monitor in previous learn guides. While it's useful to display data from the Metro, it needs to be tethered to the computer via USB. The character LCD lets you have a free-standing display for whatever you want to print - text, data, and even small icons (5px x 7px)

Parts



16x2 Character LCD

If you'd like to buy a white-on-blue 16x2 character lcd from the Adafruit shop, click [here!](#) ()

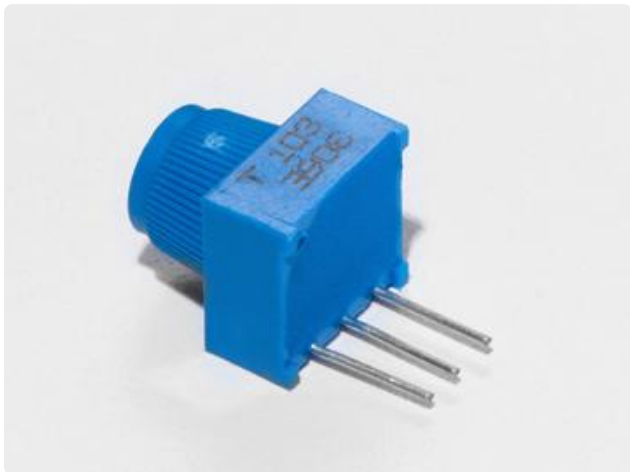

Breadboard Trim Potentiometer - 10k

If you'd like to buy an extra trimpot from the Adafruit store, click [here!](#) ()



Breadboard Wiring Bundle

If you'd like to order more wires from the Adafruit shop click [here!](#) ()

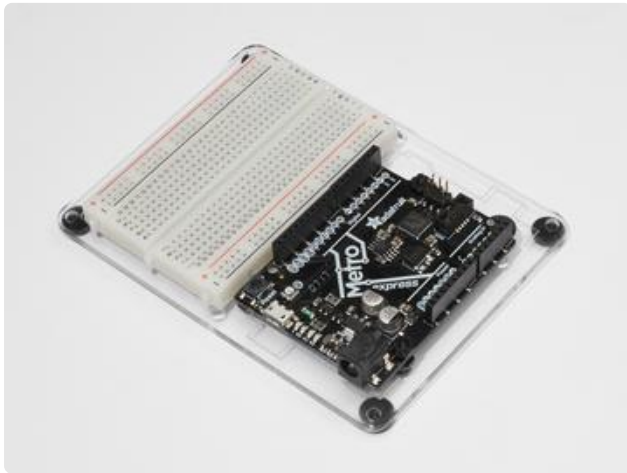

Adafruit Metro (or Metro Express) + Breadboard + Mounting Plate
If you have not assembled this, we have a handy guide! ()

If you'd like to order an extra plastic mounting plate (), Adafruit Metro (), Adafruit Metro Express (), or Mini-Breadboard () from the Adafruit Shop click here!

Wiring

The instructions and wiring on this page is based off of [ladyada's wonderful Character LCD wiring guide, \(\)](#) but updated for Fritzing.

Assembling your LCD

Some 16x2 LCDs may come assembled, meaning the header is already soldered on:

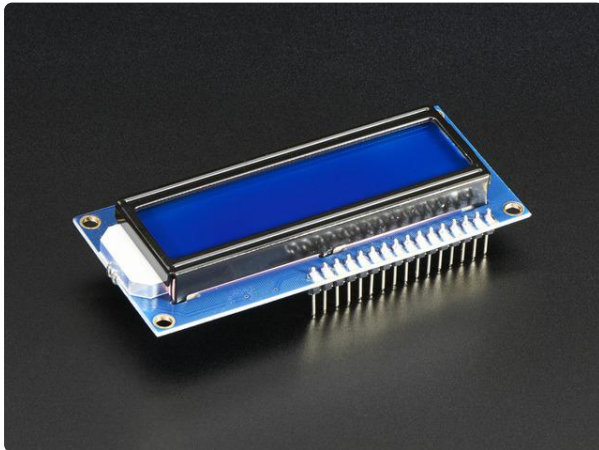

[Assembled Standard LCD 16x2 + extras - White on Blue](#)

Standard HD44780 LCDs are useful for creating standalone projects. This product is similar to our Standard LCD 16x2 display...

<https://www.adafruit.com/product/1447>

We also have some that are unassembled with an unsoldered header:

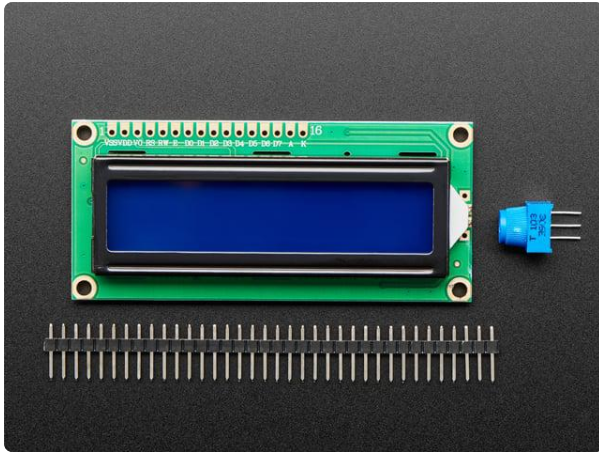

Standard LCD 16x2 + extras

Standard HD44780 LCDs are useful for creating standalone projects. 16 characters wide, 2 rows. White text on blue background. Connection port is 0.1"...

<https://www.adafruit.com/product/181>

If your LCD is assembled, you can skip these next steps and proceed directly to wiring it up. Otherwise, follow along below.

Soldering your LCD

Soldering is a very useful skill in the realm of electronics. It's the process of joining two metals together, using another piece of metal (also known as solder) between them. If you have never done this before, Bill Earl wrote an awesome visual guide entitled *Adafruit Guide To Excellent Soldering* which will get you off the ground, fast. If you would prefer to watch a video, Collin's Lab covers soldering, too:

The 16x2 LCD is not that hard to solder, but it does have a lot of pins. We have some advice for soldering these like a pro:

Start by plugging your 16x2 LCD and header into your breadboard.

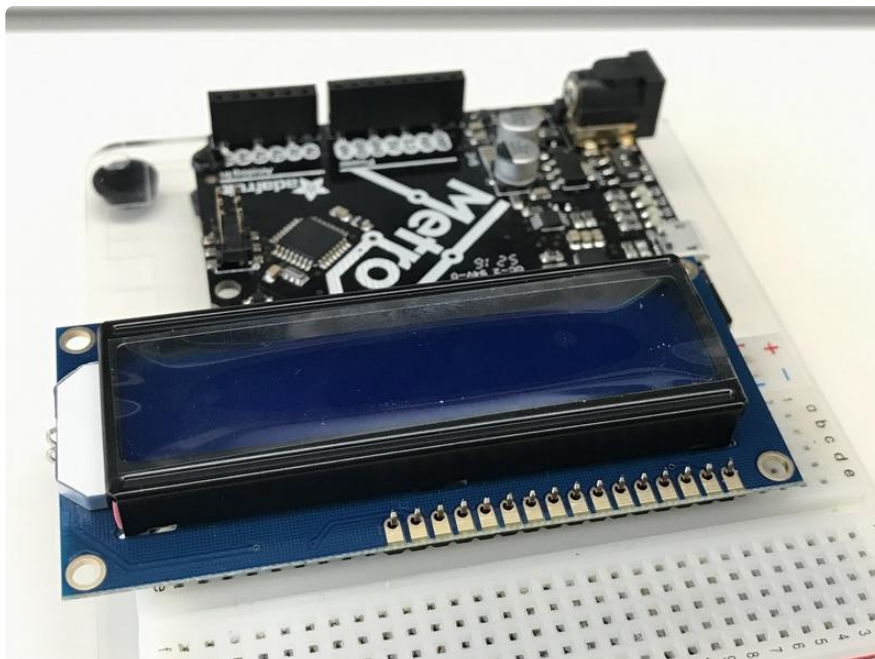

Then, (with a medium-level of heat, dont make your iron too hot!) start soldering Pin 1 to the header. Next solder Pin 16. This will "tack" the header to the LCD, making soldering the rest of the pins easier.

Now, go solder all the other pins!

Messed up? Issues with your header? Soldering is very fix-able. It'll just take time. Check this guide for your mistakes, and correct them before moving on.

Wiring Power and Backlight

If these photos are too small, you can right click on them -> "copy image address", then paste the address into the URL bar of your browser for a full-resolution screenshot.

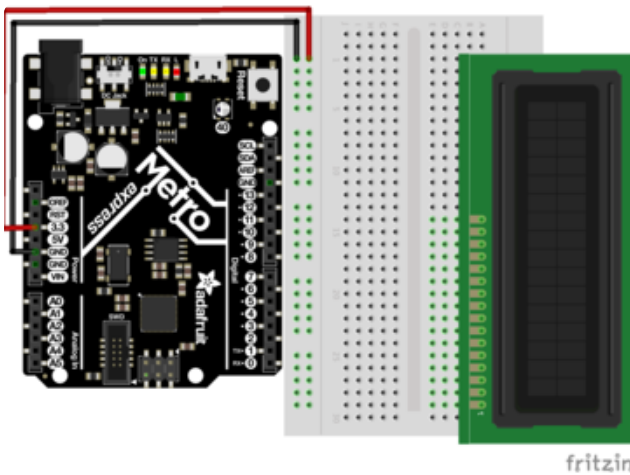

First, plug your LCD into the breadboard. Then, connect the +5V Pin to the power rail and the GND Pin to the ground rail.

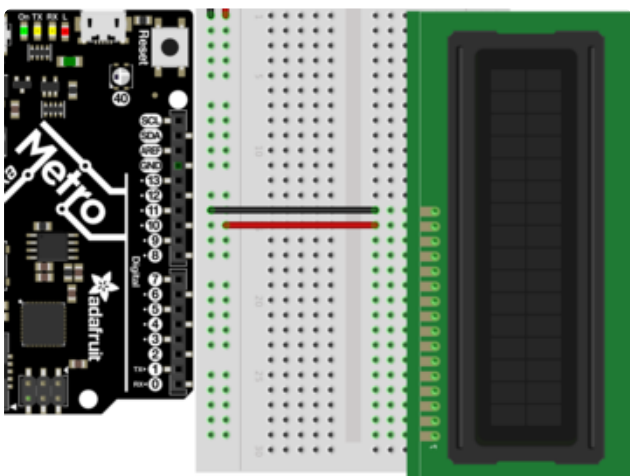

Next, connect LCD Pin 16 to the GND rail, and LCD Pin 15 to the power rail.

Do not move on until you perform a Power Check

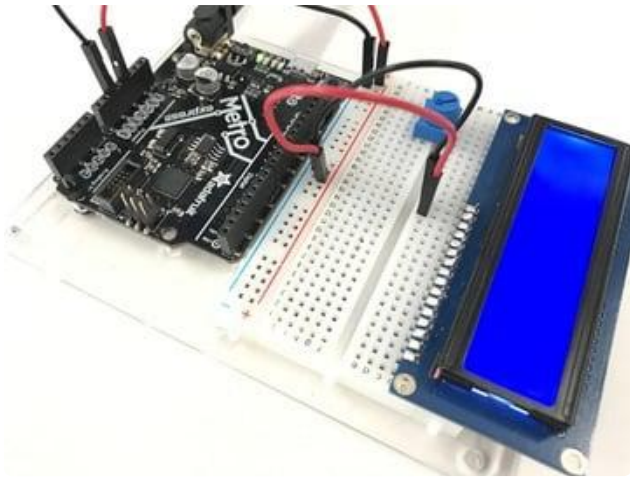

Let's check it's power. Connect your Metro or Metro Express to power. You should see the LCD light up. Some low-cost LCDs don't come with a backlight.

If you have one with a backlight and if you don't see it lighting up, go back and check over your wiring.

Wiring the Contrast Circuit

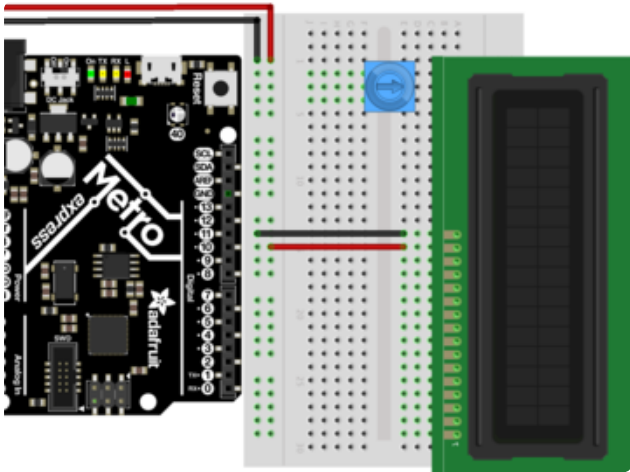

Next, let's place the contrast potentiometer to the left of LCD Pin 16. You can place it anywhere on the breadboard you'd like, but the next CIRC has it placed to the left of LCD Pin 16

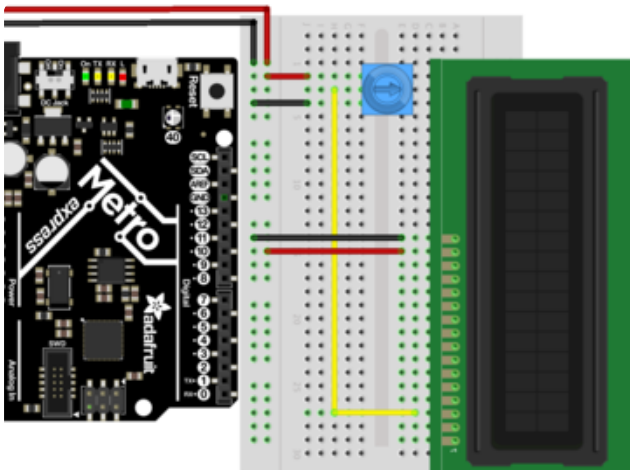

Connect one of the outer pins of the potentiometer to the power rail. Connect the other outer pin to the ground rail. It doesn't matter which goes where, the other pins are interchangeable as long as one goes to power and one goes to ground.

The middle of the potentiometer (the wiper) connects to LCD Pin 3

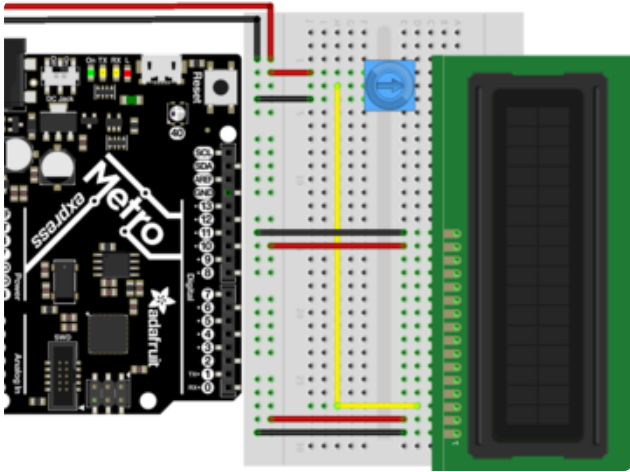

LCD Pin 1 connects to the ground rail. LCD Pin 2 connects to the power rail. These pins are the logic of the LCD.

Do not move on until you see rectangles when powered on, and the potentiometer is twisted.

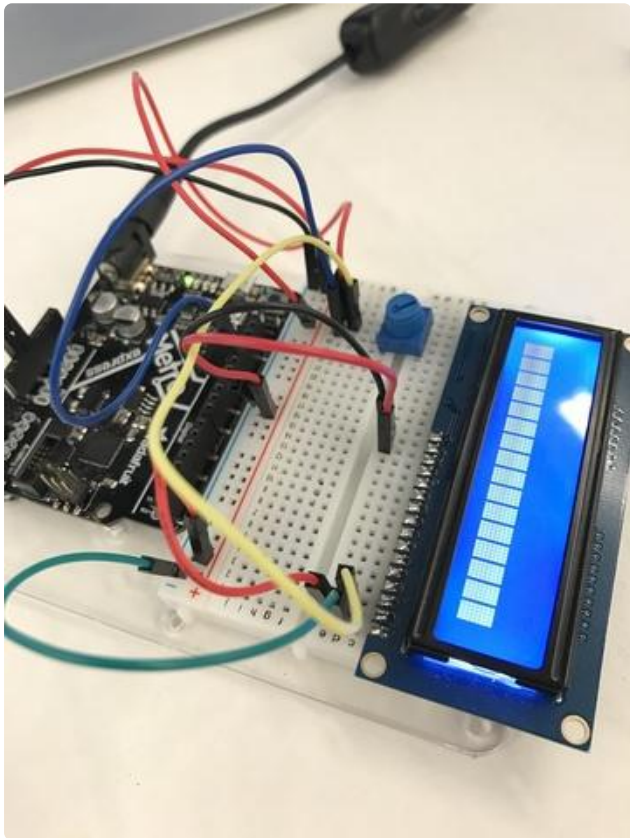

Before moving on, we'll perform a small test to make sure the wiring is correct. Plug in your Metro or Metro express and twist the potentiometer. You should see black rectangles appear on the first line of the LCD. If you don't see this, check your wiring before moving on.

Wiring the Data Bus

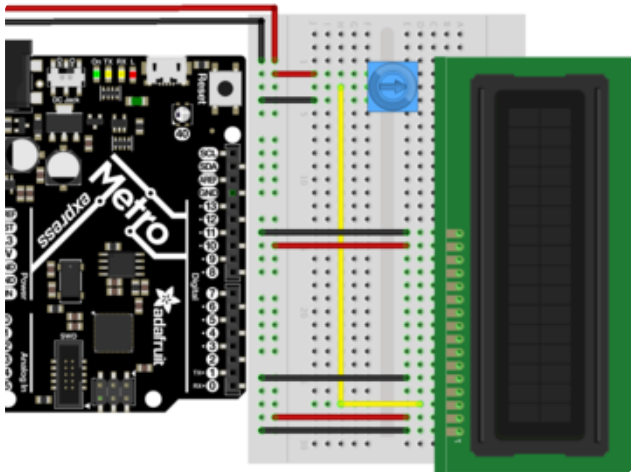

The RW Pin is not required for this guide, as we are only writing to the display. Connect LCD Pin 5 to the ground rail.

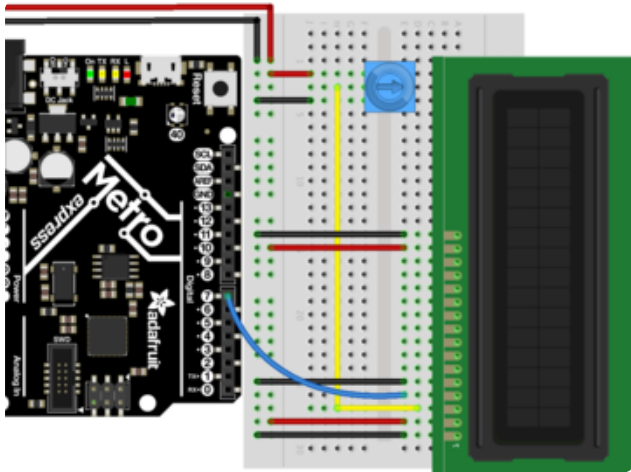

Next, we are going to connect the RS Pin. We used a blue wire to connect LCD Pin 4 to Metro Digital Pin 7

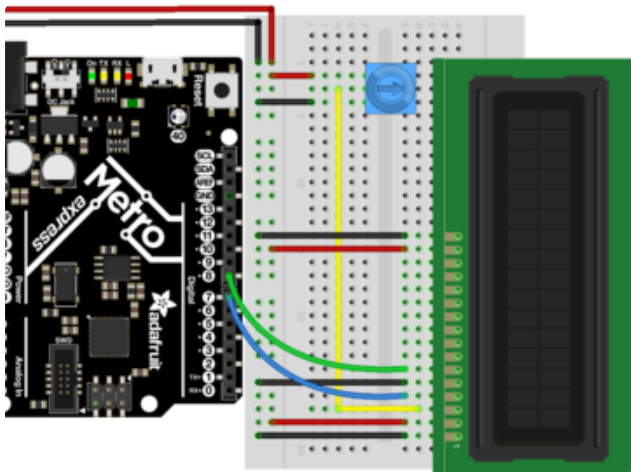

The EN Pin is next. We used a green wire to connect LCD Pin 6 to Metro Digital Pin 8

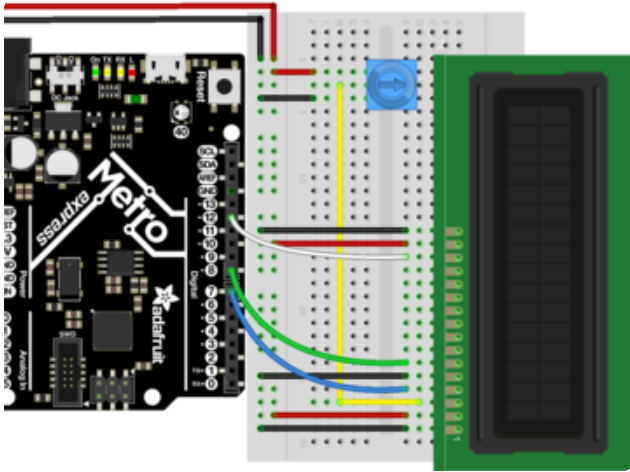

Next is the first of the data pins, DB7. We used a white wire to connect LCD Pin 14 to Metro Digital Pin 12

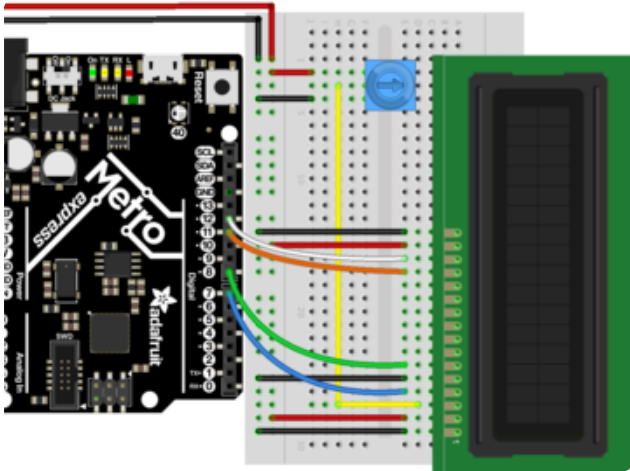

DB6 is up next. We used an orange wire to connect LCD Pin 13 to Metro Digital Pin 11

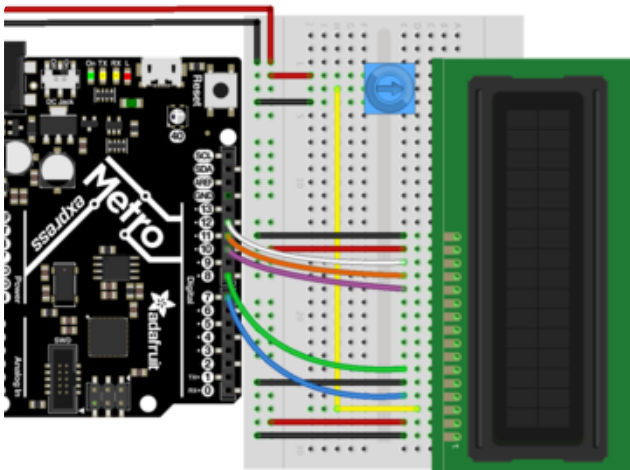

Connect DB5 (we used a purple wire)from LCD Pin 12 to Metro Digital Pin 10.

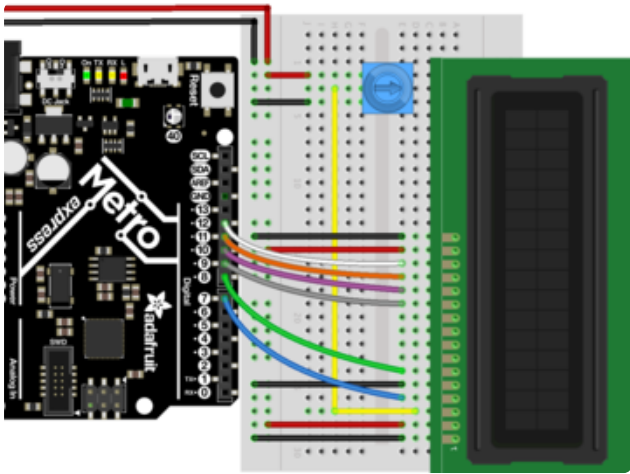

Finally, we connect DB4 with a gray wire from LCD Pin 11 to Metro Digital Pin 9

Check that you have a 4-wire gap between your data pins like this:

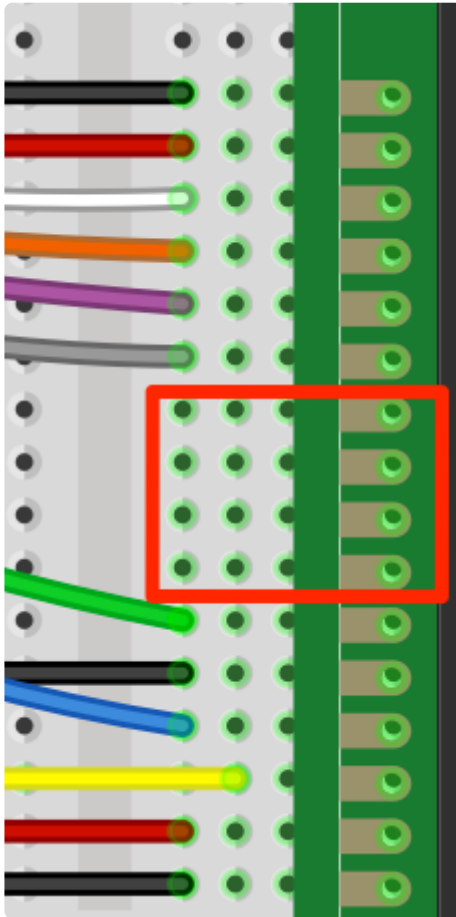

This is what you should have on your desk, proceed to the code section after double-checking your wiring:

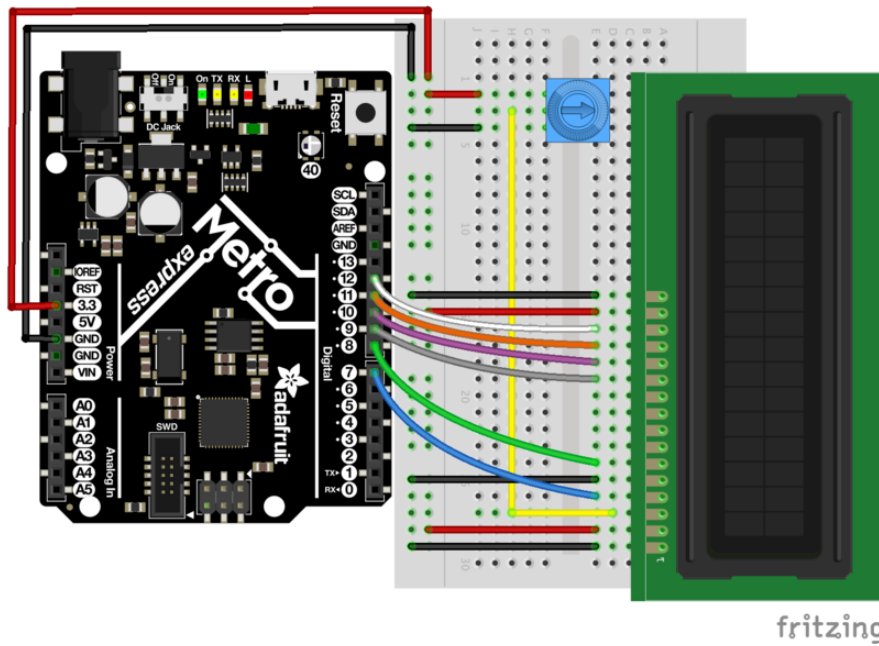

Code

Copy and paste the code below into a new Arduino sketch. Then, compile and upload it to your Metro or Metro Express.

Do NOT take this CIRC apart just yet...CIRC15 uses the LCD and you don't want to wire it up again.

```

/*
  LiquidCrystal Library - Hello World

  Demonstrates the use a 16x2 LCD display.  The LiquidCrystal
  library works with all LCD displays that are compatible with the
  Hitachi HD44780 driver. There are many of them out there, and you
  can usually tell them by the 16-pin interface.

  This sketch prints "Hello World!" to the LCD
  and shows the time.

  The circuit:
  * LCD RS pin to digital pin 7
  * LCD Enable pin to digital pin 8
  * LCD D4 pin to digital pin 9
  * LCD D5 pin to digital pin 10
  * LCD D6 pin to digital pin 11
  * LCD D7 pin to digital pin 12
  * LCD R/W pin to ground
  * LCD VSS pin to ground
  * LCD VCC pin to 5V
  * 10K resistor:
  * ends to +5V and ground
  * wiper to LCD VO pin (pin 3)

  Library originally added 18 Apr 2008
  by David A. Mellis
  library modified 5 Jul 2009
  by Limor Fried (http://www.ladyada.net)

```

```
example added 9 Jul 2009
by Tom Igoe
modified 22 Nov 2010
by Tom Igoe
```

This example code is in the public domain.

```
http://www.arduino.cc/en/Tutorial/LiquidCrystal
*/

// include the library code:
#include <LiquidCrystal.h>

// initialize the library with the numbers of the interface pins
// modified for Metro Explorers Guide
LiquidCrystal lcd(7, 8, 9, 10, 11, 12);

void setup() {
  // set up the LCD's number of columns and rows:
  lcd.begin(16, 2);
  // Print a message to the LCD.
  lcd.print("hello, world!");
}

void loop() {
}
```

Not Working?

My Character LCD is not lighting up.

[Double-check the wiring connections you made to the power and backlight pins of the Character LCD is correct \(\)](#). Check your soldering joints, [maybe they are problematic. \(\)](#)

Also check that you are using the 5v Pin instead of the 3.3V Pin.

I only see black blocks on the LCD

Try twisting your potentiometer. It's also possible that your [data bus is not hooked up correctly. \(\)](#)

I don't see anything at all

Re-wiring your LCD is a good way to get rid of any issues, it takes a lot of time but ensures everything is correct. If all else fails, [post up in the Adafruit Support Forums and we will get back to you as soon as we can. \(\)](#)

Make It Better

Writing to the second line

If we want to write to the second line, we can use `lcd.setCursor(COLUMN, LINE)` such that the column is 0 and the line is 1:

```
lcd.setCursor(0,1);
```

```
void loop() {  
  // set the cursor to column 0, line 1  
  // (note: line 1 is the second row, since counting begins with 0):  
  lcd.setCursor(0, 1);  
  // print the number of seconds since reset:  
  lcd.print(millis() / 1000);  
}
```

Do NOT take apart this CIRC yet, CIRC15 uses the LCD and you don't want to wire it up again.

Writing the light sensor to the LCD

Let's try writing the output of the light sensor to the character LCD.

This will require an extra part:



Photo Sensor

If you'd like to order another photoresistor from the [Adafruit shop](#), click here! ()

```
void loop() {  
  // read the light level  
  int lightLevel = analogRead(lightPin);  
  // map and constrain the light sensor values  
  lightLevel = map(lightLevel, 0, 900, 0, 255);  
  lightLevel = constrain(lightLevel, 0, 255);  
  
  // set the cursor to column 0, line 1  
  lcd.setCursor(0, 1);  
  // write lightLevel to the LCD  
  lcd.print(lightLevel);  
}
```

What's next?

The Thermometer (CIRC15) gets into the nitty-gritty of the character LCD. You'll learn how to display custom characters, full strings of text, and multi-line data output!

CIRC15: Thermometer

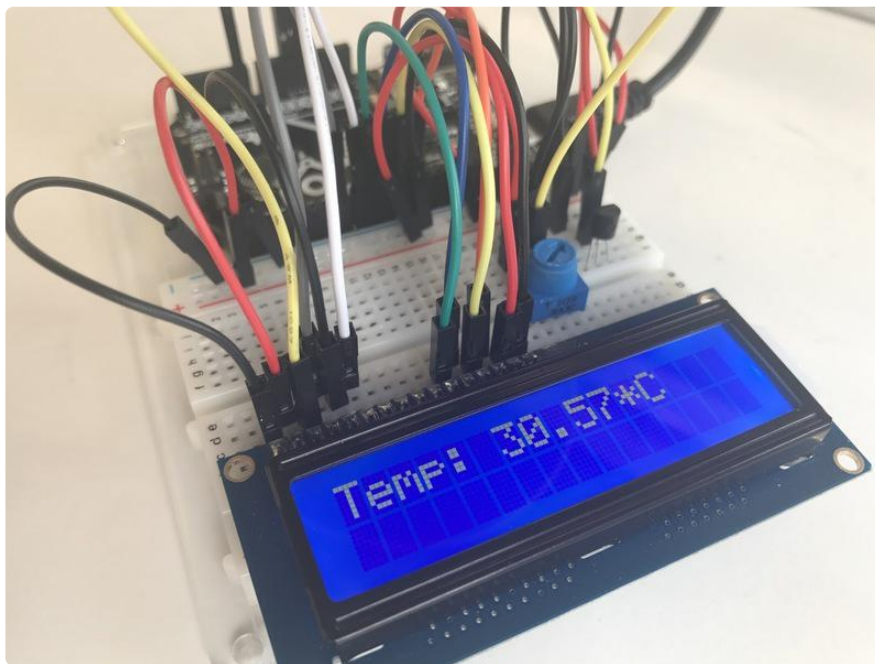

What if you want to show more output than a bunch of LEDs can handle? Sure, you could set up a bunch of LEDs to display numbers. But what if there was another way...

Character LCDs are super robust and great for output. Anything you can fit onto the 16 (lines) by 2 (rows) screen can be output by your code when you drop in the LiquidCrystal library, a collection of code that let's you add new functionality to your circuits.

We are going to re-create CIRC10. But instead of printing to a serial monitor, we are going to print to an external character LCD.

Parts



16x2 Character LCD

If you'd like to buy a white-on-blue 16x2 character lcd from the Adafruit shop, click [here!](#) ()

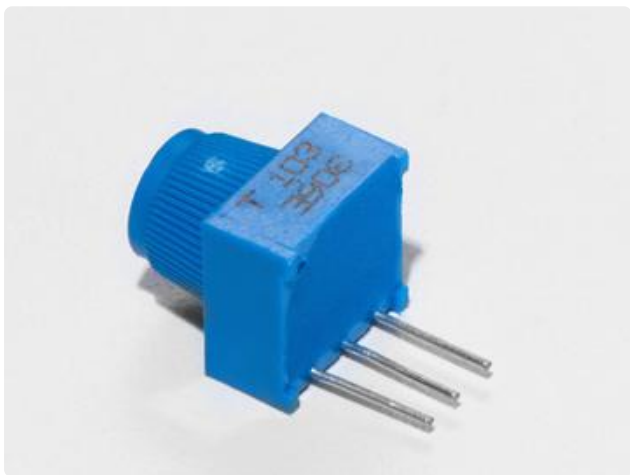

Breadboard Trim Potentiometer - 10k

If you'd like to buy an extra trimpot from the Adafruit store, click [here!](#) ()

This circuit uses the TMP36, NOT the NPN Transistor.

Am I using a TMP36 Temperature Sensor or a NPN Transistor ()

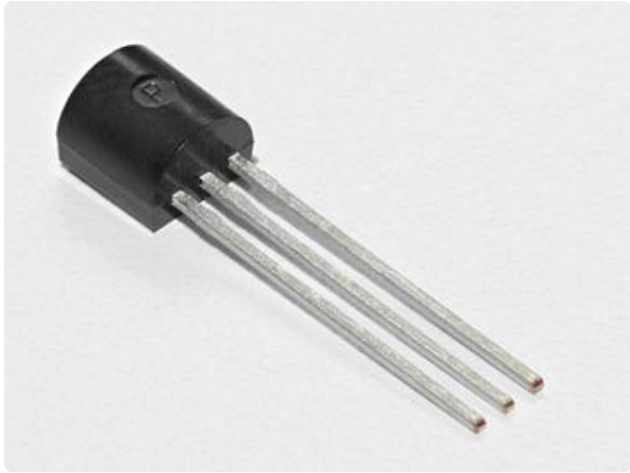

Analog Temperature Sensor

If you'd like an extra temperature sensor, you can grab one from the [Adafruit shop](#), click here ()

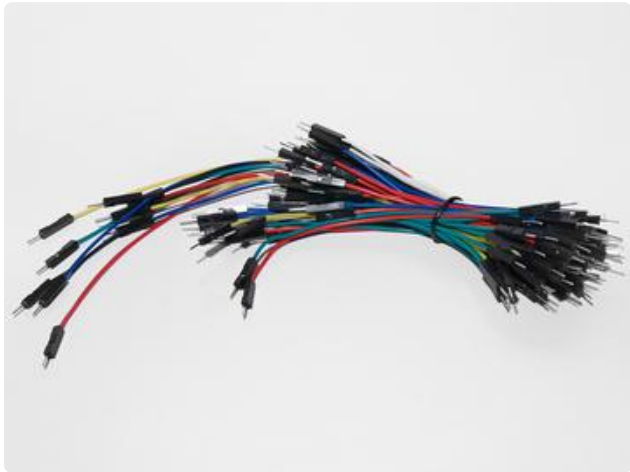

Breadboard Wiring Bundle

If you'd like to order more wires from the [Adafruit shop](#) click here! ()

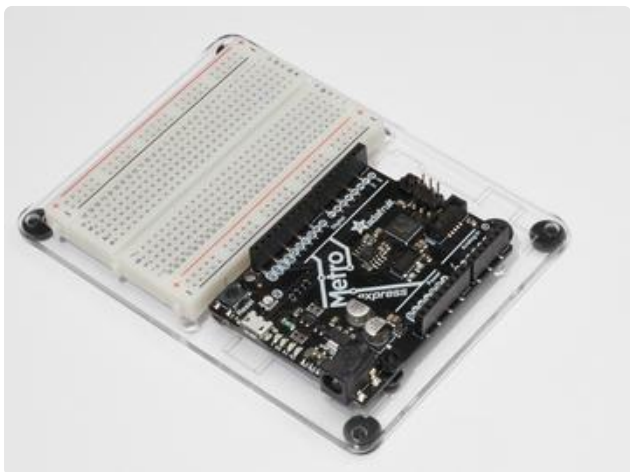

Adafruit Metro (or Metro Express) + Breadboard + Mounting Plate
If you have not assembled this, we have a [handy guide!](#) ()

If you'd like to order an extra plastic mounting plate (), [Adafruit Metro](#) (), [Adafruit Metro Express](#) (), or [Mini-Breadboard](#) () from the [Adafruit Shop](#) click here!

Wiring

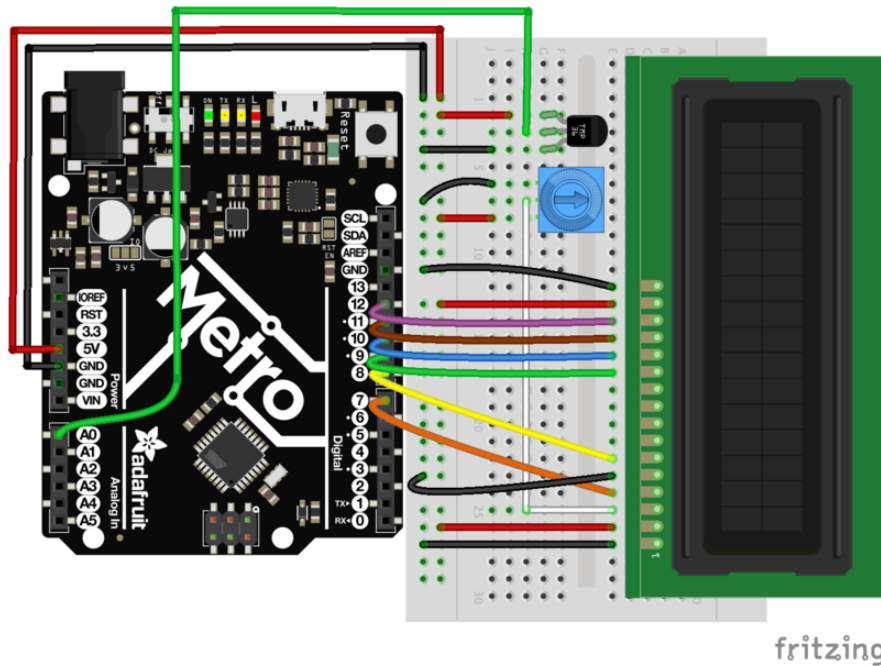

The wiring for the character LCD may be tricky. [There's a learn guide that walks through each individual wire.](#) () If you want to work along with it, be sure to place the LCD on the right side of the breadboard to ensure you can fit the potentiometer and the TMP36 sensor on the breadboard too.

Code

CIRC15 uses code that will work for both the Metro and the Metro Express. You'll need to make a tiny modification to it to get it working with the Metro you own. [\(If you're not sure what board you have, click here!\)](#) ().

If you're using a Metro EXPRESS, change `#define ANALOGREFVOLTAGE` to `#define ANALOGREFVOLTAGE 3.333`

Code:

```
/*
 * CIRC15: Digital Thermometer
 * Experimenter's Guide for Metro (and Metro Express!)
 * by Brent Rubell for Adafruit Industries ~ Support Open Source, buy adafruit!
 */

// If you're using a METRO EXPRESS, change this value to 3.333
#define ANALOGREFVOLTAGE 5.000
```

```

// include the lcd library code:
#include <LiquidCrystal.h>

// initialize the library with the numbers of the interface pins
LiquidCrystal lcd(7, 8, 9, 10, 11, 12);

// TMP36 Pin
int temperaturePin = 0;

void setup() {
  Serial.begin(9600);
  // set up the LCD's number of columns and rows:
  lcd.begin(16, 2);
}

void loop() {

  float temperature = 0;
  temperature = getVoltage(temperaturePin);

  /* Output: Degrees C */
  temperature = (temperature - .5) * 100;
  /* Output: Degrees F */
  // temperature = (((temperature - .5) * 100)*1.8) + 32;
  /* Output: Voltage */
  // temperature = (temperature - .5) * 100; d

  // Write temperature to the LCD
  lcd.print("Temp: ");
  lcd.setCursor(6,0);
  lcd.print(temperature);
  lcd.setCursor(11,0);
  lcd.print("*C");
  // Wait 1s
  delay(1000);
  // Refresh the LCD
  lcd.clear();
}

float getVoltage(int pin) {
  return(float(analogRead(pin))* float(ANALOGREFVOLTAGE/1023.000));
}

```

After uploading this code, make sure the backlight is lit up and twist the potentiometer until you can clearly see the text/numbers.

Having Trouble?

I don't see anything on the LCD

Try twisting the potentiometer. If that doesn't work, re-check your wiring.

Text on the LCD is strange characters or garbled

Make sure the pins of the LCD are flush with the breadboard. If that doesn't work, re-upload the sketch from Arduino.

The number on the LCD is not possible, it's too high/low

The included code has a line that uses the serial monitor. Pop open the serial monitor and check the number in there against what you think the current temperature is. If the number seems off, double check wiring to Analog Pin A0.

I'm still having trouble, I think the diagram is too complicated.

The character LCD has a lot of wires and it's hard to keep track. [We have a great guide that takes you step-by-step. Check it out! \(\)](#)

Make It Better

Using Fahrenheit

We are going to convert the degrees displayed by the example code to in Celsius to Fahrenheit. In `loop()`, change the following lines:

```
// Degrees C
//temperature = (temperature - .5) * 100;
// Degrees F
temperature = (((temperature - .5) * 100)*1.8) + 32;
```

Then, compile and upload the sketch to your metro and observe the number change.

Printing new text to the LCD

Did you notice that even though the number changed, the *C was still printed to your display? This is because the *C is hard-coded into the display.

To change *C to *F, change the following line:

```
lcd.print("*C"); -> lcd.print("*F");
```

Then, compile and upload to the Metro. Your temperature should display the Fahrenheit unit and temperature symbol.

Printing to the Second Row

The intro mentioned this LCD was 16x2. It has two rows you can print to, but we are only using one. Let's print the *F symbol to the same spot in the second row. To do this, modify the following code in your `loop()`:

```
lcd.setCursor(11,1); // instead of (11,0), we are printing to (11,1), the 2nd row
lcd.print("**F");
```

Using Custom Characters

The LiquidCrystal library contains a command called `createchar()` which can create a custom character (a glyph!) for printing to the LCD. Our code uses an asterisk instead of a degrees symbol. Let's complete the thermostat and have a real degrees symbol.

To do this, add the following code above your `setup()` loop:

```
// Custom Degree Symbol
byte degree[8] = {
  0x7,
  0x5,
  0x7,
  0x0,
  0x0,
  0x0,
  0x0,
  0x0,
};
```

In the `setup()` loop, add the following line:

```
lcd.createChar(0, degree);
```

Finally, in the `loop()`, modify the following lines:

```
lcd.setCursor(11,1);
lcd.write(byte(0)); // custom degrees character
lcd.setCursor(12,1);
lcd.print("F");
```

After compiling and uploading, you should see the degree symbol next to the F.

Making your own Custom Character

If you want to add more custom characters, or different ones, there's a great online generator we like. You can add in your own icons, for whatever you want. Let's learn how to do this:

First, [visit the HD44780 graphic generator site](#) (). Then, change the character size to 5 by 8

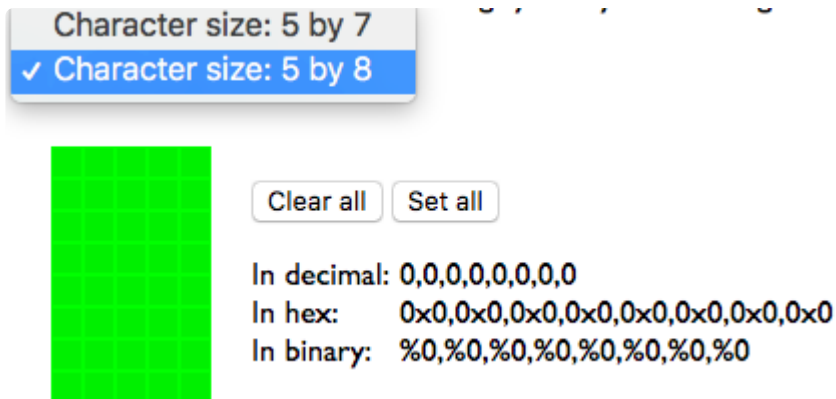

Click the boxes to set pixels. When a pixel is set, it'll turn from green to black. You can un-set pixels by clicking on a black pixel (on) to turn it green (off).

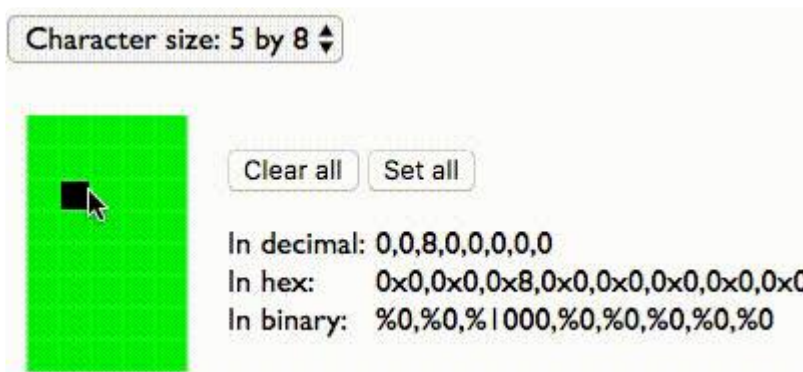

Once you have your custom character, copy the values from "In Hex" and paste them into an Arduino sketch as a byte array:

```
// smiley face  
byte smile[8] = {  
  0x0,  
  0x0,  
  0x8,  
  0x0,  
  0x0,  
  0x0,  
  0x0,  
};
```



In the `setup()` loop, add the following line:

```
lcd.createChar(0,smile);
```

Then, in `loop()` add the following to write your custom character to the LCD:

```
lcd.write(byte(0)); // custom degrees character
```

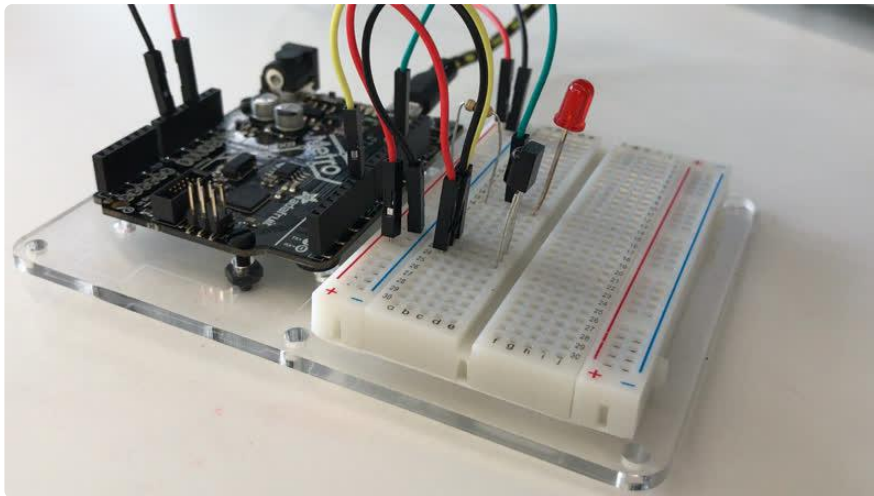
CIRC16: IR Sensor



IR Receiver Sensors are photocells tuned to receive IR frequencies. The IR frequency is not visible to the human eye, but can be picked up by a webcam or cell phone.



Try pressing a button on the [Mini Remote Control \(\)](#) or a TV/DVD-player remote and shining it at your webcam. The light you see emitted by the remote is Infrared light. These Infrared Signals are PWM signals carrying pulses (marks) and intervals (spaces) carrying 32 bits of data.

The Experimenters Guide uses IRLib, an easy-to-understand Arduino library that demystifies the infrared light receiver. In the code section, we will go over installing this library and use it with this circuit.

Parts

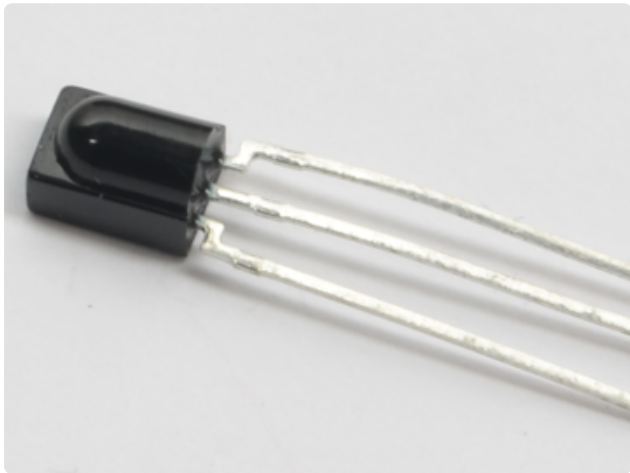

IR (Infrared) Receiver Sensor

If you'd like to order an extra IR receiver sensor from the Adafruit shop, [click here! \(\)](#)



Mini Remote Control

We suggest using this remote with CIRC15, but you can use any remote

If you'd like to order an extra Mini Remote Control from the Adafruit Shop, [click here! \(\)](#)



5mm Red LED

If you'd like to order more red LEDs (they make great indicator lights!) from the Adafruit shop, [click here!](#) ()



560 Ohm Resistor

Colors: Green > Blue > Brown

If you'd like to order more resistors from the Adafruit shop [click here!](#) (they are 470ohm but they'll be fine) ()



Breadboard Wiring Bundle

If you'd like to order more wires from the Adafruit shop [click here!](#) ()

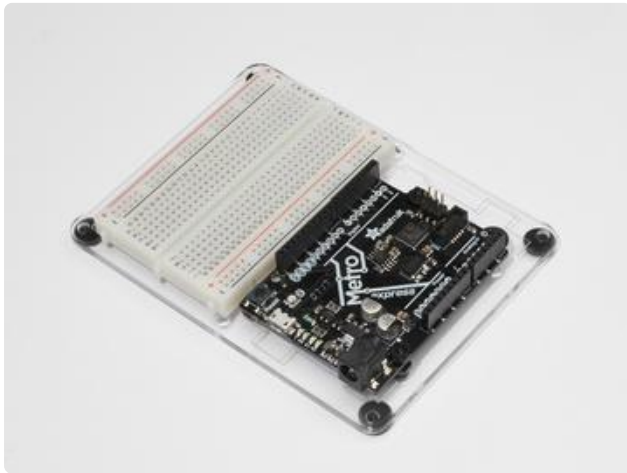

Adafruit Metro (or Metro Express) + Breadboard + Mounting Plate
If you have not assembled this, we have a [handy guide!](#) ()

If you'd like to order an extra plastic mounting plate (), Adafruit Metro (), Adafruit Metro Express (), or Mini-Breadboard () from the Adafruit Shop click [here!](#)

Wiring

Do NOT use any other digital pin except for Digital Pin 6 for the IR Sensor.

The wiring for this circuit is the same for the Metro and the Metro Express.

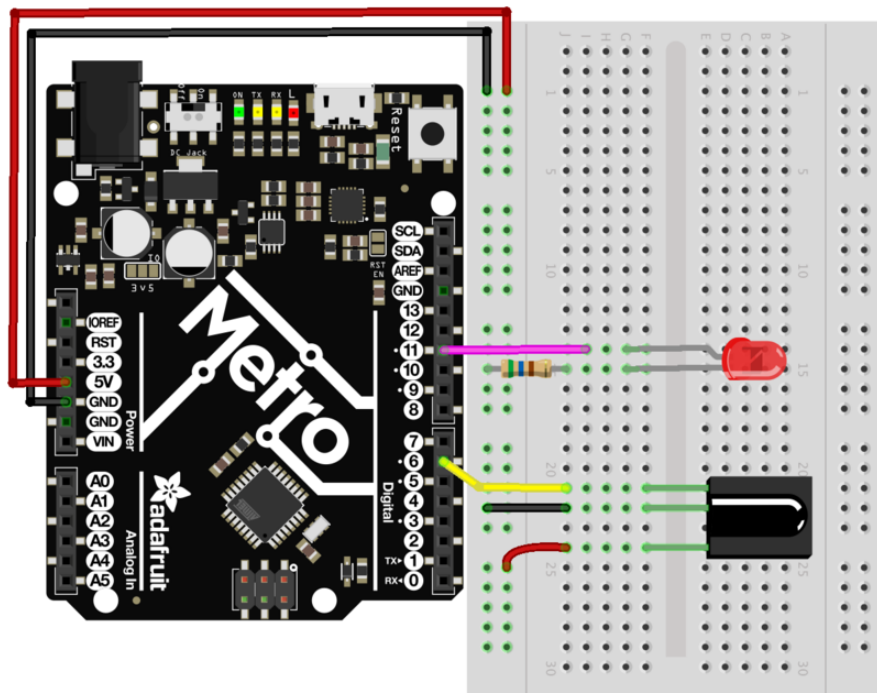

fritzing

Installing the IR Library

Installing Arduino Libraries

The Experimenters Guide uses [IRLib2 \(\)](#), an easy-to-understand Arduino library that de-mystifies the infrared light receiver. It makes writing code for IR Receiver and IR LED much easier.

Installing the IR Library

[Download the Latest Infrared Library](#)

To install the IR Library:

1. Download the IR Library by clicking the button above, or [download it directly from the IRLib 2.x Library from Github. \(\)](#)
2. Uncompress the ZIP file after it's finished downloading.
3. Check that the uncompressed folder contains five separate folders. IRLib 2.x contains multiple libraries that work together.
4. Copy all five into your Arduino Library folder root directory. The path will typically be in (home)/Documents/Arduino/Libraries. If you do not see the / Libraries/ folder, you may need to create this yourself.
5. Restart the Arduino IDE.

Code

Ensure you followed the Installing the IR Library Page. Copy and paste the code below into a blank Arduino Sketch. Then, compile and upload the code to your Metro.

Press button 1 and the LED should turn on. Any other button will turn the LED off.

```
/*
 * Metro Explorers Guide
 * CIRC16: IR Sensor
 *
 * Desc: Turns on and off a 5mm Red LED with Mini Remote (NEC)
 * by Brent Rubell for Adafruit Industries.  Support Open Source, buy Adafruit!
 *
 * Note: this sketch requires IRLIB2.x
 */
// include all IRLib 2.x libraries
#include <IRLibAll.h>

// These values are for the Adafruit Mini Remote (using the NEC Protocol)
```

```

#define MY_PROTOCOL NEC
// Handles NEC repeat codes
uint32_t Previous;
// button(s)
#define BUTTON_0 0xfd30cf
#define BUTTON_1 0xfd08f7
#define BUTTON_2 0xfd8877
#define BUTTON_3 0xfd48b7
#define BUTTON_4 0xfd28d7
#define BUTTON_5 0xda857
#define BUTTON_6 0xfd6897
#define BUTTON_7 0xfd18e7
#define BUTTON_8 0xfd9867
#define BUTTON_9 0xfd58a7

// pin for the reciever
IRrecv myReceiver(6);
// decoder class
IRdecode myDecoder;

// LED PIN
int ledPin = 11;

void setup() {
  // set the ledPin as an output
  pinMode(ledPin, OUTPUT);
  // enable the receiver
  myReceiver.enableIRIn();
}

void loop() {
  // if the receiver gets a signal
  if(myReceiver.getResults()) {
    // decode the signal
    myDecoder.decode();
    // set the decoder's protocol to the set protocol
    if(myDecoder.protocolNum == MY_PROTOCOL) {
      // if there
      if(myDecoder.value == 0xFFFFFFFF) {
        // keep the led set to the last button value
        myDecoder.value = Previous;
      }
      // based on myDecoder.value, switch between button codes
      switch(myDecoder.value) {
        // Turn on the LED
        case BUTTON_1:
          digitalWrite(ledPin, HIGH);
          break;
        // otherwise, turn off the LED
        default:
          digitalWrite(ledPin, LOW);
          break;
      }
      // keep the LED set to the last button value
      Previous = myDecoder.value;
    }
    // enable the IR receiver
    myReceiver.enableIRIn();
  }
}

```

Not Working?

I don't see the colors change

Is your RGB LED wired correctly? Are you using a different remote than the one included in the MetroX or MetroX Express Kit? If so, check out CIRC17 for examples of using different infrared sources.

Fatal error: IRLibAll.h: No such file or directory #include

The IRLib 2.x library was improperly installed. Go back a step and make sure you have it installed.

I still don't see anything

[A broken circuit is no fun, post up in the Adafruit Support Forums and we will get back to you as soon as we can. \(\)](#)

CIRC17: IR Replay

We are going to build an IR Replay circuit. This circuit uses both the IR LED and the IR Sensor (you used this in CIRC15) to construct a circuit that can record and play back infrared signals from any remote control.

A great (and really fun) application of this is the [Adafruit TV-B-Gone Kit, \(\)](#) a way to turn off those annoying televisions in bars, stores, or doctors offices.



The concept of replaying an infrared signal is also super useful in other areas. Some garage door openers open the garage when a specific IR signal is received. Do some exploring to find out which devices you own are operated by an infrared signal, and take control of them.

Another application would be building an assistive device, a device to assist someone not able to perform everyday actions. You can create a great assistive device by combining this circuit, and the FSR, to make a pedal/press operated remote control for anything operated by IR.

You can even combine this circuit and the relay used in CIRC11 to receive a signal from a nearby remote and control the relay to switch the power on a DC-powered appliance (like a fan or a lamp).

Parts

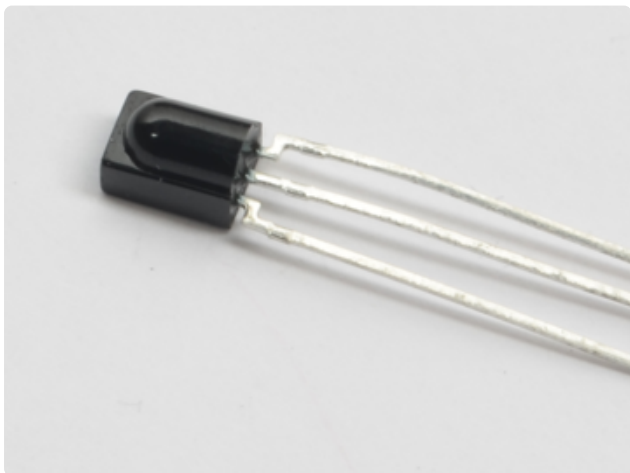

IR (Infrared) Receiver Sensor

If you'd like to order an extra IR receiver sensor from the Adafruit shop, [click here!](#) ()



Super-bright 5mm IR LED

If you'd like to order an extra 5mm IR LED from the Adafruit shop, [click here!](#) ()

This CIRC uses the NPN Transistor, not the TMP36.

Am I using a NPN Transistor or a TMP36 Temperature Sensor ()



Transistor (PN2222 or MPS2222)

If you'd like to order extra NPN transistors from the Adafruit shop, [click here!](#) ()



Pushbutton
Qty: x2

If you'd like to order more pushbuttons from the Adafruit shop, [click here!](#) ()



5mm Red LED

If you'd like to order more red LEDs (they make great indicator lights!) from the Adafruit shop, [click here!](#) ()



560 Ohm Resistor

Colors: Green > Blue > Brown

Qty: x2

If you'd like to order more resistors from the Adafruit shop click [here!](#) (they are 470ohm but they'll be fine) ()



10K Ohm Resistor

Colors: Brown > Black > Orange

Qty: x2

If you'd like to order more 10k ohm pull-up resistors from the Adafruit shop, click [here!](#) ()



Mini Remote Control (OPTIONAL)

You can use any remote for this circuit. We will use the Mini Remote for this example, though.

If you'd like to order an extra Mini Remote Control from the Adafruit Shop, click [here!](#) ()

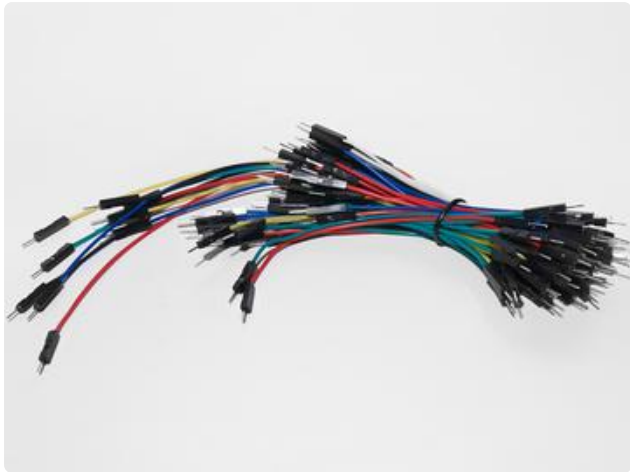

Breadboard Wiring Bundle

If you'd like to order more wires from the Adafruit shop click [here!](#) ()

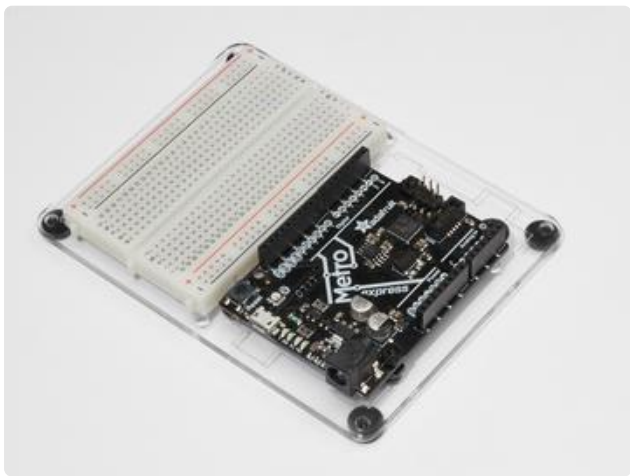

Adafruit Metro + Breadboard + Mounting Plate

If you have not assembled this, we have a [handy guide!](#) ()

If you'd like to order an extra plastic mounting plate (), Adafruit Metro (), or Mini-Breadboard () from the Adafruit Shop click [here!](#)

Wiring

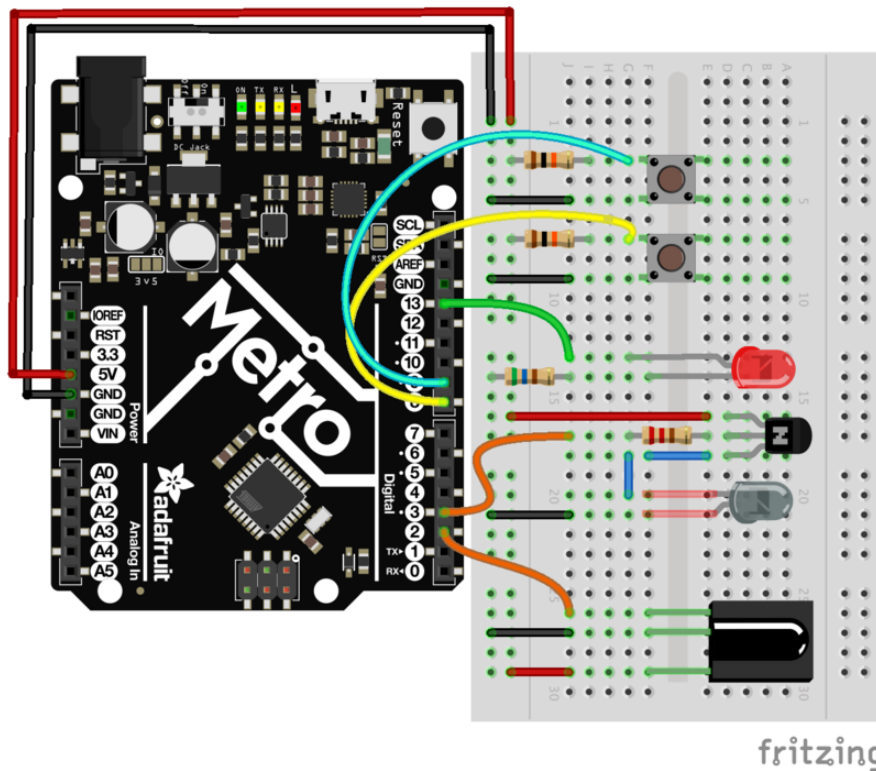

We spaced a lot of the components out such that they don't overlap on the breadboard. Be careful while wiring up the NPN transistor - it has a specific orientation which must be followed.

Code

[You'll need the IRLib2.x Library installed to use CIRC17. If you need to install it, click here! \(\)](#)

Copy and paste the code below into the Arduino Editor, then compile and upload it to your board.

```
/* CIRC17 - IR Replay
 * Requires: IRLib 2.x Library
 *
 * record.ino by Chris Young
 * modified by Brent Rubell for Adafruit Industries for the for the Metro (and
 Metro Express) Experimenters Guide. Support Open Source, buy Adafruit!
 */

/* IRLib */
#include <IRLibDecodeBase.h>; //We need both the coding and
#include <IRLibSendBase.h>; // sending base classes
#include <IRLib_P01_NEC.h>; //Lowest numbered protocol 1st
#include <IRLib_P02_Sony.h>; // Include only protocols you want
#include <IRLib_P03_RC5.h>;
```

```

#include <IRLib_P04_RC6.h>;
#include <IRLib_P05_Panasonic_Old.h>;
#include <IRLib_P07_NECx.h>;
#include <IRLib_HashRaw.h>; //We need this for IRsendRaw
#include <IRLibCombo.h>; // After all protocols, include this
// All of the above automatically creates a universal decoder
// class called "IRdecode" and a universal sender class "IRsend"
// containing only the protocols you want.
// Now declare instances of the decoder and the sender.
IRdecode myDecoder;
IRsend mySender;

// Include a receiver either this or IRLibRecvPCI or IRLibRecvLoop
#include <IRLibRecv.h>;
IRrecv myReceiver(2); //pin number for the receiver

// Storage for the recorded code
uint8_t codeProtocol; // The type of code
uint32_t codeValue; // The data bits if type is not raw
uint8_t codeBits; // The length of the code in bits

//These flags keep track of whether we received the first code
//and if we have have received a new different code from a previous one.
bool gotOne, gotNew;

/* Buttons */
// button -> pin number
const int playBtn = 8;
const int recBtn = 9;
// hold the button states
int playBtnState = 0;
int recBtnState = 0;

// status LED
const int ledPin = 13;

void setup() {
  gotOne=false; gotNew=false;
  codeProtocol=UNKNOWN;
  codeValue=0;
  /* BTNS AND LED */
  pinMode(ledPin, OUTPUT);
  digitalWrite(ledPin, LOW);
  pinMode(playBtn, INPUT);
  pinMode(recBtn, INPUT);

  Serial.begin(9600);
  Serial.println(F("Send a code from your remote and we will record it.));
  Serial.println(F("Type any character and press enter. We will send the recorded
code.));
  Serial.println(F("Type 'r' special repeat sequence.));
  myReceiver.enableIRIn(); // Start the receiver
}

// Stores the code for later playback
void storeCode(void) {
  gotNew=true; gotOne=true;
  codeProtocol = myDecoder.protocolNum;
  Serial.print(F("Received "));
  Serial.print(Pnames(codeProtocol));
  if (codeProtocol==UNKNOWN) {
    Serial.println(F(" saving raw data.));
    myDecoder.dumpResults();
    codeValue = myDecoder.value;
  }
  else {
    if (myDecoder.value == REPEAT_CODE) {
      // Don't record a NEC repeat value as that's useless.
      Serial.println(F("repeat; ignoring.));
    }
  }
}

```

```

    } else {
        codeValue = myDecoder.value;
        codeBits = myDecoder.bits;
    }
    Serial.print(F(" Value:0x"));
    Serial.println(codeValue, HEX);
}
}
void sendCode(void) {
    if( !gotNew ) { //We've already sent this so handle toggle bits
        if (codeProtocol == RC5) {
            codeValue ^= 0x0800;
        }
        else if (codeProtocol == RC6) {
            switch(codeBits) {
                case 20: codeValue ^= 0x10000; break;
                case 24: codeValue ^= 0x100000; break;
                case 28: codeValue ^= 0x1000000; break;
                case 32: codeValue ^= 0x8000; break;
            }
        }
    }
    gotNew=false;
    if(codeProtocol== UNKNOWN) {
        //The raw time values start in decodeBuffer[1] because
        //the [0] entry is the gap between frames. The address
        //is passed to the raw send routine.
        codeValue=(uint32_t)&(recvGlobal.decodeBuffer[1]);
        //This isn't really number of bits. It's the number of entries
        //in the buffer.
        codeBits=recvGlobal.decodeLength-1;
        Serial.println(F("Sent raw"));
    }
    mySender.send(codeProtocol,codeValue,codeBits);
    if(codeProtocol==UNKNOWN) return;
    Serial.print(F("Sent "));
    Serial.print(Pnames(codeProtocol));
    Serial.print(F(" Value:0x"));
    Serial.println(codeValue, HEX);
}
}

void loop() {

    recBtnState = digitalRead(recBtn);
    playBtnState = digitalRead(playBtn);

    if(recBtnState == HIGH ) {
        digitalWrite(ledPin, LOW);
        myDecoder.decode();
        // Re-enable receiver
        myReceiver.enableIRIn();
        digitalWrite(ledPin, HIGH);
    }

    if(playBtnState == HIGH) {
        // check for stored signal
        if(gotOne) {
            // send the IR Code
            sendCode();
            // re-enable receiver
            myReceiver.enableIRIn();
            digitalWrite(ledPin, LOW);
        }
    }
}
}

```

Not Working?

I don't see the LED lighting up

Try opening the Arduino Serial Monitor. There are `Serial.print()` statements in this code to help you debug.

I can receive but not send IR signals

Make sure your NPN Transistor is hooked up correctly, it is required for this circuit.

I'm really frustrated with this circuit, I don't see any output after debugging

This circuit is especially tricky because the Infrared Sensor and Receiver are kinda finicky, post up in the [Adafruit Support Forums](#) and we will get back to you as soon as we can. ()

Parts

This CIRCUIT only works with the Metro EXPRESS, not the Metro Classic

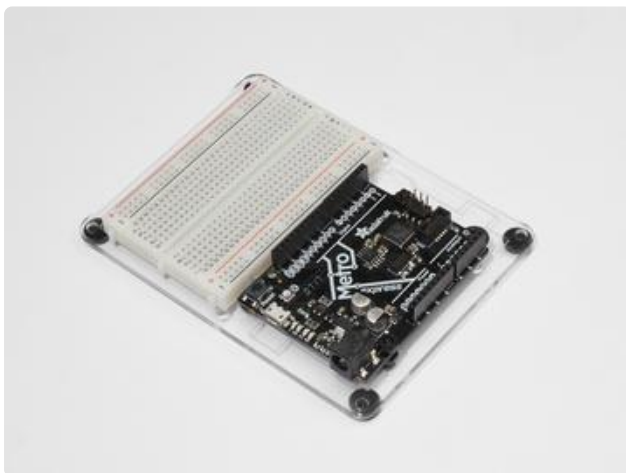

Adafruit Metro Express + Breadboard + Mounting Plate
If you have not assembled this, we have a [handy guide!](#) ()

Need an extra plastic mounting plate (),
[Adafruit Metro Express](#) (), or [Mini-Breadboard](#) () from the [Adafruit Shop](#)?

Wiring for Metro Express

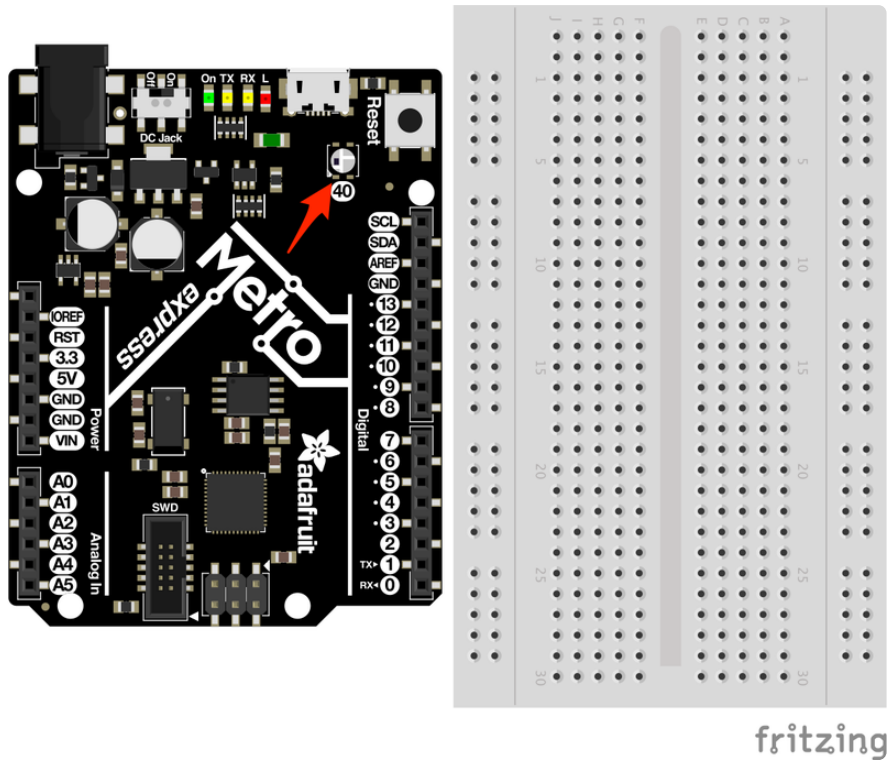

There's nothing to breadboard! The Metro Express has all the circuit required on the board (including the NeoPixel!). The NeoPixel is assigned to Digital Pin 40 on the Metro Express

Code

Installing the NeoPixel Library

Before copying and pasting the code, you'll need to install the NeoPixel Library. This is much easier than the installation of the IR Library - you can install the NeoPixel library directly from the IDE!

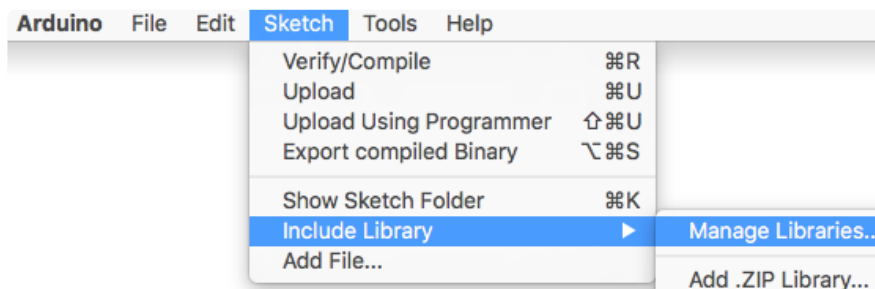

In Arduino, go to Sketch > Include Library > Manage Libraries.

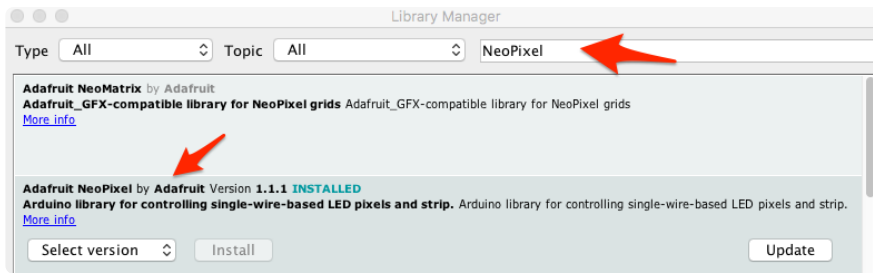

In the library manager, search for NeoPixel.

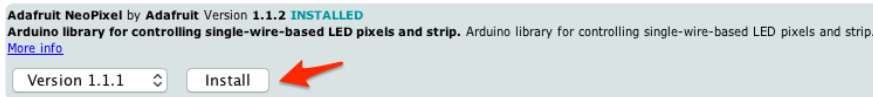

Then, find the latest version (1.1.1 at time of writing) and click install.

Once the status bar is finished, restart the Arduino IDE. The NeoPixel library has been installed.

Code

Copy/Paste the code below. Then, [compile and upload it to your metro \(\)](#).

You should see your Metro's NeoPixels light up red, white, and blue.

```

/*
 * (CIRC18) Metro Express NeoPixel
 * this circuit was designed for use with the Metro Explorers Guide on
 Learn.Adafruit.com
 *
 * note: this code does NOT run on the Metro, only the Metro EXPRESS.
 *
 * by Brent Rubell for Adafruit Industries.
 */

// Include the Adafruit Neopixel Library
#include <Adafruit_NeoPixel.h>

// The default pin for the NeoPixel on the Metro Express is Pin #40
#define METROPIXELPIN 40

// metroPixel takes in both the number of pixels (1, the built-in) and the pin)
Adafruit_NeoPixel metroPixel = Adafruit_NeoPixel(1, METROPIXELPIN);

/* Colors */
// note: the max. of colors in these arrays is 220 instead of 255 (super-bright!!)
const int RED[ ] = {155, 0, 0};
const int WHITE[ ] = {155, 155, 155};
const int BLUE[ ] = {0, 0, 255};
const int BLACK [ ] = {0, 0, 0};

void setup() {
  // init. the NeoPixel library
  metroPixel.begin();
}

```



```

void loop() {
  // display red on the Metro Express neopixel
  pixelWrite(RED);
  delay(1000);
  // display white on the Metro Express neopixel
  pixelWrite(WHITE);
  delay(1000);
  // display blue on the Metro Express neopixel
  pixelWrite(BLUE);
  delay(1000);

  // Sparkle the Neopixel
  // pixelSparkle();
}

// takes in a pre-defined color (integer array) and sets the pixel to that color
void pixelWrite(const int* color) {
  metroPixel.setPixelColor(0, metroPixel.Color(color[0],color[1],color[2]));
  // write the pixel color to the Metro's Neopixel
  metroPixel.show();
}

// flashes the neopixel on and off rapidly
void pixelSparkle() {
  for(int i = 0; i < 5; i++) {
    pixelWrite(BLACK);
    delay(50);
    pixelWrite(WHITE);
    delay(50);
  }
}

```

Having trouble?

My Code Wont Compile

Make sure that the NeoPixel library was correctly installed to the right location.

I don't see a NeoPixel on my board.

You must have a Metro, not a Metro Express. This circuit only works with the Metro Express.

I still don't see anything

[Post up in the Adafruit Support Forums](#) and we will get back to you as soon as we can. ()

Make It Better

Dimming the NeoPixel

Wow that NeoPixel sure is bright, huh? There is a really simple way to dim it. The NeoPixel takes a value from 0 to 255, 255 being the brightest.

Let's dim it by 100. In your code, change:

```
const int RED[ ] = {255, 0, 0}; to const int RED[ ] = {155, 0, 0};
```

Still too bright? Let's cut it by 1/3rd by changing:

```
const int GREEN[ ] = {128, 255, 0}; to const int GREEN[ ] = {128/3, 255/3, 0};
```

NeoPixel Glance Thermometer

We're going to modify the thermometer circuit to use the NeoPixel to assemble a color-coded thermometer. Glance over at this circuit and see the color which corresponds to a specific temperature.

Wiring

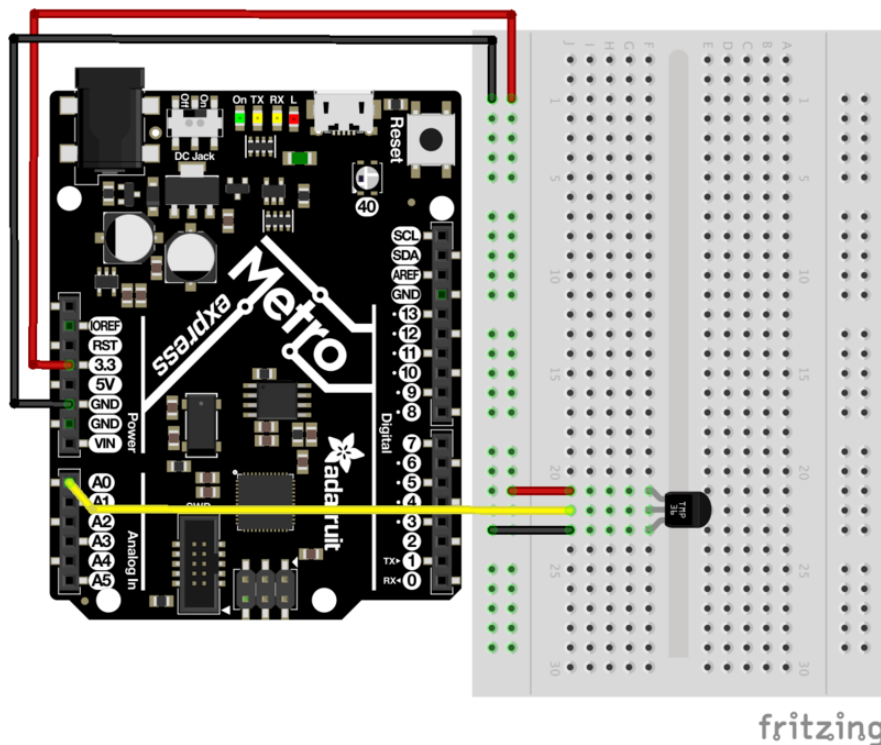

The wiring for this circuit is easy - just wire up the temperature sensor.

Code

Copy/paste the code below. Then, compile and upload it to your Metro Express!

```
/*
 * CIRC18 Make It Better
 * NeoPixel Glance Thermometer - check the weather super quickly!
 *
 * by Brent Rubell for Adafruit Industries
 */

// Include the Adafruit Neopixel Library
#include <Adafruit_NeoPixel.h>;

// The default pin for the NeoPixel on the Metro Express is Pin #40
#define METROPIXELPIN 40

// Temperature Sensor
const int temperaturePin = A0;

// metroPixel takes in both the number of pixels (1, the built-in) and the pin)
Adafruit_NeoPixel metroPixel = Adafruit_NeoPixel(1, METROPIXELPIN);
float temperature = 0;

/* Temperature Colors */
const int RED[ ] = {255, 0, 0};
const int ORANGE[ ] = {255, 153, 51};
const int YELLOW[ ] = {255, 255, 0};
const int LIGHTGREEN[ ] = {128, 255, 0};
```

```

const int DARKGREEN[ ] = {76, 153, 0};
const int DARKBLUE[ ] = {0, 0, 255};
const int DARKPURPLE[ ] = {51, 0, 102};
const int BLACK[ ] = {0, 0, 0};

void setup()
{
  // Start the Serial at 9600 baud
  Serial.begin(9600);
  // init the neopixel library
  metroPixel.begin();
}

void loop()
{
  temperature = getVoltage3V(temperaturePin);
  // Convert to degrees C
  temperature = (temperature - .5) * 100;
  // print the temperature in C to the
  serial
  Serial.println(temperature);
  // temp <-> color picker
  if (temperature > 40) {
    // red
    pixelWrite(RED);
  }
  else if (temperature > 35) {
    // orange
    pixelWrite(ORANGE);
  }
  else if (temperature > 30) {
    // yellow
    pixelWrite(YELLOW);
  }
  else if (temperature > 25) {
    // yellow
    pixelWrite(LIGHTGREEN);
  }
  else if (temperature > 20) {
    // dark green
    pixelWrite(DARKGREEN);
  }
  else if (temperature > 5) {
    // dark blue
    pixelWrite(DARKBLUE);
  }
  else {
    // dark purple
    pixelWrite(DARKPURPLE);
  }
  delay(1000);
}

// takes in a pre-defined color (integer array) and sets the pixel to that color
void pixelWrite(const int* color) {
  metroPixel.setPixelColor(0, metroPixel.Color(color[0],color[1],color[2]));
  // write the pixel color to the Metro's Neopixel
  metroPixel.show();
}

// Voltage to temperature if Vs= 3.3V
float getVoltage3V(int pin){
  // 3.3V/1023
  return (analogRead(pin) * 0.003225806452);
}

```

Adding the NeoPixel to CIRCs

The Glance Thermometer is a modification of the temperature circuit. Which CIRCs have you completed? How would you add a NeoPixel to the circuit to increase functionality, utility or aesthetic?

Parts

This CIRC only works with the Metro EXPRESS, not the Metro. Please confirm you are using a Metro Express before assembling this CIRC.

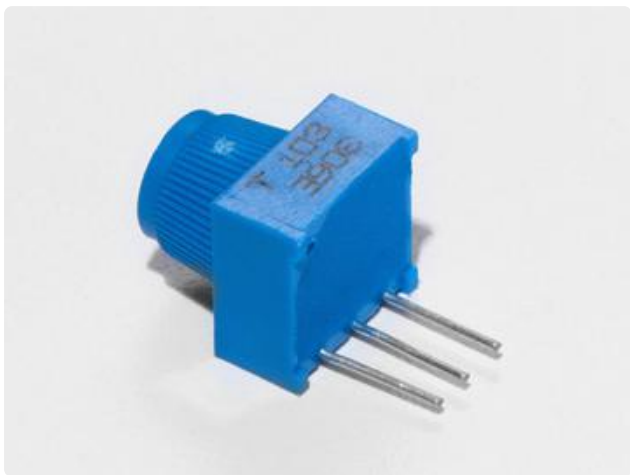

Breadboard Trim Potentiometer - 10k

If you'd like to buy an extra trimpot from the Adafruit store, [click here!](#) ()



Pushbutton

If you'd like to order more pushbuttons from the Adafruit shop, [click here!](#) ()



10K Ohm Resistor
Colors: Brown > Black > Orange

If you'd like to order more 10k ohm pull-up resistors from the Adafruit shop, click [here!](#) ()



Breadboard Wiring Bundle

If you'd like to order more wires from the Adafruit shop click [here!](#) ()

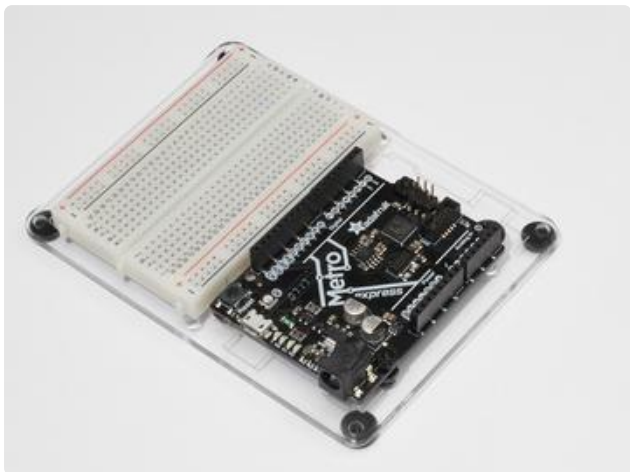

Adafruit Metro Express +
Breadboard + Mounting Plate
If you have not assembled this, we have a
[handy guide!](#) ()

Need an extra plastic mounting plate (),
[Adafruit Metro Express](#) (), or [Mini-Breadboard](#) () from the Adafruit Shop?

Wiring

This is a circuit on the Express line, it will only work with the Metro Express.

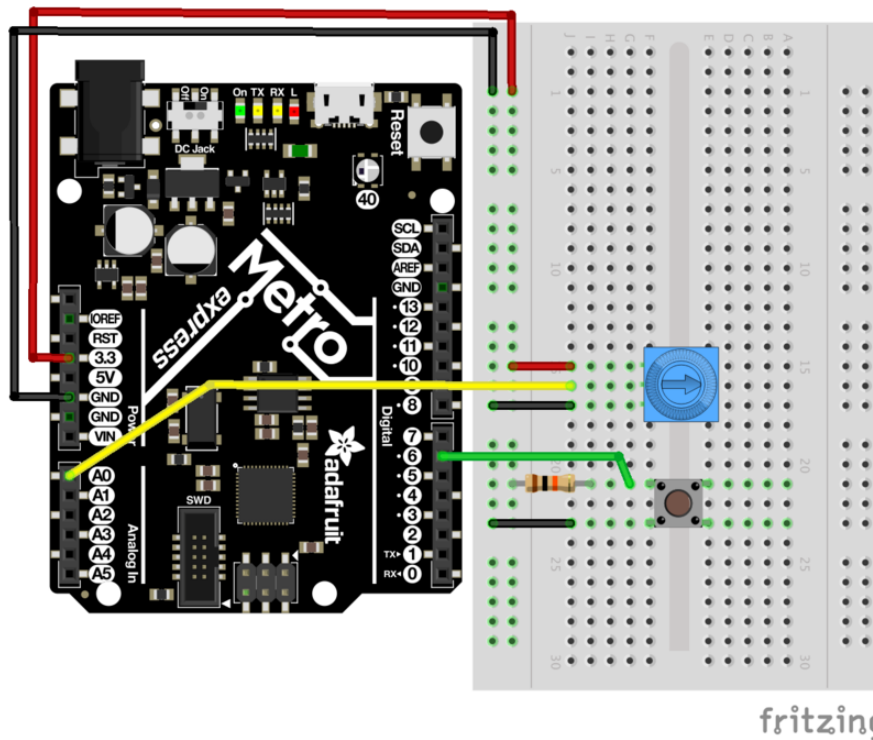

Code

The USB-HID Library is built into Arduino, there is no external installation required. Verify that you have a Metro Express, then copy and paste the code below into the Arduino Editor. Then, compile and upload.

```

/*
 * USB Blog Buddy
 * a USB-HID Scroll Wheel for Metro Express
 *
 * by Brent Rubell for Adafruit Industries.   Support Open Source, buy Adafruit!
 */

// include the mouse library
#include <Mouse.h>

// trimpot pin
const int trimPin = A0;

// button pin
const int buttonPin = 2;

// reduces scrolling speed (ms)
const int scrollDelay = 100;

// trimpot value
int trimValue = 0;

// button state
int buttonState = 0;

void setup() {
  // start serial monitor at 9600 baud
  Serial.begin(9600);
  // start the mouse

```

```
    Mouse.begin();
}

void loop() {
    // read the button state
    buttonState = digitalRead(buttonPin);

    if (buttonState == HIGH) {
        // stop the mouse if button not pressed
        Mouse.end();
    }
    else {
        // start the mouse (if stopped)
        Mouse.begin();
        // read the trimpot value
        trimValue = analogRead(trimPin);
        // map the trimValues to scroll wheel down (-neg values) and up (+pos values)
        trimValue = map(trimValue, 0, 1023, -5, 5);
        // move the mouse wheel (dont change cursor position)
        Mouse.move(0, 0, trimValue);
        // reduce the scrolling speed
        delay(scrollDelay);
    }
}
```

Using USB Blog Buddy

[Head over to the Adafruit Blog to test your circuit out! \(\)](#)

When you press the push button, the Metro Express will take control of your mouse and start scrolling the mouse wheel.

Scroll Page Up: Move the potentiometer such that the arrow on it faces towards the top of the breadboard

Scroll Page Down: Move the potentiometer such that the arrow on it faces towards the bottom of the breadboard

Not Working?

I don't see anything moving on my screen

Check your wiring, the library for USB interfacing is built into Arduino and should automatically start when you upload this code.

Still not working?

Post up in the [Adafruit Support Forums](#) and we will get back to you as soon as we can. ()

Parts

If you're using a Metro Classic:

You'll need a 1M Ohm Resistor.

If you're using a Metro M0 Express:

You're dont need any new parts, the M0 Express the capacitive sensor stuff managed completely inside the chip!

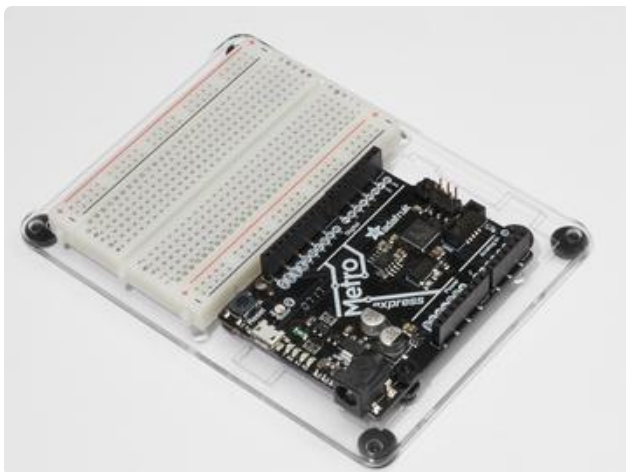

Adafruit Metro (or Metro Express) + Breadboard + Mounting Plate
If you have not assembled this, we have a [handy guide!](#) ()

If you'd like to order an extra plastic mounting plate (), [Adafruit Metro](#) (), [Adafruit Metro Express](#) (), or [Mini-Breadboard](#) () from the [Adafruit Shop](#) click [here!](#)

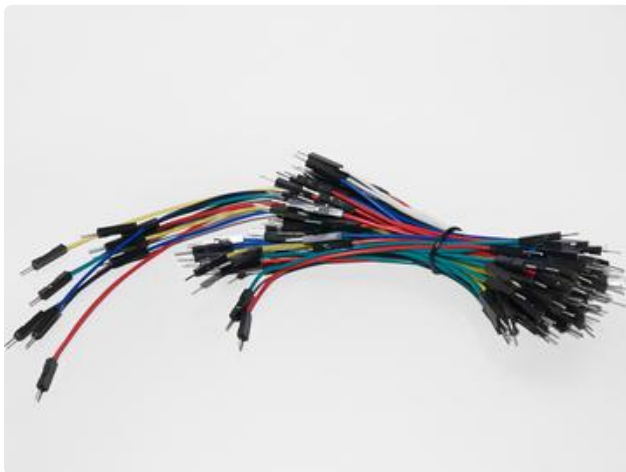

Breadboard Wiring Bundle

If you'd like to order more wires from the [Adafruit shop](#) click [here!](#) ()

Wiring

Wiring for the Metro Classic

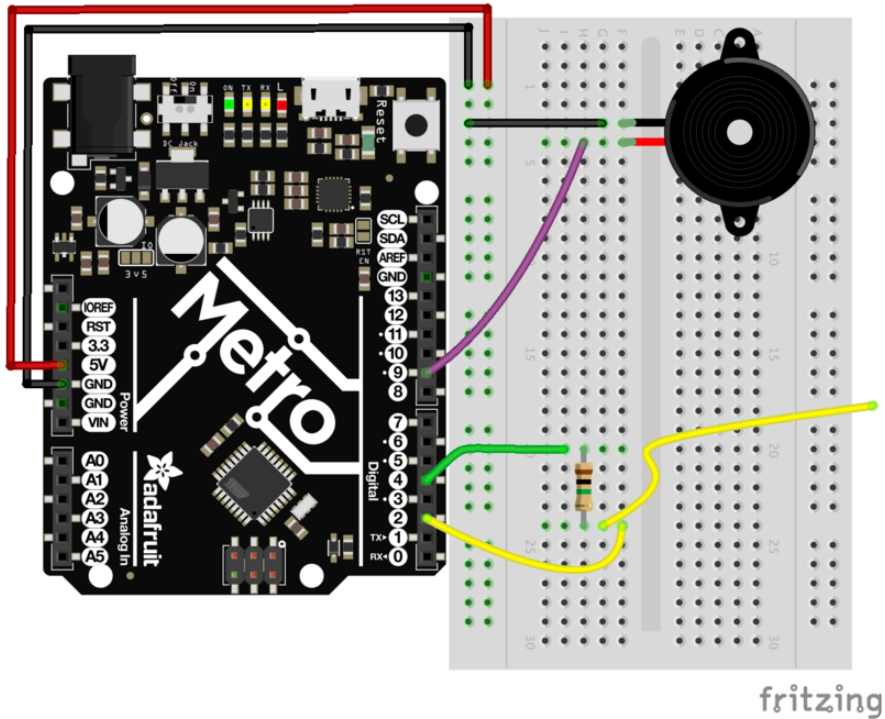

Pay attention to the resistor value!

You'll want to be using a 1M Ohm Resistor for this Circuit. The pin extending from the sensor pin (in our case, it's Digital Pin 2), should ideally be a short pin from the Breadboarding Bundle.

1M Ohm Resistor Color Band: Brown > Black > Green > Silver

Wiring for the Metro Express

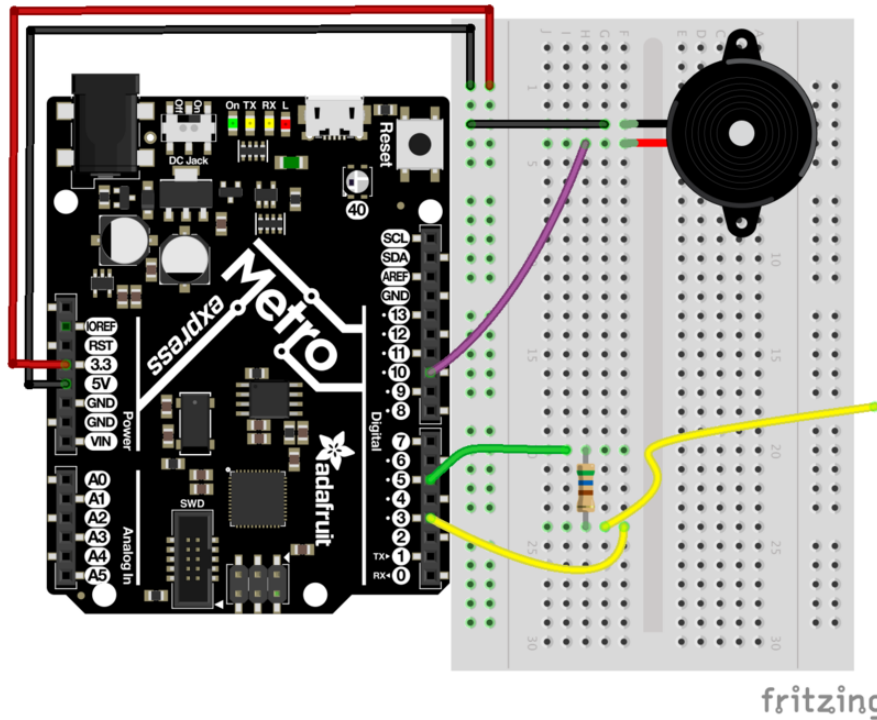

You don't need a 1M Ohm resistor for this circuit, just a smaller value (like the 560 ohm included in the MetroX Classic and MetroX Express kits). The Metro Express has 1M Ohm pull-up resistor values on-board.

Wiring for Metro Express

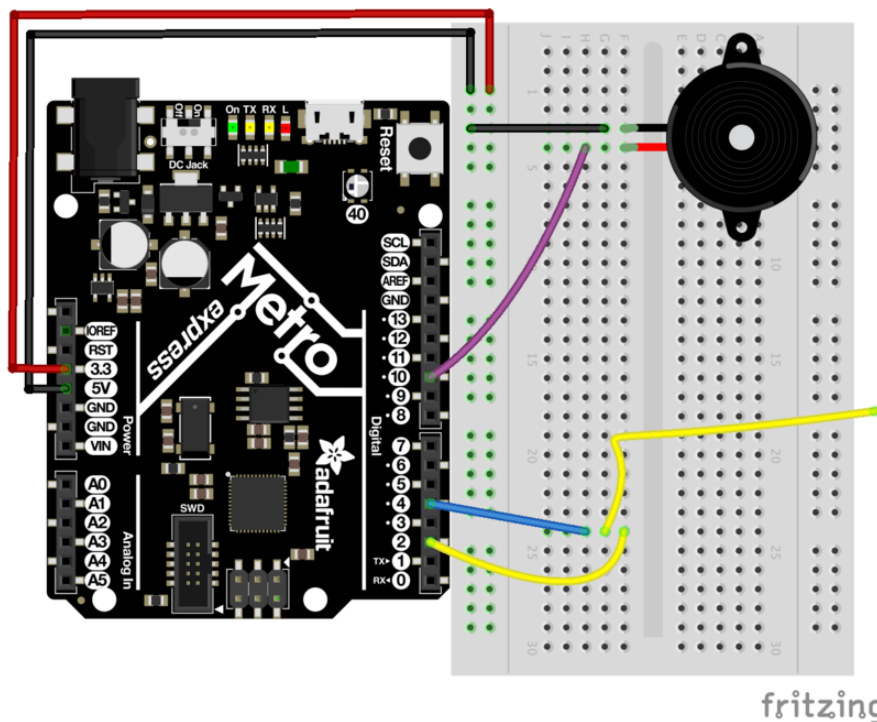

Code

You'll need to download install the CapacitiveSensor Library.

Open up the Arduino library manager:

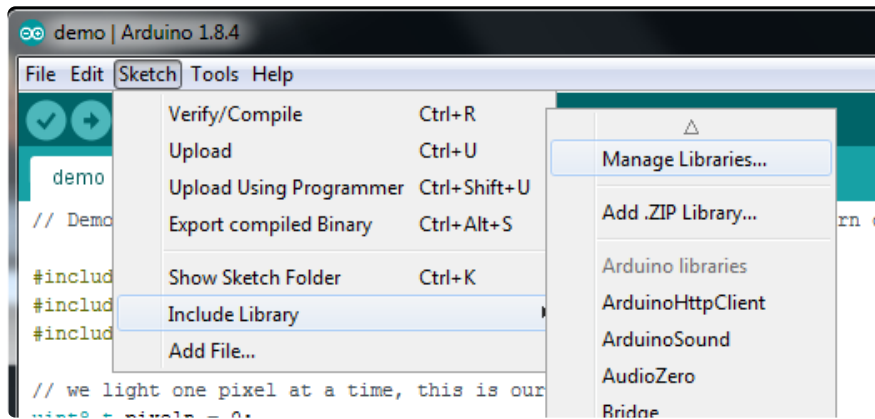

Search for capacitivesensor and install it

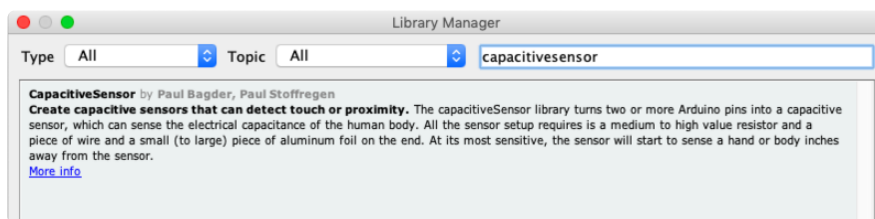

Code

After downloading and installing the CapacitiveSensor Library, copy and paste the code below into the Arduino IDE. Then, compile and upload it to your Metro (or Metro Express).

```
/*
 * CIRC20 - Capacitive Sensing with the Metro and Metro M0 Express
 *
 * by Brent Rubell for Adafruit Industries.   Support Open Source Hardware, Buy
Adafruit!
 */
#include <CapacitiveSensor.h>;

// piezo speaker pin
int piezoPin = 9;

// 10M resistor between pins 4 & 2, pin 2 is sensor pin, add a wire and or foil
if desired
// put a 10M resistor between pins 4 & 2, pin 2 is the sensor pin, 4 is the
receiver
CapacitiveSensor  cs_4_2 = CapacitiveSensor(4,2);
```

```

void setup()
{
  cs_4_2.set_CS_Autocal_Millis(0xFFFFFFFF);
  Serial.begin(9600);
  // set the piezo as an output
  pinMode(piezoPin, OUTPUT);
}

void loop()
{
  long start = millis();
  long pinTone = cs_4_2.capacitiveSensor(30);

  Serial.print("sensor value: ");          // check on performance in milliseconds
  Serial.print("\t");                      // tab character for debug windowdown
spacing
  Serial.print(pinTone);                   // print sensor output 1
  Serial.print("\n");

  // map the tone value to frequencies between 500 and 2000
  long mapTone = map(pinTone, 0, 40, 500, 2000);
  // play the mapped tone
  playTone(int(mapTone), 100);
  delay(10);
}

void playTone(int tone, int duration) {
  for (long i = 0; i < duration * 1000L; i += tone * 2) {
    digitalWrite(piezoPin, HIGH);
    delayMicroseconds(tone);
    digitalWrite(piezoPin, LOW);
    delayMicroseconds(tone);
  }
}

```

I'm having problems with this CIRC

Not hearing anything?

Open up the Arduino Serial Monitor. What do you see as the largest **sensor value** when you press the pin? The smallest? In the lien below, replace the values for **MIN_SENSOR_VALUE** and **MAX_SENSOR_VALUE** with the two numeric values you found:

```

long mapTone = map(pinTone, MIN_SENSOR_VALUE, MAX_SENSOR_VALUE,
500, 2000);

```

Getting sensor readings of 0?

When you open the Arduino Serial Monitor, do you see values of 0 or -2? The resistor you're using might be too small. We advise using a 1M Ohm resistor, not the 10K Ohm Resistor. That's one million ohms. If you don't have any 1M Ohm resistors, you can use any other similar (really large) resistor.

This isn't working at all.

[Post up in the Adafruit Support Forums](#) and we will get back to you as soon as we can. ()

Make It Better

Using Different Input Types

You can use many different types of inputs for the capacitive sensor. Among these are everything from Apples, salt water, and utensils (depending on the material). You can also use some of the different conductive materials from the Adafruit shop like [Conductive Rubber, \(\)](#) [Woven Conductive fabric \(try using this for wearable projects\) \(\)](#), or even [conductive paint pens to turn any material into a conductive one \(\)](#).

Adding Sensor Inputs

Need more inputs? You can continue using Digital Pin 4 for your receiver pin and any other digital pin can be used to create a capacitive sensor.

To do this, just add a line in your code:

```
CapacitiveSensor cs_4_# = CapacitiveSensor(4,#);
```

You'll need to replace `#` with the Digital Pin Number you want used as a sensor.

We're using Digital Pin 4 as the Receiver and Digital Pin 8 as the new sensor, so here's is how your breadboard should look:

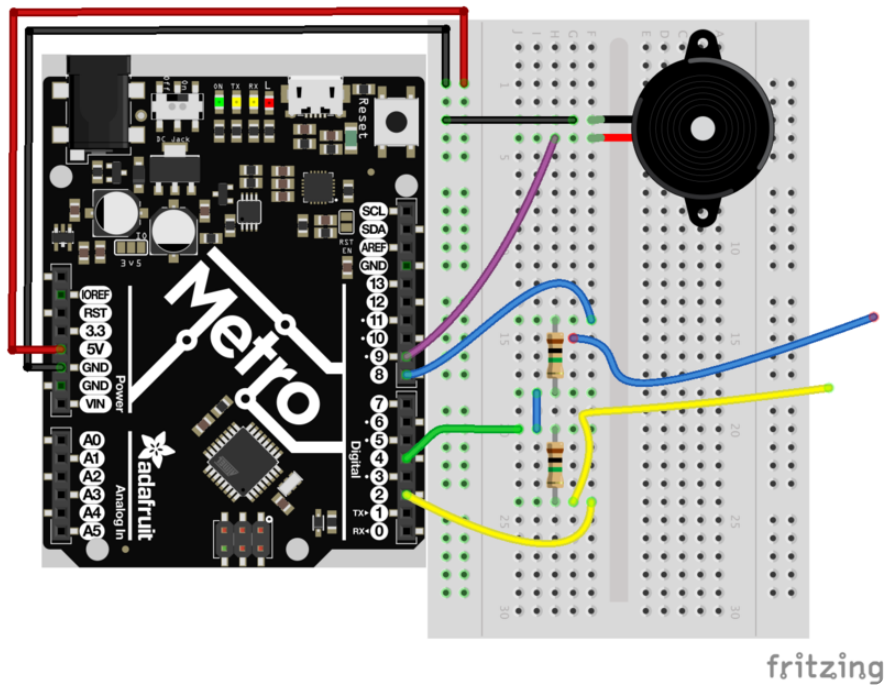

PROJ01: Theremin

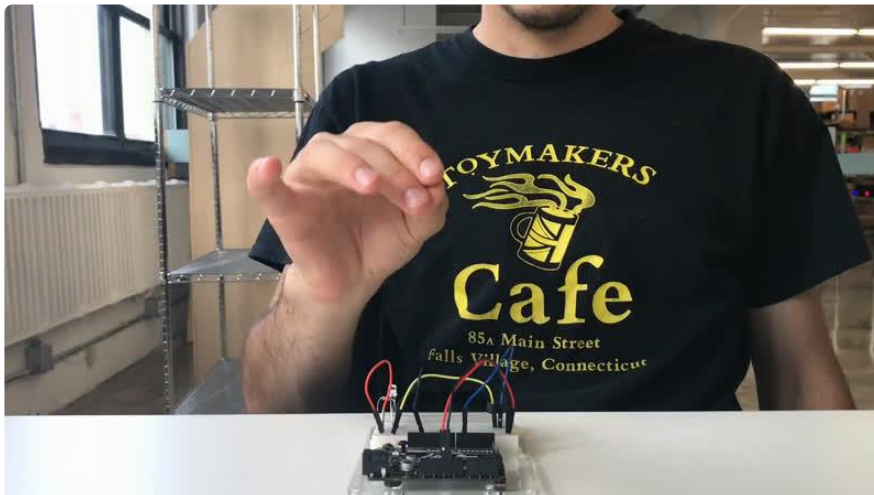

You are going to become a Thereminist! One of the stranger instruments out there is a [Theremin \(\)](#), an electronic instrument where you can wave your hands and make music! You are going to make one of your own, using your knowledge from previous CIRCs to guide you.

Parts



Photo Sensor

If you'd like to order another photoresistor from the Adafruit shop, [click here!](#) ()



Piezo Buzzer

If you'd like to order another Piezo Buzzer from the Adafruit shop, [click here!](#) ()



560 Ohm Resistor

Colors: Green > Blue > Brown

If you'd like to order more resistors from the Adafruit shop [click here!](#) (they are 470ohm but they'll be fine) ()

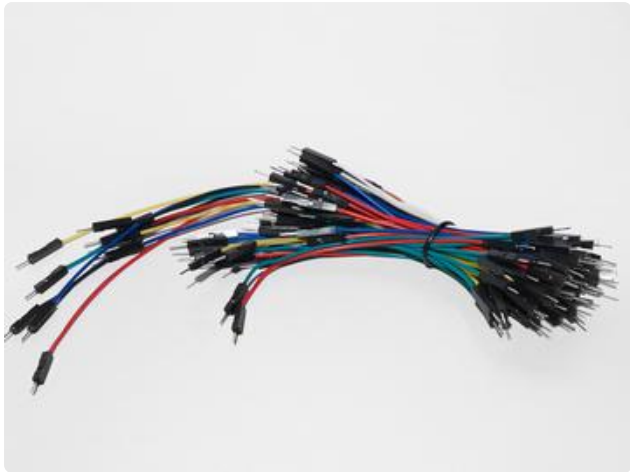

Breadboard Wiring Bundle

If you'd like to order more wires from the Adafruit shop click [here!](#) ()

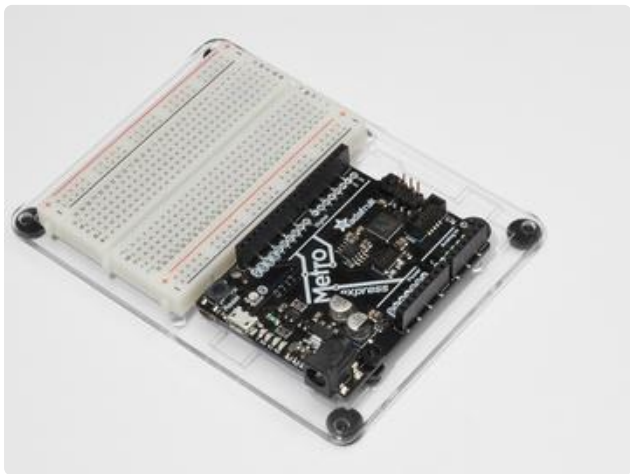

Adafruit Metro (or Metro Express) + Breadboard + Mounting Plate

If you have not assembled this, we have a [handy guide!](#) ()

If you'd like to order an extra plastic mounting plate (), Adafruit Metro (), Adafruit Metro Express (), or [Mini-Breadboard](#) () from the Adafruit Shop click [here!](#)

Wiring

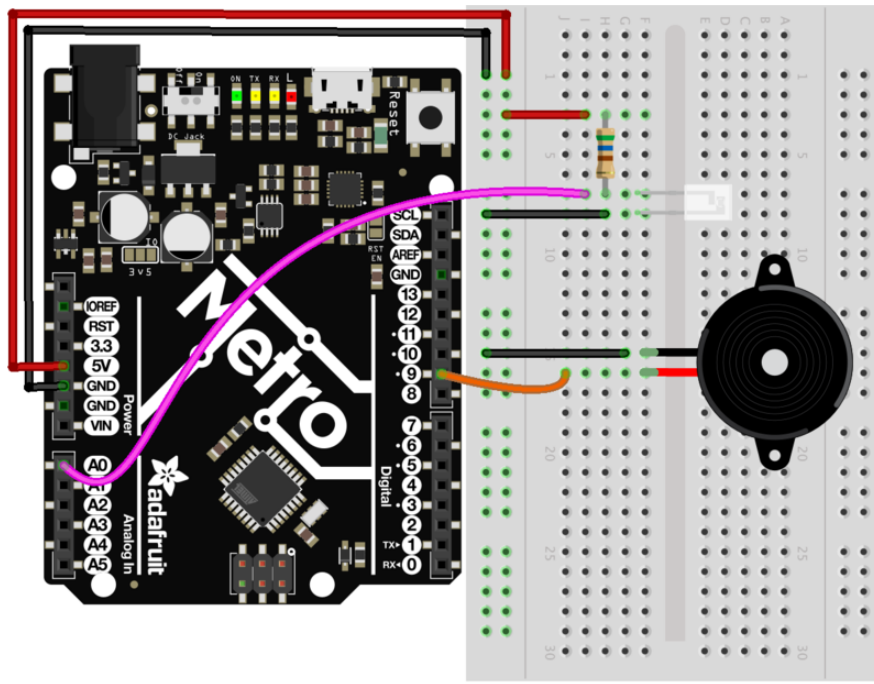

fritzing

Wiring for Metro Express

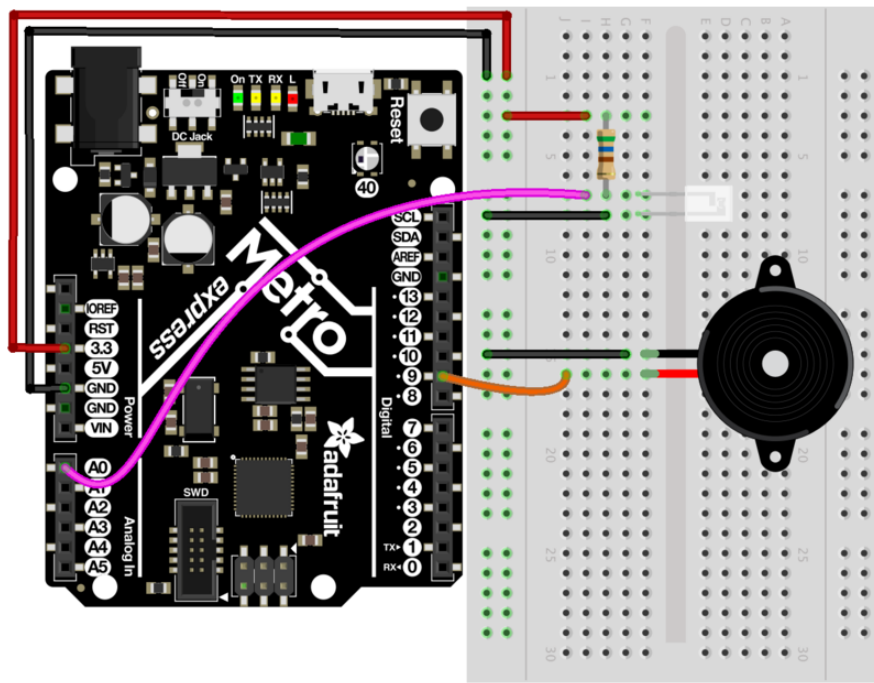

fritzing

Code

Setting Pins

```
int piezoPin = 9;
int photoLightSensorPin = A0;
```

The pins for both the piezo and the photo light sensor are both declared as integer types. The A in front of the photo light sensor stands for analog.

Reading the photo light sensor

```
void loop() {
  // get photo sensor value
  int photoVal = analogRead(photoLightSensorPin);
}
```

The photo light sensor is read within the `loop()`. We restricted the `photoVal` to integer values only (no decimal points). Then, an `analogRead()` was called on the photo light sensor pin to read pin data.

Creating the Pitch

```
int pitch = map(photoVal, 190, 1100, 150, 1500);
```

The pitch variable is created to store the resulting pitch. Then, `map()` is called. This function takes in `photoVal` and `photoVal`'s lower and upper values. Then, it maps that range to a range within 150Hz and 1500Hz

Playing the Pitch

```
// play tone
tone(piezoPin, pitch);
```

`Tone()` is passed both the pin with the Piezo and the pitch integer generated before.

The complete theremin code is below. Copy and paste it into a blank Arduino sketch, then compile and upload!

```
/*
 * (PROJ01) Metro (and Metro Express) Theremin
 * Desc: Super basic theremin using a light sensor and a piezo element
 *
 * by Brent Rubell for Adafruit Industries.
 */

int piezoPin = 9;
int photoLightSensorPin = A0;

void setup() {
  Serial.begin(9600);
}

void loop() {
  // get photo sensor value
  int photoVal = analogRead(photoLightSensorPin);
  /* Create the pitch
   * map() the photolightsensor value to
   * a frequency from 150Hz to 1500Hz
   * more info about map() - https://www.arduino.cc/en/Reference/Map
   */
  int pitch = map(photoVal, 190, 1100, 150, 1500);
  // play tone
  tone(piezoPin, pitch);
}
```

Move your hand around the circuit to play music with your theremin! Congrats, you just built your first quest circuit.

Bored of this theremin? Let's Make It Better!

Wait...my PROJect doesn't work!

I don't hear anything

Check the wiring of both the piezo and the light sensor. You might find flipping the light sensor around will fix it.

I can't get this working at all

We'll help you out! [Post up in the Adafruit Support Forums](#) and we will get back to you as soon as we can. ()

Make It Better

Modifying the pitch

Taking a look at how `map()` works in the Theremin quest circuit, you can start to understand how map works:

```
map(value, fromLow, fromHigh, toLow, toHigh); to map(photoVal, 190, 1100, 150, 1500);
```

The first two values correspond to the photo light sensor, while the last two are the pitch. Try modifying the last two values (150 and 1500) up and down. You'll get different sounds every time!

Stop the Music!

You may have gotten annoyed with the spooky sounds coming out of your theremin. There are two ways to stop this sound.

One way to do this is with a push-button. Plug one into your breadboard and wire it up to Digital Pin 2:

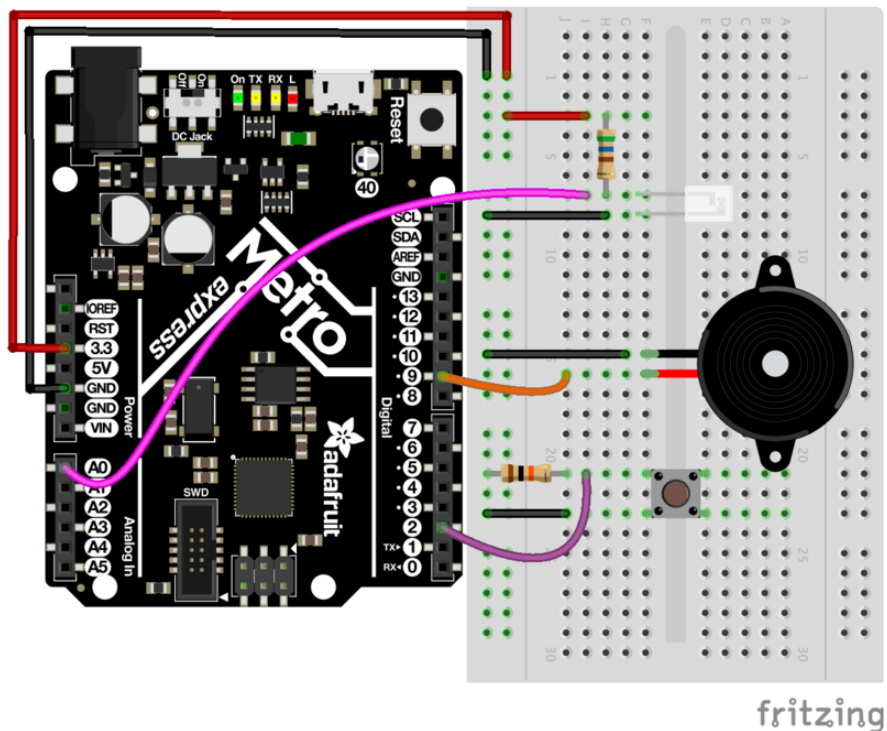

fritzing

Next, modify the Arduino code to call `NoTone()` when the button is pressed. We'll leave this up to you to figure out. One hint is to look at both the [NoTone\(\) documentation](#) () and CIRC07's code.

PROJ02: MetroPOV Display

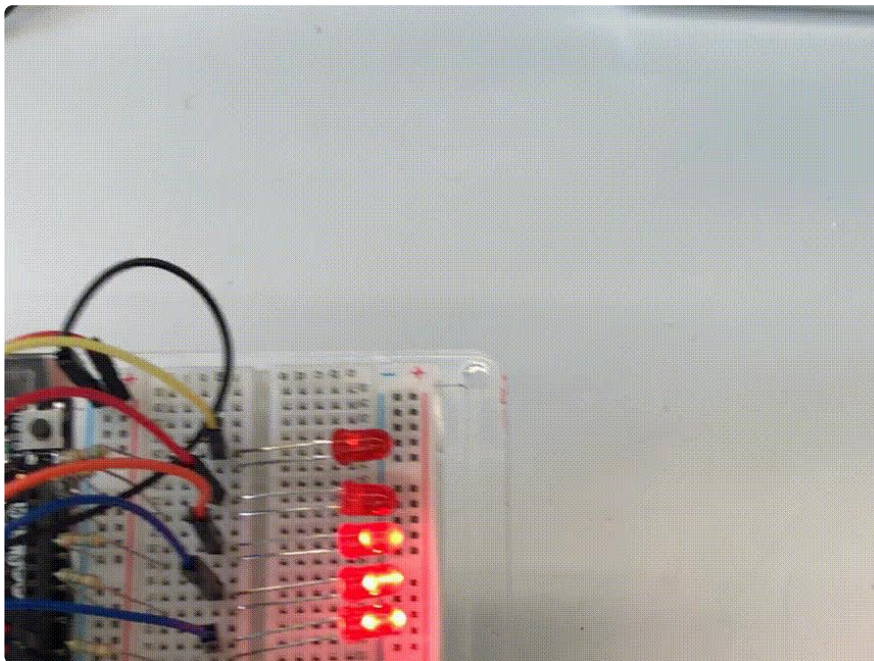

Persistence of vision refers to the optical illusion that occurs when visual perception of an object does not cease for some time after the rays of light proceeding from it have ceased to enter the eye ([more about persistence of vision here](#) ()).

One of the cool kits made by Adafruit is the [MiniPOV 4](#) (), a DIY Full-Color POV Display. The MiniPOV creates this illusion and allows you to paint with light in mid-air. In this quest, you are going to create the MetroPOV, a circuit that uses Persistence of Vision and the Adafruit Metro. You'll learn about persistence-of-vision, optical illusions, and create your own drawings.

Let's paint the sky with the Metro!

Parts



5mm Red LED

If you'd like to order more red LEDs (they make great indicator lights!) from the Adafruit shop, [click here!](#) ()



560 Ohm Resistor

Colors: Green > Blue > Brown

If you'd like to order more resistors from the Adafruit shop [click here!](#) (they are 470ohm but they'll be fine) ()



Breadboard Wiring Bundle

If you'd like to order more wires from the Adafruit shop [click here!](#) ()

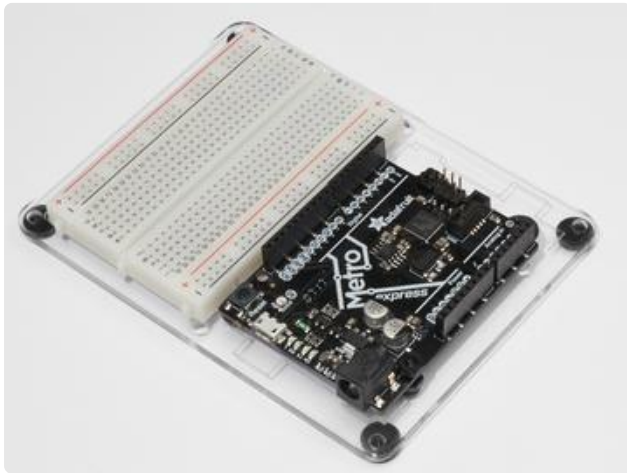

Adafruit Metro (or Metro Express) + Breadboard + Mounting Plate
If you have not assembled this, we have a handy guide! ()

If you'd like to order an extra plastic mounting plate (), Adafruit Metro (), Adafruit Metro Express (), or Mini-Breadboard () from the Adafruit Shop click here!

Wiring

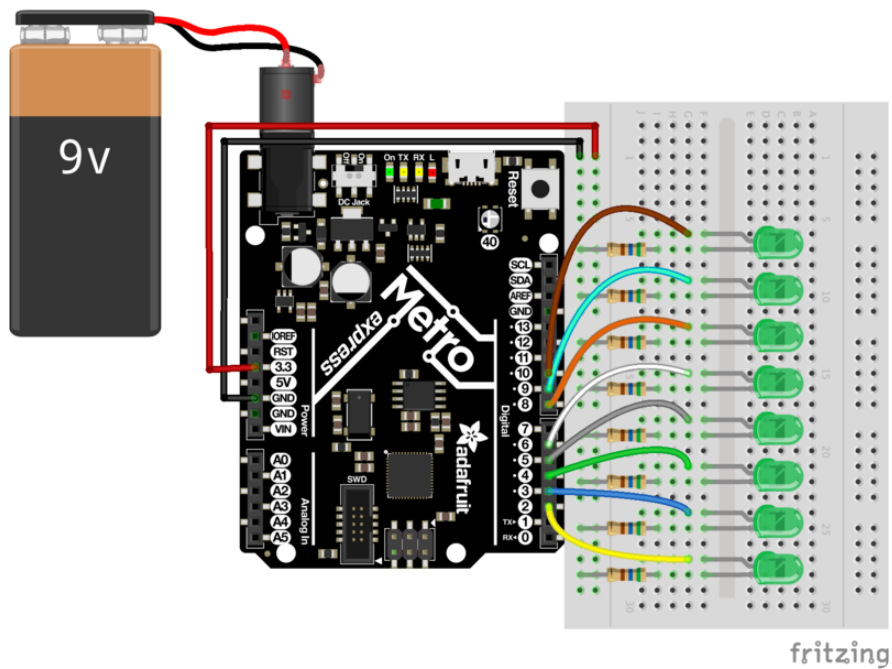

The breadboard circuitry is similar to CIRC02's layout. We suggest either using the Red 5mm LEDs or Green 5mm LEDs. Pick your favorite color and use that!

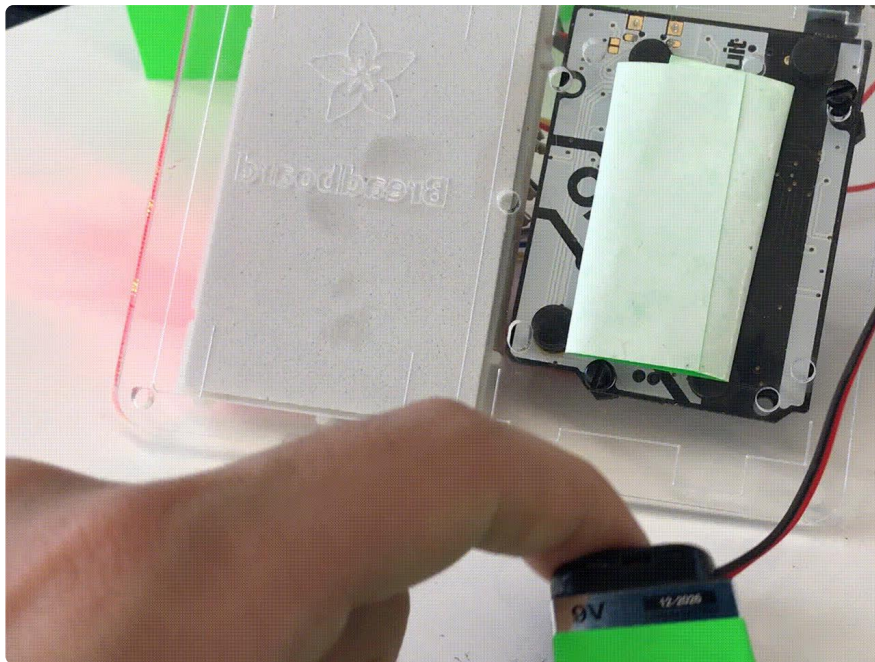

The 9V battery + clip is very handy for this circuit. You can stick it on the back of the mounting plate with double-sided tape.

Code

Copy and paste the code below into the Arduino IDE. Then, [compile and upload it to your metro \(\)](#).

```
/*
 * (PROJ03) Metro (and Metro Express) Persistence of Vision Display
 * Desc: POV display for Metro & Metro Express using 7x LEDs and 7x 560ohm Resistors
 *
 * by Brent Rubell for Adafruit Industries. Support Open Source, buy Adafruit!
 */

int spacer[8][5] = {
  {0, 0, 0, 0, 0},
  {0, 0, 0, 0, 0},
  {0, 0, 0, 0, 0},
  {0, 0, 0, 0, 0},
  {0, 0, 0, 0, 0},
  {0, 0, 0, 0, 0},
  {0, 0, 0, 0, 0},
  {0, 0, 0, 0, 0}
};

int A[8][5] = {
  {0, 1, 1, 1, 0},
  {1, 1, 0, 1, 1},
  {1, 1, 0, 1, 1},
  {1, 1, 1, 1, 1},
  {1, 1, 0, 1, 1},
  {1, 1, 0, 1, 1},
  {1, 1, 0, 1, 1},
  {0, 0, 0, 0, 0}
};
```

```

int B[8][5] = {
    {1, 1, 1, 1, 0},
    {1, 1, 0, 1, 1},
    {1, 1, 0, 1, 1},
    {1, 1, 1, 1, 0},
    {1, 1, 0, 1, 1},
    {1, 1, 0, 1, 1},
    {1, 1, 1, 1, 0},
    {0, 0, 0, 0, 0}
};

int C[8][5] = {
    {0, 1, 1, 1, 0},
    {1, 1, 0, 1, 1},
    {1, 1, 0, 0, 0},
    {1, 1, 0, 0, 0},
    {1, 1, 0, 0, 0},
    {1, 1, 0, 1, 1},
    {0, 1, 1, 1, 0},
    {0, 0, 0, 0, 0}
};

int D[8][5] = {
    {1, 1, 1, 0, 0},
    {1, 1, 0, 1, 1},
    {1, 1, 0, 1, 1},
    {1, 1, 0, 1, 1},
    {1, 1, 0, 1, 1},
    {1, 1, 0, 1, 1},
    {1, 1, 1, 1, 0},
    {0, 0, 0, 0, 0}
};

int E[8][5] = {
    {1, 1, 1, 1, 1},
    {1, 1, 0, 0, 0},
    {1, 1, 0, 0, 0},
    {1, 1, 1, 1, 0},
    {1, 1, 0, 0, 0},
    {1, 1, 0, 0, 0},
    {1, 1, 1, 1, 1},
    {0, 0, 0, 0, 0}
};

int F[8][5] = {
    {1, 1, 1, 1, 1},
    {1, 1, 0, 0, 0},
    {1, 1, 0, 0, 0},
    {1, 1, 1, 1, 0},
    {1, 1, 0, 0, 0},
    {1, 1, 0, 0, 0},
    {1, 1, 0, 0, 0},
    {0, 0, 0, 0, 0}
};

int G[8][5] = {
    {0, 1, 1, 1, 0},
    {1, 1, 0, 1, 1},
    {1, 1, 0, 0, 0},
    {1, 1, 0, 1, 1},
    {1, 1, 0, 1, 1},
    {1, 1, 0, 0, 1},
    {0, 1, 1, 1, 1},
    {0, 0, 0, 0, 0}
};

int H[8][5] = {
    {1, 1, 0, 1, 1},
    {1, 1, 0, 1, 1},

```

```

    {1, 1, 0, 1, 1},
    {1, 1, 1, 1, 1},
    {1, 1, 0, 1, 1},
    {1, 1, 0, 1, 1},
    {1, 1, 0, 1, 1},
    {0, 0, 0, 0, 0}
};

int I[8][5] = {
    {0, 0, 0, 0, 0},
    {1, 1, 1, 1, 1},
    {0, 0, 1, 0, 0},
    {0, 0, 1, 0, 0},
    {0, 0, 1, 0, 0},
    {0, 0, 1, 0, 0},
    {1, 1, 1, 1, 1},
    {0, 0, 0, 0, 0}
};

int J[8][5] = {
    {0, 0, 0, 1, 1},
    {0, 0, 0, 1, 1},
    {0, 0, 0, 1, 1},
    {0, 0, 0, 1, 1},
    {1, 0, 0, 1, 1},
    {1, 0, 0, 1, 1},
    {0, 1, 1, 0, 0},
    {0, 0, 0, 0, 0}
};

int K[8][5] = {
    {0, 0, 0, 0, 0},
    {1, 0, 0, 1, 0},
    {1, 0, 1, 0, 0},
    {1, 1, 0, 0, 0},
    {1, 1, 0, 0, 0},
    {1, 0, 1, 0, 0},
    {1, 0, 0, 1, 0},
    {0, 0, 0, 0, 0}
};

int L[8][5] = {
    {1, 1, 0, 0, 0},
    {1, 1, 0, 0, 0},
    {1, 1, 0, 0, 0},
    {1, 1, 0, 0, 0},
    {1, 1, 0, 0, 0},
    {1, 1, 1, 1, 1},
    {1, 1, 1, 1, 1},
    {0, 0, 0, 0, 0}
};

int M[8][5] = {
    {1, 0, 0, 0, 1},
    {1, 1, 0, 1, 1},
    {1, 0, 1, 0, 1},
    {1, 0, 1, 0, 1},
    {1, 0, 1, 0, 1},
    {1, 0, 1, 0, 1},
    {1, 0, 1, 0, 1},
    {0, 0, 0, 0, 0}
};

int N[8][5] = {
    {1, 0, 0, 0, 1},
    {1, 1, 0, 0, 1},
    {1, 0, 1, 0, 1},
    {1, 0, 0, 1, 1},
    {1, 0, 0, 0, 1},

```

```

    {1, 0, 0, 0, 1},
    {1, 0, 0, 0, 1},
    {0, 0, 0, 0, 0}
};

int O[8][5] = {
    {1, 1, 1, 1, 1},
    {1, 0, 0, 0, 1},
    {1, 0, 0, 0, 1},
    {1, 0, 0, 0, 1},
    {1, 0, 0, 0, 1},
    {1, 0, 0, 0, 1},
    {1, 0, 0, 0, 1},
    {1, 1, 1, 1, 1},
    {0, 0, 0, 0, 0}
};

int P[8][5] = {
    {1, 1, 1, 1, 0},
    {1, 0, 0, 0, 1},
    {1, 0, 0, 0, 1},
    {1, 1, 1, 1, 0},
    {1, 0, 0, 0, 0},
    {1, 0, 0, 0, 0},
    {1, 0, 0, 0, 0},
    {0, 0, 0, 0, 0}
};

int Q[8][5] = {
    {0, 1, 1, 1, 0},
    {1, 0, 0, 0, 1},
    {1, 0, 0, 0, 1},
    {1, 0, 0, 0, 1},
    {1, 0, 1, 0, 1},
    {1, 0, 0, 1, 0},
    {0, 1, 1, 0, 1},
    {0, 0, 0, 0, 0}
};

int R[8][5] = {
    {1, 1, 1, 1, 0},
    {1, 0, 0, 1, 0},
    {1, 0, 0, 1, 0},
    {1, 1, 1, 1, 0},
    {1, 1, 0, 0, 0},
    {1, 0, 1, 0, 0},
    {1, 0, 0, 1, 0},
    {0, 0, 0, 0, 0}
};

int S[8][5] = {
    {0, 1, 1, 1, 1},
    {0, 1, 0, 0, 1},
    {0, 1, 0, 0, 0},
    {0, 0, 1, 0, 0},
    {0, 0, 0, 1, 0},
    {1, 0, 0, 1, 0},
    {1, 1, 1, 1, 0},
    {0, 0, 0, 0, 0}
};

int T[8][5] = {
    {1, 1, 1, 1, 1},
    {1, 0, 1, 0, 1},
    {1, 0, 1, 0, 1},
    {0, 0, 1, 0, 0},
    {0, 0, 1, 0, 0},
    {0, 0, 1, 0, 0},
    {0, 0, 1, 0, 0},
    {0, 0, 0, 0, 0}
};

```

```

};

int U[8][5] = {
    {1, 0, 0, 0, 1},
    {1, 0, 0, 0, 1},
    {1, 0, 0, 0, 1},
    {1, 0, 0, 0, 1},
    {1, 0, 0, 0, 1},
    {1, 0, 0, 0, 1},
    {1, 1, 1, 1, 1},
    {0, 0, 0, 0, 0}
};

int V[8][5] = {
    {1, 0, 0, 0, 1},
    {1, 0, 0, 0, 1},
    {1, 0, 0, 0, 1},
    {1, 0, 0, 0, 1},
    {1, 0, 0, 0, 1},
    {0, 1, 0, 1, 0},
    {0, 0, 1, 0, 0},
    {0, 0, 0, 0, 0}
};

int W[8][5] = {
    {1, 0, 0, 0, 1},
    {1, 0, 0, 0, 1},
    {1, 0, 0, 0, 1},
    {1, 0, 0, 0, 1},
    {1, 0, 1, 0, 1},
    {1, 0, 1, 0, 1},
    {1, 1, 1, 1, 1},
    {0, 0, 0, 0, 0}
};

int X[8][5] = {
    {1, 0, 0, 0, 1},
    {0, 1, 0, 1, 0},
    {0, 0, 1, 0, 0},
    {0, 0, 1, 0, 0},
    {0, 1, 0, 1, 0},
    {1, 0, 0, 0, 1},
    {0, 0, 0, 0, 0},
    {0, 0, 0, 0, 0}
};

int Y[8][5] = {
    {0, 0, 0, 0, 0},
    {0, 0, 0, 0, 0},
    {0, 1, 0, 1, 0},
    {0, 1, 0, 1, 0},
    {0, 1, 1, 1, 0},
    {0, 0, 1, 0, 0},
    {0, 0, 1, 0, 0},
    {0, 0, 0, 0, 0}
};

int Z[8][5] = {
    {0, 0, 0, 0, 0},
    {1, 1, 1, 1, 1},
    {0, 0, 0, 1, 1},
    {0, 0, 1, 1, 0},
    {0, 1, 1, 0, 0},
    {1, 1, 0, 0, 0},
    {1, 1, 1, 1, 1},
    {0, 0, 0, 0, 0}
};

```

```

// LED pins
int LEDPins[] = {2, 3, 4, 5, 6, 7, 8, 9};

// space between the letters
float letterSpacing = 0.5;

void setup() {
  // start serialmon.
  Serial.begin(9600);
  // set all leds to output mode
  for (int pin = 0; pin < 8; pin++) {
    pinMode(LEDPins[pin], OUTPUT);
  }
}

void loop() {
  printLetter(M);
  printLetter(spacer);
  printLetter(E);
  printLetter(spacer);
  printLetter(T);
  printLetter(spacer);
  printLetter(R);
  printLetter(spacer);
  printLetter(O);
  printLetter(spacer);
  // delay 2s
  delay(2);
}

// outputs a letter to the POV Display
void printLetter(int letter[8][5]) {
  // row of letter array
  for (int j = 0; j < 5; j++)
  {
    Serial.print("\nRow # ");
    Serial.print(j);
    Serial.println(".");
    // column of letter array
    for (int i = 0; i < 8; i++) {
      // check for 1 within column6
      if (letter[i][j] == 1) {
        Serial.println("1 detected");
        digitalWrite(LEDPins[i], HIGH);
      }
      else {
        Serial.println("0 detected");
        digitalWrite(LEDPins[i], LOW);
      }
    }
    delay(letterSpacing);
  }
}
}

```

I need help

I can't get a good photograph of the MetroPOV in action

Try checking the next section of this guide. We suggest some techniques, and even an app.

I don't see the LEDs lighting up in different patterns

Check your wiring, the led's are connected to pins 2, 3, 4, 5, 6, 7, 8, and 9 on the Metro or Metro Express

Nothing's working, I'm getting nowhere

Don't fear, [post up in the Adafruit Support Forums](#) and we will get back to you as soon as we can. ()

Using MetroPOV

Taking Photos

It's a bit tricky to get photos of the MetroPOV in-action. We have a few tricks and tips to help photograph your MetroPOV:

Stability and Shutter Speed: Leave the shutter open (we found 2" to 4" is a good time-frame) or look for long-exposure apps on the app store. Since your camera's sensor/shutter is open, it's important to keep the camera stable. Use a tripod, or leave it on a sturdy desk.

Keep the light down: It's very hard to get good photos of the MetroPOV operating in a bright environment. Wait for night-time or find a dark room (we used a room with all of the lights off when taking photos for this guide).

GIF'ing your MetroPOV Text

You can make animated GIFS by combining multiple long-exposure pictures together in the photo editor of your choice. We also found success using Pablo, a fantastic light-painting application for [iOS \(\)](#) and [Android \(\)](#). Tinker around with settings (specifically shutter speed and exposure) until you find one that looks great.

Light Painting with MetroPOV



Mistakes while taking photos can often produce beautiful art. Try drawing letters with the MetroPOV and move it around. Ride a skateboard while someone takes a picture of you, spin in a chair. Experiment and try different techniques and ideas!

PROJ03: Music Box



Music boxes are clockwork mechanical instruments that play music when opened. You are going to take the Music Box into the 21st Century - instead of programming the music box by modifying a metal cylinder, you will be programming a beautiful song to the Metro. When opened, the music box will play a song and the LCD will show the notes as they play.

This project is customizable in a few ways: you can use your own box (maybe you have a jewelry box, an old cigar box, or an Adafruit box) and/or program your own music.

Parts



Photo Sensor

If you'd like to order another photoresistor from the Adafruit shop, [click here!](#) ()



16x2 Character LCD

If you'd like to buy a white-on-blue 16x2 character lcd from the Adafruit shop, [click here!](#) ()



Piezo Buzzer

If you'd like to order another Piezo Buzzer from the Adafruit shop, [click here!](#) ()



10K Ohm Resistor

Colors: Brown > Black > Orange

If you'd like to order more 10k ohm pull-up resistors from the Adafruit shop, [click here!](#) ()



Breadboard Wiring Bundle

If you'd like to order more wires from the Adafruit shop [click here!](#) ()

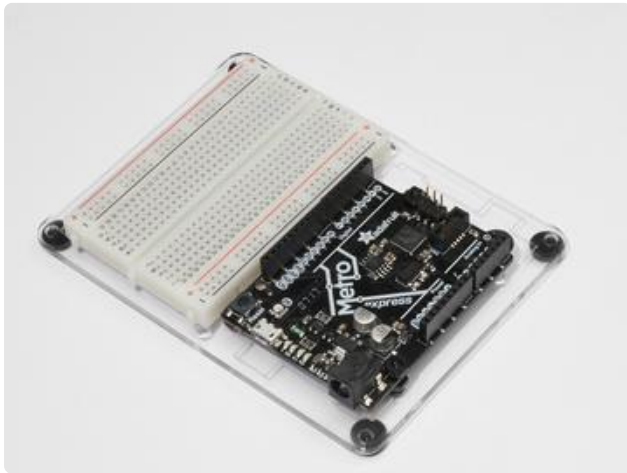

Adafruit Metro (or Metro Express) + Breadboard + Mounting Plate
If you have not assembled this, we have a [handy guide!](#) ()

If you'd like to order an extra plastic mounting plate (), Adafruit Metro (), Adafruit Metro Express (), or Mini-Breadboard () from the Adafruit Shop click [here!](#)

Wiring

Diagram

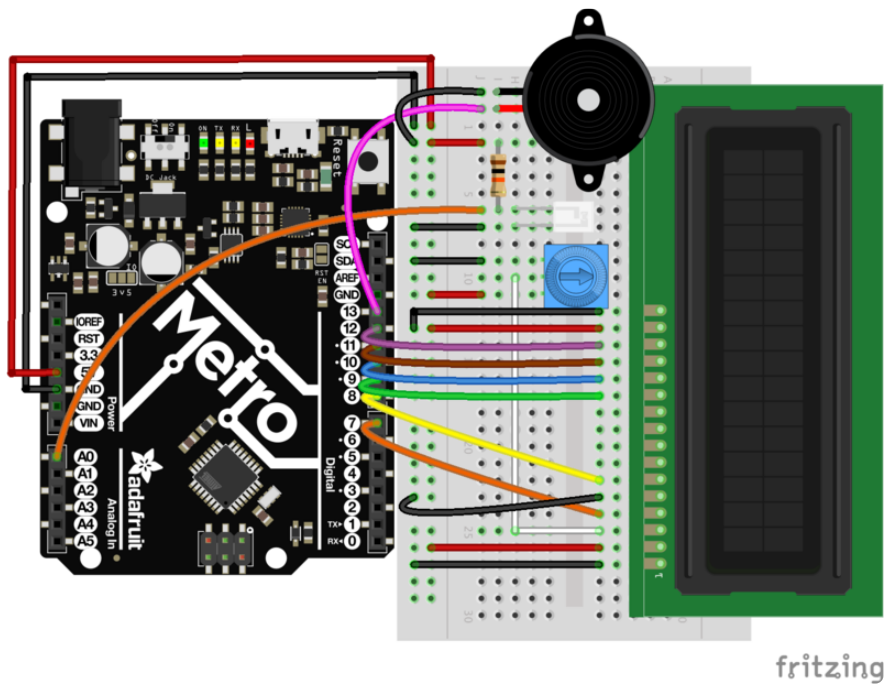

Assembly

If you want to use an Adafruit box (or any other cardboard box), there are modifications to make your circuit fit better.

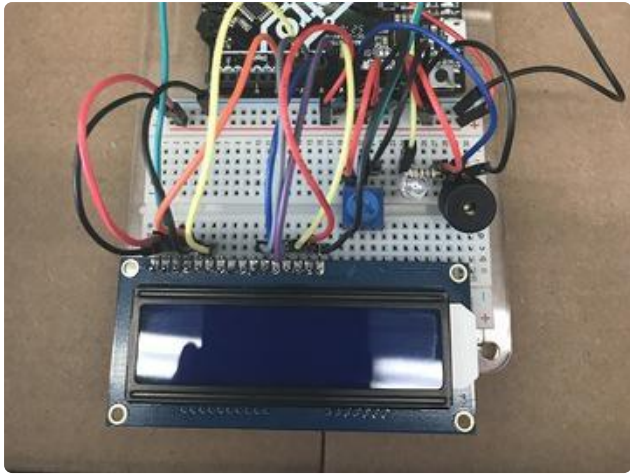

First, place the circuit in the center of the box. You can tape it down to temporarily keep it in place.

Make sure the photo light sensor is not blocked by wires. Move wires around if you need to.

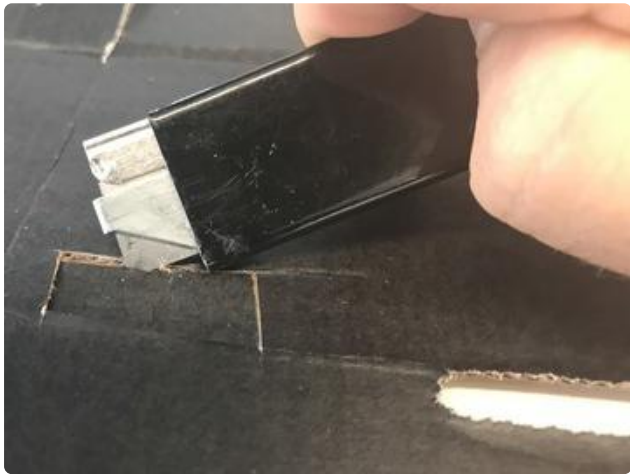

Next, cut a small rectangle into the side to fit the USB cable. Be careful while cutting

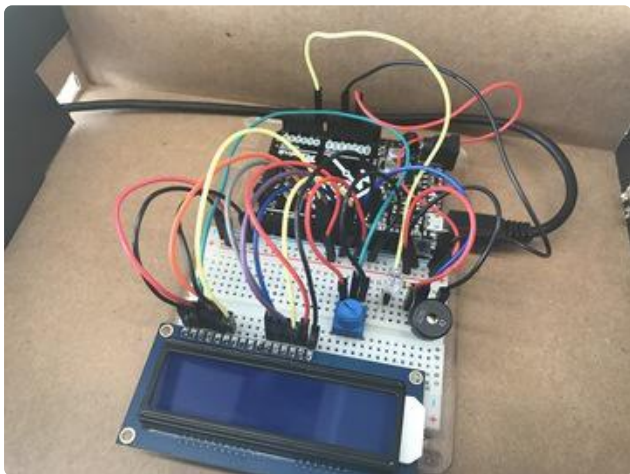

Finally, pull the wire through the hole you cut and connect it to the Metro.

Code

Calibrating the Music Box

In order to get an accurate reading, close the music box and run the code below. Then, open your serial monitor. It should output the light level, this is the darkest the box will get so we'll calibrate this value.

In your code, change the following line:

```
int dark = 650; -> int dark = your measured value
```

When you re-run the code, the serial monitor should print "box closed.." when the box is closed. If you wired the backlight to Pin 13, the LCD backlight should also turn off.

```
/*
 * (PROJ03) Metro (and Metro Express!) Music Box
 * Desc: 21st century music box: Plays a melody when the box is open.
 * Circuit: Piezo, 16x2 LCD, Photo Light Sensor
 *
 * by Brent Rubell for Adafruit Industries.  Support Open Source Hardware, buy
 Adafruit!
 *
 */

// include the lcd library code
#include <LiquidCrystal.h>
// initialize the library with the numbers of the interface pins
LiquidCrystal lcd(7, 8, 9, 10, 11, 12);

// Piezo code.
int speakerPin = 5;
int length = 15; // the number of notes
char notes[] = "ccggaagffeeddc "; // a space represents a rest
int beats[] = { 1, 1, 1, 1, 1, 1, 2, 1, 1, 1, 1, 1, 1, 2, 4 };
int tempo = 300;

// Photo Light Sensor Pin
int lightPin = 0;
// Measured Darkness
int dark = 650;

// LCD Backlight Pin
int backlightPin = 13;

void playTone(int tone, int duration) {
  for (long i = 0; i < duration * 1000L; i += tone * 2) {
    digitalWrite(speakerPin, HIGH);
    delayMicroseconds(tone);
    digitalWrite(speakerPin, LOW);
    delayMicroseconds(tone);
  }
}

void playNote(char note, int duration) {
  char names[] = { 'c', 'd', 'e', 'f', 'g', 'a', 'b', 'C' };

```

```

int tones[] = { 1915, 1700, 1519, 1432, 1275, 1136, 1014, 956 };

// play the tone corresponding to the note name
for (int i = 0; i < 8; i++) {
  if (names[i] == note) {
    playTone(tones[i], duration);
  }
}

void setup() {
  // set up the serial monitor
  Serial.begin(9600);
  // set up the LCD's cols/rows
  lcd.begin(16, 2);
  // set speaker as an output
  pinMode(speakerPin, OUTPUT);
  // set lcd backlight as an output
  pinMode(backlightPin, OUTPUT);
}

void loop() {
  // read the lightLevel
  int lightLevel = analogRead(lightPin);
  Serial.println("Light Level -> ");
  Serial.println(lightLevel);

  // check lightLevel against dark level (should be set manually by the user, check
  serial mon.)
  if(lightLevel < dark)
  {
    // Box is OPEN!
    digitalWrite(backlightPin, HIGH);
    lcd.clear();
    Serial.println("Box open, playing music!");
    for (int i = 0; i < length; i++) {
      if(notes[i] == ' ') {
        // rest
        delay(beats[i] * tempo);
        // print a space to indicate a rest
        lcd.print(" ");
      }
      else {
        // play notes in notes[]
        playNote(notes[i], beats [i] * tempo);
        // display current note on the lcd
        lcd.print(notes[i]);
      }
      // pause between notes
      delay(tempo/2);
    }
  }
  else{
    // box is closed
    // turn LCD off
    digitalWrite(backlightPin, LOW);
    lcd.clear();
    lcd.print("box closed...");
    Serial.println("Box closed, don't play music.");
  }
}

```

Encountering Problems?

My LCD is not displaying anything.

Check the LCD Wiring guide in CIRC14 to double-check everything is wired correctly.

My music box is still too sensitive, or it's not sensitive enough.

`int dark` directly controls how dark or bright the environment inside your music box is. If you find it triggering too easily, decrease its value.

It still doesn't work

We'll help you out! [Post up in the Adafruit Support Forums](#) and we will get back to you as soon as we can. ()

Make It Better

Bored of your Music Box? Want to go add onto this circuit? Here's some ideas for you to springboard off of and learn new skills in the process

Music Composer

Write your own melody and become a composer, or adapt an older song to play on the piezo. (tip: Check CIRC06's Make It Better section for more details on the piezo speaker)

Unconventional Enclosures

There are thousands of ways to enclose your electronics projects! Using non-conventional enclosures, such as cigar boxes, are a way to both protect your project and make it look nicer. Try using a different box to hold your music box.

Hint: What should you change in order to use a new box with a light sensor? Take a look at the code section.

Answer: Re-calibrating the light sensor is required. Change the value of int dark to the new darkness value.

Annoy-a-Box

Want to annoy your friends and family with this circuit? Change the code to use a high pitched whine, or make the whine go between pitches like a bee. Make it portable and throw it under a couch.

Secret Message Box

You need to deliver a secret message to somebody, but writing too permanent. The time-sensitive box is a box to deliver to a friend, classmate, or an international spy containing a secret message on the character lcd.

How it works: Once the box is opened, the timer starts to count down the time remaining on the second line of the LCD while the message is displayed. Once the timer runs out, the character lcd clears the message and you cant show the message again.

PROJ04: Fidget Spinner Tachometer

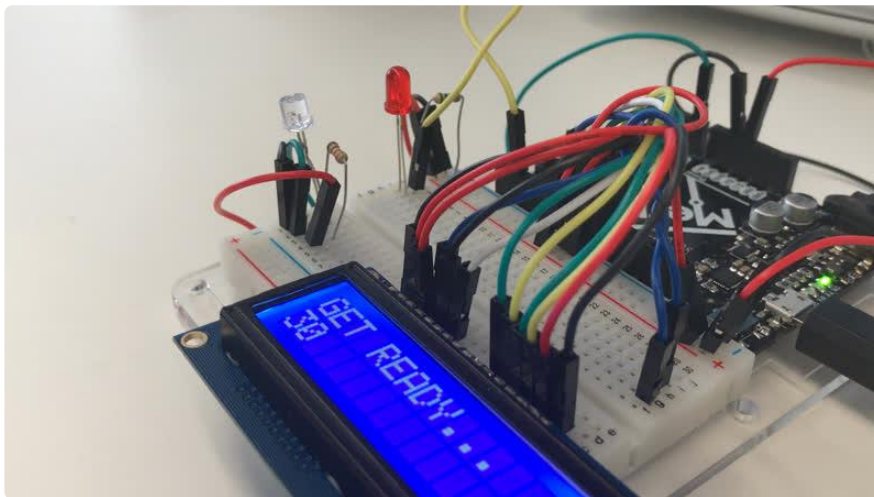

Fidget spinners are fun toys that help relieve stress. They spin on a bearing, and can reach really high revolutions per minute (RPM). We are going to build a Tachometer, an instrument which measures RPM, for your fidget spinner.

We included some fun features into [Tony D's original Circuit Playground fidget spinner code \(\)](#)

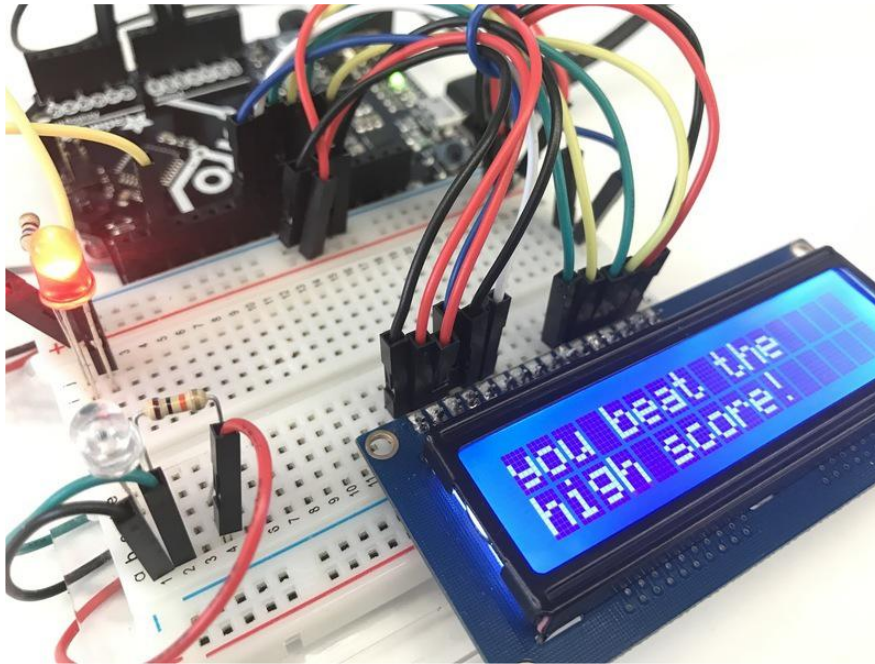

Like a RPM high score game to compete with your friends (or to pit different spinners against each other)



And a countdown clock to let you time your spins better.

Parts



5mm Red LED

If you'd like to order more red LEDs (they make great indicator lights!) from the [Adafruit shop](#), click here! ()



Photo Sensor

If you'd like to order another photoresistor from the [Adafruit shop](#), click here! ()



560 Ohm Resistor

Colors: Green > Blue > Brown

If you'd like to order more resistors from the [Adafruit shop](#) click here! (they are 470ohm but they'll be fine) ()



10K Ohm Resistor

Colors: Brown > Black > Orange

If you'd like to order more 10k ohm pull-up resistors from the Adafruit shop, click [here!](#) ()



Breadboard Wiring Bundle

If you'd like to order more wires from the Adafruit shop click [here!](#) ()

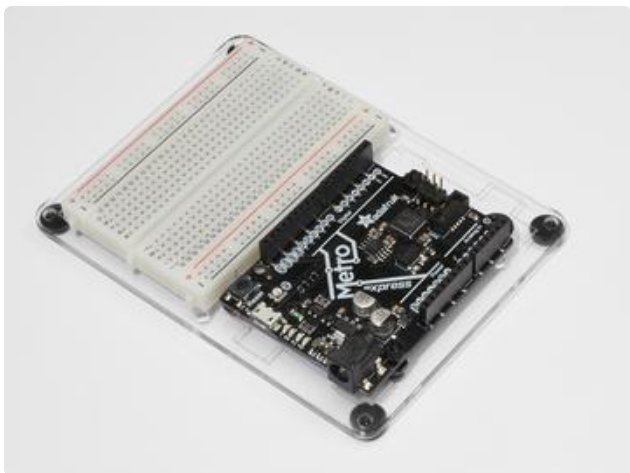

Adafruit Metro (or Metro Express) + Breadboard + Mounting Plate

If you have not assembled this, we have a [handy guide!](#) ()

If you'd like to order an extra plastic mounting plate (), Adafruit Metro (), Adafruit Metro Express (), or Mini-Breadboard () from the Adafruit Shop click [here!](#)

Wiring

Diagram

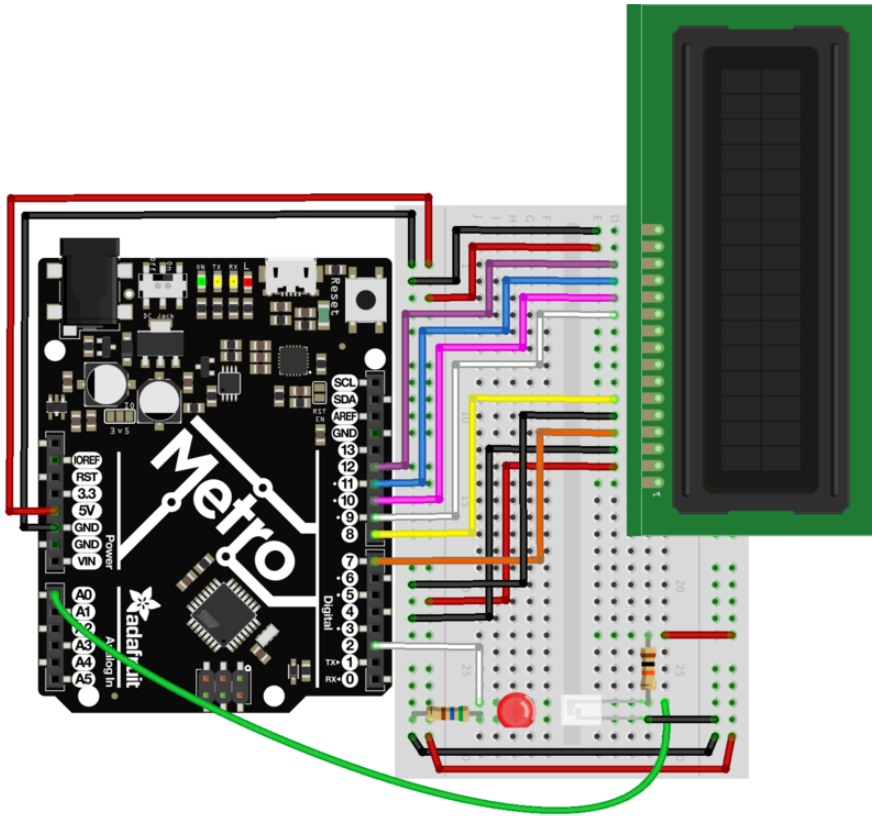

fritzing

Assembly Tips

Fidget spinners love to rip wires out of breadboards at high RPM. This section details how to avoid that from happening.

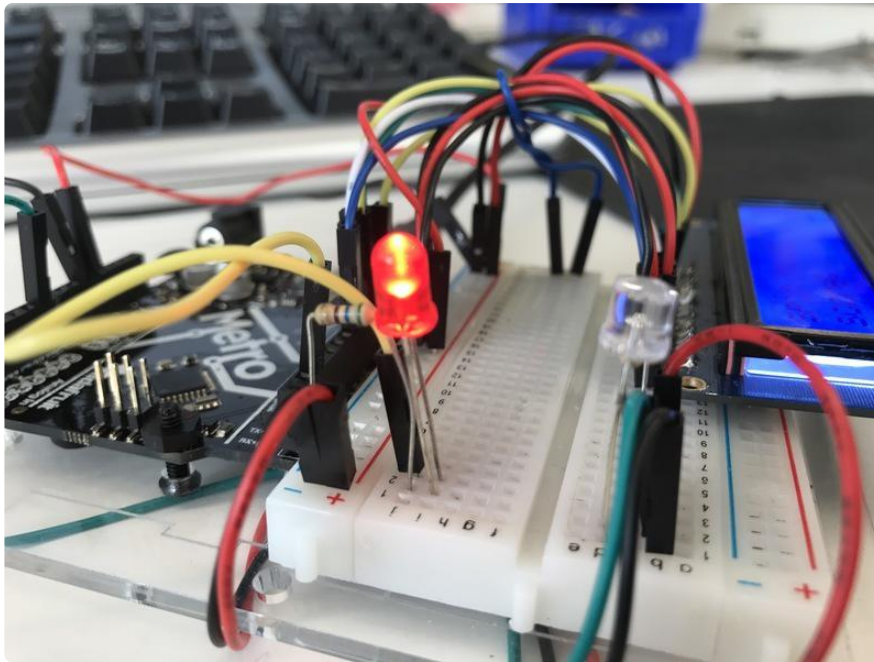

There is a bit of clean-up involved with this wiring. Spinners snag onto wires. We tried to make the clean-up as simple as possible by utilizing the parts from your kit.

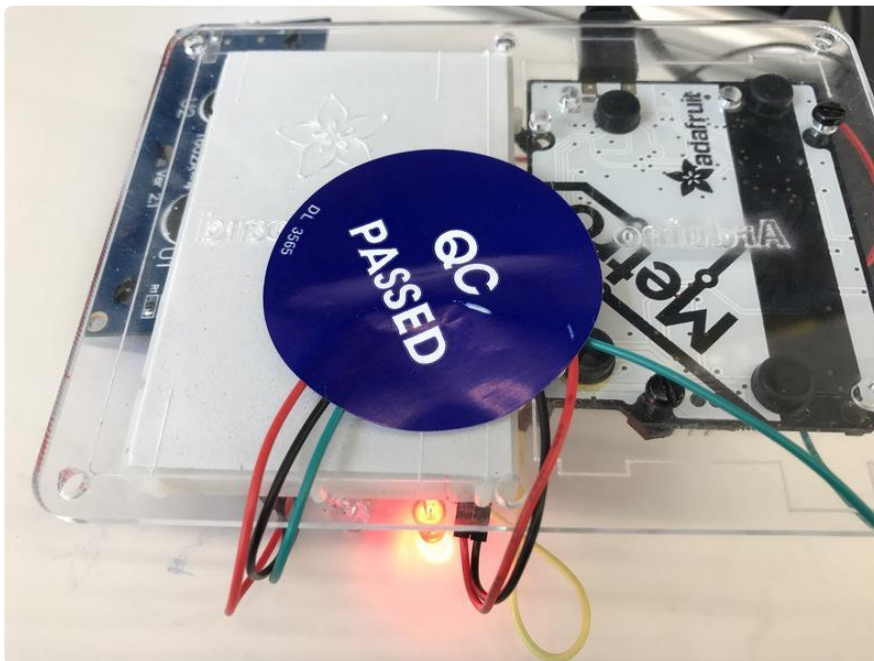

First, let's clean up the Spin Zone. The area in-between the light-sensor and the LED is the area for the spinner to move around. We suggest using the long wires included in the breadboard wiring bundle. Tuck the wires in underneath the board and use a piece of tape (or in our case, a quality control sticker) to pin them down.

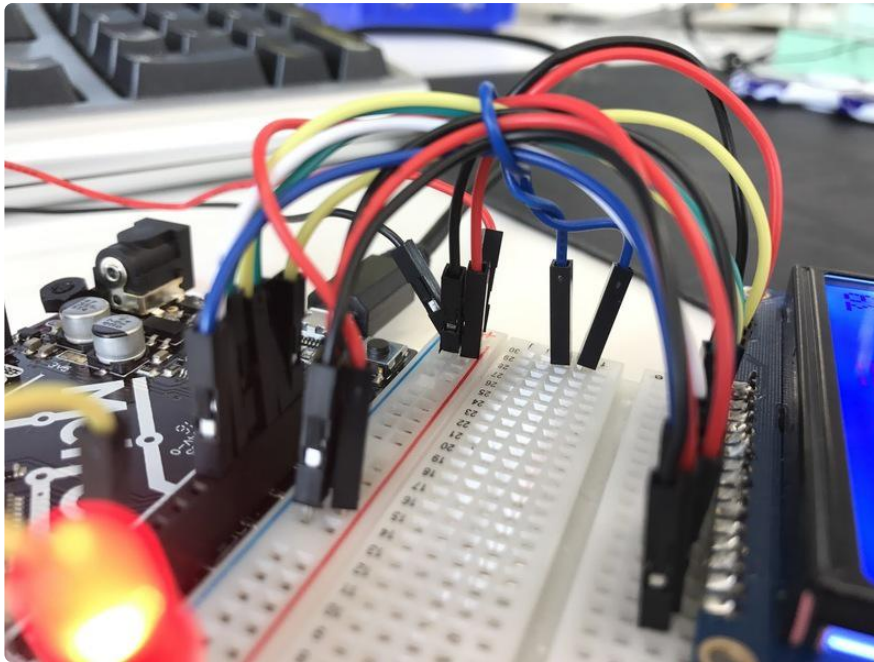

Next, take a shorter breadboarding wire and wrap it around the wires for the LCD. You can also use a zip-tie for a more permanent hold. Plug the ends of this wire into the breadboard.

Code

Copy/Paste the following code into a blank Arduino sketch. Then, compile and upload it to your Metro. If you see the LED running through the script, continue to the next page. If you're not seeing it work properly, check the FAQ below for help.

```
/*
 * (PROJ04) Metro (and Metro Express!) Fidget Spinner Tachometer
 * Desc: Count fidget spinner RPMs (and beat your high scores)
 *
 * Original code by Tony Dicola for Adafruit Industries
 * by Brent Rubell and Asher Lieber for the Metro Explorers Guide
 */

// include the LCD library code:
#include <LiquidCrystal.h>
// initialize the library with the numbers of the interface pins
LiquidCrystal lcd(7, 8, 9, 10, 11, 12);

// How many arms does the spinner have?
#define SPINNER_ARMS      3
// 1kB sample size
#define SAMPLE_DEPTH      256
// delay between light samples
#define SAMPLE_PERIOD_US  150
// min. speed, depends on reflective-ness of spinner, noise thresh.
// #define THRESHOLD      127
// wait 2s between measurements
#define MEASURE_PERIOD_MS 2000

// rpm high score
float rpmHighScore = 0.00;
```

```

// threshold value
int threshold;
// photo light sensor pin
int photoSensor = A0;
// led pin
int led = 2;

void setup() {
  // Init. serial monitor @ 115200 baud
  Serial.begin(9600);
  // set up the LCD's number of columns and rows:
  lcd.begin(16, 2);
  lcd.print("Metro Tachometer");
  // set up LED
  pinMode(led, OUTPUT);
}

void loop() {
  int sensorCalibrate = 0;
  // Set depending on light balance
  threshold = 40;

  // PAUSE between measurements
  lcd.clear();
  lcd.print("GET READY...");
  analogWrite(led, 255);

  // pause between sampling sensor
  // shown as a countdown on the screen!
  for (int i = 3500; i > 0; i--) {
    lcd.setCursor(0,1);
    lcd.print(i/100);
  }

  // init. empty sample array
  uint16_t samples[SAMPLE_DEPTH] = {0};
  // start time
  uint32_t start = micros();

  // lcd during spin
  lcd.clear();
  lcd.print("SPIN IT");
  lcd.setCursor(0,1);
  lcd.print("score: ");
  lcd.setCursor(10,1);
  lcd.print(rpmHighScore);

  for (int i = 0; i < SAMPLE_DEPTH; i++) {
    // sample the photo light sensor
    samples[i] = analogRead(photoSensor);
    // serial output
    Serial.print("\nSample: ");
    Serial.print(samples[i]);
    // keep the player occupied while sampling
    if (i == int(SAMPLE_DEPTH/4)) {
      lcd.clear();
      lcd.print("keep going!");
      lcd.setCursor(10,1);
      lcd.print(rpmHighScore);
    }
    else if (i == int(SAMPLE_DEPTH/3)) {
      lcd.clear();
      lcd.print("almost there!");
      lcd.setCursor(10,1);
      lcd.print(rpmHighScore);
    }
  }

  delayMicroseconds(SAMPLE_PERIOD_US);
}

```

```

}

// time elapsed (uS)
uint32_t elapsed_uS = micros() - start;
// time elapsed (sec)
float elapsed = elapsed_uS / 1000000.0;

// Find the min and max values in the collected samples.
uint16_t minval = samples[0];
uint16_t maxval = samples[0];
for (int i=1; i<SAMPLE_DEPTH; ++i) {
    minval = min(minval, samples[i]);
    maxval = max(maxval, samples[i]);
}

// Serial Monitor Values
Serial.print("\n Samples taken, : ");
Serial.print(elapsed, 3);
Serial.print(" seconds");
Serial.print("\n Max Sample Val: ");
Serial.print(maxval);
Serial.print("\n Min Sample Val: ");
Serial.print(minval);

// Check the amplitude of the signal (difference between min and max)
// is greater than the threshold to continue detecting speed.
uint16_t amplitude = maxval - minval;
if (amplitude < threshold) {
    // Didn't make it past the threshold so start over with another measurement
    attempt.
    lcd.clear();
    lcd.println("didn't spin fast enough, re-spin!");
    Serial.print("\n DIDNT PASS THRESHOLD, RE-TAKING MEASUREMENT..");
    return;
}

// Compute midpoint of the signal (halfway between min and max values).
uint16_t midpoint = minval + (amplitude/2);

// Count how many midpoint crossings were found in the signal.
// These are instances where two readings either straddle or land on
// the midpoint. The midpoint crossings will happen twice for every
// complete sine wave cycle (once going up and again coming down).
int crossings = 0;
for (int i=1; i<SAMPLE_DEPTH; ++i) {
    uint16_t p0 = samples[i-1];
    uint16_t p1 = samples[i];
    if ((p1 == midpoint) ||
        ((p0 < midpoint) && (p1 > midpoint)) ||
        ((p0 > midpoint) && (p1 < midpoint))) {
        crossings += 1;
    }
}

// Compute signal frequency, RPM, and period.
// The period is the amount of time it takes for a complete
// sine wave cycle to occur. You can calculate this by dividing the
// amount of time that elapsed during the measurement period by the
// number of midpoint crossings cut in half (because each complete
// sine wave cycle will have 2 midpoint crossings). However since
// fidget spinners have multiple arms you also divide by the number
// of arms to normalize the period into a value that represents the
// time taken for a complete revolution of the entire spinner, not
// just the time between one arm and the next.

Serial.print("\n MP Crossings: ");
Serial.print(crossings);
Serial.print("\n Elapsed: ");

```



```

Serial.print(elapsed);

float period = elapsed / (crossings / 2.0 / SPINNER_ARMS);

Serial.print("\n Period: ");
Serial.print(period);

// Once the period is calculated it can be converted into a frequency
// value (i.e revolutions per second, how many times the spinner spins
// around per second) and more common RPM value (revolutions per minute,
// just multiply frequency by 60 since there are 60 seconds in a minute).
float frequency = 1.0 / period;
float rpm = frequency * 60.0;

// Print out the measured values!
Serial.print("Frequency: ");
Serial.print(frequency, 3);
Serial.print(" (hz)\t\tRPM: ");
Serial.print(rpm, 3);
Serial.print("\t\tPeriod: ");
Serial.print(period, 3);
Serial.println(" (seconds)");

lcd.clear();
lcd.setCursor(1,0);
lcd.print(rpm);
delay(2000);

// high score checker
if(rpm > rpmHighScore) {
  rpmHighScore = rpm;
  lcd.clear();
  lcd.setCursor(0,0);
  lcd.print("you beat the");
  lcd.setCursor(0,1);
  lcd.print("high score!");
  delay(2000);
}
}

```

Not Working?

LCD is blank/garbled/glitchy

Make sure all your wires are both plugged in correctly and not loose. During the assembly step where you tied everything together, make sure everything is snugly plugged into both the Metro and the breadboard.

LED not turning on?

Check the LED wiring. Possibly you have a wrong resistor value.

Still not working?

Post up on our community support forums!

Parts

This is a Metro EXPRESS PROject. It will NOT work with the regular Metro.



IR Sensor

How it's used: The IR Sensor receives and decodes incoming infrared signals from the Adafruit Mini Remote.

[If you'd like to order an extra IR receiver sensor from the Adafruit shop, click here! \(\)](#)



Mini Remote Control

How it's used: The Mini Remote control will send ir signals to the ir sensor connected to the Metro M0 Express.

[If you'd like to order an extra Mini Remote Control from the Adafruit Shop, click here! \(\)](#)



Mini-USB Cable

Make sure the Mini-USB cable you're using is charge + data and not just charge only.

[If you'd like to order a Mini-USB Cable from the Adafruit shop click here \(\)](#)



Breadboard Wiring Bundle

How it's used: We are going to connect a power, ground, and data wire to the 3 pins on the IR sensor.

If you'd like to order more wires from the Adafruit shop click [here!](#) ()

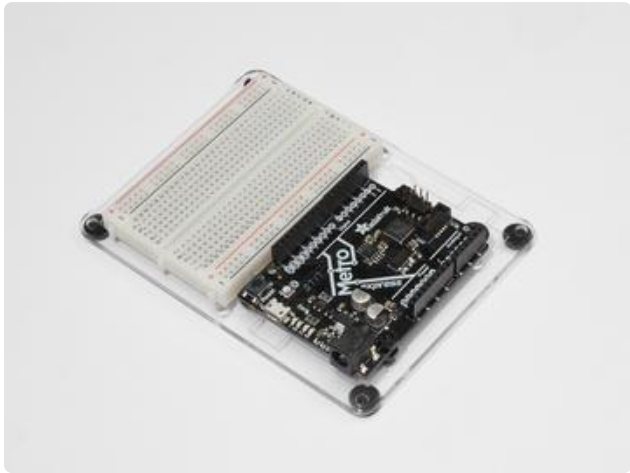

Adafruit Metro Express + Breadboard + Mounting Plate

If you have not assembled this, we have a [handy guide!](#) ()

Need an extra plastic mounting plate (), Adafruit Metro Express (), or Mini-Breadboard () from the Adafruit Shop?

Wiring

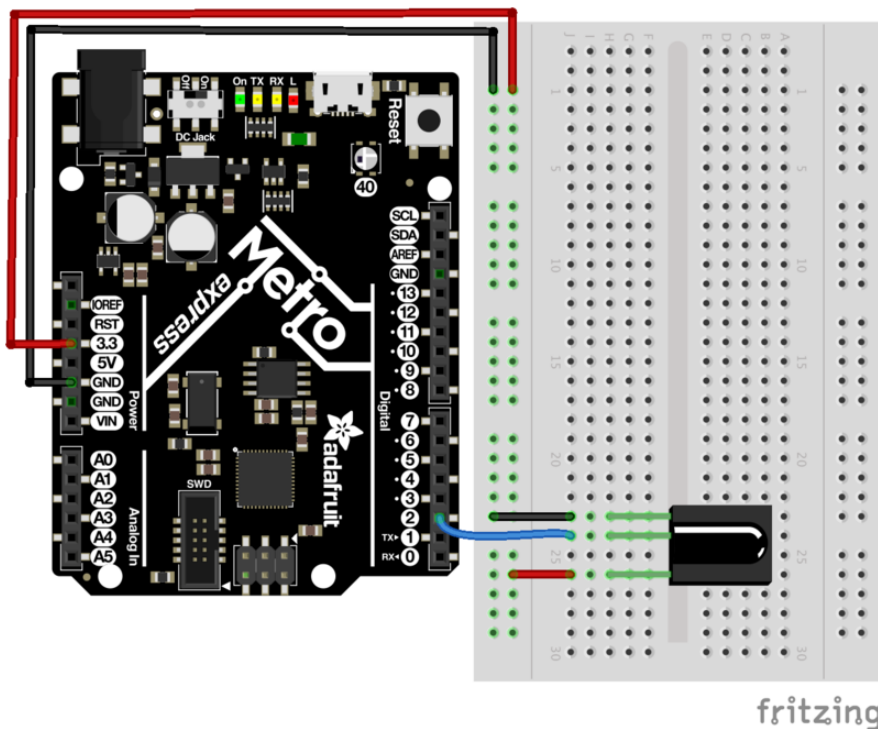

Code

We are going to use both the IRLib and Keyboard libraries for this project, so let's figure out how to combine them. This section is self-guided, as in we are going to give you the code piece-by-piece and you can follow along.

First, we want to include both the IRLibAll and Keyboard Libraries:

```
#include <IRLibAll.h>;
#include <Keyboard.h>;
```

Then, we are going to include the button codes. Since these are long numbers, they [are encoded as hexadecimal values - Colin has a great video about this topic here \(\)](#).

```
/* Remote Codes */
#define VOLUMEUP      0xfd40bf
#define VOLUMEDOWN   0xfd00ff
#define RIGHT_ARROW   0xfd50af
#define LEFT_ARROW    0xfd10ef
#define PLAYPAUSE     0xfd807f
#define SELECT_BUTTON 0xfd906f
```

We are going to define NEC as the protocol used by the Adafruit Mini remote, then create a receiver on digital pin 2. After that, create a decoder object and an integer to hold the previous code for NEC repeat codes.

```
// Adafruit Mini-Remote uses NEC, change this if you're using a different remote
#define MY_PROTOCOL NEC
// receiver on pin 2
IRrecv myReceiver(2);
// Decoder object
IRdecode myDecoder;
// NEC repeat codes for Adafruit Mini-Remote
uint32_t Previous;
```

Lastly, we are going to create a LED object on Pin #13, which is the builtin LED. We are going to use this a way to visually debug our circuit without printing out to the serial monitor.

```
const int ledPin = 13;
```

In the `setup()` loop, we are going to tell the Metro to begin control over the keyboard, start the IR Receiver, and configure the led as an output.

```
void setup() {
  // initialize control over the keyboard
```

```

Keyboard.begin();
// start the IR receiver
myReceiver.enableIRIn();
// configure status LED
pinMode(LED_BUILTIN, OUTPUT);
}

```

The `loop()` is quite complicated, but we'll break it down to make it easier. We are going to first detect if the receiver gets an input from the remote with `myReceiver.getResults()`. Then, we are going to decode it with a call to `myDecoder.decode()`.

Next, we want to check if the protocol is the same as what's used by the Mini Remote, NEC, by checking `if(myDecoder.protocolNum==MY_PROTOCOL)`. Finally, we are going to detect the repeat codes, and set the current value to the previous decoded value `if(myDecoder.value==0xFFFFFFFF {myDecoder.value=Previous;}`

```

void loop()
{
  if (myReceiver.getResults()) {
    myDecoder.decode();
    if(myDecoder.protocolNum==MY_PROTOCOL) {
      if(myDecoder.value==0xFFFFFFFF)
        myDecoder.value=Previous;

      // handle everything in here
    }
  }
}

```

Phew, now the fun part begins. [We are going to use a programming concept called a SwitchCase \(\)](#). This will let us take in one value (the value decoded by the decoder - `myDecode.value`) and perform different actions depending on what the value is.

In our case, we are going to switch based on `myDecoder.value`. The first case will be if the PLAYPAUSE button is detected (already #define'd above). We want to send the spacebar key to pause VLC playback.

```

switch(myDecoder.value) {
  case PLAYPAUSE:
    // key-play-pause
    // send the spacebar key
}

```

We are going to send 0x20, the spacebar ascii value, to the keyboard with `Keyboard.write()`. Then, we are going to turn the LED to signal the key was sent (a really easy way to visually debug your code). Next, we are going to delay, then call `Keyboard.releaseAll();` to release the key(s) pressed. Then, we are going to `break;` out of that case and finish execution.

```

Keyboard.write((char)0x20);
digitalWrite(LED_BUILTIN, HIGH);
delay(100);

```

```

// release the keys pressed
Keyboard.releaseAll();
break;

```

Now that you get the idea, we are going to provide you with the code. Try the Make It Better section if you'd like to try your hand at understanding this project better.

```

/* PROJ05: Metro Media Remote
 * Desc: Control VLC with your Adafruit Metro M0 Express!
 * by Brent Rubell and Asher Liber for Adafruit Industries
 * Requires IRLib2.x Library
 */

#include <IRLibAll.h>
#include <Keyboard.h>

/* Remote Codes */
#define VOLUMEUP      0xfd40bf
#define VOLUMEDOWN   0xfd00ff
#define RIGHT_ARROW   0xfd50af
#define LEFT_ARROW    0xfd10ef
#define PLAYPAUSE     0xfd807f
#define SELECT_BUTTON 0xfd906f
// These are some extra button codes...not used in the PROJ.
// if you want to create more functions in VLC or any other app, use these!
#define UP_ARROW      0xfda05f
#define DOWN_ARROW    0xfdb04f
#define BUTTON_0      0xfd30cf
#define BUTTON_1      0xfd08f7
#define BUTTON_2      0xfd8877
#define BUTTON_3      0xfd48b7
#define BUTTON_4      0xfd28d7
#define BUTTON_5      0xfda857
#define BUTTON_6      0xfd6897
#define BUTTON_7      0xfd18e7
#define BUTTON_8      0xfd9867
#define BUTTON_9      0xfd58a7
// Adafruit Mini-Remote uses NEC, change this if you're using a different remote
#define MY_PROTOCOL NEC

// receiver on pin 2
IRrecv myReceiver(2);
// Decoder object
IRdecode myDecoder;

// NEC repeat codes for Adafruit Mini-Remote
uint32_t Previous;

// use this option for OSX:
char ctrlKey = KEY_LEFT_GUI;
// use this option for Windows and Linux:
// char ctrlKey = KEY_LEFT_CTRL;

const int ledPin = 13;

void setup() {
  // monitor the serial at 9600baud
  Serial.begin(9600);
  // initialize control over the keyboard
  Keyboard.begin();
  // start the IR receiver
  myReceiver.enableIRIn();
  // configure status LED
  pinMode(LED_BUILTIN, OUTPUT);
  Serial.println("Listening to IR...");
}

```

```

void loop()
{
  if (myReceiver.getResults()) {
    myDecoder.decode();
    if(myDecoder.protocolNum==MY_PROTOCOL) {
      if(myDecoder.value==0xFFFFFFFF)
        myDecoder.value=Previous;
      // We used VLC for this example, but you can use any keyboard shortcuts!
      // (src: https://wiki.videolan.org/Hotkeys_table/)
      switch(myDecoder.value) {
        case PLAYPAUSE:
          // key-play-pause
          // send the spacebar key
          Keyboard.write((char)0x20);
          digitalWrite(LED_BUILTIN, HIGH);
          delay(100);
          // release the keys pressed
          Keyboard.releaseAll();
          break;
        case VOLUMEUP:
          // key-vol-up
          // vlc shortcut: ctrl + up arrow
          Keyboard.press(ctrlKey);
          Keyboard.press(KEY_UP_ARROW);
          digitalWrite(LED_BUILTIN, HIGH);
          delay(100);
          Keyboard.releaseAll();
          break;
        case VOLUMEDOWN:
          // key-vol-down
          // vlc shortcut: ctrl + down arrow
          Keyboard.press(ctrlKey);
          Keyboard.press(KEY_DOWN_ARROW);
          digitalWrite(LED_BUILTIN, HIGH);
          delay(100);
          Keyboard.releaseAll();
          break;
        case RIGHT_ARROW:
          // key-faster
          // vlc shortcut: +
          Keyboard.press('+');
          digitalWrite(LED_BUILTIN, HIGH);
          delay(100);
          Keyboard.releaseAll();
          break;
        case LEFT_ARROW:
          // key-faster
          // vlc shortcut: -
          Keyboard.press('-');
          digitalWrite(LED_BUILTIN, HIGH);
          delay(100);
          Keyboard.releaseAll();
          break;
        default:
          // if nothing else matches, do the default
          // default is optional
          break;
      }
      Previous=myDecoder.value;
    }
    digitalWrite(LED_BUILTIN, LOW);
    myReceiver.enableIRIn();
  }
}

```

I'm having trouble with this Project

Fatal error: IRLibAll.h: No such file or directory #include

The IRLib 2.x library was improperly installed. Check CIRC16's "Installing the IR Library" page for correct installation instructions.

My computer isn't responding to the remote

If you're using the Adafruit Mini-Remote, make sure you un-comment (remove the slashes) the `char ctrlKey` variable for which operating system you're using:

```
// use this option for OSX:  
char ctrlKey = KEY_LEFT_GUI;  
// use this option for Windows and Linux:  
// char ctrlKey = KEY_LEFT_CTRL;
```

If you're using your own remote control, you'll need to make modifications to the code. Check out this guide on [Sending IR Codes \(\)](#) for more info.

This project still isn't working

[Post up in the Adafruit Support Forums](#) and we will get back to you as soon as we can. ()

Make It Better

We added in some extra buttons for you in the code provided on the last page:

```
// These are some extra button codes...not used in the PROJ.  
// if you want to create more functions in VLC or any other app, use these!  
#define UP_ARROW      0xfda05f  
#define DOWN_ARROW   0xfdb04f  
#define BUTTON_0     0xfd30cf  
#define BUTTON_1     0xfd08f7  
#define BUTTON_2     0xfd8877  
#define BUTTON_3     0xfd48b7  
#define BUTTON_4     0xfd28d7  
#define BUTTON_5     0xfda857  
#define BUTTON_6     0xfd6897  
#define BUTTON_7     0xfd18e7  
#define BUTTON_8     0xfd9867  
#define BUTTON_9     0xfd58a7
```

If you'd like to use these for different commands within VLC, or maybe control Netflix or Youtube, check out the [Arduino Modifier Keys Documentation](#) (). Implement new keys, or modify your pre-existing cases within the SwitchCase to use different keys.

PROJ06: IR Laser Pet Toy

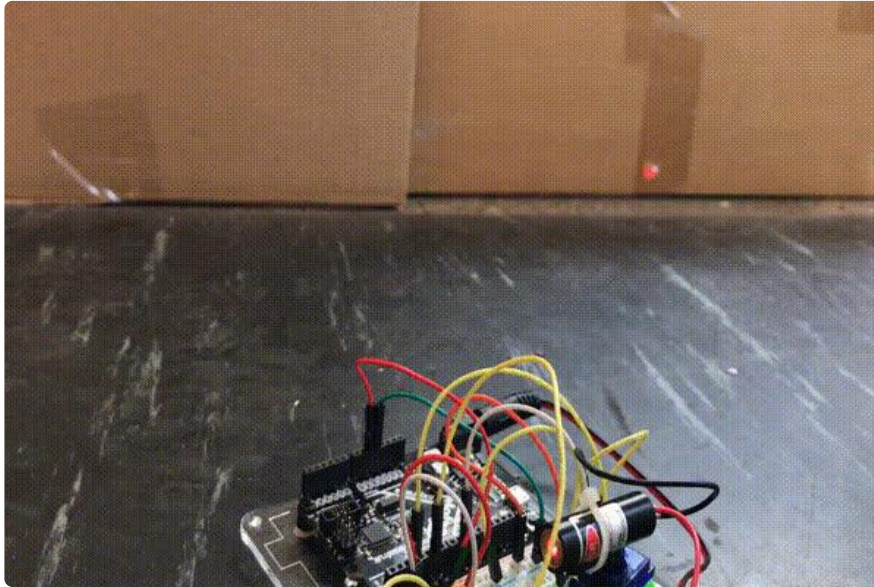

Do you want to annoy your (or your family's) pets? Maybe you want to exercise your pet in the laziest way possible? You are going to build a laser pet toy controlled by your IR remote and the Adafruit Metro.

Here's how it's going to work: a cheap-o laser pointer is affixed to the servo horn. You'll mount the servo to your breadboard with double-sided tape to give it a solid base. Then, you'll wire up your infrared sensor along with the servo and code a program that lets you annoy/exercise your pets from a safe distance

What to know about lasers and your pet

The laser pointer dot can drive both cats and dogs towards obsessive behavior because it can seek out the "prey" instinct in your pet. We strongly suggest hiding a few food treats around the room, and then letting the IR Laser Pet Toy move in the direction of the food. Your dog/cat needs to be rewarded for chasing what they consider to be their prey.

We also advise both you and your pet to avoid any direct eye exposure with the laser. Keep the laser on during play with the animal to avoid them looking at the light (switching it off/turning it on will make them turn around quickly).

Parts

This project requires an external part.

This PROJECT requires a laser pointer. We do not recommend using the Laser Diodes we sell in the Adafruit shop. Your corner store, or Amazon, sells a very low-powered laser pointer.

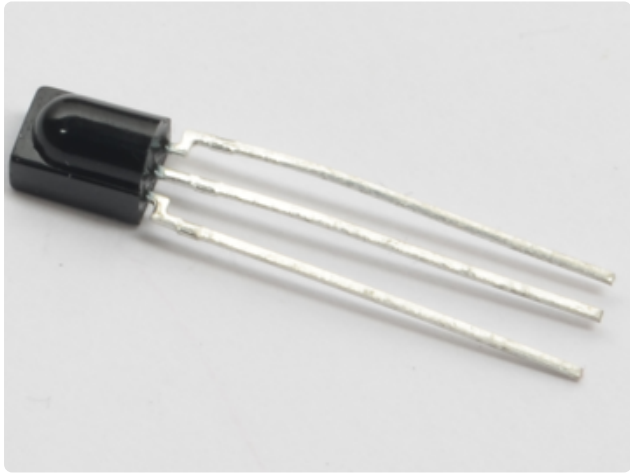

The IR Receiver is used to receive infrared signals from the remote. These signals will then be sent to the Metro, which will tell the servo where to move.



The Mini Remote contains an IR LED to transmit signals to the IR Receiver connected to the Metro M0.



The Hobby Servo will be used as a platform to rotate the laser pointer left and right.



Breadboard Wiring Bundle

If you'd like to order more wires from the Adafruit shop [click here!](#) ()

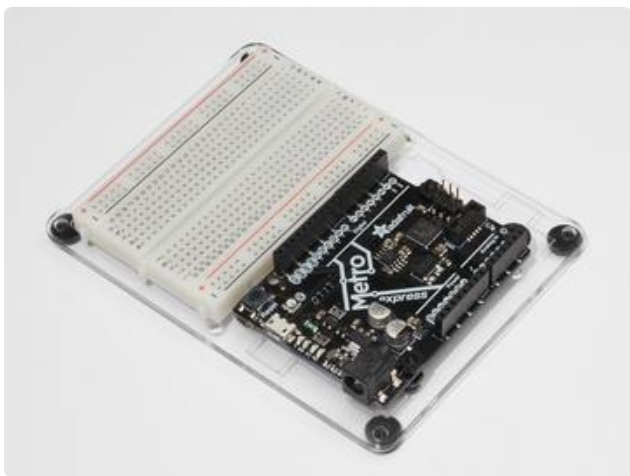

Adafruit Metro + Breadboard + Mounting Plate

If you have not assembled this, we have a [handy guide!](#) ()

If you'd like to order an extra plastic [mounting plate](#) (), [Adafruit Metro](#) (), or [Mini-Breadboard](#) () from the Adafruit Shop [click here!](#)

Wiring

There are two routes for assembly: we can either put a laser pointer on top of the servo and tape the button to turn it on, or we can disassemble it and solder some leads on it so it can be controlled by the Metro.

This wiring is for the first option (non-controlled laser).

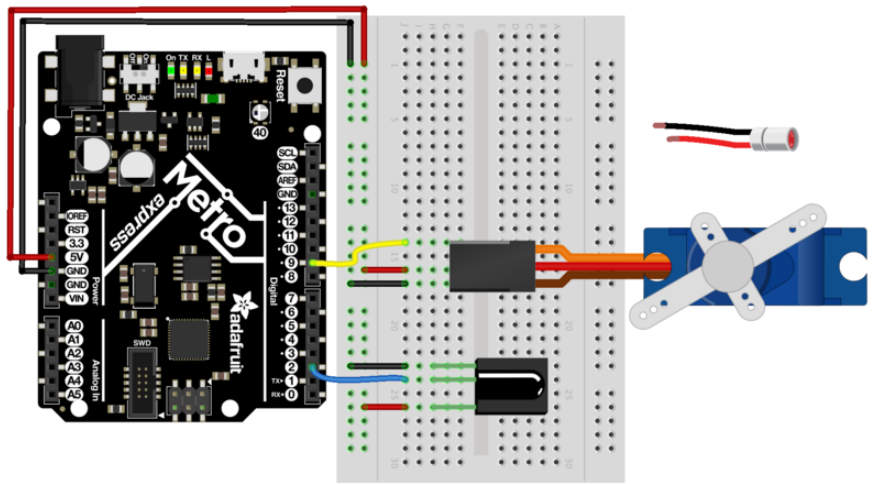

fritzing

This wiring is for the laser controlled by the IR Remote. We are controlling the laser by sending it a voltage from Pin #13.

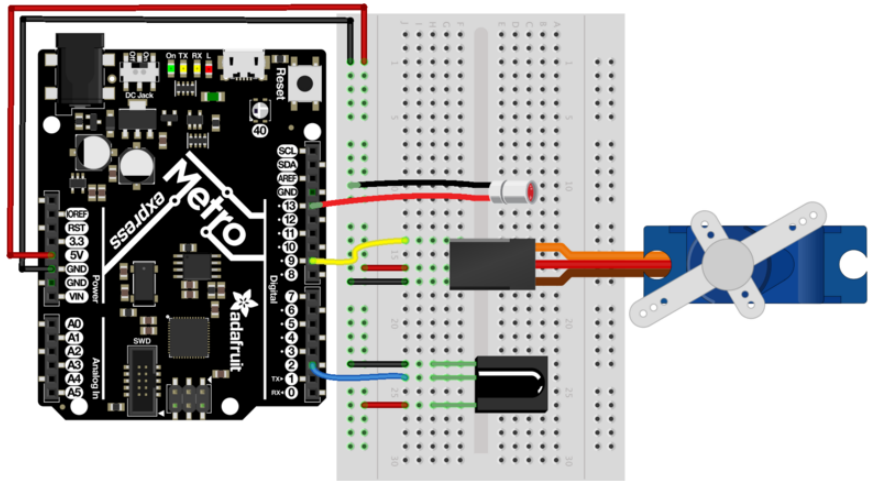

fritzing

Assembly

This project requires some assembly (like the music box) for you to get really good performance out of it.

Servo Wiring

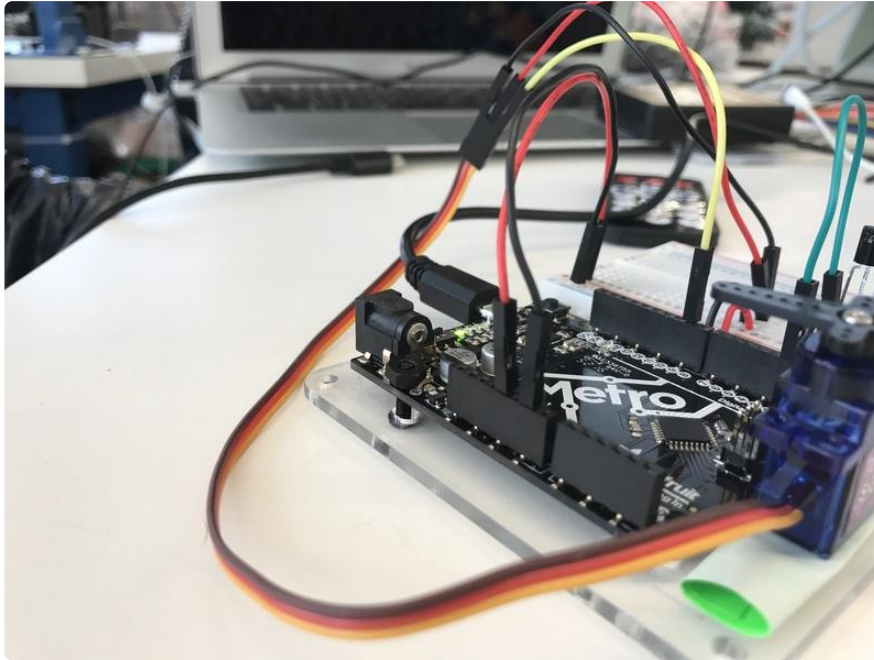

We are going to wire the servo such that the longer wires in your breadboard wiring bundle are used. We want to mount the Servo on

Base Assembly

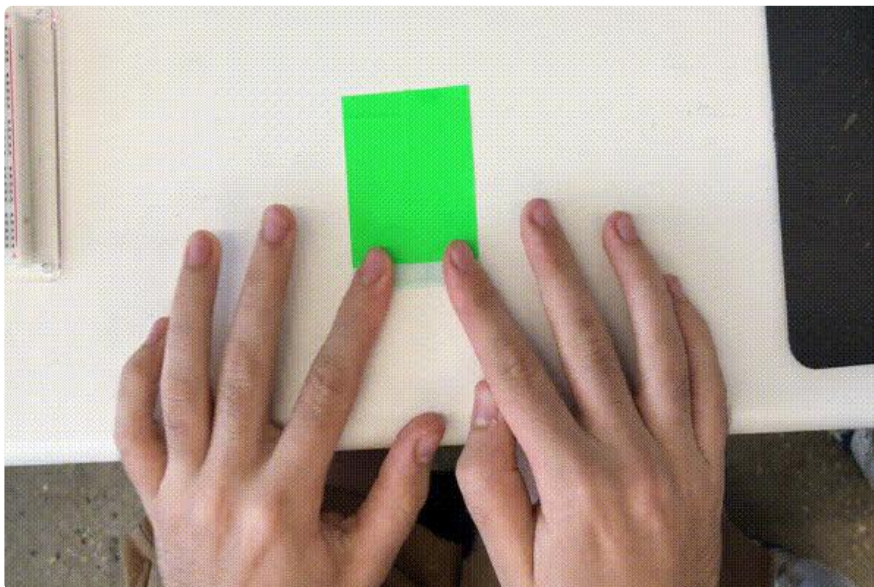

Take a piece of tape and fold it into itself (or roll it up).

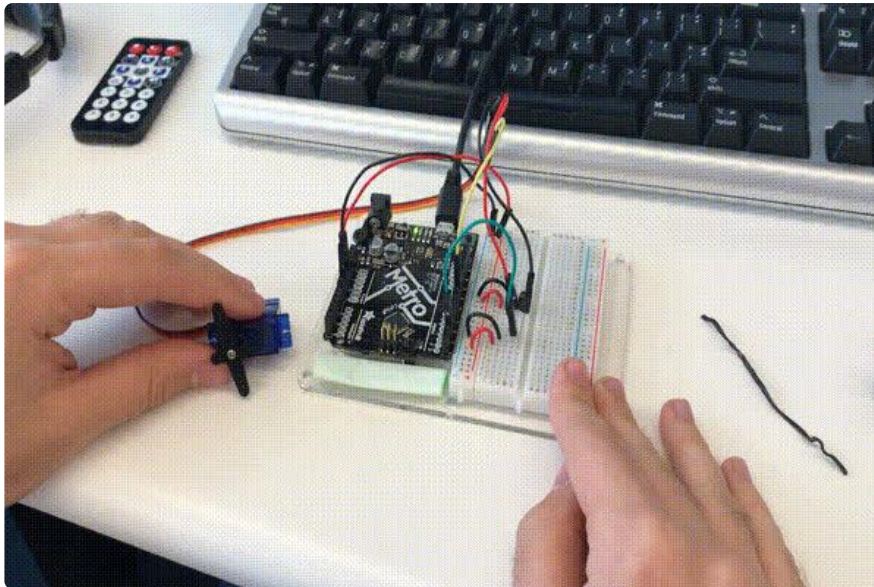

Then, place it on the mounting plate. Press down so it retains a firm grip (servos move really forcefully).

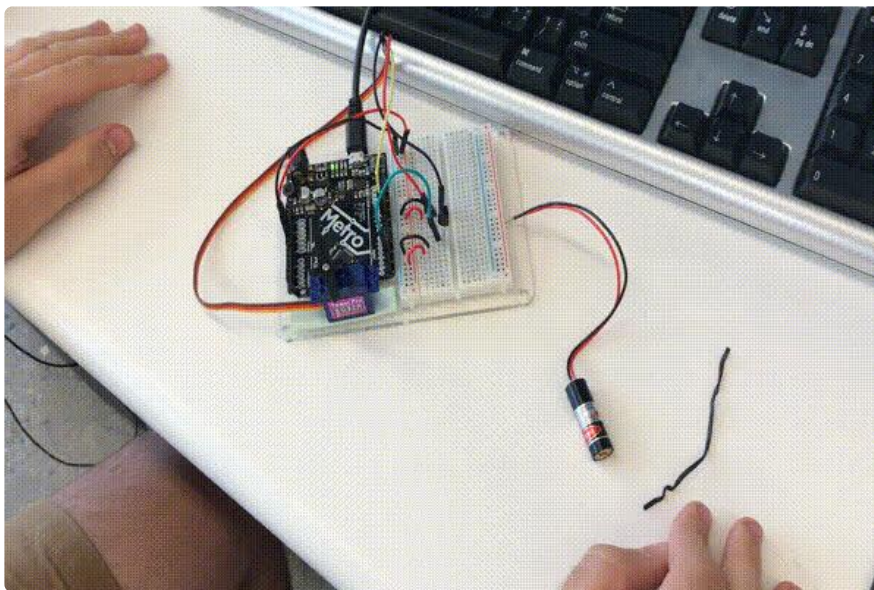

Take a twist-tie (like the ones you can get at your local supermarket) or a zip-tie and affix the Laser Pointer to the horn of the servo. We like using zip-ties and twist-ties because they're super inexpensive and non-permanent.

Code

The code for this is going to look very similar to PROJ05 - it uses a similar structure to handle IR remote button presses, but with the servo instead of USB HID. We are also going to introduce three new concepts that you might've seen in previous CIRCs - `random()`, `min()` and `max()`.

First, let's import both IRLib and Servo:

```
#include <IRLibAll.h>;
#include <Servo.h>;
```

Then, we are going to include all of the remote-specific code. This is going to include `#define`'s for remote values, the receiver pin assignment, the decoder object, and the ir protocol used.

```
/* Adafruit Mini Remote */
#define MY_PROTOCOL NEC
#define RIGHT_ARROW 0xfd50af
#define LEFT_ARROW 0xfd10ef
#define SELECT_BUTTON 0xfd906f
#define BUTTON_0 0xfd30cf
#define BUTTON_1 0xfd08f7
#define BUTTON_2 0xfd8877
#define BUTTON_3 0xfd48b7
#define BUTTON_4 0xfd28d7
#define BUTTON_5 0xfda857
#define BUTTON_6 0xfd6897
#define BUTTON_7 0xfd18e7
#define BUTTON_8 0xfd9867
#define BUTTON_9 0xfd58a7
// pin number for the receiver
IRrecv myReceiver(2);
IRdecode myDecoder;
// handles nec repeat codes
uint32_t Previous;
```

Next, we are going to create a servo object `myServo`, a variable to store the servo position and a variable to hold the angle (in degrees) of the servo.

```
/* Servo */
// create a servo object
Servo myServo;
// stores the servo position
int16_t pos;
// angle (degrees) to move the servo left/right
int16_t Speed;
```

(Optional) If you're using a laser and are able to control it from the metro (see: assembly), we are going to connect the power to pin 11. We are also going to make a boolean, `laserToggle`, to turn the laser on and off. `laserToggle` holds one of two values - true or false. Depending on the button pressed and the current state, we can easily toggle the laser.

```
/* Laser */
// connect laser PWR to a pin 11
const int laserPin = 11;
// toggle the laser
```



```
bool laserToggle = false;
```

Our `setup()` code needs to set the laser pin as an output, attach a servo to pin 9, set the initial `pos` to 90, the initial `pos` to 90 and the initial `Speed` to 5. Then, we are going to write `pos` to the servo and start the IR receiver.

```
void setup() {
  // randomizes a seed for random() calls
  randomSeed(analogRead(0));
  // set the laser pin as an output
  pinMode(laserPin, OUTPUT);
  // attach servo to pin 9
  myServo.attach(9);
  // set initial position
  pos = 90;
  // set initial speed
  Speed = 5;
  // write initial pos to servo at startup
  myServo.write(pos);
  // Start the IR receiver
  myReceiver.enableIRIn();
}
```

As previously mentioned, this code is similar to PROJ05:

The `loop()` is quite complicated, but we'll break it down to make it easier. We are going to first detect if the receiver gets an input from the remote with `myReceiver.getResults()`. Then, we are going to decode it with a call to `myDecoder.decode()`.

Next, we want to check if the protocol is the same as what's used by the Mini Remote, NEC, by checking `if(myDecoder.protocolNum==MY_PROTOCOL)`. Finally, we are going to detect the repeat codes, and set the current value to the previous decoded value `if(myDecoder.value==0xFFFFFFFF {myDecoder.value=Previous;}`

```
void loop()
{
  if (myReceiver.getResults()) {
    myDecoder.decode();
    if(myDecoder.protocolNum==MY_PROTOCOL) {
      if(myDecoder.value==0xFFFFFFFF)
        myDecoder.value=Previous;
      switch(myDecoder.value) {
```

This time, though, we are going to set the position of the servo before writing to it. Hobby servos are incredibly particular with how far they can rotate, and can break if you rotate them too far. Let's prevent this with the `min()` function. This function will set the position of the servo to `pos+Speed`, but it'll keep the value underneath or at 180 degrees so that it won't go past that point.

```
case LEFT_ARROW:
    // move servo
    pos=min(180,pos+Speed);
    break;
```

Similarly if we want to constrain the right side, we set `pos` to `max(0, pos-Speed)`. Max is the opposite of min, it constrains the lower-ends of the value.

```
case RIGHT_ARROW:
    pos=max(0,pos-Speed);
    break;
```

One of the cool things Arduino lets you do is generate [a random number. \(\)](#) We can generate a random number between 0 and 180 if we call `random(0, 180)`. Let's set one of the buttons to set the pos to call to random.

```
case BUTTON_0:
    pos=random(0,180);
    break;
```

After the case statements, you'll want to:

1. Write to the servo,
2. Handle the NEC repeat code: `Previous=myDecoder.value;`
3. Re-enable the IR Receiver

```
myServo.write(pos);
Previous=myDecoder.value;
myReceiver.enableIRIn();
```

The full code is below

```
/*
  Metro Explorers Guide
  PROJ06 - IR Laser Pet Toy
  by Brent Rubell and Asher Lieber for Adafruit Industries.  Support Open Source,
  buy Adafruit!

  Note: this sketch requires IRLIB2.x
*/
#include <IRLibAll.h>
#include <Servo.h>

/* Adafruit Mini Remote */
#define MY_PROTOCOL NEC
#define RIGHT_ARROW 0xfd50af
#define LEFT_ARROW 0xfd10ef
#define SELECT_BUTTON 0xfd906f
```

```

#define BUTTON_0 0xfd30cf
#define BUTTON_1 0xfd08f7
#define BUTTON_2 0xfd8877
#define BUTTON_3 0xfd48b7
#define BUTTON_4 0xfd28d7
#define BUTTON_5 0xfda857
#define BUTTON_6 0xfd6897
#define BUTTON_7 0xfd18e7
#define BUTTON_8 0xfd9867
#define BUTTON_9 0xfd58a7
// pin number for the receiver
IRrecv myReceiver(2);
IRdecode myDecoder;
// handles nec repeat codes
uint32_t Previous;

/* Servo */
// create a servo object
Servo myServo;
// stores the servo position
int16_t pos;
// angle (degrees) to move the servo left/right
int16_t Speed;

void setup() {
  // randomizes a seed for random() calls
  randomSeed(analogRead(0));
  // set the laser pin as an output
  //pinMode(laserPin, OUTPUT);
  // attach servo to pin 9
  myServo.attach(9);
  // set initial position
  pos = 90;
  // set initial speed
  Speed = 5;
  // write initial pos to servo at startup
  myServo.write(pos);
  // Start the IR receiver
  myReceiver.enableIRIn();
}

void loop()
{
  if (myReceiver.getResults()) {
    myDecoder.decode();
    if (myDecoder.protocolNum == MY_PROTOCOL) {
      if (myDecoder.value == 0xFFFFFFFF)
        myDecoder.value = Previous;
      switch (myDecoder.value) {
        case LEFT_ARROW:
          // move servo
          pos = min(180, pos + Speed);
          break;
        case RIGHT_ARROW:
          pos=max(0, pos-Speed);
          break;
        case BUTTON_0:
          pos=random(0,180);
          break;
      }
      // tell servo 'move to variable pos'
      myServo.write(pos);
      Previous=myDecoder.value;
    }
    myReceiver.enableIRIn();
  }
}

```

This project isn't working properly

My Servo doesn't properly move

Make sure your servo is attached to Digital Pin 9 on your Metro or Metro Express. Also make sure you have the servo library included in your sketch (at the top of your sketch, you should see `#include`).

I'm using a different remote, should I be doing something differently?

The code for this project only works with the Adafruit Mini Remote. [If you want to use another remote, please check this guide for more information.](#) ()

This project still isn't working

[Post up in the Adafruit Support Forums](#) and we will get back to you as soon as we can () :)

PROJ08: Analog Thermometer Gauge

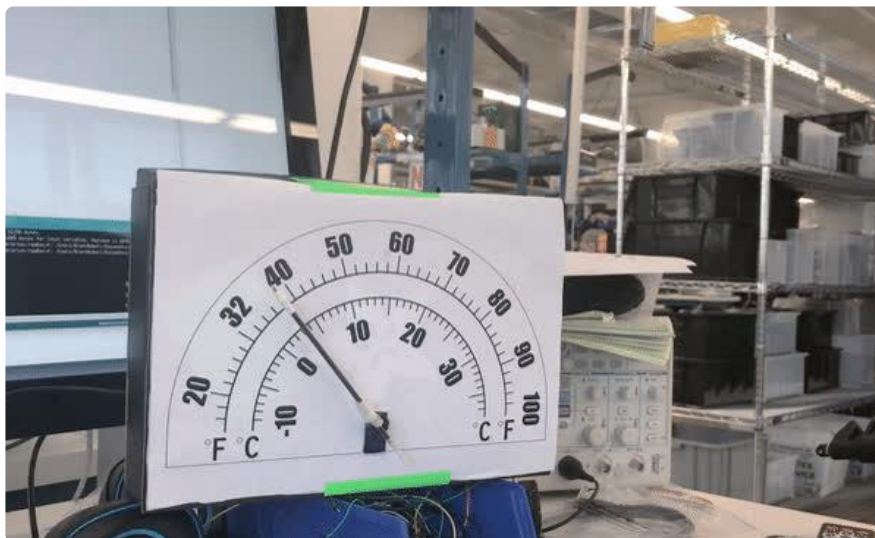

One of the cool products in the Adafruit Store is the [Automotive Gauge Stepper Motor](#) (), a stepper motor with a needle indicator attached to it. This gauge can be used for a physical-feel, similar to a tachometer on a car.

Since we already have a Servo motor, we can build an analog gauge to measure temperature. This PROJ can also be re-purposed to create a physical output gauge for anything you can measure!

Parts

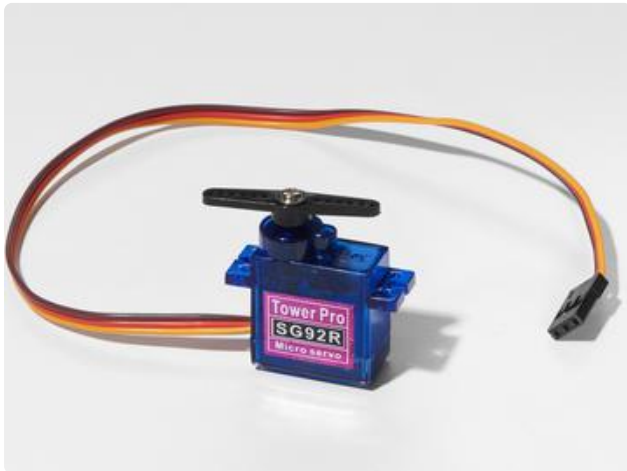

Mini Servo

If you'd like to order an extra mini servo from the Adafruit shop, [click here!](#) ()

There are many other servo sizes and types in the Adafruit store, check out our offerings ()

The Analog Temperature Sensor looks a LOT like the NPN Transistor, make sure it says "TMP36" on it!



Analog Temperature Sensor

If you'd like an extra temperature sensor, you can grab one from the Adafruit shop, [click here](#) ()

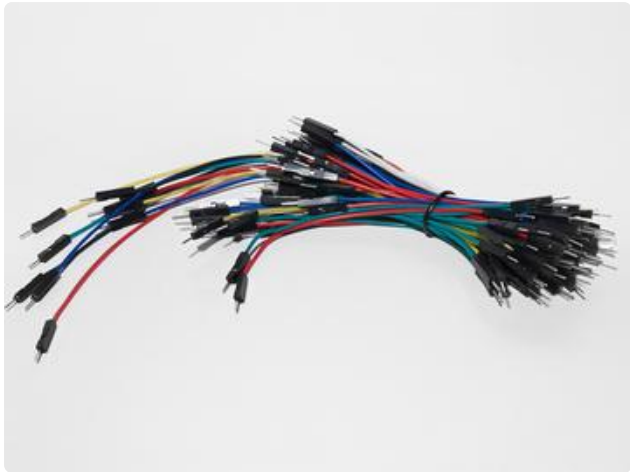

Breadboard Wiring Bundle

If you'd like to order more wires from the Adafruit shop click [here!](#) ()

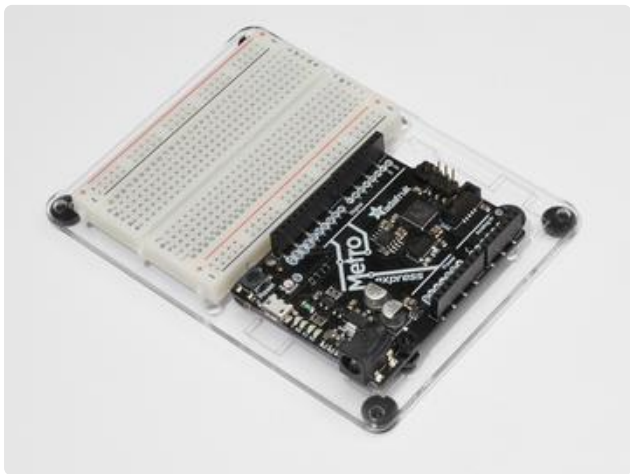

Adafruit Metro (or Metro Express) + Breadboard + Mounting Plate
If you have not assembled this, we have a [handy guide!](#) ()

If you'd like to order an extra plastic mounting plate (), Adafruit Metro (), Adafruit Metro Express (), or Mini-Breadboard () from the Adafruit Shop click [here!](#)

Wiring

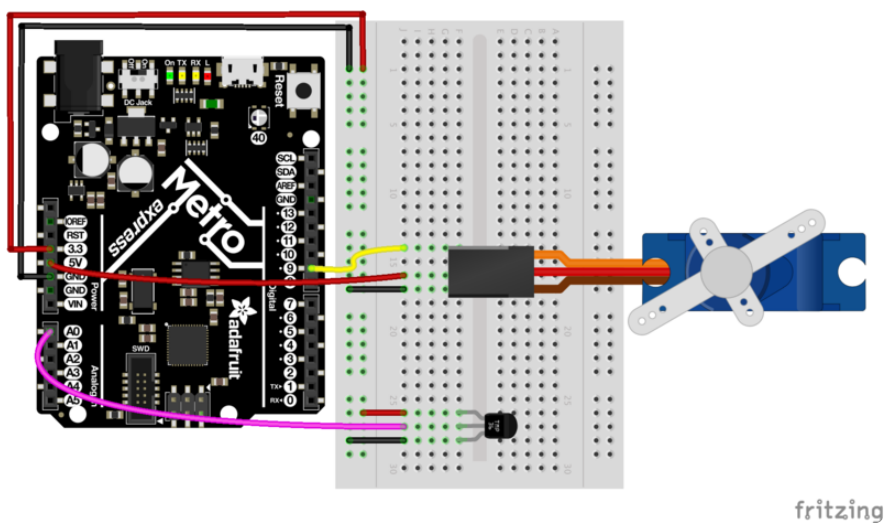

Note there are two power connections: the TMP36 is connected to 3.3V Pin and the S Ervo is connected to the 5V Pin. If you're using a regular metro, both can be connected to the 5V pin and controlled in code.

Assembly

Our assembly process for this can differ for how you want to make your circuit. The enclosure can be different, and you might even want to [try other servos from the Adafruit store \(\)](#). The calibration, though, is very important and you'll want to "dial in" your servo to make sure it's going to display perfectly.

Dialing in your Servo

First, we should move our servo to its center location. Download and run this small Arduino code. It'll move the servo to its center location:

```
/*
 * Servo Centering Script
 *
 */
#include <Servo.h>;

Servo myservo;

void setup() {
  myservo.attach(9);
}

void loop() {
  // change this depending on where you're centering
  myservo.write(90);
  delay(15);
}
```

You should see your servo horn move to the center. Take the horn off your servo (if you screwed it on, you'll have to unscrew it), and mark the tip of it with a marker. This will be your indicator:



Reattach the horn onto your servo (which should now be in the 90 degrees position) and you're ready to roll!



Assembling an enclosure

Let's build an enclosure so that you can use this on your desk at work, or somewhere in a room. The ever so talented [Dano Wall](#) ([@dano_wall](#)) whipped up a printable, cut-out, design which fits on top of the box that your metroX kit came in. It's a dual-dial design that works both with Fahrenheit and Celsius . You can download the design below (it's open-source and totally modifiable):

[Celsius_Fahrenheit_dial_A4_horizontal](#)

Test-fit the printed dial against your MetroX box, then cut it out along the outer black line

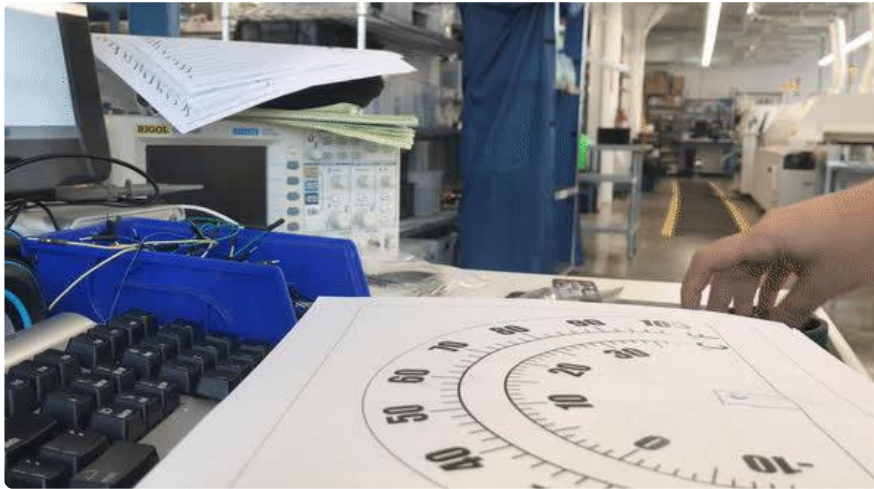

Tape the four corners (we only taped two in the gif below) of the paper to the inside of the box. Use transparent tape if you can, it'll look much cleaner:

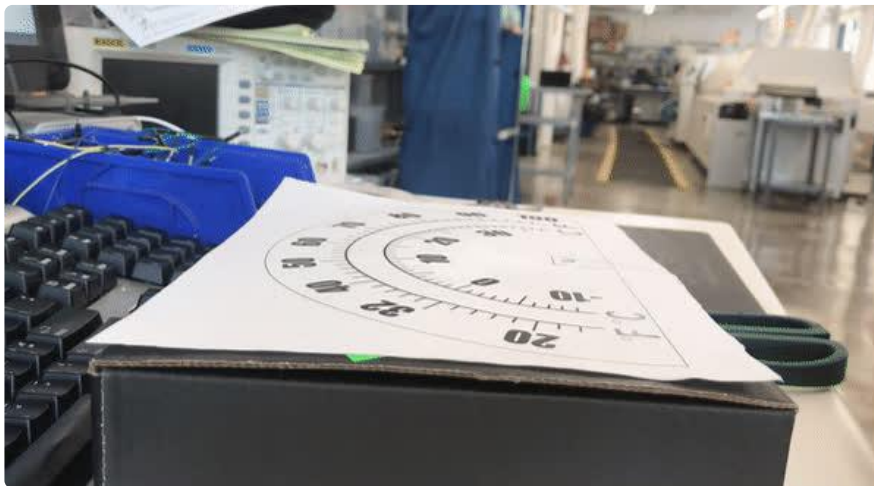

Use a box-cutter or the edge of a pair of scissors to cut out the servo cut-out (the rectangle) on your printed design. It might take a few cuts to get through the box completely:

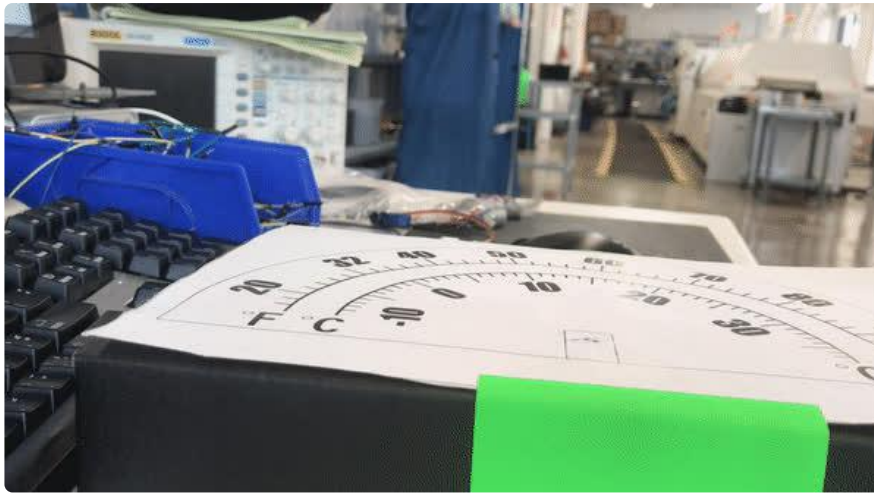

Clean up any residual cardboard from the hole you cut. Tape the servo in the rectangular hole, facing outward:



Finally, you'll need a pointing device. We used the inside of a disposable pen since they're inexpensive, and a lot of people have them lying around:



Great job! Close up the box and get ready to program:

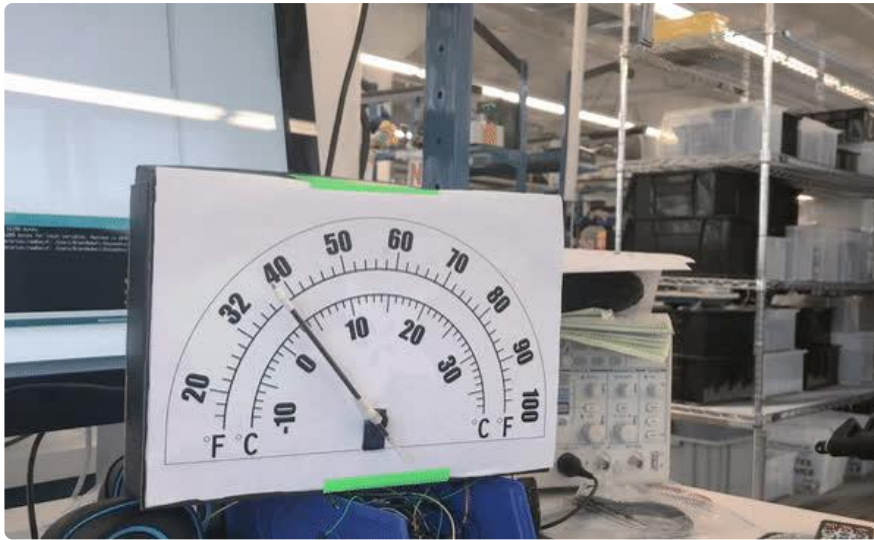

Code

The code for this is a mix between code for CIRC04: Servo and CIRC10: Temperature. What we're doing is attaching the value for the temperature, to a value of the servo. Let's walk through some parts of it:

Inside, the loop, we're going to read in a voltage from the pin using the `getVoltage()` function from CIRC04. We are then going to pass this value to a new function, `convertToF()`, which is generated from the voltage value, to convert the voltage to a degrees Fahrenheit temperature:

```
// read the voltage from the pin
float voltage = getVoltage(temperaturePin);
// convert the voltage to a temperature value
float temperature = convertToF(voltage);
```

Then, we're going to constrain the temperature values. This is totally up to you, you can use any number, but we are using -10F and 100F as our minimum and maximum temperature accepted by the TMP36:

```
map((int(temperature)), -10, 100
```

We still need to map the temperature values to servo values. The minimum degrees a servo can move is 0 degrees and the maximum degrees is 180, so let's set the servo to map: -10 to 0 and 100 to 180:

```
servoPos = map((int(temperature)), -10, 100, 0, 180);
```

Then, write `servoPos` to the servo!

```
// write servoPos to the servo
metroServo.write(servoPos);
// poll every 0.5sec
delay(500);
```

Here's the full code, with all the helpers built in:

Code

```
/*
 * PROJ07 - RGB Color Mixer
 *
 * by Brent Rubell for Adafruit Industries
 */

// RGB LED Pins
int rgbLED[] = {9, 10, 11};

// trim potentiometer pin
int trimPin = A0;
// button pin
const int buttonPin = 12;

// button state
int buttonState = 0;
// trim pot. value
int trimValue = 0;

int colorIdx = 0;
int red = 0;
int green = 0;
int blue = 0;

boolean CURRENTRGB[] = {0, 0, 0};

void setup() {
  // Setup Serial
  Serial.begin(9600);
  // set the 3 pins as output pins
  for(int i = 0; i < 3; i++) {
    pinMode(rgbLED[i], OUTPUT);
  }
  // initialize the push-button as an input
  pinMode(buttonPin, INPUT);
}

void loop() {
  // read the value of the push-button
  buttonState = digitalRead(buttonPin);

  if(buttonState == LOW) {
    delay(2);
    // reset the colorIdx if it goes past Blue (colorIdx = 3)
    if(colorIdx == 3) {
      colorIdx = 0;
    }
    colorIdx++;
    switch(colorIdx) {
      case 1:
        trimValue = analogRead(trimPin);
        red = map(trimValue, 0, 670, 0, 255);
```

```

    CURRENTRGB[0] = red;
    break;
case 2:
    trimValue = analogRead(trimPin);
    green = map(trimValue, 0, 670, 0, 255);
    CURRENTRGB[1] = green;
    break;
case 3:
    trimValue = analogRead(trimPin);
    blue = map(trimValue, 0, 670, 0, 255);
    CURRENTRGB[2] = blue;
    break;
default:
    break;
}

Serial.println("red:");
Serial.print(CURRENTRGB[0]);
Serial.println(" ");

Serial.println("green:");
Serial.print(CURRENTRGB[1]);
Serial.println(" ");

Serial.println("blue:");
Serial.print(CURRENTRGB[2]);
Serial.println(" ");

setColor(rgbLED, CURRENTRGB);
delay(1000);

}

}

void setColor(int* led, const boolean* color) {
    for(int i = 0; i < 3; i++){
        digitalWrite(led[i], color[i]);
    }
}
}

```

Code