

QSFP-100GB-130458-20-E-C

MSA and TAA 100GBase-OWDM QSFP28 Transceiver O-Band Channel OW304 400GHz (SMF, 1304.58nm, 20km, LC, DOM, -5 to +80C)

Features:

- Hot-pluggable QSFP28 form factor
- Compliant with QSFP28 MSA
- Supports 106.25Gb/s (PAM4)
- Duplex LC receptacles
- High Sensitivity APD Receiver
- OWDM 8 Wavelengths
- Single +3.3V power supply
- Aligned with IEEE 802.3bs and 100G Lambda MSA
- I2C management interface
- Operating temperature: -5 to +80 Celsius
- RoHS Compliant and Lead-Free



Applications:

- 100GBase Ethernet
- Access and Enterprise

Product Description

This MSA Compliant QSFP28 transceiver provides 100GBase-OWDM throughput up to 20km over single-mode fiber (SMF) using a wavelength of 1304.58nm via an LC connector. It is built to MSA standards and is uniquely serialized and data-traffic and application tested to ensure that they will integrate into your network seamlessly. Digital optical monitoring (DOM) support is also present to allow access to real-time operating parameters. This transceiver is Trade Agreements Act (TAA) compliant. We stand behind the quality of our products and proudly offer a limited lifetime warranty.

ProLabs's transceivers are RoHS compliant and lead-free.

TAA refers to the Trade Agreements Act (19 U.S.C. & 2501-2581), which is intended to foster fair and open international trade. TAA requires that the U.S. Government may acquire only "U.S. – made or designated country end products."



Regulatory Compliance

- ESD to the Electrical PINs: compatible with MIL-STD-883E Method 3015.4
- ESD to the LC Receptacle: compatible with IEC 61000-4-3
- EMI/EMC: compatible with FCC Part 15 Subpart B Rules, EN55022:2010
- Laser Eye Safety: compatible with FDA 21CFR, EN60950-1& EN (IEC) 60825-1,2
- RoHS compliant with EU RoHS 2.0 directive 2015/863/EU

Absolute Maximum Ratings

Parameter	Symbol	Min.	Max.	Unit
Maximum Supply Voltage	Vcc	0	3.6	V
Storage Temperature	TS	-40	85	°C
Operating Case Temperature	Tc	-5	80	°C
Relative Humidity (No Condensation)	RH	0	85	%
Damage Threshold	THd	0		dBm
Link Distance Through Mux	D		20	km
Link Distance Back-to-Back	D		40	km

Electrical Characteristics

Parameter	Symbol	Min.	Typ.	Max.	Unit	Notes
Supply Voltage	Vcc	3.135	3.3	3.465	V	
Supply Current	Icc			1.8	A	
Power Consumption			4.7 at -5°C 4.4 at 25°C 5.2 at 80°C	5.0 at -5°C 4.8 at 25°C 5.5 at 80°C	W	
Transmitter High-Speed Electrical Characteristics						
Signaling Rate	Rate	25.78125 ± 100ppm			Gbps	
Input Differential Impedance	ZIN		100		Ω	
Differential Input Voltage Per Lane				900	mV	
Input Impedance Mismatch				10	%	
Input High Voltage	VIH	2		Vcc+0.3	V	
Input Low Voltage	VIL	-0.3		0.8	V	
Receiver High-Speed Electrical Characteristics						
Signaling Rate	Rate	25.78125 ± 100ppm			Gbps	
Common-Mode Voltage	Vcm	-350		2850	mV	
Common-Mode Noise (RMS)				17.5	mV	20-80%

Differential Termination Resistance Mismatch (At 1MHz)				10	%	
Differential Return Loss (SDD22)				Per CEI-28G-VSR	dB	
Common-Mode to Differential Conversion and Differential to Common-Mode Conversion (SDC22, SCD22)				Per CEI-28G-VSR	dB	
Common-Mode Return Loss (SCC22): From 250MHz to 30GHz				-2		
Transition Time: 20-80%		9.5			ps	
Vertical Eye Closure	VEC			6.5	dB	
Eye Width at 10-15 Probability	EW15	0.57			UI	
Eye Height at 10-15 Probability	EH15	228			mV	

Optical Characteristics (EOL)

Parameter	Symbol	Min.	Typ.	Max.	Unit	Notes
Transmitter						
Data Rate Per Lane		53.125 ± 100ppm			Gbps	
Modulation Format		PAM4				
Wavelength	λ	1304.18	1304.58	1304.98	nm	
Side-Mode Suppression Ratio	SMSR	30			dB	
Average Launch Power	Pavg	0		3.4	dBm	1
Outer Optical Modulation Amplitude (OMA _{outer})	TDP<1.4dB	POMA	3.0		6.4	dBm
	TDP>1.4dB		1.6+TDP		6.4	dBm
Transmitter and Dispersion Penalty	TDP			3.4	dB	
TECQ	TECQ			3.9	dB	
TDP-TECQ (Maximum)				2.5	dB	
Extinction Ratio	ER	5.0			dB	
Optical Return Loss Tolerance	ORLT			15.6	dB	
Transmitter Reflectance	RL			-26	dB	2
Average Launch Power Off Transmitter	Poff			-15	dBm	
RIN _{15.6 OMA}	RIN			-136	dB/Hz	
Receiver						
Data Rate Per Lane		53.125 ± 100ppm			Gbps	
Modulation Format		PAM				
Lane Wavelength	λ	1295.04~1311.96			nm	
Damage Threshold	THd	0			dBm	3
Average Receive Power		-15.7		-3	dBm	4
Receive Power (OMA _{outer})				-2.6	dBm	
Receiver Reflectance	RL			-26	dB	
Receiver Sensitivity (OMA _{outer})					dBm	5, 6
Stressed Receiver Sensitivity (OMA _{outer}) Per Lane - Maximum	SRS			-11.6	dBm	
Transmitter Reflectance	RL			-26	dB	
LOS Assert	LOSA	-30		-19.5	dBm	
LOS De-Assert	LOSD			-16.5	dBm	
LOS Hysteresis	LOSH	0.5			dB	
Conditions of Stress Receiver Sensitivity Test						
Stressed Eye Closure for PAM4 (SECQ) Lane Under Test				3.4	dB	
SECQ – 10*log ₁₀ (Ceq) Lane Under Test				3.4	dB	

Notes:

1. Average launch power (minimum) is informative and not the principal indicator of signal strength. A transmitter with launch power below this value cannot be compliant; however, a value above this does not ensure compliance.
2. Transmitter Reflectance is defined looking into the transmitter.
3. The receiver shall be able to tolerate, without damage, continuous exposure to a modulated optical input signal having this power level on one lane.
4. Average receive power (minimum) is informative and not the principal indicator of signal strength. A received power below this value cannot be compliant; however, a value above this does not ensure compliance.
5. Receiver Sensitivity (OMA_{outer}) (maximum) is informative and is defined for a transmitter with a value of SECQ up to 3.4dB for 100G ER1 O-Band WDM.
6. Measured with a conformance test signal at TP3 (see 3.11) for the BER specified in IEEE Std 802.3.

Pin Descriptions

Pin	Symbol	Name/Descriptions	Ref.
1	GND	Transmitter Ground (Common with Receiver Ground).	1
2	Tx2-	Transmitter Inverted Data Input.	
3	Tx2+	Transmitter Non-Inverted Data Output.	
4	GND	Transmitter Ground (Common with Receiver Ground).	1
5	Tx4-	Transmitter Inverted Data Input.	
6	Tx4+	Transmitter Non-Inverted Data Output.	
7	GND	Transmitter Ground (Common with Receiver Ground).	1
8	ModSelL	Module Select.	2
9	ResetL	Module Reset.	2
10	VccRx	+3.3V Power Supply Receiver.	
11	SCL	2-Wire Serial Interface Clock.	2
12	SDA	2-Wire Serial Interface Data.	2
13	GND	Transmitter Ground (Common with Receiver Ground).	1
14	Rx3+	Receiver Non-Inverted Data Output.	
15	Rx3-	Receiver Inverted Data Output.	
16	GND	Transmitter Ground (Common with Receiver Ground).	1
17	Rx1+	Receiver Non-Inverted Data Output.	
18	Rx1-	Receiver Inverted Data Output.	
19	GND	Transmitter Ground (Common with Receiver Ground).	1
20	GND	Transmitter Ground (Common with Receiver Ground).	1
21	Rx2-	Receiver Inverted Data Output.	
22	Rx2+	Receiver Non-Inverted Data Output.	
23	GND	Transmitter Ground (Common with Receiver Ground).	1
24	Rx4-	Receiver Inverted Data Output.	1
25	Rx4+	Receiver Non-Inverted Data Output.	
26	GND	Transmitter Ground (Common with Receiver Ground).	1
27	ModPrsl	Module Present.	
28	IntL	Interrupt.	2
29	VccTx	+3.3V Power Supply Transmitter.	
30	Vcc1	+3.3V Power Supply.	
31	LPMODE	Low-Power Mode.	2
32	GND	Transmitter Ground (Common with Receiver Ground).	1
33	Tx3+	Transmitter Non-Inverted Data Input.	
34	Tx3-	Transmitter Inverted Data Output.	

Recommended Host Board Power Supply Filter Network

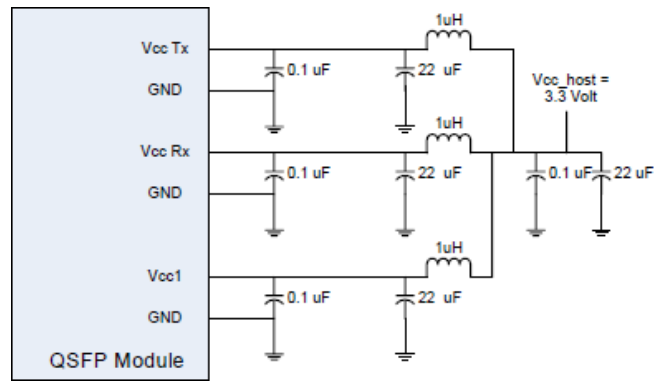

Block Diagram

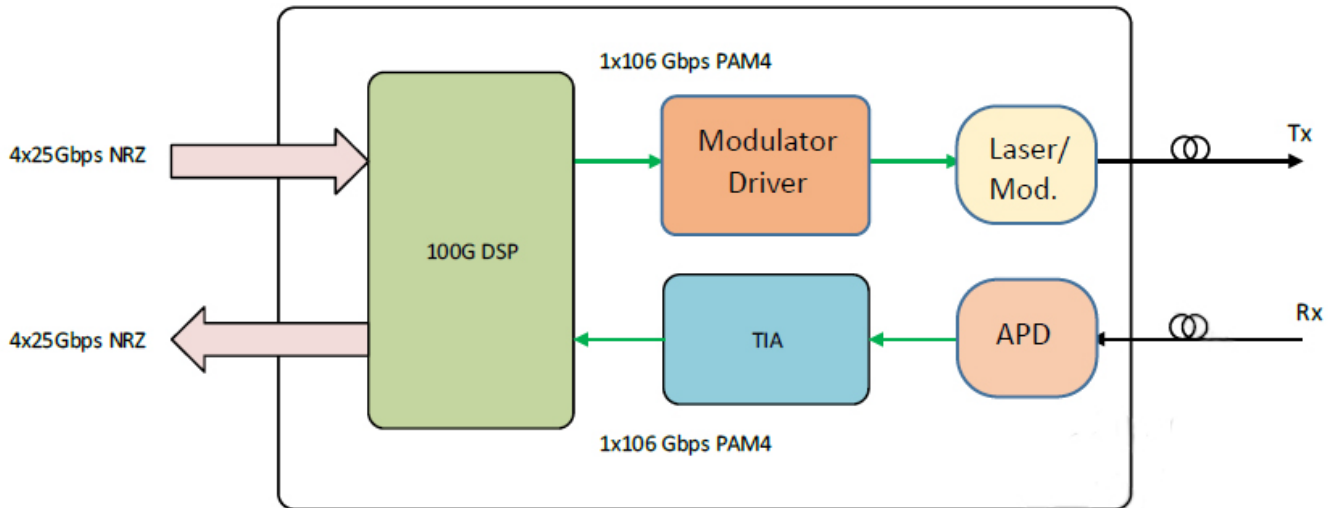

Mechanical Specifications

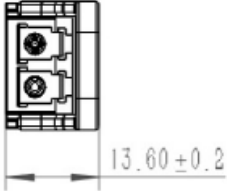
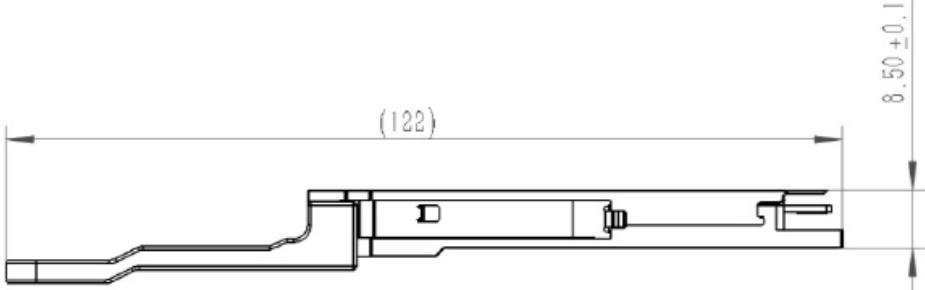
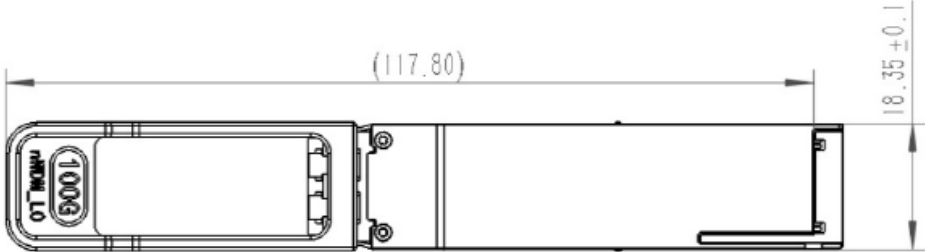

About ProLabs

Our experience comes as standard; for over 15 years ProLabs has delivered optical connectivity solutions that give our customers freedom and choice through our ability to provide seamless interoperability. At the heart of our company is the ability to provide state-of-the-art optical transport and connectivity solutions that are compatible with over 90 optical switching and transport platforms.

Complete Portfolio of Network Solutions

ProLabs is focused on innovations in optical transport and connectivity. The combination of our knowledge of optics and networking equipment enables ProLabs to be your single source for optical transport and connectivity solutions from 100Mb to 400G while providing innovative solutions that increase network efficiency. We provide the optical connectivity expertise that is compatible with and enhances your switching and transport equipment.

Trusted Partner

Customer service is our number one value. ProLabs has invested in people, labs and manufacturing capacity to ensure that you get immediate answers to your questions and compatible product when needed. With Engineering and Manufacturing offices in the U.K. and U.S. augmented by field offices throughout the U.S., U.K. and Asia, ProLabs is able to be our customers best advocate 24 hours a day.

Contact Information

ProLabs US

Email: sales@prolabs.com

Telephone: 952-852-0252

ProLabs UK

Email: salessupport@prolabs.com

Telephone: +44 1285 719 600