

CCT	DIM A	DIM B	DIM C	TOL
2	5.00	10.20	12.30	+/-0.30
3	10.00	15.20	17.30	
4	15.00	20.20	22.30	
5	20.00	25.20	27.30	
6	25.00	30.20	32.30	
7	30.00	35.20	37.30	
8	35.00	40.20	42.30	
9	40.00	45.20	47.30	
10	45.00	50.20	52.30	
11	50.00	55.20	57.30	
12	55.00	60.20	62.30	

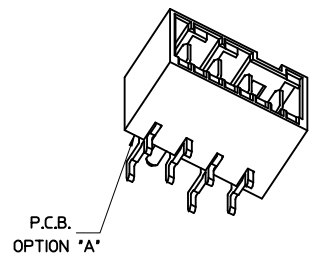

HOLES ON SOME TOOLED VERSIONS

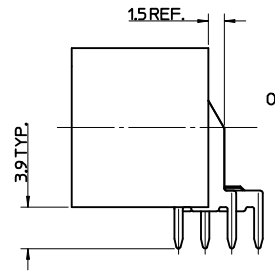
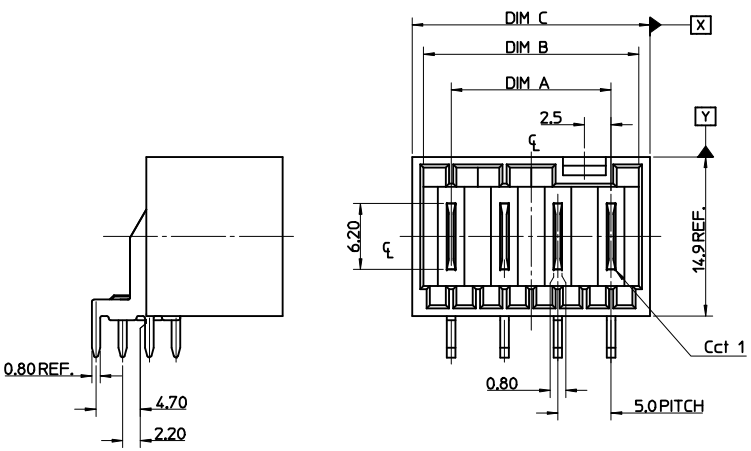
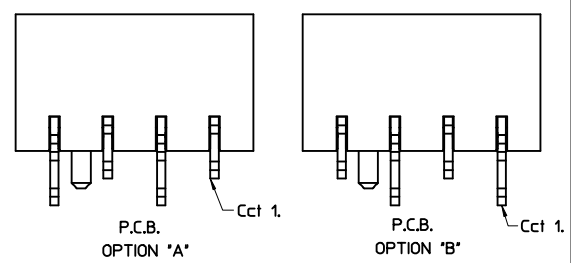
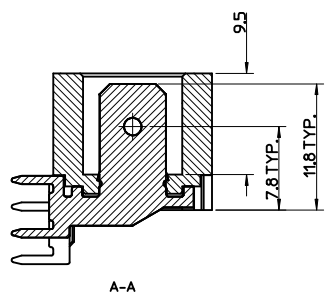
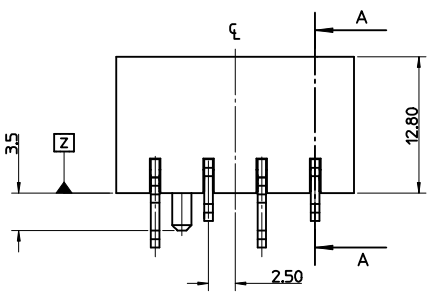
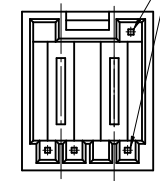

RECOMMENDED PCB LAYOUT

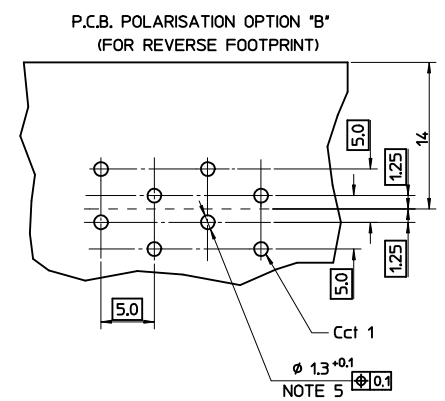
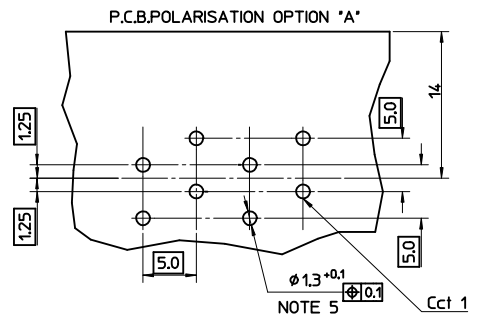

- NOTES:
- MATERIAL:
HOUSING: 30% GLASS-FILLED PBT, UL94 V-0
TERMINAL: BRASS 0.80REF. THICK
PLATING: OPTIONAL (SEE CHARTS SHEETS 2-7)
TIN PLATING OPTION : 34m TIN OVER 1.274m NICKEL ALL AREAS.
SELECTIVE SILVER
CONTACT AREA : 24m SILVER OVER 1.274m NICKEL, ALL OTHER AREAS FLASH OF SILVER 0.104m
 - PRODUCT CONFORMS TO SPECIFICATION PS-99020-0037
 - MATES WITH MOLEX 91338, 90833, 90835, 91777, 91778 & 91779
 - PARTS PACKED IN TRAYS OPTION C SEE PK-90858-001 FOR PACKAGING INFORMATION
 - PLATED THRU HOLE
 - RECOMMENDED PCB THICKNESS: 15 mm REF
 - PCB VIEW IS FROM SOLDER SIDE

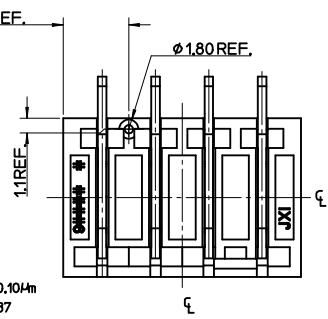

REV	DESCRIPTION	QUALITY SYMBOLS	GENERAL TOLERANCES (UNLESS SPECIFIED)		DIMENSION STYLE	SCALE	DESIGN UNITS	THIRD ANGLE PROJECTION	
			mm	INCH	MM ONLY	1:1	METRIC	⊙	
CHANGED NOTE 6	EC NO: IFC2017-0179	▽=0	4 PLACES	± ---	DRAWN BY	DATE	TITLE		
DRW:ZCRAMER	2016/08/16	▽=0	3 PLACES	± ---	NMCNAMAR	2004/05/22	RAST 5 R.A. HDR		
CHKD:			2 PLACES	± 0.1	CHECKED BY	DATE			
APPR:BRUTTE	2016/08/30		1 PLACE	± 0.2	JDENNEHY	2004/05/23			
			0 PLACE	±	APPROVED BY	DATE			
			ANGULAR ± 2 °		BMAGUIRE	2004/05/27			
			DRAFT WHERE APPLICABLE MUST REMAIN WITHIN DIMENSIONS		MATERIAL NO.	DOCUMENT NO.			
			SEE SHEETS 2-7		SD-90879-001		SHEET NO. 1 OF 7		
			THIS DRAWING CONTAINS INFORMATION THAT IS PROPRIETARY TO MOLEX INCORPORATED AND SHOULD NOT BE USED WITHOUT WRITTEN PERMISSION						

2 CIRCUIT

PART NO. (TIN)	TERM NO. (TIN)	HOUSING NO.	COLOUR	UNBLOCKED POSITION KEYS	UNBLOCKED CODING KEYS	LATCH POSITION	CONFIGURATION (SEE NOTES)	LUNBERG K REF	TERM NO. (SILVER)	PART NO. (SILVER)	P.C.B. POLARISATION OPTION	SEE CODE DESIGNATION TABLE FOR NUMBERING FORMAT WHEN ADDING NEW PART NUMBERS
90879-0003	91703-0005/8	91704-0002	NATURAL	1b 2a	01c d20	1/2		K01	91703-0006/9	90879-0499	A	
90879-0046	91703-0005/8	91704-0003	NATURAL	1a 2b	01c	1/2		K02	91703-0006/9	90879-0498	A	
90879-0026	91703-0005/8	91704-0004	NATURAL	1b 2b	01c	1/2		K09	91703-0006/9	90879-0488	A	
90879-0018	91703-0005/8	91704-0005	NATURAL	2a	01c, d20	1/2		K03	91703-0006/9	90879-0495	A	
90879-0021	91703-0005/8	91704-0006	NATURAL	1b	01c, d20	1/2		K16	91703-0006/9	90879-0492	A	
90879-0022	91703-0005/8	91704-0007	NATURAL	1a 2b	NONE	1/2		K06	91703-0006/9	90879-0491	A	
90879-0019	91703-0005/8	91704-0008	NATURAL	1a 2b	d20	1/2		K05	91703-0006/9	90879-0478	A	
90879-0058	91703-0005/8	91704-0009	NATURAL	2b	NONE	1/2		K11	91703-0006/9	90879-0476	A	
90879-0029	91703-0005/8	91704-0010	NATURAL	1a 1b	d20	1/2		K13	91703-0006/9	90879-0486	A	
90879-0030	91703-0005/8	91704-0011	NATURAL	2a 2b	NONE	1/2		K31	91703-0006/9	90879-0485	A	
90879-0059	91703-0005/8	91704-0012	NATURAL	2b	d20	1/2		K38	91703-0006/9	90879-0475	A	
90879-0060	91703-0005/8	91704-0013	NATURAL	1a 2a	01c d20	1/2		K44	91703-0006/9	90879-0474	A	
90879-0061	91703-0005/8	91704-0014	NATURAL	1a 1b	NONE	1/2		K40	91703-0006/9	90879-0473	A	
90879-0020	91703-0005/8	91704-0015	NATURAL	1a 1b	01c	1/2		K04	91703-0006/9	90879-0493	A	
90879-0062	91703-0005/8	91704-0016	NATURAL	2b	01c d20	1/2		K15	91703-0006/9	90879-0472	A	
90879-0057	91703-0005/8	91704-0017	NATURAL	1a	01c d20	1/2		K12	91703-0006/9	90879-0477	A	
90879-0009	91703-0005/8	91704-0018	NATURAL	1a 2a	01c	1/2		K10	91703-0006/9	90879-0496	A	
90879-0049	91703-0005/8	91704-0019	NATURAL	ALL	d20	1/2		K34	91703-0006/9	90879-0481	A	
90879-0056	91703-0005/8	91704-0020	NATURAL	1b 2a 2b	d20	1/2		K07	91703-0006/9	90879-0479	A	
90879-0063	91703-0005/8	91704-0002	NATURAL	1b 2a	01c d20	1/2		K01	91703-0006/9	90879-0471	B	
90879-0064	91703-0005/8	91704-0021	NATURAL	2a	01c	1/2		K42	91703-0006/9	90879-0470	A	

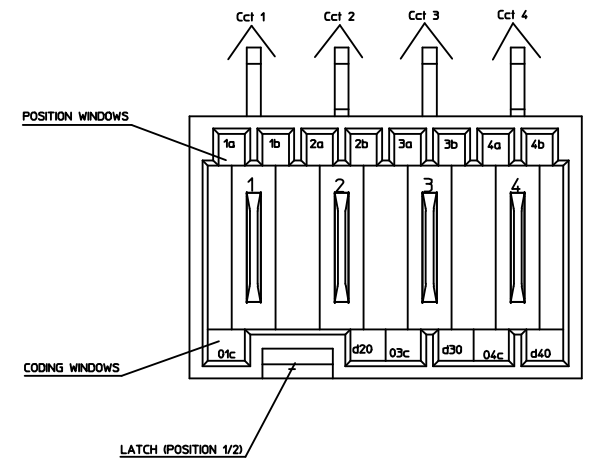

KEYING, CODING & LATCH POSITION
(4CCT EXAMPLE SHOWN)
VIEW INMATING DIRECTION

SEE SHEET 1 EC NO: PG2017-0179 D: DRWINZGRANER 2016/08/16 CHKD: APPR: BRUTILE 2016/08/30 REV:	QUALITY SYMBOLS	GENERAL TOLERANCES (UNLESS SPECIFIED)	DIMENSION STYLE	SCALE	DESIGN UNITS	THIRD ANGLE PROJECTION
	$\nabla=0$ $\nabla=0$	mm INCH 4 PLACES ± --- ± --- 3 PLACES ± --- ± --- 2 PLACES ± 0.1 ± --- 1 PLACE ± 0.2 ± --- 0 PLACE ± ±	MM ONLY	1:1	METRIC	
		ANGULAR ± 2 ° DRAFT WHERE APPLICABLE MUST REMAIN WITHIN DIMENSIONS	DRAWN BY DATE NMCNAR 2004/05/22 CHECKED BY DATE JDENNEHY 2004/05/23 APPROVED BY DATE BMAGUIRE 2004/05/27	TITLE	RAST 5 R.A. HDR	
		SEE CHARTS THIS DRAWING CONTAINS INFORMATION THAT IS PROPRIETARY TO MOLEX INCORPORATED AND SHOULD NOT BE USED WITHOUT WRITTEN PERMISSION	MATERIAL NO.	DOCUMENT NO.	SD-90879-001	
						SHEET NO. 2 OF 7

3 CIRCUIT											P.C.B. POLARISATION OPTION
SEE CODE DESIGNATION TABLE FOR NUMBERING FORMAT WHEN ADDING NEW PART NUMBERS											
PART NO. (TIN)	TERM NO. (TIN)	MOLEX HOUSING NO	COLOUR	UNBLOCKED POSITION KEYS	UNBLOCKED CODING KEYS	LATCH POSITION	CONFIGURATION (SEE NOTES)	LUMBERG K REF	TERM NO. (SILVER)	PART NO. (SILVER)	
90879-0502	91703-0005/8	91704-1000	NATURAL	1b	01c, d20	1/2		K01	91703-0006/9	90879-1249	A
90879-0508	91703-0005/8	91704-1001	NATURAL	1a	03c	1/2		K04	91703-0006/9	90879-1248	A
90879-0528	91703-0005/8	91704-1002	NATURAL	1a 1b	d30	1/2		K05	91703-0006/9	90879-1247	A
90879-0512	91703-0005/8	91704-1003	NATURAL	1a 3b	01c	1/2		K06	91703-0006/9	90879-1246	A
90879-0519	91703-0005/8	91704-1004	NATURAL	1b	d20 03c	1/2		K09	91703-0006/9	90879-1245	A
90879-0529	91703-0005/8	91704-1005	NATURAL	1b 2a 2b	d30	1/2		K33	91703-0006/9	90879-1244	A
90879-0530	91703-0005/8	91704-1006	NATURAL	2b	d20	1/2		K56	91703-0006/9	90879-1243	A
90879-0526	91703-0005/8	91704-1007	NATURAL	ALL	d10 d30	2/3		K38	91703-0006/9	90879-1242	A
90879-0527	91703-0005/8	91704-1008	NATURAL	ALL	d20	1/2		K40	91703-0006/9	90879-1241	A
90879-0531	91703-0005/8	91704-1014	NATURAL	2b, 3a	d10, d30	2/3		K---	91703-0006/9	90879-1240	A
90879-0532	91703-0005/8	91704-1015	NATURAL	2b, 3b	d10, 02c	2/3		K---	91703-0006/9	90879-1239	A
90879-0533	91703-0005/8	91704-1000	NATURAL	1b	01c, d20	1/2		K01	91703-0006/9	90879-1238	B
90879-0534	91703-0005/8	91704-1016	NATURAL	1b, 2a, 2b, 3b	NONE	2/3		K---	91703-0006/9	90879-1237	B

4 CIRCUIT											P.C.B. POLARISATION OPTION
SEE CODE DESIGNATION TABLE FOR NUMBERING FORMAT WHEN ADDING NEW PART NUMBERS											
PART NO. (TIN)	TERM NO. (TIN)	MOLEX HOUSING NO.	COLOUR	UNBLOCKED POSITION KEYS	UNBLOCKED CODING KEYS	LATCH POSITION	CONFIGURATION (SEE NOTES)	LUMBERG K REF	TERM NO. (SILVER)	PART NO. (SILVER)	
90879-1254	91703-0005/8	91704-2000	NATURAL	1b	03c d40	1/2 3/4		K01	91703-0006/9	90879-1999	A
90879-1264	91703-0005/8	91704-2001	NATURAL	1a 4b	d40	1/2 3/4		K03	91703-0006/9	90879-1997	A
90879-1265	91703-0005/8	91704-2002	NATURAL	2a 4b	d20	1/2 3/4		K07	91703-0006/9	90879-1996	A
90879-1267	91703-0005/8	91704-2003	NATURAL	1b 2a 3a 4b	01c d40	1/2 3/4		K37	91703-0006/9	90879-1994	A
90879-1278	91703-0005/8	91704-2004	NATURAL	1a 2b 4b	01c 03c d40	1/2 3/4		K44	91703-0006/9	90879-1988	A
90879-1279	91703-0005/8	91704-2005	NATURAL	1a 3a 3b	01c d20 d40	1/2 3/4		K32	91703-0006/9	90879-1987	A
90879-1280	91703-0005/8	91704-2006	NATURAL	1b 2a 4b	01c d20 03c	1/2 3/4		K61	91703-0006/9	90879-1986	A
90879-1281	91703-0005/8	91704-2007	NATURAL	1a 3a	d40	1/2 3/4		K06	91703-0006/9	90879-1985	A
90879-1282	91703-0005/8	91704-2008	NATURAL	1a 2b 3b 4a	01c 03c d40	1/2 3/4		K65	91703-0006/9	90879-1984	A
90879-1266	91703-0005/8	91704-2009	NATURAL	2a 4b	d20 03c	1/2 3/4		K30	91703-0006/9	90879-1995	A
90879-1276	91703-0005/8	91704-2010	NATURAL	3b	d30	2/3		K04	91703-0006/9	90879-1989	A
90879-1283	91703-0005/8	91704-2014	NATURAL	1b, 2a, 3a, 4b	d20, d04	1/2 3/4		K109	91703-0006/9	90879-1983	A
90879-1284	91703-0005/8	91704-2015	NATURAL	ALL	03c d04	1/2 3/4		K**	91703-0006/9	90879-1982	A

SEE SHEET 1 EEC NO: 1P02017-0179 DRAWN BY: DRWINZCRAWER CHYKD: APPR:BRUTILE REV:	QUALITY SYMBOLS DESCRIPTION: 2016/08/30	GENERAL TOLERANCES (UNLESS SPECIFIED)		DIMENSION STYLE MM ONLY		SCALE 1:1	DESIGN UNITS METRIC	THIRD ANGLE PROJECTION		
		4 PLACES ± --- ± ---	3 PLACES ± --- ± ---	2 PLACES ± 0.1 ± ---	1 PLACE ± 0.2 ± ---	0 PLACE ± ±	DRAWN BY: NMCNAMAR DATE: 2004/05/22	CHECKED BY: JDENNEHY DATE: 2004/05/23	APPROVED BY: BMAGUIRE DATE: 2004/05/27	TITLE RAST 5 R.A. HDR
		ANGULAR ± 2 °		DRAFT WHERE APPLICABLE MUST REMAIN WITHIN DIMENSIONS		SEE CHARTS		MATERIAL NO.		DOCUMENT NO. SD-90879-001
		THIS DRAWING CONTAINS INFORMATION THAT IS PROPRIETARY TO MOLEX INCORPORATED AND SHOULD NOT BE USED WITHOUT WRITTEN PERMISSION								SHEET NO. 3 OF 7

5 CIRCUIT

SEE CODE DESIGNATION TABLE FOR NUMBERING
FORMAT WHEN ADDING NEW PART NUMBERS

PART NO. (TIN)	TERM NO. (TIN)	MOLEX HOUSING NO.	COLOUR	UNBLOCKED POSITION KEYS	LATCH POSITION	CONFIGURATION (SEE NOTES)	LUMBERG K REF	TERM NO. (SILVER)	PART NO. (SILVER)	P.C.B. POLARISATION OPTION
90879-2000	91703-0005/8	91704-3000	NATURAL	1a 5b	1/2 2/3		K01	91703-0006/9	90879-2749	A
90879-2001	91703-0005/8	91704-3001	NATURAL	1a 3a	1/2 4/5		K30	91703-0006/9	90879-2748	A
90879-2002	91703-0005/8	91704-3002	NATURAL	1a 5b	1/2 3/4		K31	91703-0006/9	90879-2747	A
90879-2003	91703-0005/8	91704-3003	NATURAL	1b 2a 3b 5a	1/2 3/4		K35	91703-0006/9	90879-2746	A
90879-2023	91703-0005/8	91704-3004	NATURAL	1a 2a 2b 4b 5b	1/2 2/3 4/5		K36	91703-0006/9	90879-2732	A
90879-2024	91703-0005/8	91704-3005	NATURAL	2a	2/3 4/5		K43	91703-0006/9	90879-2731	A
90879-2025	91703-0005/8	91704-3006	NATURAL	2a 4b	1/2 3/4		K44	91703-0006/9	90879-2730	A
90879-2026	91703-0005/8	91704-3007	NATURAL	2b	1/2 4/5		K02	91703-0006/9	90879-2729	A
90879-2027	91703-0005/8	91704-3008	NATURAL	4b 5a	1/2 4/5		K45	91703-0006/9	90879-2728	A
90879-2028	91703-0005/8	91704-3009	NATURAL	NONE	1/2 3/4		K46	91703-0006/9	90879-2727	A
90879-2029	91703-0005/8	91704-3010	NATURAL	1a 4b	1/2 4/5		K04	91703-0006/9	90879-2726	A
90879-2030	91703-0005/8	91704-3011	NATURAL	1a 5b	1/2 3/4		K77	91703-0006/9	90879-2725	A
90879-2005	91703-0005/8	91704-3012	NATURAL	1b 2b 4a	1/2 4/5		K40	91703-0006/9	90879-2744	A
90879-2016	91703-0005/8	91407-3013	NATURAL	3b 4a 5b	2/3 4/5		K47	91703-0006/9	90879-2738	A
90879-2018	91703-0005/8	91704-3014	NATURAL	1a 4b	1/2 3/4		K48	91703-0006/9	90879-2736	A
90879-2020	91703-0005/8	91704-3015	NATURAL	1a 5b	2/3		K50	91703-0006/9	90879-2734	A
90879-2021	91703-0005/8	91704-3016	NATURAL	1b 2a 4a	1/2 4/5		K51	91703-0006/9	90879-2733	A
90879-2022	91703-0005/8	91704-3017	NATURAL	2b 3b 4a	1/2 3/4		K52	91703-0006/9	90879-2735	A

6 CIRCUIT

SEE CODE DESIGNATION TABLE FOR NUMBERING
FORMAT WHEN ADDING NEW PART NUMBERS

PART NO. (TIN)	TERM NO. (TIN)	MOLEX HOUSING NO.	COLOUR	UNBLOCKED POSITION KEYS	UNBLOCKED CODING KEYS	LATCH POSITION	CONFIGURATION (SEE NOTES)	LUMBERG K REF	TERM NO. (SILVER)	PART NO. (SILVER)	P.C.B. POLARISATION OPTION
90879-2753	91703-0005/8	91704-4000	NATURAL	1b	03c d60	1/2 4/5		K01	91703-0006/9	90879-3499	A
90879-2754	91703-0005/8	91704-4001	NATURAL	1a 3b 4b	01c d50 06c	1/2 4/5		K30	91703-0006/9	90879-3498	A
90879-2755	91703-0005/8	91704-4002	NATURAL	1a 1b 2b 3a 3b 4b	d30 04c d50	1/2 2/3 4/5		K37	91703-0006/9	90879-3497	A
90879-2756	91703-0005/8	91704-4003	NATURAL	1a 1b 4a 4b	d10 d50	2/3 4/5		K39	91703-0006/9	90879-3496	A
90879-2757	91703-0005/8	91704-4004	NATURAL	2a 4b 5a 6b	d20 03c 05c	1/2 3/4 5/6		K42	91703-0006/9	90879-3495	A
90879-2758	91703-0005/8	91704-4005	NATURAL	1a 2b 3a 3b 5b 6b	01c d40 d60	1/2 3/4 5/6		K43	91703-0006/9	90879-3494	A
90879-2759	91703-0005/8	91704-4006	NATURAL	1b 2a 3a 4b 5a 5b 6b	01c 03c d60	1/2 3/4 5/6		K44	91703-0006/9	90879-3493	A
90879-2760	91703-0005/8	91704-4007	NATURAL	2b	d20 d60	1/2 5/6		K46	91703-0006/9	90879-3492	A
90879-2761	91703-0005/8	91704-4008	NATURAL	2b 3b 4a	01c d50 06c	1/2 4/5		K36	91703-0006/9	90879-3491	A
90879-2762	91703-0005/8	91704-4009	NATURAL	1b 4b	d20 03c d50 06c	1/2 4/5		K58	91703-0006/9	90879-3486	A
90879-2764	91703-0005/8	91704-4010	NATURAL	1a 2b 3b 4a 6b	01c 03c d40 05c d60	1/2 3/4 5/6		K59	91703-0006/9	90879-3485	A
90879-2765	91703-0005/8	91704-4011	NATURAL	1a 2b 4a 6b	01c d40	1/2 3/4 5/6		K62	91703-0006/9	90879-3484	A
90879-2763	91703-0005/8	91704-4012	NATURAL	1b 2b 3b	01c 05c d60	1/2 3/4 5/6		K51	91703-0006/9	90879-3490	A
90879-2766	91703-0005/8	91704-4013	NATURAL	1b	d20 03c	1/2 4/5		K55	91703-0006/9	90879-3489	A
90879-2767	91703-0005/8	91704-4014	NATURAL	1b 2a 3a 5a 5b	01c d20 03c d40 d60	1/2 3/4 5/6		K56	91703-0006/9	90879-3488	A
90879-2771	91703-0005/8	91704-4015	NATURAL	1a 3a 3b 5b 6a	01c d20 240 05c d60	1/2 3/4 5/6		K60	91703-0006/9	90879-3487	A

SEE SHEET 1 EC NO: IPG2017-0079 D: DRWINGZGRNER 2016/08/16 CHKD: APPR:BRUTILE 2016/08/30 REV:	QUALITY SYMBOLS ▽=0 ▽=0	GENERAL TOLERANCES (UNLESS SPECIFIED) <table border="1"> <tr><th></th><th>mm</th><th>INCH</th></tr> <tr><td>4 PLACES</td><td>± .005</td><td>± .0004</td></tr> <tr><td>3 PLACES</td><td>± .008</td><td>± .0003</td></tr> <tr><td>2 PLACES</td><td>± .010</td><td>± .0002</td></tr> <tr><td>1 PLACE</td><td>± .015</td><td>± .0001</td></tr> <tr><td>0 PLACE</td><td>± .020</td><td>± .0000</td></tr> </table>		mm	INCH	4 PLACES	± .005	± .0004	3 PLACES	± .008	± .0003	2 PLACES	± .010	± .0002	1 PLACE	± .015	± .0001	0 PLACE	± .020	± .0000	DIMENSION STYLE MM ONLY	SCALE 1:1	DESIGN UNITS METRIC	THIRD ANGLE PROJECTION
		mm	INCH																					
	4 PLACES	± .005	± .0004																					
	3 PLACES	± .008	± .0003																					
2 PLACES	± .010	± .0002																						
1 PLACE	± .015	± .0001																						
0 PLACE	± .020	± .0000																						
DRAWN BY NMCNAMAR 2004/05/22	CHECKED BY JDENNEHY 2004/05/23	APPROVED BY BMAGUIRE 2004/05/27	MATERIAL NO.	TITLE RAST 5 R.A. HDR	DOCUMENT NO. SD-90879-001	SHEET NO. 4 OF 7																		
DRAFT WHERE APPLICABLE MUST REMAIN WITHIN DIMENSIONS	SEE CHARTS	THIS DRAWING CONTAINS INFORMATION THAT IS PROPRIETARY TO MOLEX INCORPORATED AND SHOULD NOT BE USED WITHOUT WRITTEN PERMISSION																						

7 CIRCUIT

SEE CODE DESIGNATION TABLE FOR NUMBERING FORMAT WHEN ADDING NEW PART NUMBERS											P.C.B. POLARISATION OPTION
PART NO. (TIN)	TERM NO. (TIN)	MOLEX HOUSING NO.	COLOR	UNLOCKED POSITION KEYS	UNLOCKED CODING KEYS	LATCH POSITION	CONFIGURATION (SEE NOTES)	LUMBERG K REF	TERM NO. (SILVER)	PART NO. (SILVER)	P.C.B. POLARISATION OPTION
90879-3500	91703-0005/8	91704-5000	NATURAL	NONE	03c d40 07c	1/2 5/6		K01	91703-0006/9	90879-4220	A
90879-3512	91703-0005/8	91704-5001	NATURAL	3a 4a	d30 d70	1/2 5/6		K30	91703-0006/9	90879-4248	A
90879-3504	91703-0005/8	91704-5002	NATURAL	2b	d20 d60	1/2 5/6		K32	91703-0006/9	90879-4247	A
90879-3513	91703-0005/8	91704-5003	NATURAL	1a 1b 3a 4b 5a	01c 07c	1/2 3/4 5/6		K40	91703-0006/9	90879-4240	A
90879-3514	91703-0005/8	91704-5004	NATURAL	2a	01c d50	2/3 4/5		K41	91703-0006/9	90879-4239	A
90879-3515	91703-0005/8	91704-5005	NATURAL	7b	01c d40 d70	1/2 3/4 6/7		K43	91703-0006/9	90879-4238	A
90879-3516	91703-0005/8	91704-5006	NATURAL	1b	03c d60	1/2 4/5		K31	91703-0006/9	90879-4237	A
90879-3517	91703-0005/8	91704-5007	NATURAL	1a 3a 4b 7b	01c d20 03c 06c	1/2 3/4 6/7		K45	91703-0006/9	90879-4236	A
90879-3518	91703-0005/8	91704-5008	NATURAL	1b 7a	02c d50	2/3 6/7		K48	91703-0006/9	90879-4235	A
90879-3519	91703-0005/8	91704-5009	NATURAL	1a 2b 3a 4b 6a	d20 03c d40 d50 d70	1/2 3/4 6/7		K51	91703-0006/9	90879-4234	A
90879-3520	91703-0005/8	91704-5010	NATURAL	1b 6a	d20 03c d50 d70	1/2 3/4 6/7		K69	91703-0006/9	90879-4233	A
90879-3505	91703-0005/8	91704-5011	NATURAL	1b 2a 5a 5b 7b	d20 d50 06c d70	1/2 4/5 6/7		K34	91703-0006/9	90879-4246	A
90879-3506	91703-0005/8	91704-5012	NATURAL	2b	d20 07c	1/2 3/4 5/6		K35	91703-0006/9	90879-4245	A
90879-3507	91703-0005/8	91704-5013	NATURAL	2a 2b 4b 5b 6a	d20 03c d40 d60	1/2 3/4 5/6		K38	91703-0006/9	90879-4244	A
90879-3510	91703-0005/8	91704-5014	NATURAL	2b 4a 4b 5b 6a	01c d20 d40 d60	1/2 3/4 5/6		K42	91703-0006/9	90879-4241	A

8 CIRCUIT

SEE CODE DESIGNATION TABLE FOR NUMBERING FORMAT WHEN ADDING NEW PART NUMBERS											P.C.B. POLARISATION OPTION
PART NO. (TIN)	TERM NO. (TIN)	MOLEX HOUSING NO.	COLOR	UNLOCKED POSITION KEYS	UNLOCKED CODING KEYS	LATCH POSITION	CONFIGURATION (SEE NOTES)	LUMBERG K REF	TERM NO. (SILVER)	PART NO. (SILVER)	P.C.B. POLARISATION OPTION
90879-4252	91703-0005/8	91704-6000	NATURAL	4a 6b	03c d60	1/2 3/4 5/6 7/8		K30	91703-0006/9	90879-4998	A
90879-4253	91703-0005/8	91704-6001	NATURAL	1a 2a 3a 3b 6a 7a 7b 8b	01c 05c d60	1/2 3/4 5/6 7/8		K33	91703-0006/9	90879-4997	A
90879-4254	91703-0005/8	91704-6002	NATURAL	2b 3b 4b 5a 5b 7a 8b	01c d60 d80	1/2 4/5 7/8		K41	91703-0006/9	90879-4996	A
90879-4255	91703-0005/8	91704-6003	NATURAL	1b 4b 7b 8b	01c d20 04c d50 07c	1/2 4/5 7/8		K45	91703-0006/9	90879-4995	A
90879-4256	91703-0005/8	91704-6004	NATURAL	1a 1b 3b 5a 6b 7a 8b	01c 03c d40 d60	1/2 3/4 5/6 7/8		K46	91703-0006/9	90879-4993	A
90879-4257	91703-0005/8	91704-6005	NATURAL	1b 5a 6b 8a	03c d40 05c 07c d80	1/2 3/4 5/6 7/8		K48	91703-0006/9	90879-4995	A
90879-4259	91703-0005/8	91704-6006	NATURAL	8b	02c d30 07c	2/3 7/8			91703-0006/9	90879-4996	A
90879-4258	91703-0005/8	91704-6007	NATURAL	1a 4b 5b 6a 8b	d40 d60 07c d80	1/2 3/4 5/6 7/8		K44	91703-0006/9	90879-4994	A
90879-4263	91703-0005/8	91704-6008	NATURAL	8b	02c d30	2/3		K49	91703-0006/9	90879-4990	A

SEE SHEET 1 EC NO: IP0207-079 DRAWN BY: DRWINZORNER CHKD: APPR:BRUTILE 2016/08/16 2016/08/30	QUALITY SYMBOLS 	GENERAL TOLERANCES (UNLESS SPECIFIED) m/m INCH 4 PLACES ± --- ± --- 3 PLACES ± --- ± --- 2 PLACES ± 0.1 ± --- 1 PLACE ± 0.2 ± --- 0 PLACE ± ±	DIMENSION STYLE MM ONLY	SCALE 1:1	DESIGN UNITS METRIC	THIRD ANGLE PROJECTION
	DRAWN BY: NMCNAMAR CHECKED BY: JDENNEHY APPROVED BY: BMAGUIRE DATE: 2004/05/22 DATE: 2004/05/23 DATE: 2004/05/27	TITLE RAST 5 R.A. HDR	MATERIAL NO. SEE CHARTS	DOCUMENT NO. SD-90879-001	SHEET NO. 5 OF 7	
	DRAFT WHERE APPLICABLE MUST REMAIN WITHIN DIMENSIONS					
	THIS DRAWING CONTAINS INFORMATION THAT IS PROPRIETARY TO MOLEX INCORPORATED AND SHOULD NOT BE USED WITHOUT WRITTEN PERMISSION					

9 CIRCUIT

SEE CODE DESIGNATION TABLE FOR NUMBERING FORMAT WHEN ADDING NEW PART NUMBERS										P.C.B. POLARISATION OPTION	
PART NO. (TIN)	TERM NO. (TIN)	MOLEX HOUSING NO.	COLOUR	UNBLOCKED POSITION KEYS	UNBLOCKED CODING KEYS	LATCH POSITION	CONFIGURATION (SEE NOTES)	LUMBERG K REF	TERM NO. (SILVER)		PART NO. (SILVER)
90879-5002	91703-0005/8	91704-7000	NATURAL	1a 2a 2b 3a 3b 6a 7a 8b 9b	d20 03c d40 d50 d90	1/2 3/4 6/7 7/8 8/9		K30	91703-0006/9	90879-5997	A
90879-5003	91703-0005/8	91704-7001	NATURAL	1b 2a 3b 5a 6a 7b 8a 8b	01c 03c d70 08c	1/2 3/4 6/7 8/9		K31	91703-0006/9	90879-5996	A
90879-5004	91703-0005/8	91704-7002	NATURAL	1b 2a 3a 5a 6a 7b 8b	01c 03c d70 08c	1/2 3/4 6/7 8/9		K32	91703-0006/9	90879-5995	A
90879-5005	91703-0005/8	91704-7003	NATURAL	1a 1b 3a 4b 5a 6b 7a	01c d40 09c	1/2 3/4 5/6 7/8		K37	91703-0006/9	90879-5994	A
90879-5006	91703-0005/8	91704-7004	NATURAL	1b 5a 8a 9a	03c d40 d60 08c	1/2 3/4 5/6 8/9		K38	91703-0006/9	90879-5993	A
90879-5007	91703-0005/8	91704-7005	NATURAL	2a 4b 5a 6b 6b 7a 9a	d20 05c 07c	1/2 3/4 5/6 7/8		K39	91703-0006/9	90879-5992	A
90879-5009	91703-0005/8	91704-7006	NATURAL	5b	d30 d70	1/2 6/7		K04	91703-0006/9	90879-5998	A
90879-5008	91703-0005/8	91704-7007	NATURAL	2b 3b 4a 5a 6b	d10 02c 04c 08c d90	2/3 4/5 6/7 8/9		K40	91703-0006/9	90879-5991	A
90879-5010	91703-0005/8	91704-7008	NATURAL	2b 5a	d80	2/3 7/8		K03	91703-0006/9	90879-5990	A

10 CIRCUIT

SEE CODE DESIGNATION TABLE FOR NUMBERING FORMAT WHEN ADDING NEW PART NUMBERS										P.C.B. POLARISATION OPTION
PART NO. (TIN)	TERM NO. (TIN)	MOLEX HOUSING NO.	COLOUR	UNBLOCKED POSITION KEYS	LATCH POSITION	CONFIGURATION (SEE NOTES)	LUMBERG K REF	TERM NO. (SILVER)	PART NO. (SILVER)	
90879-6002	91703-0005/8	91704-8000	NATURAL	2a 3b 6a 9a	1/2 4/5 6/7 9/10		K30	91703-0006/9	90879-6997	A
90879-6003	91703-0005/8	91704-8001	NATURAL	1a 3b 7b 9b	1/2 3/4 5/6 7/8 9/10		K35	91703-0006/9	90879-6996	A
90879-6005	91703-0005/8	91704-8002	NATURAL	1b 2a 2b 4a 5b 6a 8a 9a 10a	1/2 4/5 6/7 9/10		K41	91703-0006/9	90879-6993	A
90879-6006	91703-0005/8	91704-8003	NATURAL	1a 3b 4b 8a 10a 10b	1/2 4/5 7/8 9/10		K42	91703-0006/9	90879-6992	A
90879-6007	91703-0005/8	91704-8004	NATURAL	2a 4b 8a 10a	1/2 3/4 5/6 8/9		K44	91703-0006/9	90879-6991	A
90879-6008	91703-0005/8	91704-8005	NATURAL	1b 2a 3a 4b 5b 9a	1/2 3/4 5/6 7/8 9/10		K48	91703-0006/9	90879-6990	A
90879-6009	91703-0005/8	91704-8006	NATURAL	1a 4b 6b 9a	1/2 4/5 6/7 8/9		K38	91703-0006/9	90879-6989	A
90879-6010	91703-0005/8	91704-8007	NATURAL	1a 3b 7b 8a	1/2 3/4 5/6 7/8 9/10		K33	91703-0006/9	90879-6988	A
90879-6012	91703-0005/8	91704-8008	NATURAL	10a	1/2 9/10		K56	91703-0006/9	90879-6987	A
90879-6004	91703-0005/8	91704-8009	NATURAL	1b 3b 5b 9a	1/2 3/4 5/6 7/8 9/10		K36	91703-0006/9	90879-6995	A
90879-6011	91703-0005/8	91704-8010	NATURAL	1b 2b 4a 7a 9a 9b	1/2 4/5 6/7 9/10		K43	91703-0006/9	90879-6999	A
90879-6013	91703-0005/8	91704-8011	NATURAL	1a 2a 2b 3a 4a 4b 5a 6a 6b 7a 8a 8b 9a 10a 10b	1/2 3/4 5/6 7/8 9/10		K45	91703-0006/9	90879-6985	A
90879-6014	91703-0005/8	91704-8012	NATURAL	2a 2b 3a 4a 5a 9a 10a	1/2 3/4 5/6 8/9		K46	91703-0006/9	90879-6984	A
90879-6017	91703-0005/8	91704-8013	NATURAL	1b 2a 3a 4b 6a 7a 8a 8b	1/2 3/4 5/6 9/10		K49	91703-0006/9	90879-6981	A
90879-6018	91703-0005/8	91704-8014	NATURAL	1b 5a 8b 9a 10b	1/2 3/4 5/6 7/8 9/10		K50	91703-0006/9	90879-6980	A
90879-6019	91703-0005/8	91704-8015	NATURAL	1b 3a 4a 4b 6b 9a 9b	1/2 4/5 6/7 9/10		K51	91703-0006/9	90879-6979	A
90879-6020	91703-0005/8	91704-8016	NATURAL	1b 4a 7a 9a	1/2 4/5 7/8 9/10		K52	91703-0006/9	90879-6978	A

SEE SHEET 1 EC NO: IPZ017-079 DRAWING: GRAMER 2016/08/16 CHKD: APPR: BRUTTE 2016/08/30 REV:	QUALITY SYMBOLS ▽=0 ▽=0	GENERAL TOLERANCES (UNLESS SPECIFIED) mm INCH 4 PLACES ± --- ± --- 3 PLACES ± --- ± --- 2 PLACES ± 0.1 ± --- 1 PLACE ± 0.2 ± --- 0 PLACE ± ±	DIMENSION STYLE MM ONLY	SCALE 1:1	DESIGN UNITS METRIC	THIRD ANGLE PROJECTION
	DRAWN BY NMCNAMAR 2004/05/22	CHECKED BY JDENNEHY 2004/05/23	APPROVED BY BMAGUIRE 2004/05/27	MATERIAL NO. SEE CHARTS	DOCUMENT NO. SD-90879-001	SHEET NO. 6 OF 7
	DRAFT WHERE APPLICABLE MUST REMAIN WITHIN DIMENSIONS					
	THIS DRAWING CONTAINS INFORMATION THAT IS PROPRIETARY TO MOLEX INCORPORATED AND SHOULD NOT BE USED WITHOUT WRITTEN PERMISSION					

11 CIRCUIT

SEE CODE DESIGNATION TABLE FOR NUMBERING FORMAT WHEN ADDING NEW PART NUMBERS										P.C.B. POLARISATION OPTION	
PART NO. (TRN)	TERM NO. (TRN)	MOLEX HOUSING NO.	COLOR	UNBLOCKED POSITION KEYS	UNBLOCKED CODING KEYS	LATCH POSITION	CONFIGURATION (SEE NOTES)	LUMBERG K REF	TERM NO. (SILVER)	PART NO. (SILVER)	P.C.B. POLARISATION OPTION
90879-7001	91703-0005/8	91704-9000	NATURAL	1a 2b 3c 4a 4b 5a 7a 8a 9a 10a 11a	01c d40 05c 08c 011c	3/4 8/9		K33	91703-0006/9	90879-7999	A
90879-7002	91703-0005/8	91704-9001	NATURAL	1a 1b 6b 7a 10a 11b	03c d40 d90	1/2 3/4 5/6 7/8 8/9 10/11		K30	91703-0006/9	90879-7997	A
90879-7003	91703-0005/8	91704-9002	NATURAL	1a 2b 3c 4a 4b 5a 7a 8a 9a 10a 11a	01c d40 05c 08c 011c	1/2 3/4 5/6 8/9 10/11		K31	91703-0006/9	90879-7998	A
90879-7004	91703-0005/8	91704-9003	NATURAL	2a 3b 4a 4b 5a 6b7a 7b 10a 11b	d40 07c d90 010c	1/2 3/4 5/6 7/8 10/11		K32	91703-0006/9	90879-7996	A
90879-7005	91703-0005/8	91704-9004	NATURAL	2a 3b 4a 4b 6a 6b 8b 10a 11a	01c d20 d40 06c 08c d90 010c	1/2 3/4 6/7 8/9 10/11		K34	91703-0006/9	90879-7995	A
90879-7007	91703-0005/8	91704-9005	NATURAL	2a 4b 5b 7b 8a 11b	d10 d30 d50 d80 010c d110	2/3 4/5 7/8 10/11		K36	91703-0006/9	90879-7994	A
90879-7008	91703-0005/8	91704-9006	NATURAL	1b 3a 4b 6a 7b 9b	01c d20 d40 05c d60 07c d90 09c d100	1/2 3/4 5/6 7/8 9/10		K37	91703-0006/9	90879-7992	A
90879-7009	91703-0005/8	91704-9007	NATURAL	2a 6a 8a 11b	01c d50 d90 d110	2/3 4/5 6/7 8/9 10/11		K38	91703-0006/9	90879-7991	A
90879-7010	91703-0005/8	91704-9008	NATURAL	1a 4a 6a 8a 11b	d30 d90 d110	1/2 4/5 6/7 8/9 10/11		K39	91703-0006/9	90879-7990	A
90879-7013	91703-0005/8	91704-9009	NATURAL	1a 1b 2b 4a 5a 8b 9b	02c d80 09c d100	2/3 5/6 7/8 9/10		K46	91703-0006/9	90879-7989	A
90879-7014	91703-0005/8	91704-9010	NATURAL	1b 5b 6b 8b 9b 10a 10b	01c d20 d40 05c d70 08c 010c	1/2 5/6 8/9 10/11		K47	91703-0006/9	90879-7986	A
90879-7015	91703-0005/8	91704-9011	NATURAL	1a 2b 3b 5a 6b 8a 9b	d30 03c 06c 09c d100	1/2 3/4 6/7 9/10		K44	91703-0006/9	90879-7985	A
90879-7016	91703-0005/8	91704-9012	NATURAL	1b 4a 7b 9b 10b	01c d20 04c d80 011c d110	1/2 4/5 6/7 9/10		K45	91703-0006/9	90879-7984	A
90879-7017	91703-0005/8	91704-9013	NATURAL	1b 11b	03c d90	3/4 8/9		K43	91703-0006/9	90879-7983	A
90879-7006	91703-0005/8	91704-9014	NATURAL	1b 2a 3a 4b 6b	01c d40 d60 011c	1/2 3/4 5/6 7/8 9/10		K35	91703-0006/9	90879-7993	A
90879-7011	91703-0005/8	91704-9015	NATURAL	1b 3a 4b 7a 10b	01c 04c d50 07c	1/2 4/5 7/8 9/10		K40	91703-0006/9	90879-7988	A
90879-7012	91703-0005/8	91704-9016	NATURAL	1b 2a 3a 4b 6b 7a 8a 8b	01c d40 d60 d80 011c	1/2 3/4 5/6 9/10		K42	91703-0006/9	90879-7987	A

12 CIRCUIT

SEE CODE DESIGNATION TABLE FOR NUMBERING FORMAT WHEN ADDING NEW PART NUMBERS										P.C.B. POLARISATION OPTION	
PART NO. (TRN)	TERM NO. (TRN)	MOLEX HOUSING NO.	COLOR	UNBLOCKED POSITION KEYS	UNBLOCKED CODING KEYS	LATCH POSITION	CONFIGURATION (SEE NOTES)	LUMBERG K REF	TERM NO. (SILVER)	PART NO. (SILVER)	P.C.B. POLARISATION OPTION
90879-8002	91703-0005/8	91704-9500	NATURAL	1b 7a 8b 12b	d10 04c 09c d100 d120	2/3 4/5 7/8 11/12		K30	91703-0006/9	90879-8997	A
90879-8001	91703-0005/8	91704-9501	NATURAL	2a 4b 5b 6b 7a 10a 12a 12b	d10 d30 d50 d70 09c d100 d120	2/3 4/5 6/7 9/10 11/12		K34	91703-0006/9	90879-8996	A
90879-8003	91703-0005/8	91704-9502	NATURAL	1a 3b 7b 9b 11b 12a	01c d20 d40 05c 07c 011c	1/2 3/4 5/6 7/8 9/10 11/12		K44	91703-0006/9	90879-8995	A
90879-8004	91703-0005/8	91704-9503	NATURAL	1b 2a 2b 4a 5b 6a 8a 9a 10a 11a 12b	d30 04c 06c 09c 011c	1/2 4/5 6/7 9/10 11/12		K46	91703-0006/9	90879-8994	A
90879-8005	91703-0005/8	91704-9504	NATURAL	2b 3b 4a 8b 9b 11a	01c d20 d40 d90 d100 d120	1/2 3/4 8/9 11/12		K49	91703-0006/9	90879-8992	A
90879-8006	91703-0005/8	91704-9505	NATURAL	1a 2b 3a 5b 11b 12a	01c 03c d40 d60 07c 09c	1/2 3/4 5/6 7/8 9/10 11/12		K47	91703-0006/9	90879-8993	A
90879-8008	91703-0005/8	91704-9506	NATURAL	1a 5b 7b	01c d30 04c d70 012c	2/3 4/5 6/7 8/9 10/11		K50	91703-0006/9	90879-8991	A

SEE SHEET 1 SEC NO: IPZ017-0179 DRAWN:ZGRANER 2016/08/16 CHKD: APPR:BRUTTE 2016/08/30 REV	QUALITY SYMBOLS	GENERAL TOLERANCES (UNLESS SPECIFIED)	DIMENSION STYLE	SCALE	DESIGN UNITS	THIRD ANGLE PROJECTION
	▽=0	mm INCH	MM ONLY	1:1	METRIC	RAST 5 R.A. HDR
	▽=0	4 PLACES ± --- ± --- 3 PLACES ± --- ± --- 2 PLACES ± 0.1 ± --- 1 PLACE ± 0.2 ± --- 0 PLACE ± ±	DRAWN BY DATE NMCNAMAR 2004/05/22 CHECKED BY DATE JDENNEHY 2004/05/23 APPROVED BY DATE BMAGUIRE 2004/05/27	DOCUMENT NO. SD-90879-001		
	ANGULAR ± 2 °	DRAFT WHERE APPLICABLE MUST REMAIN WITHIN DIMENSIONS	SEE CHARTS	SHEET NO. 7 OF 7		

THIS DRAWING CONTAINS INFORMATION THAT IS PROPRIETARY TO MOLEX INCORPORATED AND SHOULD NOT BE USED WITHOUT WRITTEN PERMISSION