

# User Guide

Sentrius RG1xx / RG191+LTE

*Version 6.1*

---

## REVISION HISTORY

| Ver. | Date          | Notes   | Contributor(s)   | Approver       |
|------|---------------|---|--|----------------|
| 1.0  | 20 July       | Initial Release   |  | Jonathan Kaye  |
| 1.1  | 3 Aug 2017    | Clarified web interface URL.<br>Identified separate mDNS address.   |  | Shewan Yitayew |
| 1.2  | 29 Nov 2017   | Update info for compatibility with GA2 (93.7.2.x) firmware.<br>Add compliance information. Add IP67 Rated Version Specs         |  | Jonathan Kaye  |
| 2.0  | 13 Dec 2017   | Changed Rev # to 2.0 to match engineering release   |  | Jonathan Kaye  |
| 2.1  | 04 Jan 2018   | Miscellaneous text and grammatical edits  |  | Shewan Yitayew |
| 2.2  | 10 Jan 2018   | Adding Ordering Information   |  | Jonathan Kaye  |
| 3.0  | 28 Feb 2018   | Adding UAE Certification Compliance, Firmware update info   |  | RG, RDE        |
| 3.1  | 15 Mar 2018   | Added note to Wi-Fi Quick Configuration section regarding available firmware version. Updated to new template                   |  | Jonathan Kaye  |
| 3.2  | 29 Mar 2018   | Removed inapplicable Firmware update URLs   | Sue White  | Jonathan Kaye  |
| 3.3  | 13 Apr 2018   | Important update to firmware upgrade procedure  | Ryan Erickson  | Shewan Yitayew |
| 3.4  | 30 May 2018   | Updates for GA3 firmware. Add section for web session timeout.<br>Update firmware upgrade section.                              | Ryan Erickson  | Jonathan Kaye  |
| 3.5  | 20 Aug 2018   | Updated Outdoor Enclosure Connector Layout  | Robert Gosewehr  | Jonathan Kaye  |
| 3.6  | 19 Dec 2018   | Updated logos and URL   | Sue White  | Jonathan Kaye  |
| 3.7  | 7 Mar 2019    | Updated Section 9.4.2 for clarity<br>Updated template   | Robert Gosewehr<br>Sue White                                 | Jonathan Kaye  |
| 3.8  | 11 Oct. 19    | Added AS923/AU915 Region Support  | Robert Gosewehr<br>Adam Ruehl<br>Raj Khatri<br>Chris Boorman | Jonathan Kaye  |
| 3.9  | 8 Nov 19      | Update remote management section to include information about uploading and downloading configuration files for LoRa and Wi-Fi. | Adam Ruehl   | Chris Boorman  |
| 4.0  | 4 Feb 2020    | Updates for GA5   | Adam Ruehl   | Chris Boorman  |
| 4.1  | 17 April 2020 | Added URL for GA4.1   | Adam Ruehl   | Chris Boorman  |
| 5.0  | 19 Dec 2020   | Updated all regulatory information  | Maggie Teng<br>Ryan Urness                                   | Jonathan Kaye  |
| 5.1  | 5 Jan 2021    | Updates for GA5.2   | Adam Ruehl   | Chris Boorman  |
| 5.2  | 6 Apr 2021    | Updated regulatory definition/detail  | Chris Boorman  | Jonathan Kaye  |
| 6.0  | 25 May 2021   | Updated for GA6 + migration of RG191+LTE gateway user guide content   | Adam Ruehl<br>Robert Gosewehr                                | Chris Boorman  |
| 6.1  | 20 Dec 2021   | Updated firmware update section for new release   | Adam Ruehl   | Chris Boorman  |

## CONTENTS

|       |  |    |
|-------|--|----|
| 1     | About this Guide.....  | 6  |
| 2     | Introduction .....   | 6  |
| 2.1   | Product Overview .....                                       | 6  |
| 2.2   | Specification .....  | 7  |
| 2.3   | Ordering Information.....                                    | 10 |
| 3     | Connecting the Hardware .....                                | 11 |
| 3.1   | Connect the Gateway .....                                    | 11 |
| 3.1.1 | SIM Card Installation.....                                   | 11 |
| 3.1.2 | Antenna Configuration .....                                  | 14 |
| 3.1.3 | Wi-Fi Quick Configuration .....                              | 14 |
| 4     | Log into the Gateway .....                                   | 15 |
| 5     | LTE Connection setup.....                                    | 17 |
| 5.1   | Status – Modem and Network Information.....                  | 18 |
| 5.2   | Settings – APN (User) Profile Configuration .....            | 19 |
| 5.3   | Advance Settings – Alternative DNS Server Configuration..... | 20 |
| 6     | LAN Connection Setup.....                                    | 21 |
| 6.1   | IPv4 Configuration .....                                     | 21 |
| 6.2   | IPv6 Configuration .....                                     | 21 |
| 6.3   | Advanced View .....  | 22 |
| 7     | Wi-Fi Connection Setup .....                                 | 23 |
| 7.1   | Use Scan to Add a Profile.....                               | 23 |
| 7.2   | Manually Adding a Profile .....                              | 24 |
| 7.3   | Wi-Fi Advanced Page .....                                    | 25 |
| 8     | LoRa Connection Setup .....                                  | 26 |
| 8.1   | Using Presets .....  | 26 |
| 8.2   | Semtech Basic Station.....                                   | 27 |
| 8.2.1 | Mode.....  | 27 |
| 8.2.2 | Servers.....   | 27 |
| 8.2.3 | Certificates .....   | 28 |
| 8.2.4 | Connection Status.....                                       | 28 |
| 8.3   | Senet .....  | 29 |
| 8.4   | Semtech Legacy UDP Forwarder .....                           | 29 |
| 8.4.1 | Mode.....  | 29 |
| 8.4.2 | Configuration.....   | 29 |
| 8.4.3 | Radios.....  | 30 |
| 8.4.4 | LoRa Radio Card (Australia) .....                            | 33 |
| 8.4.5 | LoRa Radio Card (New Zealand).....                           | 33 |

|        |   |    |
|--------|---|----|
| 8.4.6  | LoRa Radio Card (Taiwan) .....                      | 33 |
| 8.4.7  | LoRa Radio Card (Hong Kong) .....                   | 34 |
| 8.4.8  | LoRa Radio Card (Singapore).....                    | 34 |
| 8.5    | Advanced Configuration.....                         | 34 |
| 8.6    | Traffic.....  | 35 |
| 9      | Manage the Gateway .....                            | 36 |
| 9.1    | Changing Username and Password .....                | 36 |
| 9.2    | Web Session.....                                    | 37 |
| 9.3    | Version Information.....                            | 37 |
| 9.3.1  | Modem Version Information .....                     | 37 |
| 9.4    | Updating Gateway Firmware .....                     | 38 |
| 9.4.1  | Firmware Update URLs.....                           | 39 |
| 9.4.2  | Cellular Modem Firmware Updates.....                | 40 |
| 9.5    | Save/Restore Settings .....                         | 41 |
| 9.6    | Remote Management .....                             | 42 |
| 9.6.1  | Configuring the Gateway for Remote Management ..... | 42 |
| 9.6.2  | Updating Firmware Remotely.....                     | 42 |
| 9.6.3  | Configuration File Upload.....                      | 42 |
| 9.6.4  | Configuration File Download.....                    | 43 |
| 9.6.5  | The Sentrius Gateway's TR-069 Data Model.....       | 43 |
| 9.7    | Debug .....   | 53 |
| 9.8    | Factory Reset .....                                 | 54 |
| 9.9    | Bluetooth.....                                      | 54 |
| 10     | IP67 Rated Enclosure .....                          | 55 |
| 10.1   | Specification .....                                 | 57 |
| 10.2   | LED Display Reference.....                          | 58 |
| 10.2.1 | Three LED Display with User Button.....             | 58 |
| 10.2.2 | Six LED Display .....                               | 58 |
| 10.3   | Previous Generation Connector Adapter Layout .....  | 59 |
| 10.4   | Cable Assemblies .....                              | 59 |
| 10.4.1 | Power Supply and Ethernet Module.....               | 59 |
| 10.4.2 | Assembly Steps .....                                | 60 |
| 10.5   | Mounting Hardware .....                             | 61 |
| 10.5.1 | Wall Mount.....                                     | 61 |
| 10.5.2 | Pole Mount.....                                     | 62 |
| 11     | Regulatory.....                                     | 63 |
| 11.1   | Current Regulatory Certifications.....              | 63 |
| 11.2   | Documentation Requirements .....                    | 63 |
| 11.3   | FCC Regulatory .....                                | 63 |

|        |  |    |
|--------|--|----|
| 11.3.1 | RG191  | 63 |
| 11.3.2 | RG191+LTE  | 64 |
| 11.3.3 | LTE Network Certification                                | 64 |
| 11.3.4 | Power Exposure Information                               | 64 |
| 11.3.5 | OEM Responsibilities                                     | 64 |
| 11.3.6 | FCC Interference Statement                               | 65 |
| 11.3.7 | FCC Warning  | 65 |
| 11.4   | ISED (Canada) Regulatory                                 | 65 |
| 11.4.1 | ISED Warning   | 65 |
| 11.4.2 | ISED Radiation Exposure Statement                        | 65 |
| 11.5   | Australia and New Zealand Regulatory                     | 66 |
| 11.6   | Taiwan (NCC) Regulatory                                  | 66 |
| 11.7   | EU Regulatory  | 66 |
| 11.7.1 | User's Guide Requirements                                | 66 |
| 11.7.2 | EU Declarations of Conformity                            | 69 |
| 12     | Telecommunications Regulatory Authority (TRA) Compliance | 70 |
| 12.1   | Labelling Requirements                                   | 70 |
| 13     | Region Supported Labels                                  | 71 |
| 13.1   | RG186 Version  | 71 |
| 13.2   | RG191 Version  | 71 |
| 13.3   | RG191+LTE Version  | 71 |
| 13.4   | AU915 & AS923 Regions                                    | 72 |
| 13.4.1 | Taiwan (TW)  | 72 |
| 13.4.2 | New Zealand (NZ)   | 72 |
| 13.4.3 | Hong Kong (HK)   | 72 |
| 13.4.4 | Australia (AU)   | 73 |
| 13.4.5 | Singapore (SG)   | 73 |

# 1 ABOUT THIS GUIDE

This document is the parent guide of the *RG1xx Quick Start Guide* and provides a comprehensive guide on how to configure the **Sentrius™ RG1xx** gateways to suit the intended application. It covers all the **Sentrius™ RG1xx** functionality, including Ethernet, Wi-Fi and LoRa configurations. It also provides instructions for setting up the gateway on a LoRa network server.

All sections describing LTE operation are for features only available on the RG191+LTE model.  
All other hardware models **do not** contain the required LTE modem.

**Note:** Step-by-step instruction, screen shots, and pictures are based on the **Sentrius™ RG191**, but the same is applicable for the **Sentrius™ RG186** and other AS915, AU923 variants; differences are highlighted in the notes.

# 2 INTRODUCTION

## 2.1 Product Overview

Laird's **Sentrius™ RG1xx** LoRa-Enabled Gateway is the ultimate in secure, scalable, robust LoRa solutions for end-to-end control of your private LoRaWAN network. Leveraging Laird Connectivity's field-proven and reliable 50 Series *Wireless Bridge* certified module, it also offers enterprise dual-band Wi-Fi and wired Ethernet for complete design freedom. Based on the Semtech SX1301/SX1257 chipset designs, it offers a LoRa range up to ten miles and pre-loaded LoRa Packet Forwarder software, perfect for highly scalable, flexible IoT networks. The Sentrius RG1xx Gateway works with Laird's **Sentrius™ RM1xx Series LoRa+BLE** certified modules for simple out-of-the-box integration and is compatible with third-party cloud and LoRa partners, as well as any LoRaWAN-certified client devices.



LTE hardware and connectivity only available on RG191+LTE models.

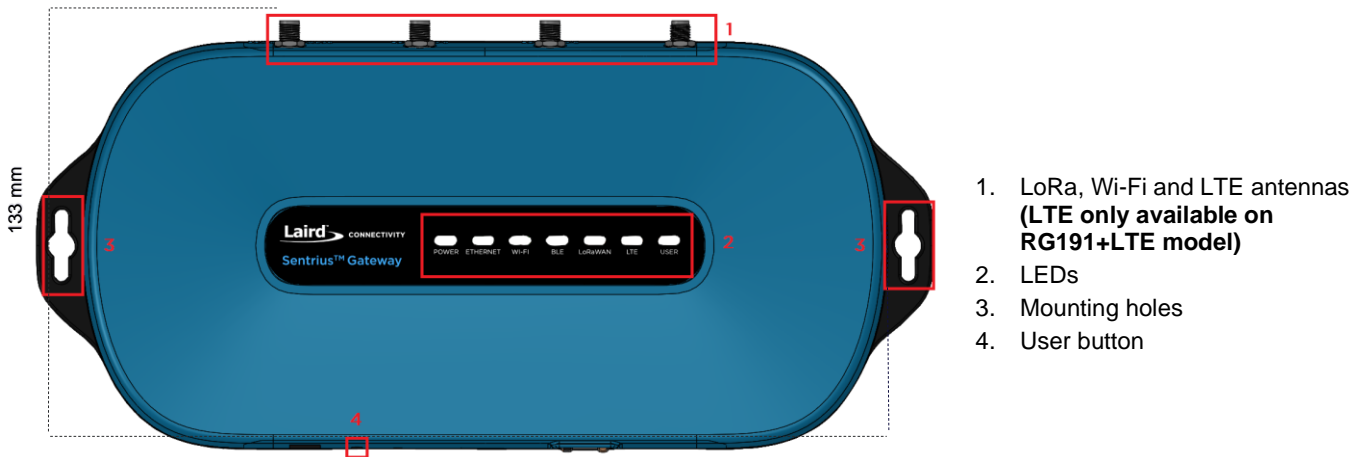

Figure 1: Top of the Sentrius™ RG1xx gateway

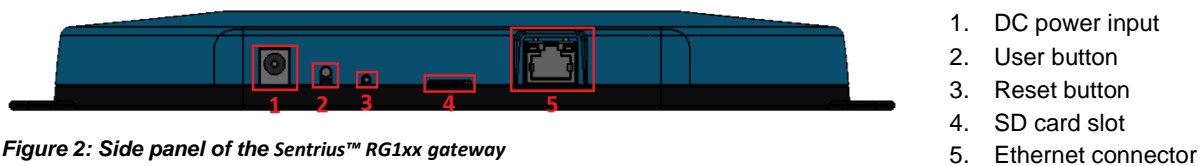

Figure 2: Side panel of the Sentrius™ RG1xx gateway

## 2.2 Specification

| Category   | Feature  | Specification                                  |        |
|--|--|--|--------|
| Chipset  | LoRa®  | Semtech SX1301/SX1257                          |        |
|  | Bluetooth®   | Cambridge Silicon Radio CSR8811 A08            |        |
|  | Wi-Fi  | Qualcomm Atheros QCA6004                       |        |
|  | LTE CAT 1 (Only within RG191+LTE)  | Quectel EG91-NA                                |        |
| Wireless Characteristics   | Wi-Fi Spatial Streams  | 2x2 MIMO                                       |        |
|  | Wi-Fi Frequencies  | 2.4 and 5 GHz operation                        |        |
|  | FCC/IC conducted WiFi transmit power (for single stream)   | <b>802.11a</b><br>6 Mbps                       | 17 dBm |
|  |  | 54 Mbps  | 14 dBm |
|  | <i>Note: Transmit power on each channel varies according to individual country regulations. All values for lowest data rate are nominal, +/- 2 dB.</i> | <b>802.11b</b><br>1 Mbps                       | 17 dBm |
|  |  | 11 Mbps  | 17 dBm |
|  | <i>Note:<br/>HT40 – 40 MHz-wide channels<br/>HT20 – 20 MHz-wide channels</i>   | <b>802.11g</b><br>6 Mbps                       | 17 dBm |
|  |  | 54 Mbps  | 14 dBm |
|  |  | <b>802.11n (2.4 GHz)</b><br>6.5 Mbps (MCS0)    | 17 dBm |
|  |  | 65 Mbps (MCS7)                                 | 13 dBm |
|  |  | <b>802.11n (5 GHz)</b><br>6.5 Mbps (MCS0,HT20) | 17 dBm |
|  |  | 65 Mbps (MCS7, HT20)                           | 13 dBm |
|  |  | (MCS0, HT40)                                   | 14 dBm |
|  |  | (MCS7, HT40)                                   | 11 dBm |
| ETSI (CE) RG186 conducted WiFi transmit power (for single stream)  | <b>802.11a (5GHz band)</b><br>6 Mbps   | 14 dBm   |        |
|  | 54 Mbps  | 14 dBm   |        |
| <i>Note: Transmit power on each channel varies according to individual country regulations. All values for lowest data rate are nominal, +/-2.0dB.</i> | <b>802.11b (2.4GHz band)</b><br>1 Mbps   | 10 dBm   |        |
|  | 11 Mbps  | 10 dBm   |        |
| <i>Note:<br/>HT40 – 40 MHz-wide channels<br/>HT20 – 20 MHz-wide channels</i>   | <b>802.11g (2.4GHz band)</b><br>6 Mbps   | 11dBm  |        |
|  | 54 Mbps  | 11dBm  |        |
|  | <b>802.11n (2.4GHz band)</b><br>6.5 Mbps (MCS0)  | 11dBm  |        |
|  | 65 Mbps (MCS7)   | 11dBm  |        |
|  | <b>802.11n (5GHz band)</b><br>6.5Mbps (MCS0, HT20)   | 14dBm  |        |
|  | 65 Mbps (MCS7, HT20)   | 13dBm  |        |
|  | 6.5 Mbps (MCS0,HT40)   | 14dBm  |        |
|  | 65 Mbps (MCS7,HT40)  | 11dBm  |        |
| <i>Note: Bluetooth support not included at a software level within the RG1xx</i>   | <b>Bluetooth Low Energy</b><br>1 Mbps  | 6 dBm  |        |

| Category  | Feature  | Specification   |   |
|---|--|---|---|
|   | <b>Wi-Fi Radio</b>   | <b>802.11a</b>  |   |
|   | <b>Conducted Typical Receiver Sensitivity</b>                                      | 6 Mbps   -92 dBm<br>54 Mbps   -74 dBm (PER <= 10%)  |   |
|   | <i>Note: All values nominal, ±3 dBm. Variant by channels.</i>                      | <b>802.11b</b>  |   |
|   |  | 1 Mbps   -94 dBm<br>11 Mbps   -87 dBm (PER <= 8%)   |   |
|   |  | <b>802.11g</b>  |   |
|   |  | 6 Mbps   -91 dBm<br>54 Mbps   -74 dBm (PER <= 10%)  |   |
|   |  | <b>802.11n (2.4 GHz)</b>  |   |
|   |  | 6.5 Mbps (MCS0)   -91 dBm<br>65 Mbps (MCS7)   -71 dBm   |   |
|   |  | <b>802.11n (5 GHz HT20)</b>   |   |
|   |  | 6.5 Mbps (MCS0)   -92 dBm<br>65 Mbps (MCS7)   -71 dBm   |   |
|   |  | <b>Bluetooth Low Energy</b>   |   |
|   |  | 1 Mbps   -86 dBm  |   |
| <b>LoRa - Wireless Characteristics</b>          | <b>LoRa Frequencies, LoRaWAN Region, UL/DL, Laird part number</b>                  | EU   863 – 870 MHz (LoRaWAN EU863-870, UL/DL) –RG186  |   |
|   |  | US   902 – 928 MHz (LoRaWAN US902-928, UL) – RG191  |   |
|   |  | NZ   918.2 – 927.6 MHz (LoRaWAN AS923 UL/DL) – 455-00055  |   |
|   |  | AU   923.3 – 927.5 MHz (LoRaWAN AU915-928, UL) – 455-00057  |   |
|   |  | AU   915.4 – 927.7 MHz (LoRaWAN AS923, UL/DL) – 455-00057   |   |
|   |  | TWN   920.2 – 924.8 MHz (LoRaWAN AS923, UL/DL) – 455-00054  |   |
|   |  | HK   920.2 – 924.8 MHz (LoRaWAN AS923, UL/DL) – 455-00056   |   |
|   |  | SG   920 – 925 MHz (LoRaWAN AS923, UL/DL) – 455-00102   |   |
|   |  | <b>LoRa Radio Conducted TX Power (at -40°C) (RG191 plus AS915 &amp; AU923 variants)</b>   | US   28 dBm (max entry in Radio TX Power Table) |
|   |  | NZ   24 dBm (max entry in Radio TX Power Table)   |   |
|   | AUS   27 dBm (max entry in Radio TX Power Table), AU915 and AS923                  |   |   |
|   | TWN   25 dBm (max entry in Radio TX Power Table)                                   |   |   |
|   | HK   25 dBm (max entry in Radio TX Power Table)                                    |   |   |
| SG   27 dBm (max entry in Radio TX Power Table) |  |   |   |
|   | US, NZ, AUS, TWN, HK, SG   0 dBm (min entry in Radio TX Power Table)               |   |   |
|   | <b>LoRa Radio Conducted RX Sensitivity (RG191 plus AS915 &amp; AU923 variants)</b> | -127 dBm (Bandwidth = 125 kHz, Spreading Factor = 7, DR0)   |   |
|   | <b>LoRa Radio Conducted TX Power (at -40°C) (RG186)</b>                            | Supports TX power as per ETSI Frequency bands<br>25 dBm (max entry in Radio TX Power Table)<br>-3 dBm (min entry in Radio TX Power Table) |   |
|   | <b>LoRa Radio Conducted RX Sensitivity (RG186)</b>                                 | -125 dBm (Bandwidth = 125 kHz, Spreading Factor = 7, DR0)<br>-123 dBm (Bandwidth = 250 kHz, Spreading Factor = 7, DR6)                    |   |
| <b>Interfaces</b>                               | <b>Wired</b>   | Ethernet - RJ45 Connector   |   |
|   | <b>Wireless</b>  | LoRa, 802.11a/b/g/n, Cellular LTE ( <b>Only RG191+LTE model</b> )   |   |
| <b>Power</b>                                    | <b>Supply Voltage</b>  | 12V/1A  |   |



| Category             | Feature                      | Specification  |
|----------------------|------------------------------|--|
|                      | <b>Power Adapter</b>         | External DC Power Supply (has 12V /2A rating) with regional plug adapter   |
| <b>Security</b>      | <b>Wi-Fi</b>                 | Standards – WEP, WPA, WPA2<br>Encryption – WEP, TKIP, AES<br>EAP Types – EAP-FAST, EAP-TLS, EAP-TTLS, PEAP-GTC, PEAP-MSCHAP, PEAP-MSCHAPv2, PEAP-TLS, LEAP   |
| <b>Software</b>      | <b>Operating System</b>      | Embedded Linux, 4.x Kernel   |
|                      | <b>LoRa</b>                  | Packet Network Forwarder with default support for the following: <ul style="list-style-type: none"> <li>▪ The Things Network with Semtech Basics Station or UDP forwarder</li> <li>▪ Stream communications with UDP forwarder</li> <li>▪ ChirpStack with UDP forwarder or Semtech Basics Station</li> <li>▪ Senet through legacy Semtech UDP or proprietary Senet forwarder</li> </ul> |
|                      | <b>Configuration</b>         | Web-based interface via Ethernet/Wi-Fi or remote via TR-069 protocol (requires ACS)  |
| <b>Physical</b>      | <b>Dimensions</b>            | 133 x 275 x 30 mm (enclosure only)   |
| <b>Environmental</b> | <b>Operating Temperature</b> | -30° to +70°C<br><i>Note: The RG1xx gateway operating temperature range is limited to -30° to +70°C due to the supplied external power supply. The RG1xx gateway without the external power supply is certified for -40° to +85°C.</i>   |
| <b>Regulatory</b>    | <b>Approvals (RG186)</b>     | <b>CE</b><br>Health and Safety – IEC 60950-1 V2.0<br>Radio – EN300 220-1 V3.1.1 (2017-02); EN300-220-2 V3.1.1 (2017-02)<br>EMC – EN301 489-1 V2.2.0 (2017-03); EN301 489-3 V2.1.1 (2017-03)  |
|                      | <b>Approvals (RG191)</b>     | <b>FCC</b> – Contains FCC ID: SQG-WB50NBT<br><b>IC</b> – Contains IC ID: 3147A-WB50NBT<br><b>FCC</b> – Contains FCC ID: SQG-1001<br><b>IC</b> – Contains IC ID: 31347A-1001<br><b>NZ</b> – AS/NZS 4268:2017<br><b>AUS</b> – AS/NZS 4268:2017<br><b>TWN</b> – NCC LP0002<br><b>SG</b> – DA107248<br><b>PTCRB (LTE Version)</b> – Covers Bands 2, 4, 5, 12, & 13                         |
| <b>Wi-Fi Antenna</b> | <b>Model</b>                 | Laird MAF94051   |
|                      | <b>Type</b>                  | Dipole   |
|                      | <b>Connector</b>             | RP-SMA   |
|                      | <b>Antenna Gain</b>          | 2.1 dBi (2.4-2.5 GHz), 2.4 dBi (4.9 GHz) 2.6 dBi (5.25 GHz), 3.4 dBi (5.875 GHz)   |
| <b>LoRa Antenna</b>  | <b>Model</b>                 | Laird 001-0028 (863-870 MHz) used with RG186<br>Laird 001-0002 (902-928 MHz) used with RG191 plus AS915 and AU923 variants   |
|                      | <b>Type</b>                  | Dipole   |
|                      | <b>Connector</b>             | RP-SMA (001-0002 & 001-0028)   |

| Category           | Feature             | Specification   |
|--------------------|---------------------|---|
|                    | <b>Antenna Gain</b> | 2.0 dBi (863-870 MHz) used with RG186<br>2.0 dBi (902-928 MHz) used with RG191 plus AS915 and AU923 variants  |
| <b>LTE Antenna</b> | <b>Model</b>        | Laird DBA6927C1-FSMAM   |
|                    | <b>Type</b>         | Dipole  |
|                    | <b>Connector</b>    | SMA-Male  |
|                    | <b>Antenna Gain</b> | 0.5 dBi (698-960 MHz) – 2.2 dBi (1710-2700 MHz) used with RG191+LTE   |
| <b>Accessories</b> | <b>Included</b>     | 1 x 863-870 MHz antenna (with RG186) or 1 x 902-928 MHz antenna (with RG191, AS915 and AU923 variants)<br>2 x 2.4/5 GHz Wi-Fi antennas<br>1 x 698-960/1710-2700 MHz LTE antenna (with RG191+LTE)<br>1 x External DC power adapter |
| <b>Enclosure</b>   | <b>Standard</b>     | Moulded plastic housing   |
| <b>Warranty</b>    |                     | One-year warranty   |

## 2.3 Ordering Information

**IMPORTANT NOTE:** The region setting of the radio cannot be changed. The user must purchase the appropriate model for the desired region of operation and only use the model **appropriate for the location in which they will install the gateway.**

Table 1: Ordering information

| Part Number         | Description   |
|---------------------|---|
| <b>RG191</b>        | Sentrius™ RG191 US (US902-928) 915 MHz Gateway - LoRaWAN, Wi-Fi, and Ethernet – US Power Adapter          |
| <b>RG186</b>        | Sentrius™ RG186 Europe (EU868) 868 MHz Gateway - LoRaWAN, Wi-Fi, and Ethernet – EU Power Adapter          |
| <b>455-00028</b>    | Sentrius™ RG186 United Kingdom (EU868) 868 MHz Gateway - LoRaWAN, Wi-Fi, and Ethernet – UK Power Adapter  |
| <b>450-0190</b>     | Sentrius™ RG186 Europe (EU868) 868 MHz Gateway – LoRaWAN, Wi-Fi, and Ethernet – IP67                      |
| <b>450-0191</b>     | Sentrius™ RG191 US (US902-928) 915 MHz Gateway – LoRaWAN, Wi-Fi, and Ethernet – IP67                      |
| <b>455-00054</b>    | Sentrius™ RG191 Taiwan (AS923) 923 MHz Gateway - LoRaWAN, Wi-Fi, and Ethernet – TW Power Adapter          |
| <b>455-00055</b>    | Sentrius™ RG191 New Zealand (AS923) 923 MHz Gateway – LoRaWAN, Wi-Fi, and Ethernet – NZ Power Adapter     |
| <b>455-00056</b>    | Sentrius™ RG191 Hong Kong (AS923) 923 MHz Gateway – LoRaWAN, Wi-Fi, and Ethernet – HK Power Adapter       |
| <b>455-00057</b>    | Sentrius™ RG191 Australia (AU915+AS923) 923 MHz Gateway – LoRaWAN, Wi-Fi, and Ethernet – AU Power Adapter |
| <b>455-00102</b>    | Sentrius™ RG191 Singapore (AS923) 923 MHz Gateway – LoRaWAN, Wi-Fi, and Ethernet – UK Power Adapter       |
| <b>450-00107-K1</b> | Sentrius™ RG191 US (US902-928) 915 MHz Gateway - LoRaWAN, Wi-Fi, Ethernet and LTE, CAT-1, NA              |
| <b>450-00109-K1</b> | Sentrius™ RG191 US (US902-928) 915 MHz Gateway - LoRaWAN, Wi-Fi, Ethernet and LTE, CAT-1, NA – IP67       |
| <b>Accessories</b>  |   |
| <b>690-1002</b>     | Pole Mount Bracket - Accessory for 450-0190 or 450-0191   |
| <b>690-1003</b>     | Wall Mount Bracket - Accessory for 450-0190 or 450-0191   |

## 3 CONNECTING THE HARDWARE

### 3.1 Connect the Gateway

To use the gateway, you must power up the gateway and access the web interface via the Ethernet port. To do this, follow these steps:

1. Follow the label on the box and connect the three (or 4 with RG1291+LTE) antennas. Refer to [Antenna Configuration](#) section for additional information
2. Connect the power supply (see #2 in [Figure 3](#)).
3. Connect the gateway to your router (#3 in [Figure 3](#)) using the Ethernet cable (#1 in [Figure 3](#)).  
Alternatively use the Wi-Fi Quick Config mechanism. Refer to [Wi-Fi Quick Configuration](#) for additional information

Your gateway is now connected and ready

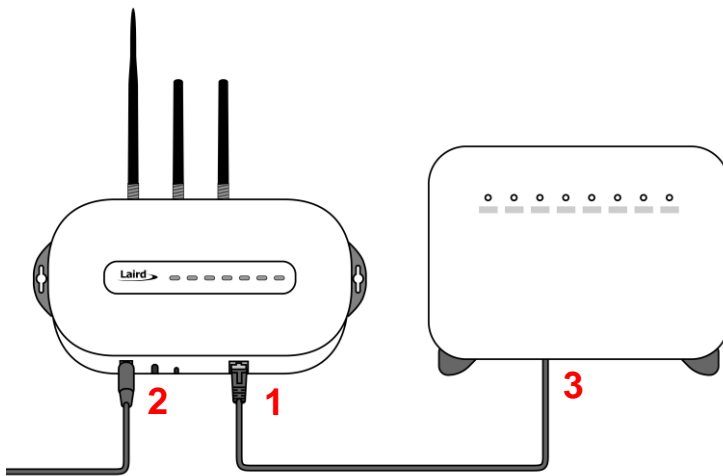

Figure 3: Connecting the gateway

#### 3.1.1 SIM Card Installation

---

**Note:** This is only available with the RG191+LTE hardware for the US market only, see [Ordering Information](#) for product part numbers.

---

To utilize the LTE functionality, a cellular network provider's SIM card needs to be installed into the gateway. The recommended SIM card to purchase shall support LTE-CAT 1, in order to utilize the full capabilities of the LTE gateway.

---

**Note:** The RG191+LTE production units come with a Truphone SIM card pre-installed. The SIM will need to be registered and activated, see section [5.2](#).

---

To install the SIM card, follow these steps:

1. Unscrew the four (4) back Torx screws using a T8 Torx screwdriver for the non-IP67 gateway version. Unscrew the thirteen (13) screws using a Philips screwdriver for the IP67 gateway version.



**Figure 4: Gateway Screw Locations (Left: Standard; Right: IP67)**

2. Carefully move the top enclosure lid to the back of the gateway for the indoor (non-IP67) version as seen below. Remove the top lid for the IP67 gateway version (RF cables are not connected to the top cover on the IP67 gateway).



**Figure 5: Opened Gateway (indoor (non-IP67) gateway shown)**

---

**Note:** The RF cables are connected to the modules and glued in position. If the antennas are installed, remove the antennas before moving the top enclosure in position for the indoor (non-IP67) gateway.

---

3. If replacing the production installed SIM card, punch out the Micro-SIM (3FF size) from the Main Sim card (secondary set of punch out lines from the center moving outward).



Figure 6: SIM Card Punch-Out

4. Install the SIM card into the SIM card slot in the upper right location near the LTE modem making sure the copper contact side of the SIM card is facing down (follow Blue Arrow). Re-close the gateway and screw down the screws when complete.



Figure 7: SIM Install (Right: Picture of SIM card contact side)

**Note:** To remove the SIM card, push the card out from Red Arrow side and remove SIM.

### 3.1.2 Antenna Configuration

To configure the antenna properly, take the following steps:

1. Attach the two shorter antennas to the 2.4/5.5 GHz (Wi-Fi) ports.
2. Attach the third and longer antenna to the 868 MHz/900 MHz (LoRa) port.
3. Attach the fourth and wider blade antenna to the LTE port. **Notice the different connector types.** The LTE antenna will only fit in this port. This is only available on RG191+LTE hardware.

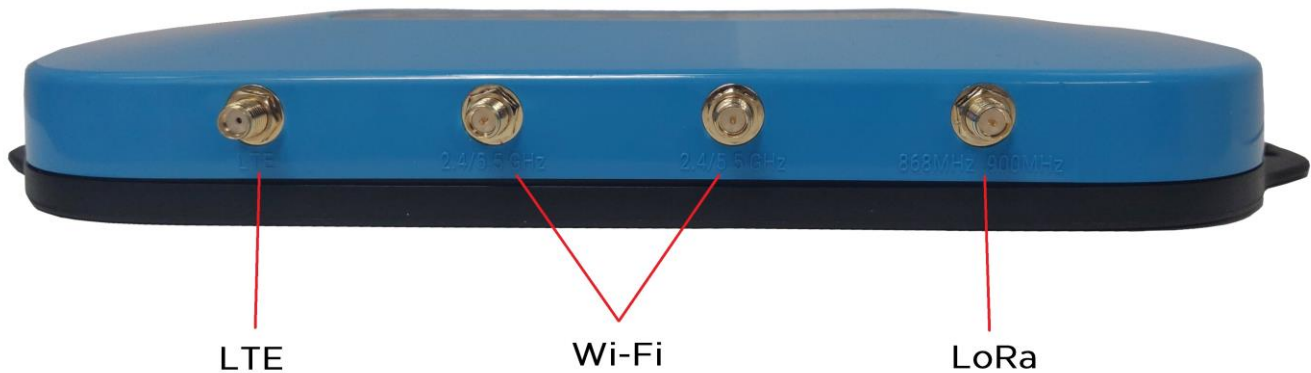

### 3.1.3 Wi-Fi Quick Configuration

**Note:** This feature only works with firmware version 93.7.2.9 and newer. Please verify your Gateway firmware version number and, if required, upgrade to a current version. Refer to [Updating Gateway Firmware](#) for additional information regarding this upgrade.

The gateway includes a mode to allow you to configure without ethernet access, in the case that you wish to join a wireless network.

Apply power to the gateway and allow to start, then perform the following:

1. Depress and hold the user button (see #2 in [Figure 2](#)) for seven seconds.
2. From a wirelessly enabled device perform a scan.
3. Connect to the access point rg1xx**29378B**, where 29378B are the last six digits of the Ethernet MAC address found on the label on the bottom of the gateway ([Figure 8](#)).

The network is secured with WPA2 with a password that is the same as the SSID. We recommend that you change the default password for security reasons. The password can be changed on the Wi-Fi > Advanced web page.

Upon logout or client disassociation, Wi-Fi Quick Config shuts down and normal operation resumes.

## 4 LOG INTO THE GATEWAY

To log into the gateway web interface, follow these steps:

1. Determine the last three bytes of your gateway's Ethernet MAC address. This can be found on the label on the bottom of the gateway; the last three bytes are highlighted (*Figure 8*).

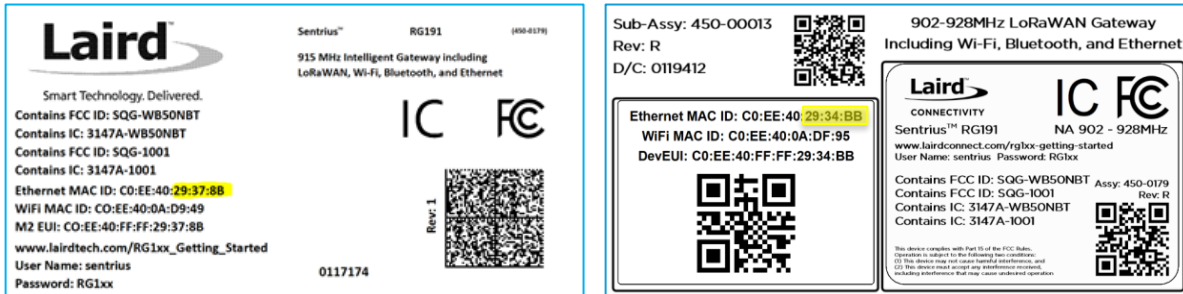

**Figure 8: Bottom label (Standard GW – Left, AS923 & AU915 Region Supported/Latest Version – Right)– last three bytes of the Ethernet MAC address highlighted**

2. Enter the URL into the web browser to access the web interface. For example, for the gateway used in this guide, the URL is <https://rg1xx29378B.local>, where “29378B” are the last six digits of the Ethernet MAC address. In Wi-Fi quick config mode, the gateway can also be accessed via the IP address at <https://192.168.1.1>
3. Accept the self-signed security certificate in the browser.
4. Click **Advanced** (*Figure 9*).

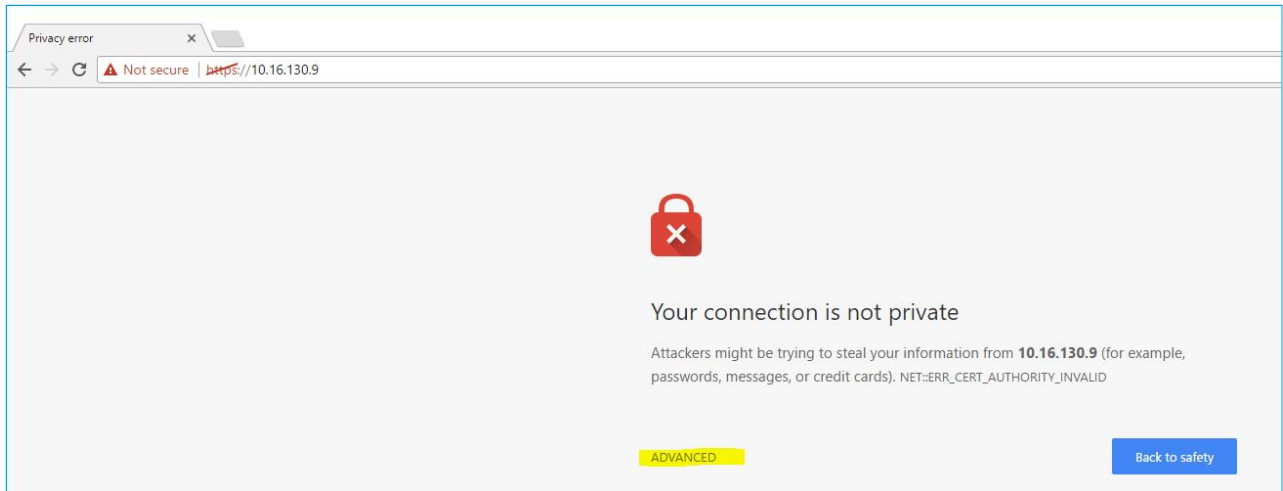

**Figure 9: Web interface – first screen**

5. Click **Proceed** (Figure 10).

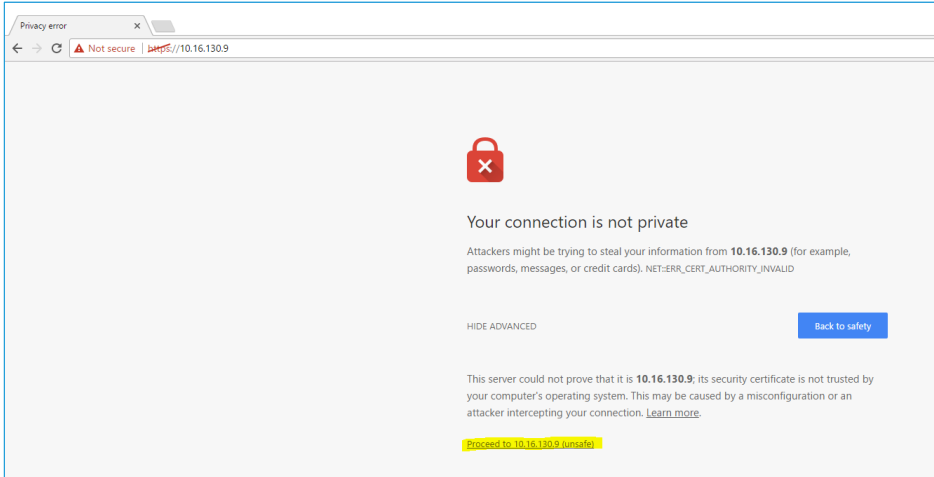

Figure 10: Web interface – second screen

6. Log on using the following default credentials:  
Username: sentrius  
Password: RG1xx

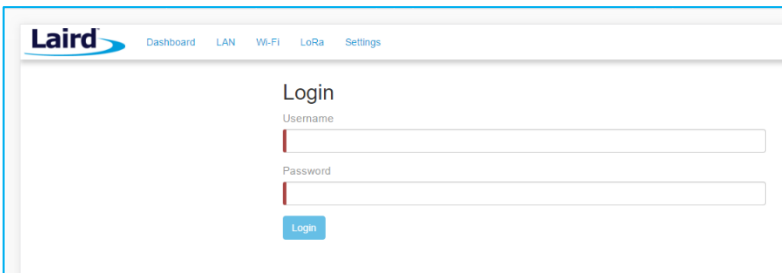

Figure 11: Gateway interface login screen

After logging in, the program warns you to change the default credentials for security reasons (Figure 12).

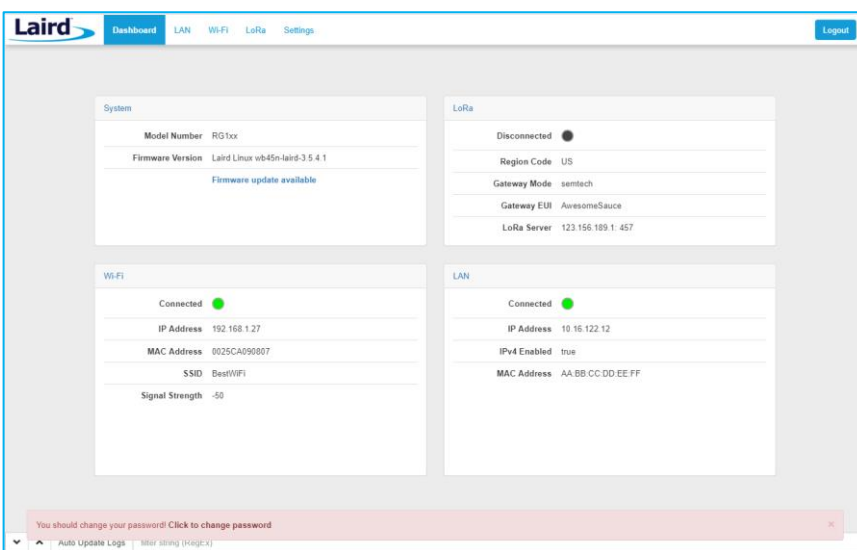

Figure 12: Change the default credentials



Only one login session is allowed at a time. If there is another active session active, the program warns you before allowing you to take over the session (Figure 13).

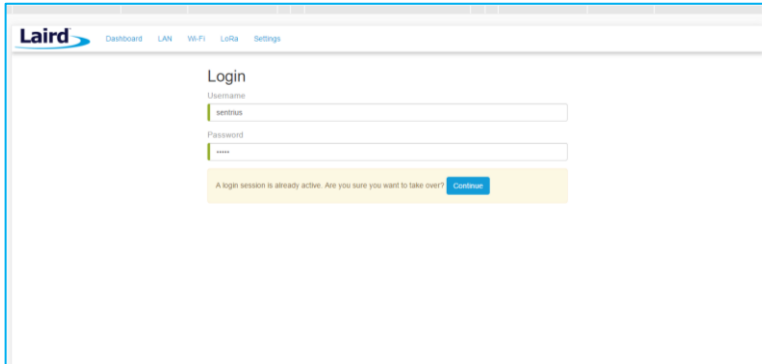

Figure 13: Active session warning

7. Click **Continue** to log in.

## 5 LTE CONNECTION SETUP

**Note:** This feature only works with the RG191+LTE hardware for the US market only, see [Ordering Information](#) for product part numbers.

The Cellular menu supports modem configuration and firmware updates. The current status of the integrated Cellular modem is also displayed. To access this section, click the **Cellular** tab from the ribbon at the top of the page.

In the sidebar on the left (Figure 14) you can navigate various Cellular pages. Further, you will find a button to enable/disable the Cellular modem.

**Note:** **By default, the Cellular modem within the gateway is disabled!! Users will need to enable it!!!**

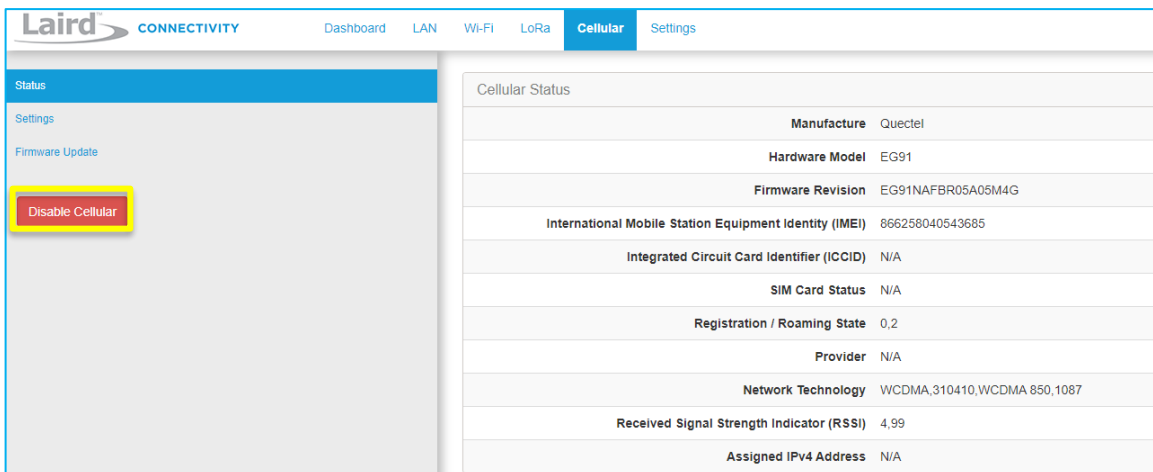

Figure 14: Enable/Disable Cellular Button

## 5.1 Status – Modem and Network Information

The first page when clicking on the Cellular menu is the **Status** page (Figure 15). You cannot change anything on this page. This page will provide you with information about the Cellular modem, inserted SIM card, and your network connection.

| Cellular Status  |                               |
|--|-------------------------------|
| Manufacture  | Quectel                       |
| Hardware Model   | EG91                          |
| Firmware Revision                                      | EG91NAFBR05A05M4G             |
| International Mobile Station Equipment Identity (IMEI) | 862831030036227               |
| Integrated Circuit Card Identifier (ICCID)             | 262011702145406               |
| SIM Card Status  | READY                         |
| Registration / Roaming State                           | 0.5                           |
| Provider   | Telekom.0.26201               |
| Network Technology                                     | FDD LTE_26201.LTE BAND 3.1300 |
| Received Signal Strength Indicator (RSSI)              | 24.99                         |
| Assigned IPv4 Address                                  | 10.211.135.173                |

Figure 15: Cellular Status page

- **Manufacture** – Shows the manufacturer identification of the integrated Cellular modem.
- **Hardware Model** – Shows the hardware model identification of the integrated Cellular modem.
- **Firmware Revision** – Shows the current firmware revision of the integrated Cellular modem.
- **International Mobile Station Equipment Identity (IMEI)** – Shows the IMEI number of the integrated Cellular modem.
- **Integrated Circuit Card Identifier (ICCID)** – Shows the ICCID number of the attached (U) SIM card (only if not locked).
- **SIM Card Status** – Shows the current state of the SIM card and whether a password (PIN/PUK) is required.
- **Registration / Roaming State** – Shows information about the network registration and roaming state.
- **Provider** – Shows information about the current service provider which the Cellular modem is attached to.
- **Network Technology** – Shows information about the current access technology and network frequency / band.
- **Received Signal Strength Indicator (RSSI)** – Shows information about the current received signal strength and channel bit error rate.

---

**Note:** A value of 99 indicates unknown or not detectable.

---

- **Assigned IPv4 Address** – Shows information about the public IPv4 address of the current mobile data connection.

---

**Note:** *N/A* means **Not Available**. In this case either parts of the Cellular modem are not fully initiated, or some information could not be obtained. Wait a few seconds and try it again by refreshing the page. If all fields show *N/A*, please make sure that the Cellular modem is turned on and installed properly.

---

## 5.2 Settings – APN (User) Profile Configuration

Select the Modem Configuration page by clicking the **Settings** menu item in the side menu of the Cellular view (Figure 16).

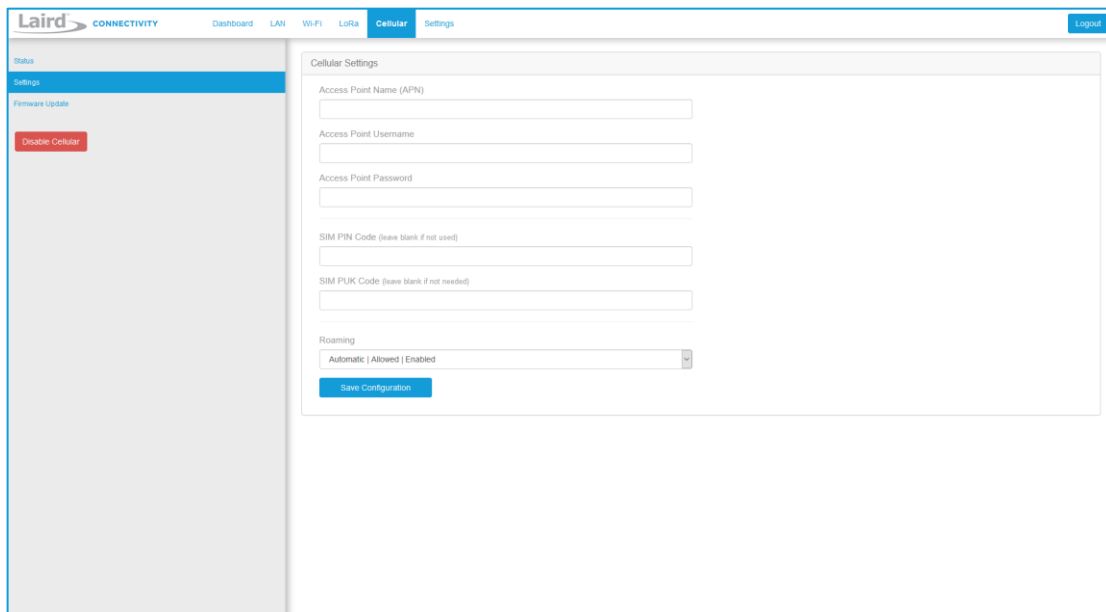

Figure 16: Cellular Settings page

1. Depending on your service provider that issued the SIM card you may have to add extra information about your **Access Point Name** (APN), Access Point Username and Access Point Password for authentication purposes. If you are unsure about these settings, please contact your mobile service provider and/or SIM card provider. However, most providers do not require this information to be entered.

---

**Note:** The RG191+LTE gateway comes with a preinstalled Truphone SIM card:

Navigate to <https://iot.truphone.com> to register and activate your SIM card.

Select a data plan that meets your data needs for your application. This is a subscription plan.

Enter Truphone's APN: **iot.truphone.com** in the APN field and save the configuration to start the cellular service. This requires a reboot.

**\*\* Cellular must be enabled in order to utilize the cellular feature.**

2. If your SIM card is protected, you should add your **PIN** and/or **PUK** code where needed (**otherwise leave these fields empty**). Reference the SIM card and/or mobile service provider documentation for more details on the necessary settings to configure.

---

**Note:** The RG191+LTE gateway comes with a preinstalled Truphone SIM card which, once registered and activated following the link above, does **NOT** require a PIN and/or PUK code by default.

If using the preinstalled Truphone SIM card, leave these fields blank.

**\*\* Cellular must be enabled in order to utilize the cellular feature.**

3. Choose a **Roaming option**. By default, roaming is enabled, and in most cases, it is recommended. For Roaming there are two options available – **Allowed** and **Disallowed**. When roaming is Disallowed, your network preference is restricted to home-only; no resources from other operator's network will be used in that case.
4. Apply your settings by clicking on the **Save Configuration** button and **reboot** the gateway when requested.

## 5.3 Advance Settings – Alternative DNS Server Configuration

Select the Advanced Modem Configuration page by clicking the **Advanced Settings** menu item in the side menu of the Cellular view (Figure 17)

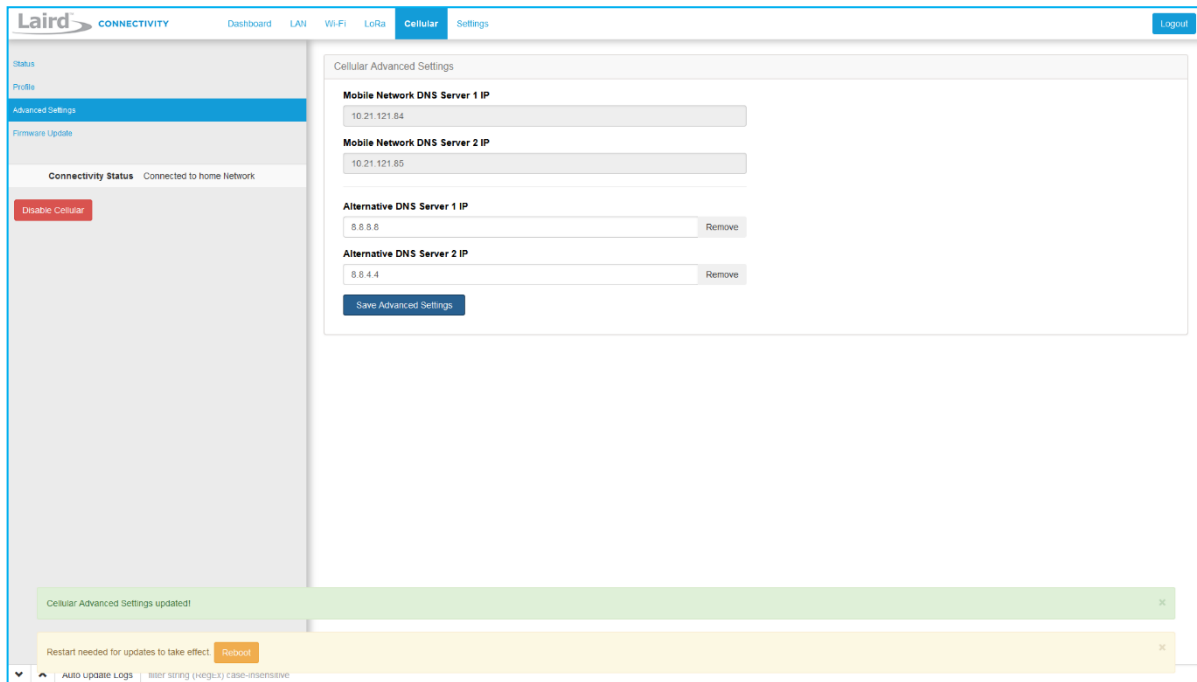

Figure 17: Cellular Advance Settings page

This page will provide information about Cellular’s DNS Server(s) assigned by your service provider.

Furthermore, you will find the option to set your own DNS Server(s) if needed.

In most cases this is not required. However, not all service providers hand out DNS Server(s) by default. Also, there are situations where you may want to overwrite the existing configuration. For example, if the DNS Server(s) do not perform well or when it is required by your application.

Apply your settings by clicking on the **Save Advanced Settings** button and **reboot** the gateway when requested.

---

**Note:** If **Mobile Network DNS Server 1 IP** and/or **Mobile Network DNS Server 2 IP** fields are empty Cellular is either disabled or your service provider does not provide them.

Your **Alternative DNS Server 1 IP** and **Alternative DNS Server 2** will be only used when there is no Ethernet and Wi-Fi connection available / configured.

---

## 6 LAN CONNECTION SETUP

The LAN menu allows selections for configuration and status of the IPv4/IPv6 wired network. The current status of the IPv4 network is also displayed. To access this section, click **LAN** in the page menu.

### 6.1 IPv4 Configuration

The first page for configuring the Ethernet LAN connection is the IPv4 Configuration page. There are two basic modes of operation – DHCP and Static. These are selected in the IP Address Acquisition Method drop-down box (Figure 18). The gateway factory default setting is DHCP.

Figure 18: IPv4 Configuration page

- **DHCP** – When in DHCP mode, all settings are provided by the DHCP server. All configuration settings (except IP Address Acquisition Method) are greyed out. IP values provided by DHCP are displayed but cannot be changed.
- **Static** – When the IP Address Acquisition Method is set to static, all IP settings are fixed and saved in the device. The external Gateway IP address is optional and may be left blank. DNS Server IP addresses are also optional. Zero, one, or two DNS servers may be specified.

### 6.2 IPv6 Configuration

Select the IPv6 configuration by clicking the IPv6 menu item in the side menu of the LAN view (Figure 18). The IPv6 configuration settings are shown below.

There are two fully supported modes for IPv6 addressing:

- **DHCP** – In DHCP mode, all settings are provided through communication with an IPv6 server on the network.
- **Auto** – In auto mode, you have the option of selecting the auto DHCP method (either stateless or SLAAC). At this time, IPv6 static mode is only partially supported.

Figure 19: IPv6 Configuration page

## 6.3 Advanced View

Select the advanced view by clicking the Advanced menu item in the LAN sidebar (Figure 20). The Advanced view shows all network information provided by the Wi-Fi module in the gateway. Depending on the settings of the network and the gateway, not all settings may apply to the current mode of operation. This view is intended to support advanced users in troubleshooting their network.

The screenshot displays the 'Advanced' view of the LAN configuration. The sidebar on the left shows the 'Advanced' menu item selected. The main content area is divided into two sections: 'Wired LAN Status IPv4' and 'Wired LAN Status IPv6'. Each section contains a table of network parameters.

| Wired LAN Status IPv4 |                   |
|-----------------------|-------------------|
| IP Address Method     | dhcp              |
| IP Address            | 10.16.122.12      |
| IPv4 Enabled          | true              |
| Netmask               | 255.255.254.0     |
| Ext Gateway IP        | 10.16.120.1       |
| Broadcast IP          | 10.16.123.255     |
| Client MAC Address    | AA:BB:CC:DD:EE:FF |
| DNS 1 IP              | 10.16.5.160       |
| DNS 2 IP              | 8.8.8.8           |

| Wired LAN Status IPv6 |   |
|-----------------------|---|
| IP Address Method     | static                                    |
| IP 1                  | fe80::c2ee:40ff:fe29:3643/64 Scope:Link   |
| IP 2                  | fe80::c2ee:40ff:fe29:3584/64 Scope:Global |
| IPv6 Enabled          | true                                      |
| Auto DHCP Method      | stateless                                 |
| Ext Gateway IP        | fda8::0005                                |

Figure 20: Advanced view

## 7 Wi-Fi CONNECTION SETUP

By default, the gateway's Wi-Fi radio is not configured to connect to a Wi-Fi network. The user must access the web interface on the gateway via the Ethernet interface to setup the Wi-Fi connection.

To setup a Wi-Fi connection, click the **Wi-Fi** tab in the main menu (Figure 21).

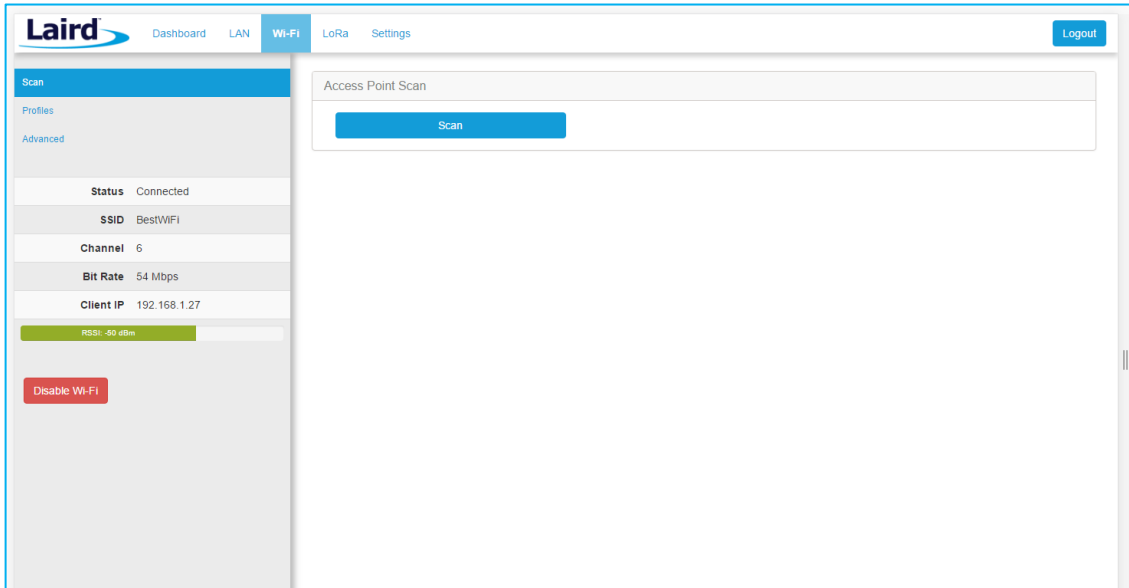

Figure 21: Wi-Fi connection setup

In the sidebar on the left, you can navigate to various Wi-Fi pages and see the status of the Wi-Fi interface. There is also a button to enable/disable the Wi-Fi radio.

### 7.1 Use Scan to Add a Profile

To use the scan function to add a profile, follow these steps:

1. **Connect to a Wi-Fi network** – click **Scan** to scan for nearby Wi-Fi networks. Scanning continues until you click **Stop** or click on one of the listed scan results (Figure 22).

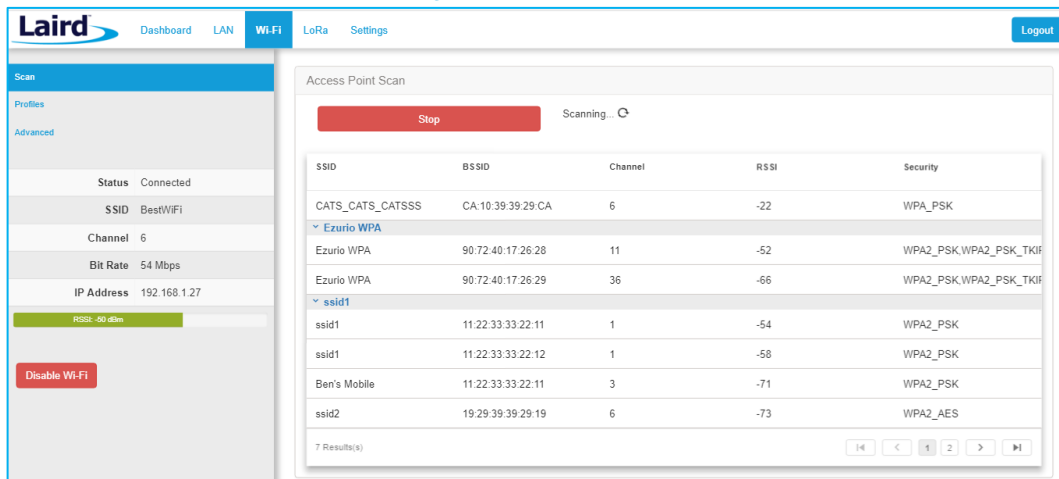

Figure 22: Scan function

2. Click on the applicable scan result.

3. In the Wi-Fi profile window, enter the appropriate credential information for your chosen Wi-Fi network (Figure 23).

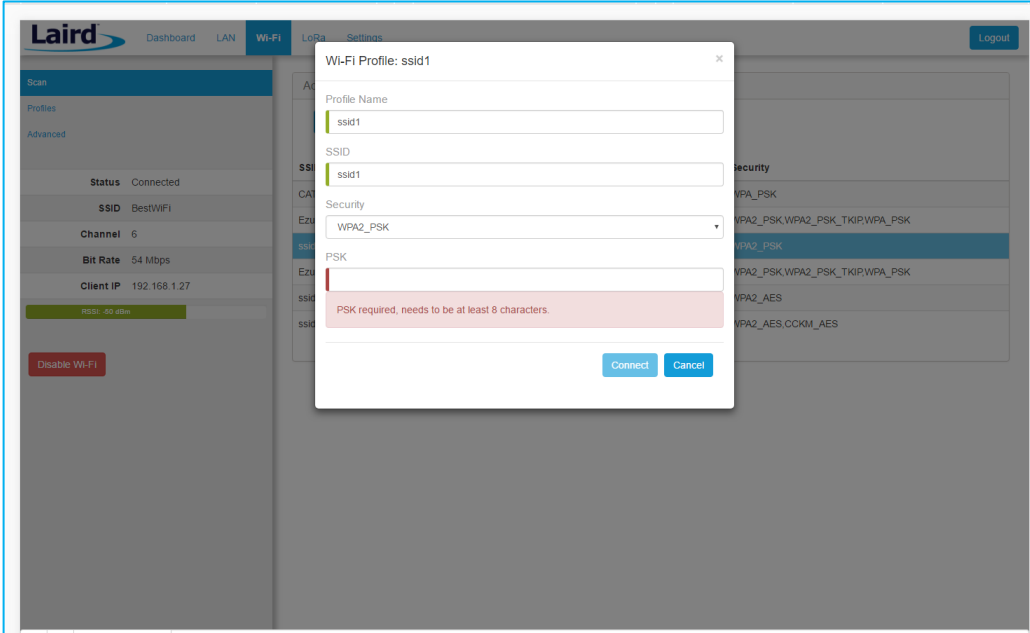

Figure 23: Wi-Fi profile window

## 7.2 Manually Adding a Profile

To add a Wi-Fi network profile manually, follow these steps:

1. Click the **LAN** button in the main menu, then click the **Profiles** button in the left menu. This page is useful for adding a hidden Wi-Fi network that is not broadcasting its SSID (Figure 24).

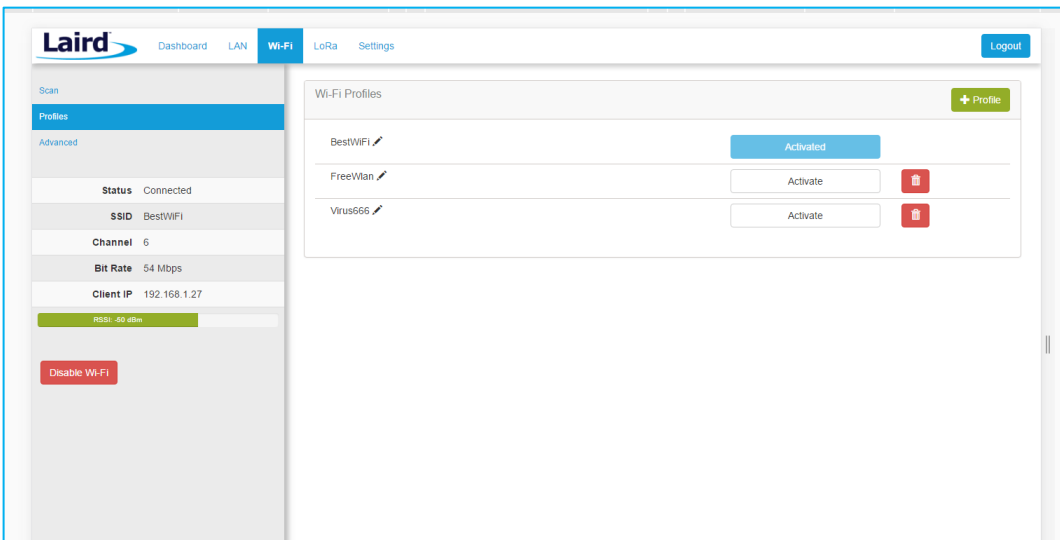

Figure 24: Wi-Fi profiles page

The profile page shows all Wi-Fi profiles that are saved in the gateway. You can add, activate, or delete the profiles shown on this page.



2. Click **+ Profile** to display the Wi-Fi profile dialog (Figure 25).

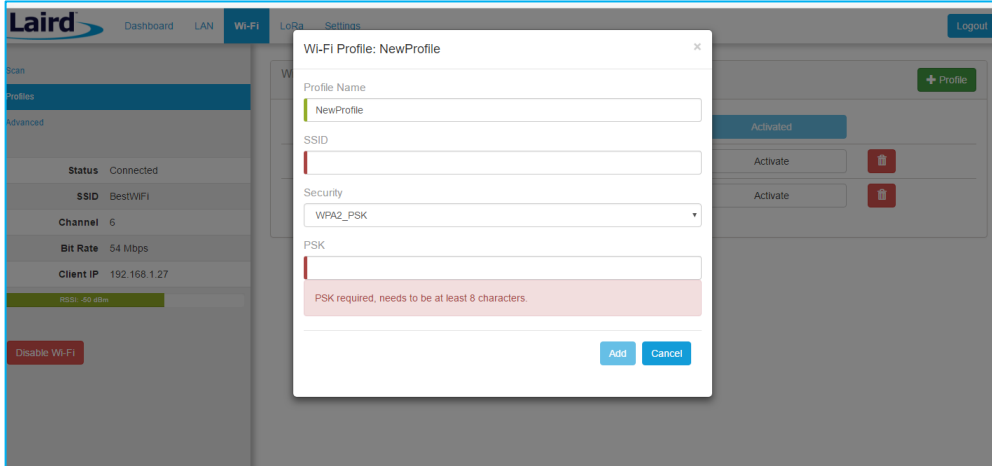

Figure 25: Wi-Fi profile dialog

3. Enter the appropriate information for the new profile.
4. Click **Add**.

### 7.3 Wi-Fi Advanced Page

The Wi-Fi advanced page shows more detailed information about the Wi-Fi radio status and allows the user to configure the Quick Config AP mode password (Figure 26).

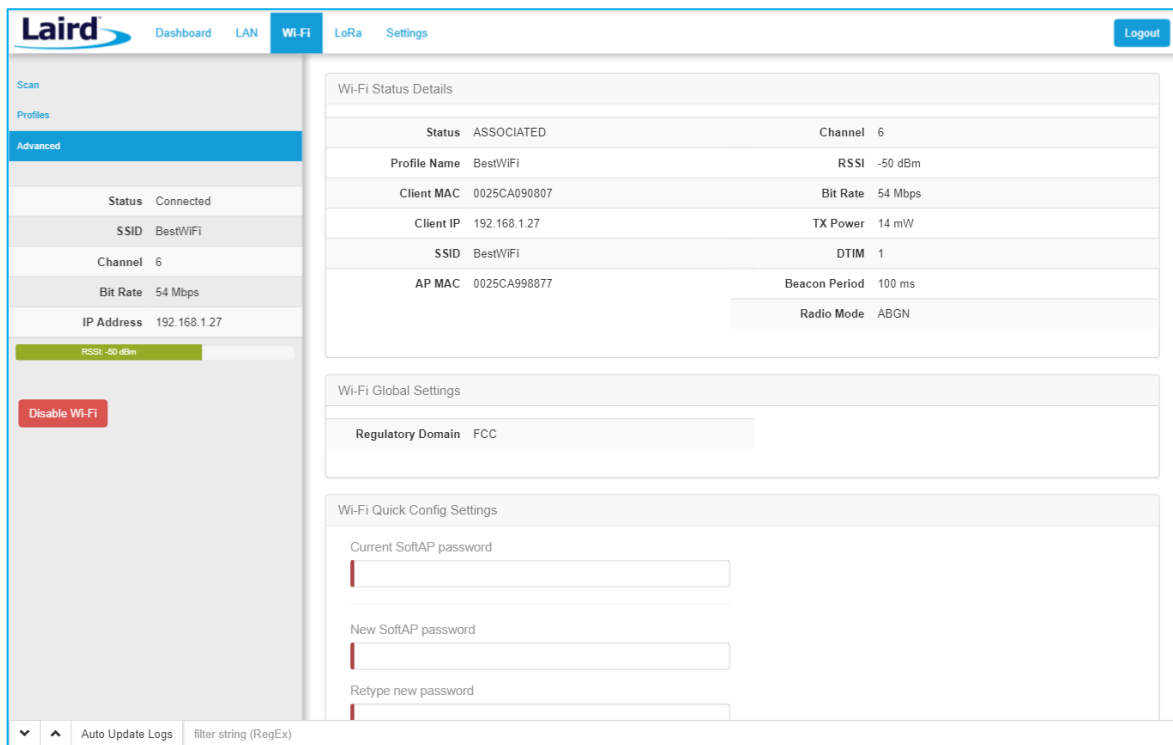

Figure 26: Wi-Fi Advanced page

## 8 LoRa CONNECTION SETUP

The side panel for the LoRa Gateway allows selections for configuration and status of the LoRa network card. The status of the LoRa Network is also displayed (Figure 27).

**Note:** The LoRa Region Code is displayed here. Be sure that the gateway you are operating matches the region in which you are operating it.

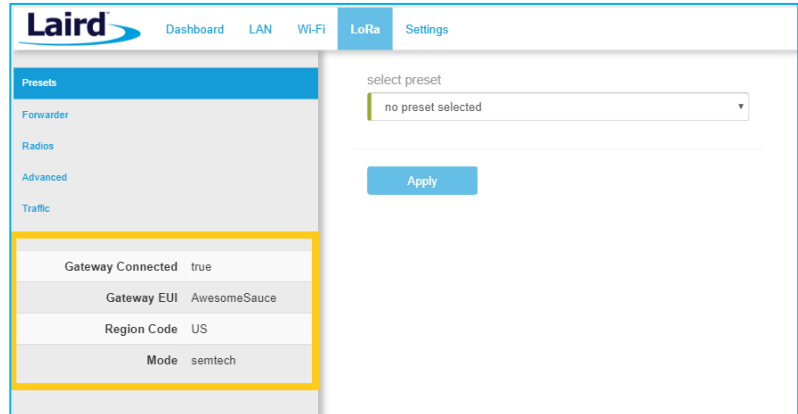

Figure 27: LoRa connection setup page

The Gateway ID (also known as the gateway DevEUI), is used to uniquely identify the RG1xx gateway. It is required when registering the gateway on a LoRa network server. The gateway EUI is also printed on the bottom label of the gateway, with the label *M2 EUI* or *DevEUI*.



Figure 28: Gateway label (Standard GW – Left, AS923 & AU915 Region Supported/Latest Version – Right)

### 8.1 Using Presets

The Sentrius™ RG1xx contains multiple preset configurations for connecting to a third-party server or as the basis for a private network. These presets configure the forwarder and the channel plan.

To apply a preset configuration, follow these steps:

1. Click the **LoRa** tab in the main menu. The default page of the LoRa menu is the **Presets** page (also accessible in the left side menu of the LoRa pages).
2. Select the preset from the drop down. Information about this preset is displayed in a panel to the right (Figure 29).

- Click **Apply** to apply the preset configuration. After a few moments, a green confirmation appears on the bottom of the page.

**Note:** After applying a preset, further changes can be made on the other screens. Some presets use a custom forwarder and may not be modified.

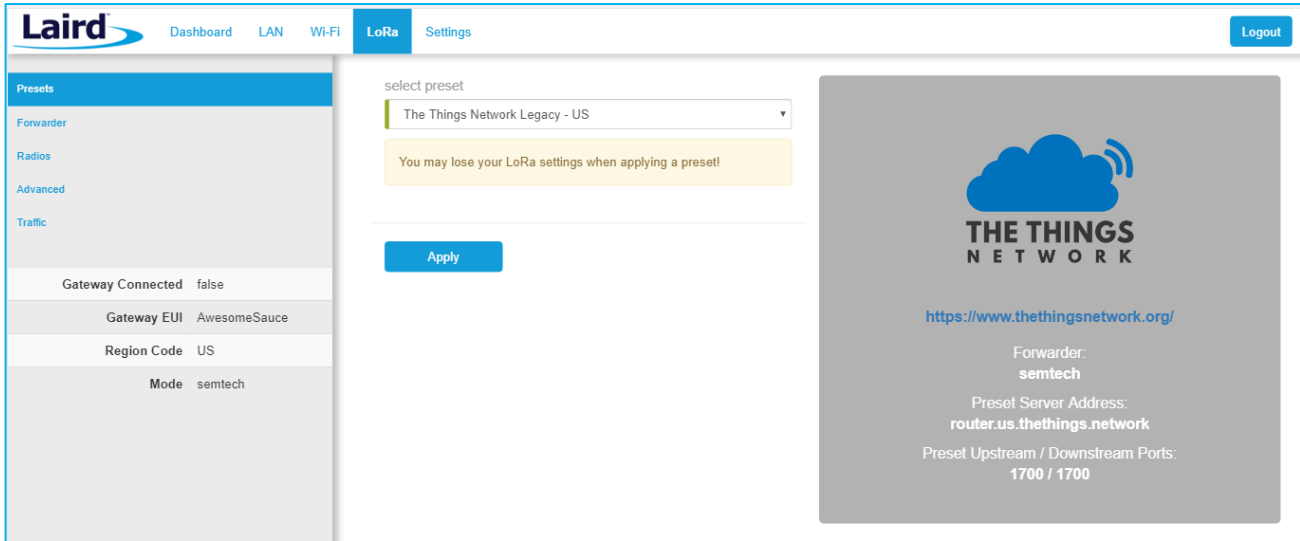

Figure 29: Selecting a preset configuration

## 8.2 Semtech Basic Station

Semtech's Basic Station replaces most other forwarders that were included in prior releases of the gateway. Basic station uses secure web sockets to communicate with the LoRa Network Server. It also has the capability to connect to a CUPS server to allow the device to configure the LNS connection remotely. All configuration settings beyond this are handled by the Lora Network Server. This includes the channel plan. An appropriate channel plan must be selected in the LNS that corresponds to the region of operation for your specific gateway.

### 8.2.1 Mode

The forwarder page allows configuration of the packet forwarder. The mode allows the user to change to different packet forwarders.

### 8.2.2 Servers

The user must enter in a valid LNS server to allow for operation as a packet forwarder. The CUPS servers are optional but should be kept blank if you do not want to communicate with the CUPS servers to provision the LNS certificates.

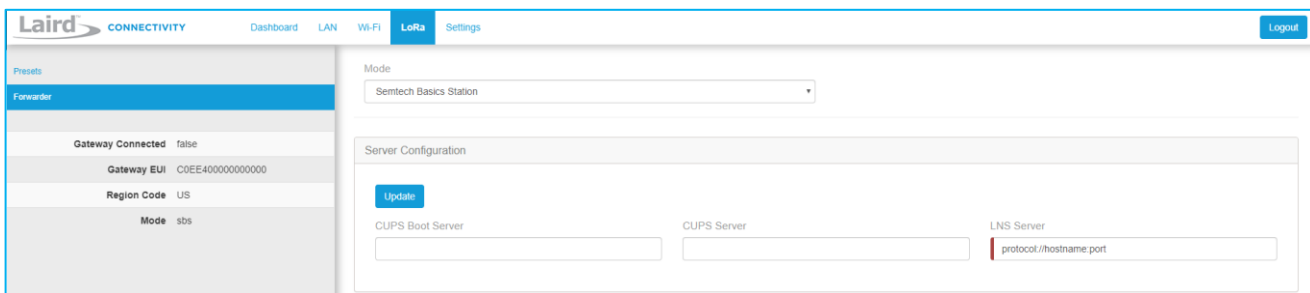

Figure 30: LNS server

## 8.2.3 Certificates

Each of the three servers has a set of certificates used to authenticate the server to the gateway and the other way around. It is possible to function in a mode where only the server is authenticated with the gateway in which case you would only install the server certificate.

To select a certificate, follow these steps:

1. Click **Choose File**.
2. Select the desired .pem file and press upload.

You can optionally select to upload your client certificate and key files when necessary.

All files can be uploaded at once with one click of the Upload Certificate button. After upload the Basic Station restarts and should attempt to connect to the server. You may also delete the certificates for each server by pressing **Delete Certificate**. This clears out all three files at once for the server. The text box indicates which files are already present.

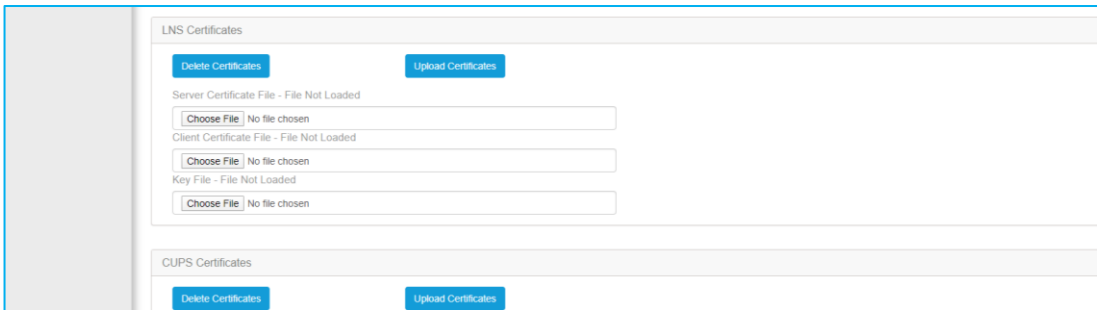

Figure 31: Certificate selection

## 8.2.4 Connection Status

### 8.2.4.1 LoRa View

The status of the connection to the LNS is shown on the sidebar when in the LoRa view.

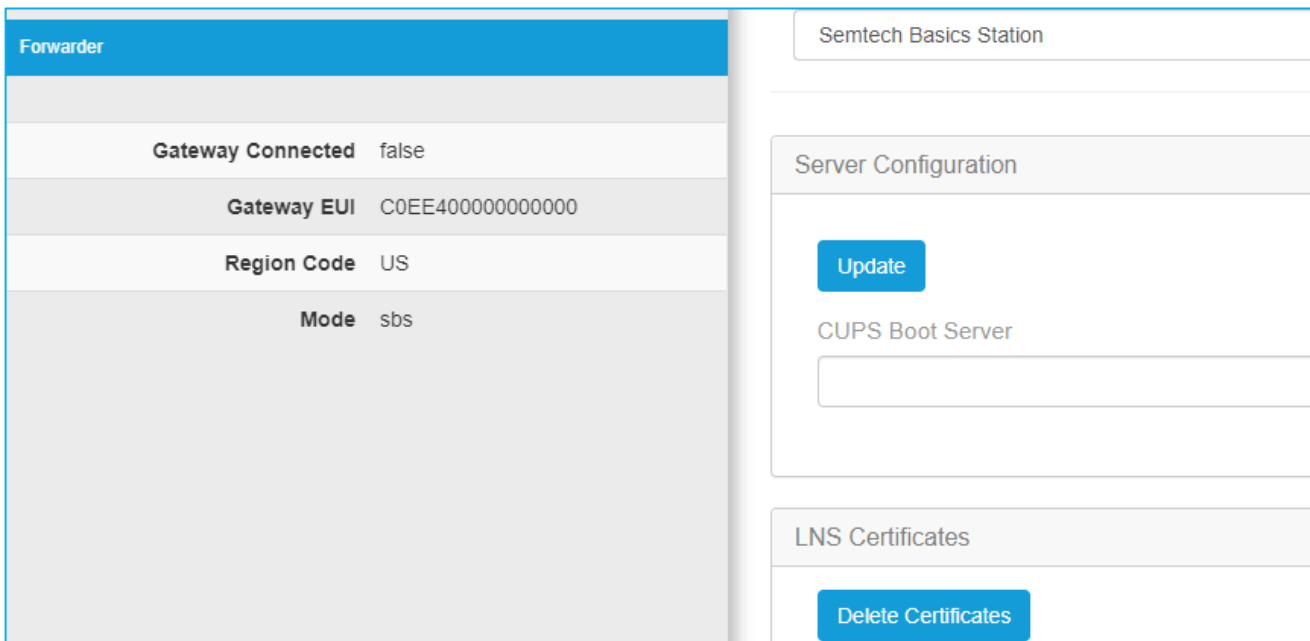

Figure 32: LoRa view

### 8.2.4.2 Dashboard View

In the Dashboard view, the status is shown with a circle that will be green when connected and black when disconnected.

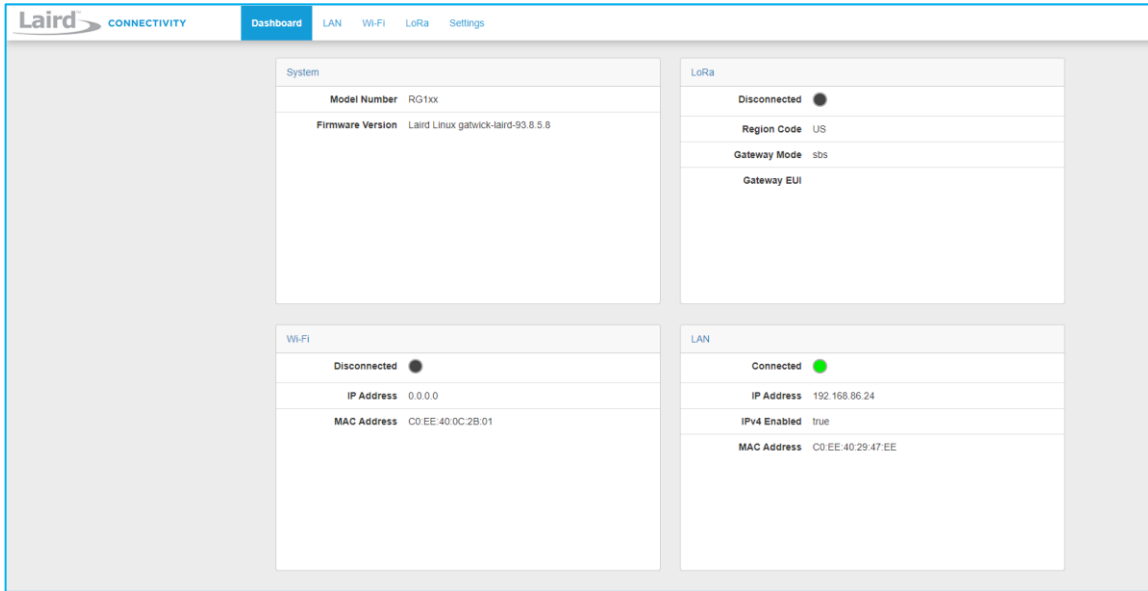

Figure 33: Dashboard view

## 8.3 Senet

Senet provides two modes of operation: Senet DEV and Senet RAN. In Senet DEV mode the web UI is enabled. **When in Senet RAN mode the Web UI is disabled and the only way out of that mode is by performing a factory reset** (see Factory Reset section). After a factory reset, you must contact Senet to be able to reconnect the gateway with the same EUI.

## 8.4 Semtech Legacy UDP Forwarder

Click **Forwarder** in the left-hand menu of the LoRa pages to access the Forwarder settings.

### 8.4.1 Mode

The forwarder page allows configuration of the packet forwarder. The mode allows the user to change to different packet forwarders.

### 8.4.2 Configuration

The configuration changes based on what packet forwarder is used.

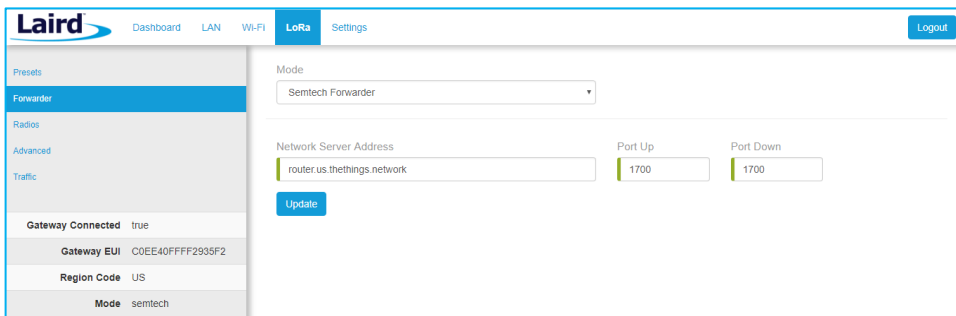

Figure 34: Semtech packet forwarder configuration

### 8.4.3 Radios

The radio page provides configuration of the radios and channels. The LoRa card has two radios (Radio 0 and Radio 1). This interface allows advanced users to change radio and channel assignments within the allowed range per the gateway region. Depending on the forwarder being used, the radio configuration may not be available.

#### 8.4.3.1 Channel Plan Graphic

At the top of the Radios page is a graphic representation of the full bandwidth range, channels, and radios. This graphic is different for gateways operating in US mode and EU mode.

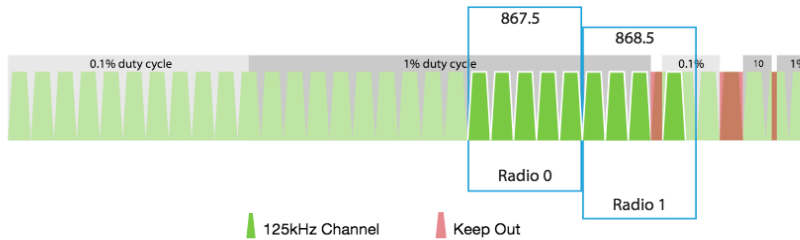

Figure 35: Channel plan graphic

#### 8.4.3.2 Radio Center Frequencies

Each radio is assigned a center frequency. Channels are then assigned to each radio and given an offset from the center (Figure 36).

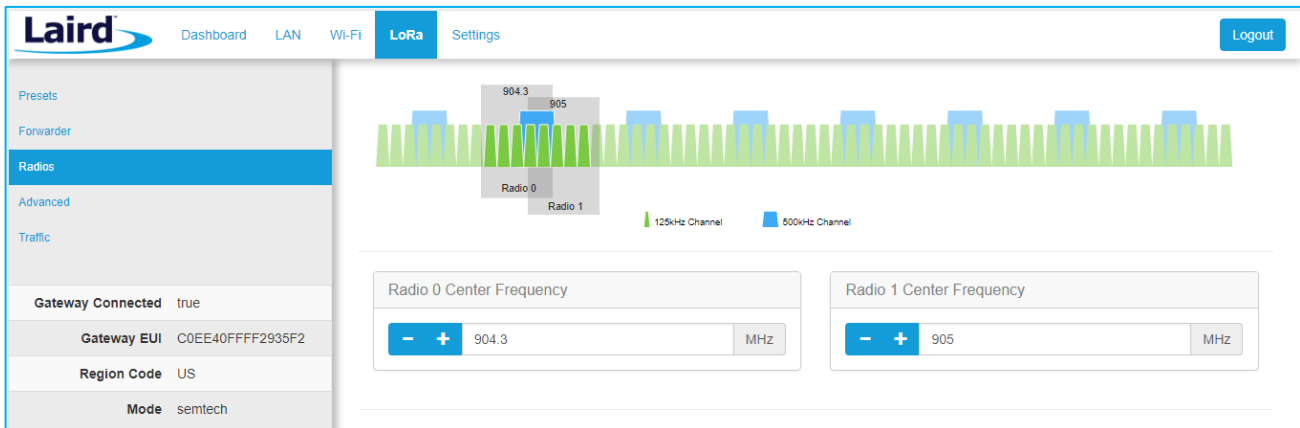

Figure 36: Channel assignments

#### 8.4.3.3 Channels

Channels are enabled and assigned to either radio. Each radio can have up to five channels assigned to it.

The channel's frequency is an offset of its radio's center frequency. For most channels with a 125-kHz bandwidth, the offset can be -0.4 to +0.4 MHz.

LoRa STD and FSK channels have configurable bandwidth. For these channels, when operating in 250-kHz or 500-kHz bandwidth, the offset can be -0.3 to +0.3 MHz.

Each channel should be placed at least 200 kHz from any other channel, otherwise the channel's bandwidth overlaps. While this configuration still functions, there is wasted bandwidth. The interface displays a warning and marks each channel in red if they overlap (Figure 38). Channel configuration is shown in Figure 37.

| Enable Channel                                 | Radio   | Channels | Frequency |
|--|---------|----------|-----------|
| <input checked="" type="checkbox"/> Multi SF 0 | Radio 0 | - +      | 911.9 MHz |
| <input checked="" type="checkbox"/> Multi SF 1 | Radio 0 | - +      | 912.1 MHz |
| <input checked="" type="checkbox"/> Multi SF 2 | Radio 0 | - +      | 912.3 MHz |
| <input checked="" type="checkbox"/> Multi SF 3 | Radio 0 | - +      | 912.5 MHz |
| <input checked="" type="checkbox"/> Multi SF 4 | Radio 1 | - +      | 912.6 MHz |

Figure 37: Channels window

The screenshot shows the Laird LoRa Settings interface. On the left is a navigation menu with options like Presets, Forwarder, Radios, Advanced, and Traffic. The main area displays the LoRa settings. At the top, there's a frequency spectrum visualization showing two overlapping channels: Radio 0 at 904.3 MHz and Radio 1 at 905 MHz. Below this, there are input fields for 'Radio 0 Center Frequency' (904.3 MHz) and 'Radio 1 Center Frequency' (905 MHz). At the bottom, the 'Channels' table shows two channels: Multi SF 0 at 903.9 MHz and Multi SF 1 at 904 MHz. Both channels are highlighted in red, indicating they overlap, and each has a red warning icon.

| Enable Channel                                 | Radio   | Channels | Frequency |
|--|---------|----------|-----------|
| <input checked="" type="checkbox"/> Multi SF 0 | Radio 0 | - +      | 903.9 MHz |
| <input checked="" type="checkbox"/> Multi SF 1 | Radio 0 | - +      | 904 MHz   |

Figure 38: Overlapping channels

### 8.4.3.4 LoRa Radio Card (US)

Gateways that operate in the US region should have a 500-kHz channel. In Figure 39, the allowed placement of these channels displays larger and blue.

If a 500-kHz channel is not configured, the interface displays a warning.

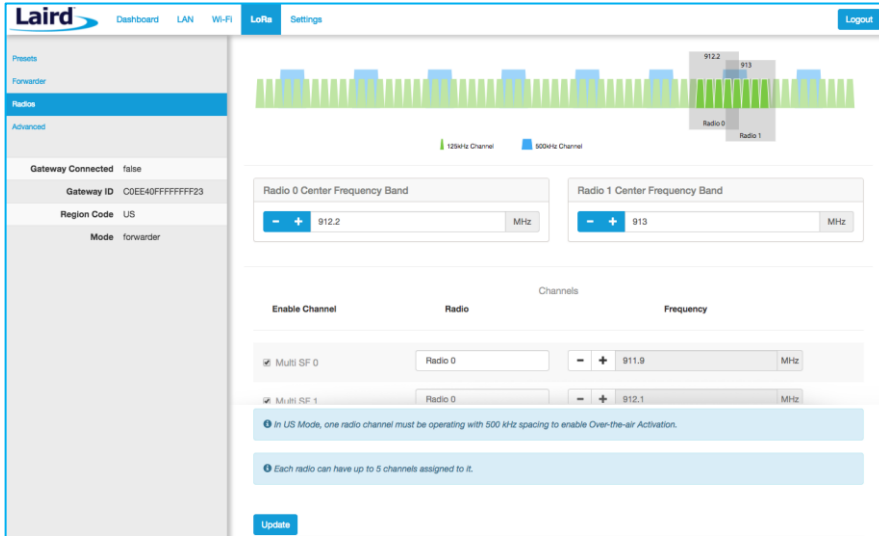

Figure 39: US region gateways

### 8.4.3.5 LoRa Radio Card (EU)

There are three mandatory channels for gateways that operate in the EU region. These channels are 868.1, 868.3, and 868.5.

The EU region bands have different duty cycles. This is indicated with a grey background box and label in Figure 40. A higher duty cycle allows higher throughput.

The EU region specifies *keep out* areas in the allowed frequencies. These are highlighted in red on the illustration. The interface displays a warning if a channel lies in a keep-out area.

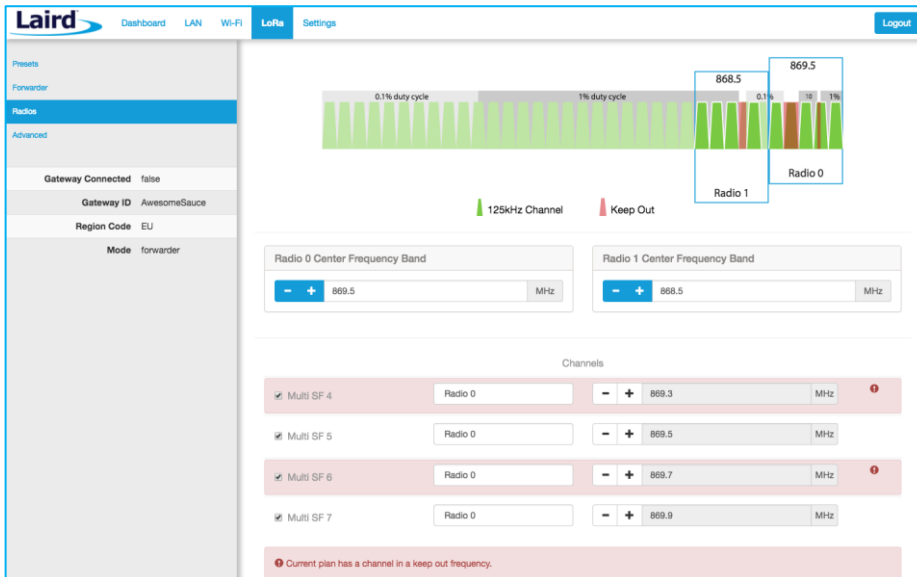
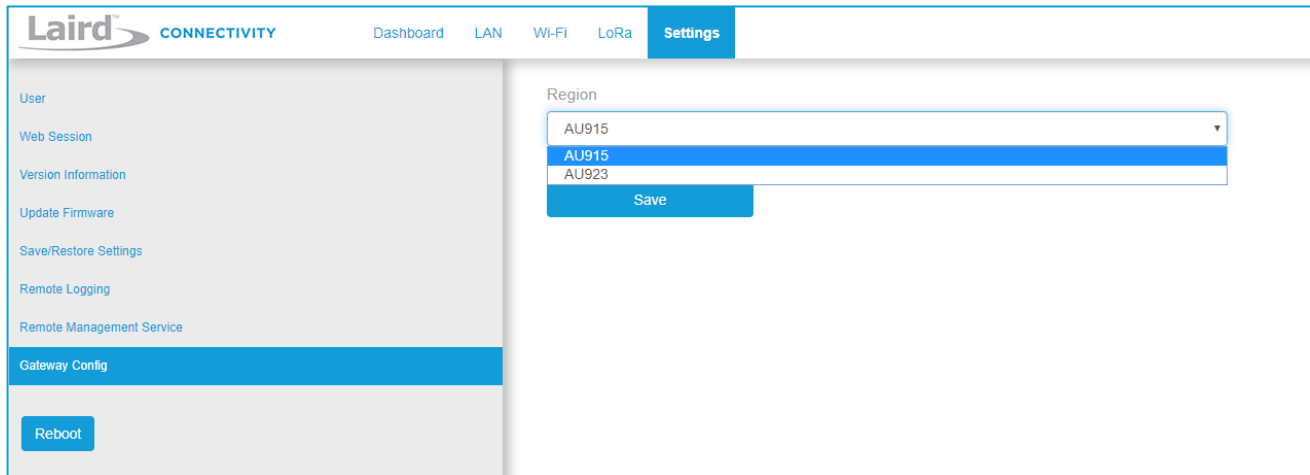

Figure 40: EU region gateways – keep out channels



## 8.4.4 LoRa Radio Card (Australia)

If the gateway is the Australia variant, the user may toggle between the AU915 and AU923 regions through the web UI on the gateway. A factory reset must be performed on the device after toggling between AU915 and AU923. No other regions are end-user selectable.



**Figure 41: Australia region selector**

### 8.4.4.1 AU915

The region code is AU915. This is not an AS923 region with no mandatory channel requirements. The firmware will restrict the operation to the legal regulatory limits for this region. These limits include frequency, duty cycle, dwell time, and power restrictions. If the network server requests to transmit in an illegal manner, the packet will be dropped. In the case of TX power, the TX power will be clipped to the highest allowable power if the requested power exceeds the legal limit for this region.

### 8.4.4.2 AU923

The region code is AU923. This is an AS923 region, therefore there are two mandatory channels: 923.2 and 923.4. The firmware will restrict the operation to the legal regulatory limits for this region. These limits include frequency, duty cycle, dwell time, and power restrictions. If the network server requests to transmit in an illegal manner, the packet will be dropped. In the case of TX power, the TX power will be clipped to the highest allowable power if the requested power exceeds the legal limit for this region.

## 8.4.5 LoRa Radio Card (New Zealand)

The region code is NZ. This is an AS923 region, therefore there are two mandatory channels: 923.2 and 923.4. The firmware will restrict the operation to the legal regulatory limits for this region. These limits include frequency, duty cycle, dwell time, and power restrictions. If the network server requests to transmit in an illegal manner, the packet will be dropped. In the case of TX power, the TX power will be clipped to the highest allowable power if the requested power exceeds the legal limit for this region.

## 8.4.6 LoRa Radio Card (Taiwan)

The region code is TW. This is an AS923 region, therefore there are two mandatory channels: 923.2 and 923.4. The firmware will restrict the operation to the legal regulatory limits for this region. These limits include frequency, duty cycle, dwell time, and power restrictions. If the network server requests to transmit in an illegal manner, the packet will be dropped. In the case of TX power, the TX power will be clipped to the highest allowable power if the requested power exceeds the legal limit for this region.

## 8.4.7 LoRa Radio Card (Hong Kong)

The region code is HK. This is an AS923 region, therefore there are two mandatory channels: 923.2 and 923.4. The firmware will restrict the operation to the legal regulatory limits for this region. These limits include frequency, duty cycle, dwell time, and power restrictions. If the network server requests to transmit in an illegal manner, the packet will be dropped. In the case of TX power, the TX power will be clipped to the highest allowable power if the requested power exceeds the legal limit for this region.

## 8.4.8 LoRa Radio Card (Singapore)

The region code is SG. This is an AS923 region, therefore there are two mandatory channels: 923.2 and 923.4. The firmware will restrict the operation to the legal regulatory limits for this region. These limits include frequency, duty cycle, dwell time, and power restrictions. If the network server requests to transmit in an illegal manner, the packet will be dropped. In the case of TX power, the TX power will be clipped to the highest allowable power if the requested power exceeds the legal limit for this region.

## 8.5 Advanced Configuration

The Advanced page provides additional configuration options for the specific forwarder.

The screenshot shows the 'Laird' web interface with the 'LoRa' settings page. The left sidebar contains navigation links for 'Presets', 'Forwarder', 'Radios', and 'Advanced'. The 'Advanced' section is active, displaying a table with the following data:

|                   |                   |
|-------------------|-------------------|
| Gateway Connected | false             |
| Gateway ID        | C0EE40FFFFFFFFF23 |
| Region Code       | US                |
| Mode              | forwarder         |

The main content area contains the following configuration options:

- logging level: Debug
- keep alive (seconds): 10
- push timeout (milliseconds): 100
- stat interval (seconds): 30
- forward crc valid:
- forward crc error:
- forward crc disabled:

Buttons for 'Update', 'Apply', and 'Download' are visible at the bottom of the configuration area.

Figure 42: Advanced configuration page

The current configuration may be saved as a JSON text file. This file can also be uploaded to restore the saved configuration. This feature is useful for configuring multiple gateways with the same configuration (Figure 43).

**Note:** If the forwarder settings contain credentials, these are not saved in the configuration file for security reasons. **The user must take care to set the appropriate credentials when restoring the saved configuration to a gateway.**

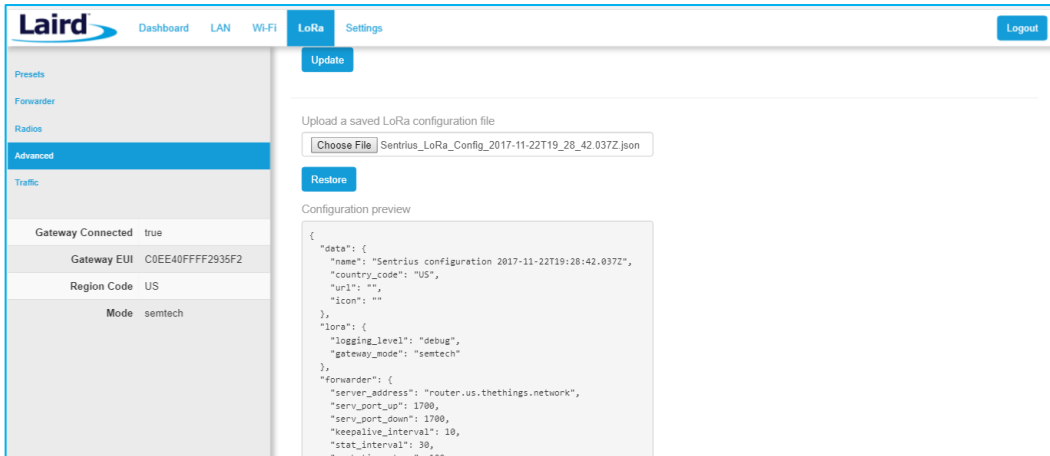

Figure 43: Current configuration file

## 8.6 Traffic

The traffic page is only available when using certain forwarders. When navigating to the traffic page, any recent traffic that has been seen by the gateway displays. To watch live traffic, click **Poll Traffic**. Traffic columns can be sorted, and filters can be applied to one column at a time.

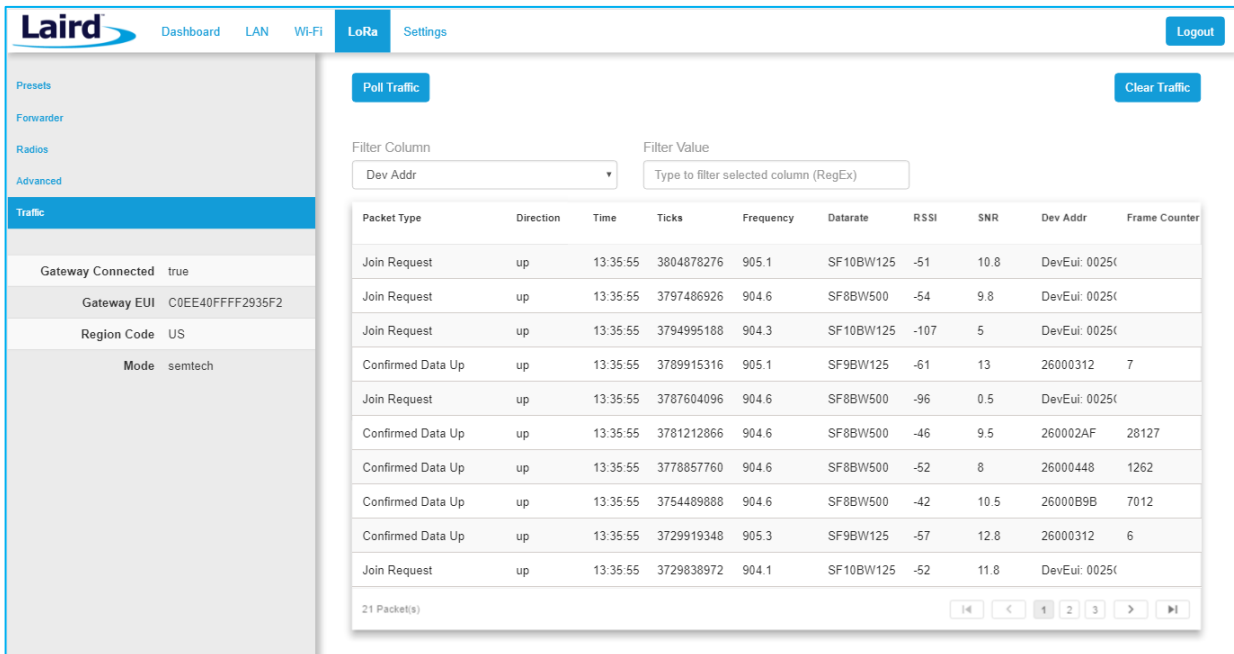

Figure 44: LoRa traffic

Clicking on a traffic row displays packet details.

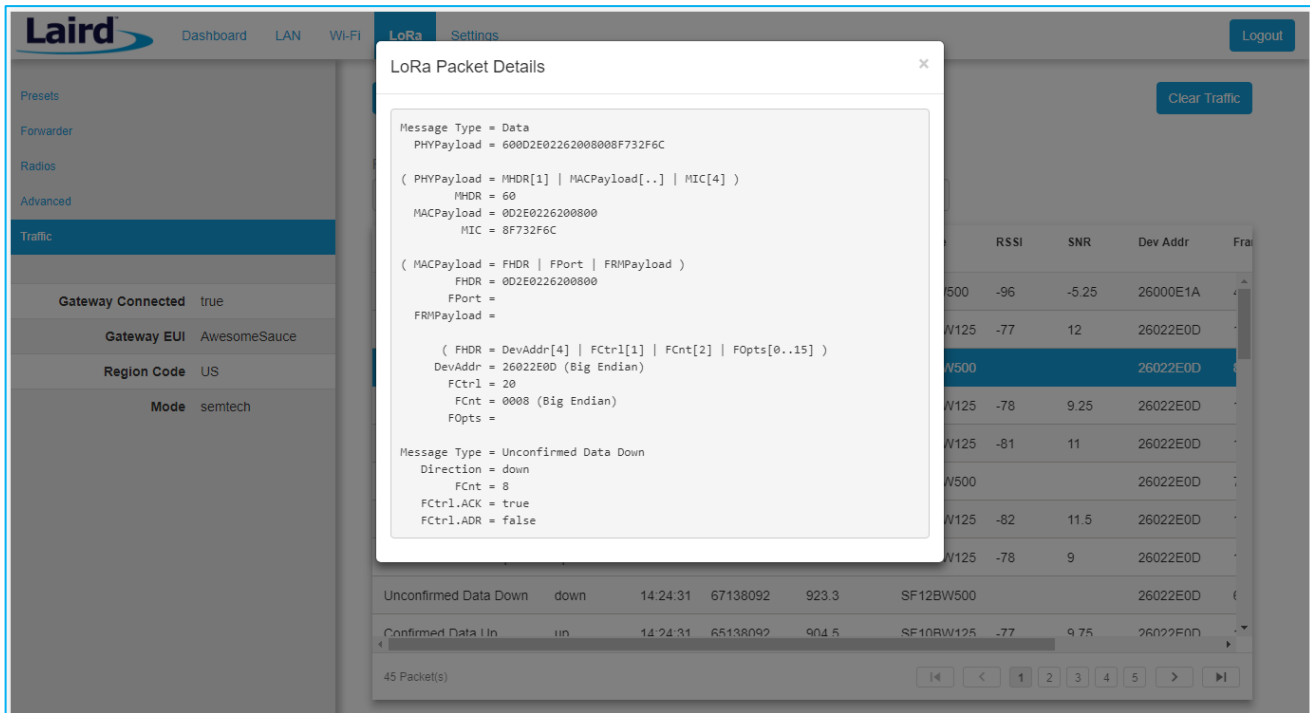

Figure 45: LoRa packet details

## 9 MANAGE THE GATEWAY

### 9.1 Changing Username and Password

To change the login credentials of the gateway, follow these steps:

1. In the main menu, click the **Settings** tab. Then in the left menu, click the **User** tab (Figure 46).
2. Enter the current password, and then the new desired username and password.
3. Click **Update**.

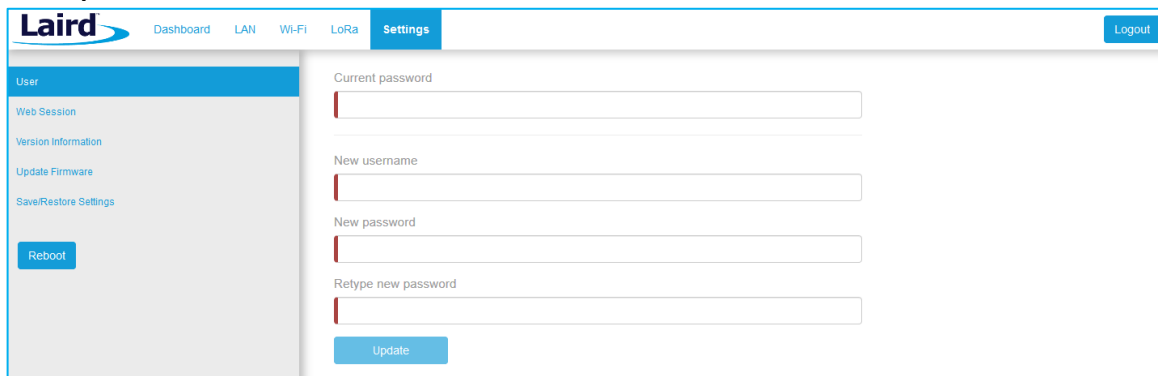

Figure 46: Change username and password

## 9.2 Web Session

The user can change the web session timeout. The web session timeout is the amount of time before the user will be warned and automatically logged out if there is no web activity. Activity is defined as navigating between pages, changing any settings, or polling LoRa traffic. The minimum time, and default, is 5 minutes and the maximum time is 60 minutes. When polling LoRa traffic, the time is set to the maximum of 60 minutes. When polling is stopped, the time out is set back to the saved setting.

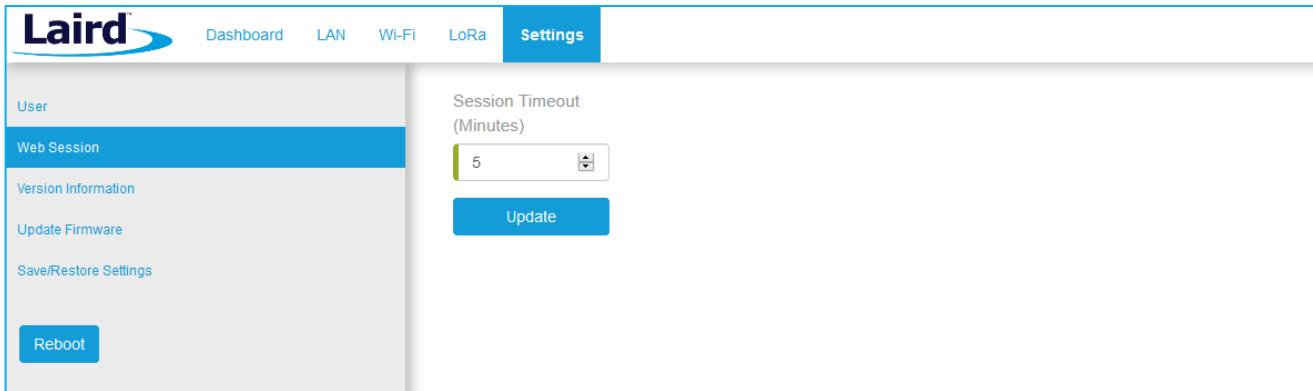

Figure 47: Change web session time out

## 9.3 Version Information

The **Settings > Version Information** page shows detailed software/firmware information of various components in the gateway.

The Build string is the overall firmware version for the gateway software package.

If a firmware update is available a New Build Available row is displayed.

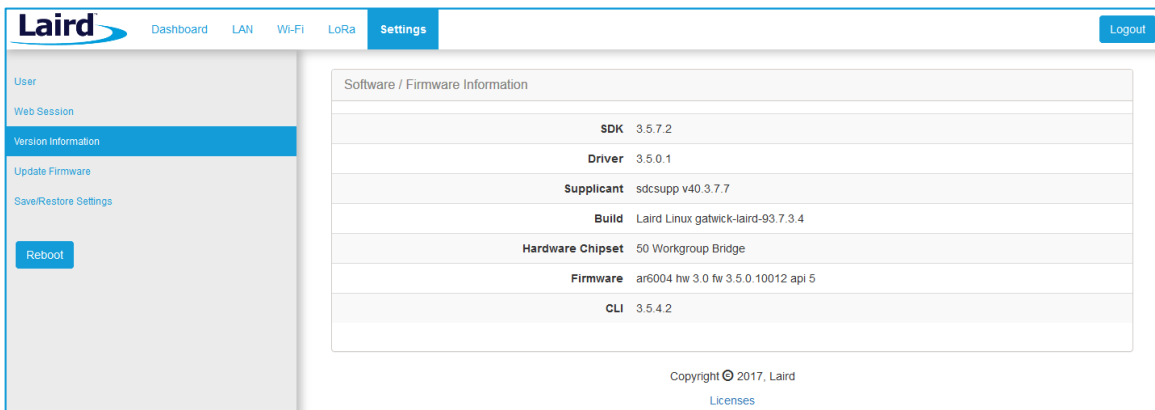

Figure 48: Version information

### 9.3.1 Modem Version Information

**Note:** This information is only available with the RG191+LTE hardware for the US market only, see [Ordering Information](#) for product part numbers.

The **Cellular > Status** page shows detailed software/firmware information of the cellular modem in the gateway. The **Firmware Revision** string is the firmware version for the modem software package.

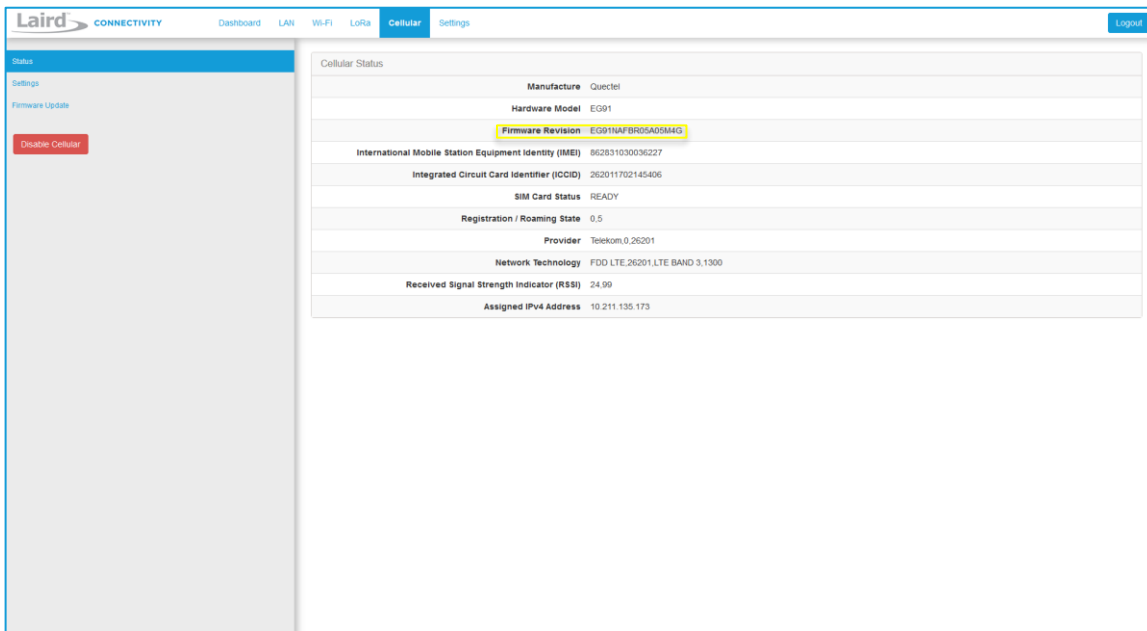

Figure 49: Modem Version information

## 9.4 Updating Gateway Firmware

To update the firmware in the gateway, follow these steps:

**Warning:** Updating the firmware **MAY** restore the gateway to factory default settings. We advise you to save/backup or make note of any settings the user does not wish to lose beforehand.

1. Click the **Settings** tab in the main menu. Then click **Update Firmware** in the left menu.
2. Enter the proper URL. Information about which URL is to be used can be found below.
3. Click **Start Update**.

The firmware update process downloads the firmware to the gateway and then flashes it.

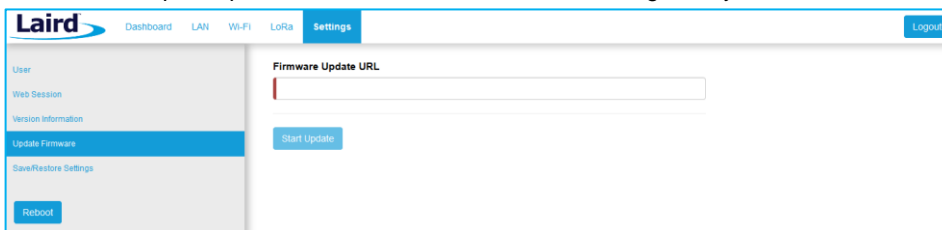

Figure 50: Updating gateway firmware window

During the firmware update, the progress displays as shown in (Figure 51).

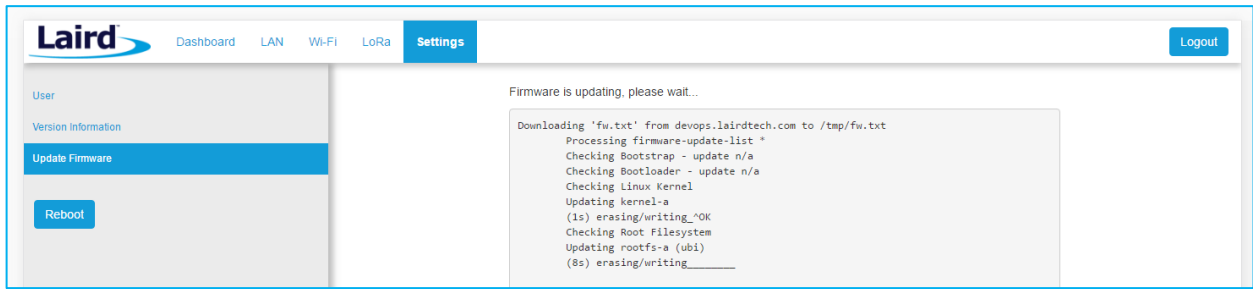

Figure 51: Progress indicator

- At the end of the update, you are prompted to reboot the gateway. Click **Reboot**. The gateway must be rebooted for the update to take effect (Figure 52).

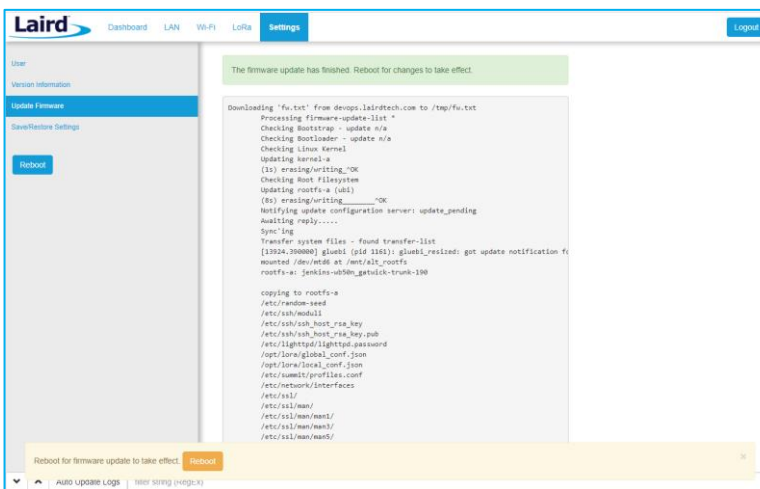

Figure 52: Reboot prompt

## 9.4.1 Firmware Update URLs

**IMPORTANT:** Please follow the instructions based on the firmware version **currently** running on the gateway.

### 9.4.1.1 93.7.1.13 (GA1) Firmware

If the gateway is running version **93.7.1.13** firmware the user should use this link to upgrade to the next version:

<https://www.lairdtech.com/products/rglxx-lora-gateway/firmware/GA1.1/fw.txt>

After updating with this link, the gateway will be running version 93.7.1.14. Follow the instructions for that version to update to the latest version of firmware.

### 9.4.1.2 93.7.1.14 Firmware

If the gateway is running version **93.7.1.14** firmware the user should use this link to upgrade to the next version:

<https://www.lairdtech.com/products/rglxx-lora-gateway/firmware/GA2.1/fw.txt>

After updating with this link, the gateway will be running version 93.7.2.10. Follow the instructions for that version to update to the latest version of firmware.

**WARNING:** This upgrade performs a factory reset on the gateway.

### 9.4.1.3 93.7.2.9 (GA2) Firmware

If the gateway is running version **93.7.2.9** firmware the user should use this link to upgrade to the next version:

<https://www.lairdtech.com/products/rglxx-lora-gateway/firmware/GA2.1/fw.txt>

After updating with this link, the gateway will be running version 93.7.2.10. Follow the instructions for that version to update to the latest version of firmware.

---

**WARNING:** This upgrade performs a factory reset on the gateway.

---

### 9.4.1.4 93.7.2.10 (GA2.1) Firmware

If the gateway is running version **93.7.2.10** firmware the user should use this link to upgrade to the latest version:

<https://www.lairdtech.com/products/rglxx-lora-gateway/firmware/newest/fw.txt>

**Note:** This requires users to manually update the URL!

### 9.4.1.5 93.7.3.4 (GA3) Firmware and Newer

GA3 firmware (93.7.3.x) and newer versions have a feature to automatically notify the user if new firmware is available and what link to download the firmware from.

#### 9.4.1.6 GA4 Firmware (93.8.4.28)

#### 9.4.1.7 GA4.1 Firmware (93.8.4.37)

#### 9.4.1.8 GA5 Firmware (93.8.5.18)

#### 9.4.1.9 GA5.1 Firmware (93.8.5.21)

#### 9.4.1.10 GA5.2 Firmware (93.8.5.25) - Engineering Release

#### 9.4.1.11 GA6 Firmware (93.9.6.12)

#### 9.4.1.12 GA6 Firmware (93.9.6.14) - Current and latest production release

<https://connectivity-firmware.s3.amazonaws.com/rglxx-lora-gateway/firmware/newest/fw.txt>

## 9.4.2 Cellular Modem Firmware Updates

---

**Note:** This update process is only available with the RG191+LTE hardware for the US market only, see [Ordering Information](#) for product part numbers.

---

From the **Cellular** tab, select the **Firmware Update** page by clicking Firmware Update menu item in the side menu of the Cellular view ([Figure 53](#)).

Verify the current firmware version of the modem by seeing section **Modem Version Information**. The initial production release firmware version of the modem is **EG91NAFBR05A05M4G** version **01.005.01.005**.

You can update the firmware of the integrated Cellular modem to the newest available version.

---

**Note:** **Modem firmware updates should ONLY be performed when something is not working, you are facing connection problems, or you have been instructed to do so by the Laird Connectivity support team.**

---

1. Before starting, please make sure that the Cellular Modem is turned on and you have restarted the Gateway.
2. Use a valid **Firmware HTTP(S) DFOTA (Delta Firmware Upgrade Over-the-air) Update URL** provide by Laird Connectivity, once an update is available it will be defined within this user guide.
3. Start the Firmware Update by clicking on button **Start DFOTA Update**. This may take a while.



4. Follow the onscreen instructions and, if requested, restart the Gateway to finish the process.

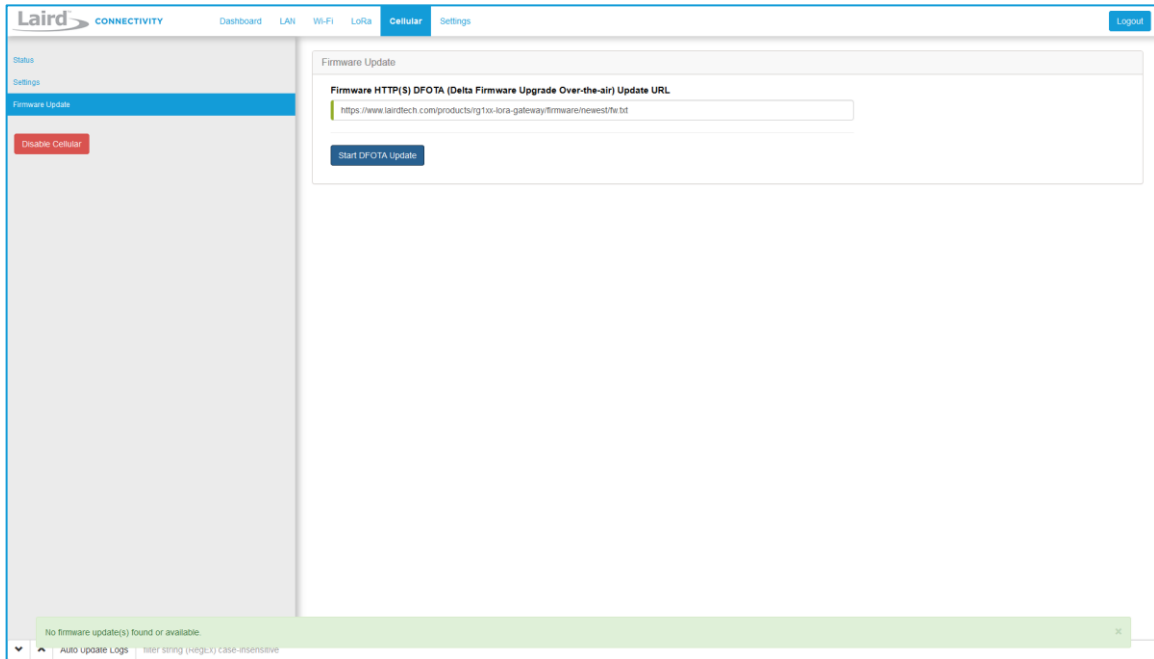

Figure 53: Cellular Firmware Update page

## 9.5 Save/Restore Settings

All the settings in the gateway can be saved and restored. This is useful for backing up all settings before a factory reset or firmware upgrade. Settings are saved to a JSON file and can be restored on another gateway.

**Note:** Any security related settings like credentials and security certificates are not saved in the JSON file for security reasons. That means security-related settings cannot be restored onto a separate gateway. Security related settings are only saved on the current gateway and can be restored on the same gateway.

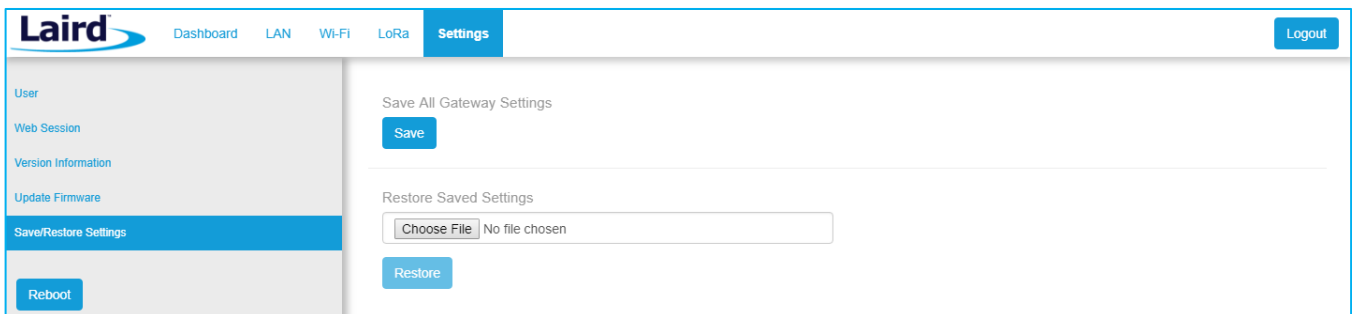

Figure 54: Save/Restore settings

After restoring settings, the gateway must be rebooted for changes to take effect.

## 9.6 Remote Management

The gateway can be managed remotely via TR-069. It requires an externally hosted Auto Configuration Server (ACS) to use this feature. This allows a system administrator to access the gateways without needing physical access to the gateway or access behind a firewall. The gateway will periodically initiate connections with the ACS allowing a user to remotely update LoRa configuration settings, update firmware, download logs, etc.

### 9.6.1 Configuring the Gateway for Remote Management

The user must point the device to your external ACS. This is done under **Settings > Remote Management Service**. This is a one-time setting that is preserved across firmware updates.

The URL must be updated, including the port number. In a standard ACS installation, this is usually **port 7547** but that can vary. Consult your ACS provider for the URL, port number, username, and password. The username and password fields are for connections initiated by the gateway. Not for connections initiated by the ACS. The parameter key is optional. Press the update button when all parameters are correctly entered.

The screenshot shows the 'Settings' page in the Laird Connectivity web interface. The 'Remote Management Service' section is active. It contains the following fields and options: 'URL' (text input with 'http://18.218.16.40:7547/'), 'Parameter Key' (text input), 'Periodic Enable' (checkbox, checked), 'Periodic Interval' (text input with '120'), 'Periodic Time' (text input with '0001-01-01T00:00:00Z'), 'Username' (text input), and 'Password' (text input). An 'Update' button is located at the bottom of the form. A 'Reboot' button is visible in the 'Gateway Config' section on the left sidebar.

Figure 55: Save/Restore settings

### 9.6.2 Updating Firmware Remotely

This works much like it does with the web User Interface (UI). When the system administrator has a new firmware release to load, they will update the `InternetGatewayDevice.Laird.GatewayManagement.Versions.FirmwareUpdateURL`. The value is the link to download the firmware. This link always points to a `fw.txt` file. Once that is done, the gateway will respond with success, and download the firmware in the background. A remote user would then poll for `InternetGatewayDevice.Laird.GatewayManagement.Versions.FirmwareUpdateStatus` to be set to "1" indicating that the firmware was successfully downloaded and is ready to reboot to switch to the new firmware. The system administrator would then issue the TR-069 "Reboot" command to reboot the device. After the reboot, the gateway will check in again and be running the new version. Note that settings (including remote management) are preserved across a firmware update.

### 9.6.3 Configuration File Upload

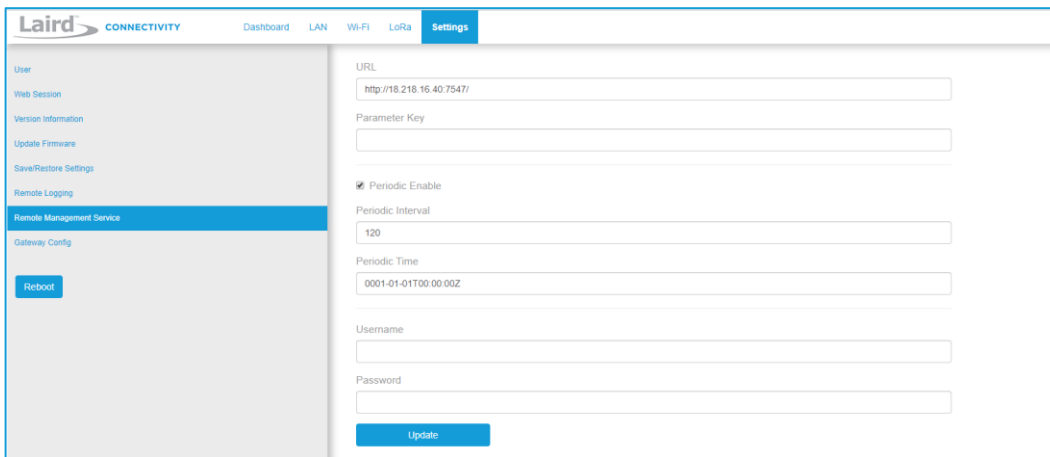
#### 9.6.3.1 Configuration Files

Configuration files and certificates can be uploaded to the device. These configuration files are called 'vendor configuration files' in TR-069 terminology. An ACS can be commanded to push these to a device or group of devices. The vendor configuration file can change a number of settings in bulk. It is useful to (re)configure a batch of new devices in the field. These settings include, LAN, WiFi, and LoRa radio settings (including the channel plan and other radio settings).

A strategy to deploy configurations to the field is to modify a unit locally to the way you want it. Download the configuration file via TR-069 from a locally configured gateway, then upload that generated configuration file to be pushed to all the units once the system administrator is satisfied that all of the settings are correct on the 'golden unit'. A download is initiated by the ACS with the type "3 Vendor Configuration File", and an upload is also initiated by the ACS with the type "3 Vendor Configuration File". The ACS will not put a file extension on the downloaded file. It is a compressed tarball (.tar.gz) file.

See the documentation for your ACS to determine how to initiate the "3 Vendor Configuration File" upload command.

## 9.6.4 Configuration File Download

### 9.6.4.1 Log File

Initiate a download by the ACS with type 2 *Vendor Log File*. This returns the log data. The same log data that can be obtained by the web interface. It is viewable with a text editor.

### 9.6.4.2 Configuration Files

The device configuration can be downloaded by the ACS with type 3 *Vendor Configuration File*. This allows a user to configure a device locally to their specification, then save the settings for distribution to a larger group of deployed units. This file will include LoRa settings, Wi-Fi settings, and IP settings. This includes the channel plan used by the Semtech UDP packet forwarder. This file can be uploaded to deployed gateways to update their configuration to match the device that was updated locally. It is always good practice to locally test any configuration changes you make, so that you know it works the way you want it to before deploying the changes to more units deployed in the field. See the documentation for your ACS to determine how to initiate the 3 *Vendor Configuration File* download command.

## 9.6.5 The Sentrius Gateway's TR-069 Data Model

The following tables show all of the parameters supported by the gateway along with a description of each. Each entry in the table is designated as read (R), write (W), or object (O). The items designated as objects are nodes in the data model. All parameters are designated with an R, W, or both.

The root of the data model is InternetGatewayDevice.

### 9.6.5.1 InternetGatewayDevice.Laird.DeviceInfo

**Table 2: InternetGatewayDevice.Laird.DeviceInfo**

| Parameter Name                                       | R/W | Description  | Input Data |
|--|-----|--|------------|
| <b>InternetGatewayDevice.DeviceInfo</b>              | O   | Device info node   | N/A        |
| InternetGatewayDevice.DeviceInfo.SpecVersion         | R   | Version of the TR-069 spec referenced by this implementation                                 | N/A        |
| InternetGatewayDevice.DeviceInfo.ProvisioningCode    | R   | Code set by the ACS to indicate completed provisioning                                       | N/A        |
| InternetGatewayDevice.DeviceInfo.Manufacturer        | R   | Device manufacturer  | N/A        |
| InternetGatewayDevice.DeviceInfo.ManufacturerOUI     | R   | MAC address OUI value for the manufacturer   | N/A        |
| InternetGatewayDevice.DeviceInfo.ProductClass        | R   | Product type   | N/A        |
| InternetGatewayDevice.DeviceInfo.SerialNumber        | R   | Unique value assigned to each device at production   | N/A        |
| InternetGatewayDevice.DeviceInfo.HardwareVersion     | R   | Hardware version   | N/A        |
| InternetGatewayDevice.DeviceInfo.SoftwareVersion     | R   | Software version   | N/A        |
| <b>InternetGatewayDevice.DeviceInfo.MemoryStatus</b> | O   | MemoryStatus node  | N/A        |
| InternetGatewayDevice.DeviceInfo.MemoryStatus.Total  | R   | Total system memory  | N/A        |
| InternetGatewayDevice.DeviceInfo.MemoryStatus.Free   | R   | Total free system memory   | N/A        |
| InternetGatewayDevice.DeviceInfo.UpTime              | R   | Total up time  | N/A        |
| InternetGatewayDevice.DeviceInfo.DeviceLog           | R   | Unused in our implementation. Request an upload of type 4 <i>Vendor Log File</i> via the ACS | N/A        |
| InternetGatewayDevice.DeviceInfo.ModelName           | R   | Model name   | N/A        |

### 9.6.5.2 InternetGatewayDevice.Laird.ActiveProfileSettings

**Table 3: InternetGatewayDevice.Laird.ActiveProfileSettings**

| Parameter Name  | R/W | Description                                  | Input Data   |
|---|-----|--|--|
| <b>InternetGatewayDevice.Laird.ActiveProfileSettings</b>      | O   | Active Wi-Fi profile node                    | N/A  |
| InternetGatewayDevice.Laird.ActiveProfileSettings.ProfileName | R/W | Wi-Fi profile name (not SSID)                | String representing the profile name   |
| InternetGatewayDevice.Laird.ActiveProfileSettings.SSID        | R/W | Wi-Fi network SSID                           | String representing the SSID   |
| InternetGatewayDevice.Laird.ActiveProfileSettings.PSK         | W   | Wi-Fi network preshared key                  | String representing the PSK  |
| InternetGatewayDevice.Laird.ActiveProfileSettings.ClientName  | R/W | Wi-Fi network client name                    | A string representing name client name.  |
| InternetGatewayDevice.Laird.ActiveProfileSettings.TxPower     | R   | TX power                                     | A numeric value representing TX power  |
| InternetGatewayDevice.Laird.ActiveProfileSettings.AuthType    | R/W | Wi-Fi network authentication type            | open, shared, or eap   |
| InternetGatewayDevice.Laird.ActiveProfileSettings.EAPType     | R/W | Wi-Fi network EAP type                       | leap, eap-fast, peap-mschapv2, eap-tls, peap-tls   |
| InternetGatewayDevice.Laird.ActiveProfileSettings.WEPTType    | R/W | Wi-Fi network WEP type                       | none, wep, wep-eap, psk, tkip, wpa2-psk, wpa2-aes, cckm-tkip, cckm-aes, wpa-psk-aes, wpa-aes |
| InternetGatewayDevice.Laird.ActiveProfileSettings.Mode        | R/W | Wi-Fi network mode                           | BGN  |
| InternetGatewayDevice.Laird.ActiveProfileSettings.Powersave   | R   | Is power save enabled                        | off,max,fast   |
| InternetGatewayDevice.Laird.ActiveProfileSettings.PSPDelay    | R   | Power save delay                             | A value 10 - 500 in milliseconds   |
| InternetGatewayDevice.Laird.ActiveProfileSettings.Username    | R/W | Username used by some authentication methods | A string representing the username   |
| InternetGatewayDevice.Laird.ActiveProfileSettings.Password    | W   | Password used by some authentication methods | A string representing the password   |

### 9.6.5.3 InternetGatewayDevice.Laird.WIFIGlobalSettings

**Table 4: InternetGatewayDevice.Laird.WIFIGlobalSettings**

| Parameter Name   | R/W | Description                             | Input Data |
|--|-----|---|------------|
| <b>InternetGatewayDevice.Laird.WIFIGlobalSettings</b>          | O   | Hardcoded Wi-Fi settings in the gateway | N/A        |
| InternetGatewayDevice.Laird.WIFIGlobalSettings.UAPSD           | R   | Hardcoded Wi-Fi settings in the gateway | N/A        |
| InternetGatewayDevice.Laird.WIFIGlobalSettings.WMM             | R   | Hardcoded Wi-Fi settings in the gateway | N/A        |
| InternetGatewayDevice.Laird.WIFIGlobalSettings.AChannelSet     | R   | Hardcoded Wi-Fi settings in the gateway | N/A        |
| InternetGatewayDevice.Laird.WIFIGlobalSettings.AuthServerType  | R   | Hardcoded Wi-Fi settings in the gateway | N/A        |
| InternetGatewayDevice.Laird.WIFIGlobalSettings.AutoProfile Off | R   | Hardcoded Wi-Fi settings in the gateway | N/A        |
| InternetGatewayDevice.Laird.WIFIGlobalSettings.BGChannelSet    | R   | Hardcoded Wi-Fi settings in the gateway | N/A        |
| InternetGatewayDevice.Laird.WIFIGlobalSettings.BeaconMissTime  | R   | Hardcoded Wi-Fi settings in the gateway | N/A        |
| InternetGatewayDevice.Laird.WIFIGlobalSettings.CCXFeatures     | R   | Hardcoded Wi-Fi settings in the gateway | N/A        |
| InternetGatewayDevice.Laird.WIFIGlobalSettings.CertificatePat  | R   | Hardcoded Wi-Fi settings in the gateway | N/A        |
| InternetGatewayDevice.Laird.WIFIGlobalSettings.DateCheck       | R   | Hardcoded Wi-Fi settings in the gateway | N/A        |
| InternetGatewayDevice.Laird.WIFIGlobalSettings.DefaultAdhocCh  | R   | Hardcoded Wi-Fi settings in the gateway | N/A        |
| InternetGatewayDevice.Laird.WIFIGlobalSettings.DFSChannels     | R   | Hardcoded Wi-Fi settings in the gateway | N/A        |
| InternetGatewayDevice.Laird.WIFIGlobalSettings.FIPSPMode       | R   | Hardcoded Wi-Fi settings in the gateway | N/A        |
| InternetGatewayDevice.Laird.WIFIGlobalSettings.IgnoreNullSSID  | R   | Hardcoded Wi-Fi settings in the gateway | N/A        |
| InternetGatewayDevice.Laird.WIFIGlobalSettings.PMKCaching      | R   | Hardcoded Wi-Fi settings in the gateway | N/A        |
| InternetGatewayDevice.Laird.WIFIGlobalSettings.ProbeDelay      | R   | Hardcoded Wi-Fi settings in the gateway | N/A        |

| Parameter Name  | R/W | Description                             | Input Data |
|---|-----|---|------------|
| InternetGatewayDevice.Laird.WIFIGlobalSettings.RegulatoryDomain | R   | Hardcoded Wi-Fi settings in the gateway | N/A        |
| InternetGatewayDevice.Laird.WIFIGlobalSettings.RoamPeriodMs     | R   | Hardcoded Wi-Fi settings in the gateway | N/A        |
| InternetGatewayDevice.Laird.WIFIGlobalSettings.RoamTrigger      | R   | Hardcoded Wi-Fi settings in the gateway | N/A        |
| InternetGatewayDevice.Laird.WIFIGlobalSettings.RTSThreshold     | R   | Hardcoded Wi-Fi settings in the gateway | N/A        |
| InternetGatewayDevice.Laird.WIFIGlobalSettings.ScanDFSTime      | R   | Hardcoded Wi-Fi settings in the gateway | N/A        |
| InternetGatewayDevice.Laird.WIFIGlobalSettings.TTLInnerMethod   | R   | Hardcoded Wi-Fi settings in the gateway | N/A        |

#### 9.6.5.4 InternetGatewayDevice.Laird.LORASettings

**Table 5: InternetGatewayDevice.Laird.LORASettings**

| Parameter Name  | R/W | Description   | Input Data   |
|---|-----|---|--|
| <b>InternetGatewayDevice.Laird.LORASettings</b>               | O   | The LoRa settings for the gateway.  | N/A  |
| InternetGatewayDevice.Laird.LORASettings.EUI                  | R   | This is the unique identifier for your gateway.   | N/A  |
| InternetGatewayDevice.Laird.LORASettings.Mode                 | R/W | This is the chosen packet forwarder type.   | semtech, sbs   |
| InternetGatewayDevice.Laird.LORASettings.Region               | R/W | This is the region of operation your gateway is configured to. It is only writable one time, and is set before leaving the factory. Attempting to change this after it is locked, will result in no change and an error being returned. | The following strings representing country codes: MY, SG, TW, HK, AU915, AU923, NZ, US, EU |
| InternetGatewayDevice.Laird.LORASettings.STServer             | R/W | This is the URL for the network server when using the legacy Semtech UDP packet forwarder.  | The URL of the server.   |
| InternetGatewayDevice.Laird.LORASettings.STPortUp             | R/W | This is the port used by the Semtech packet forwarder   | A 2-4 digit port number.   |
| InternetGatewayDevice.Laird.LORASettings.STPortDown           | R/W | This is the port used by the Semtech packet forwarder   | A 2-4 digit port number.   |
| InternetGatewayDevice.Laird.LORASettings.STKeepAlive          | R/W | This is the keep alive timeout used by the Semtech packet forwarder.  | A value in milliseconds  |
| InternetGatewayDevice.Laird.LORASettings.STPushTimeout        | R/W | This is the push timeout used by the Semtech packet forwarder.  | A value in milliseconds  |
| InternetGatewayDevice.Laird.LORASettings.STStatInterval       | R/W | This is the stat interval used by the Semtech packet forwarder.   | A value in milliseconds  |
| InternetGatewayDevice.Laird.LORASettings.STForwardCRCValid    | R/W | This determines if packets with CRC errors are forwarded.   | true, false  |
| InternetGatewayDevice.Laird.LORASettings.STForwardCRCError    | R/W | This determines if packets with CRC errors are forwarded.   | true, false  |
| InternetGatewayDevice.Laird.LORASettings.STForwardCRCDisabled | R/W | This determines if packets with CRC errors are forwarded.   | true, false  |
| InternetGatewayDevice.Laird.LORASettings.SBSCUPSBootURL       | R/W | This is the CUPS-Boot URL used by Basic Station.  | A string representing the URL of the CUPS-Boot server.                                     |
| InternetGatewayDevice.Laird.LORASettings.SBSCUPSURL           | R/W | This is the CUPS URL used by Basic Station.   | A string representing the URL of the CUPS server.  |
| InternetGatewayDevice.Laird.LORASettings.SBSLNSURL            | R/W | This is the URL to the LNS server used by Basic Station.  | A string representing the URL of the LNS server.   |
| InternetGatewayDevice.Laird.LORASettings.SBSStatus            | R   | This is the status of the connection to the LNS server. 0 - Disconnected, 1 - Connected.  | N/A  |
| InternetGatewayDevice.Laird.LORASettings.RadioConfig          | R   | This is the radio settings including channel plan used by the Legacy Semtech UDP packet forwarder.  | N/A – This can be updated via vendor config file upload.                                   |

### 9.6.5.5 InternetGatewayDevice.Laird.LANSettings

**Table 6: InternetGatewayDevice.Laird.LANSettings**

| Parameter Name  | R/W | Description  | Input Data |
|---|-----|--|------------|
| <b>InternetGatewayDevice.Laird.LANSettings</b>              | O   | This node contains the LAN settings. These are not writeable as parameters | N/A        |
| InternetGatewayDevice.Laird.LANSettings.IPv4                | O   | IPv4 settings  | N/A        |
| InternetGatewayDevice.Laird.LANSettings.IPv4.DNSServer1     | R   | The first DNS server   | N/A        |
| InternetGatewayDevice.Laird.LANSettings.IPv4.DNSServer2     | R   | The second DNS server  | N/A        |
| InternetGatewayDevice.Laird.LANSettings.IPv4.DeviceAddr     | R   | Gateway IP address   | N/A        |
| InternetGatewayDevice.Laird.LANSettings.IPv4.NetMask        | R   | The netmask  | N/A        |
| InternetGatewayDevice.Laird.LANSettings.IPv4.Broadcast      | R   | The broadcast IP address   | N/A        |
| InternetGatewayDevice.Laird.LANSettings.IPv4.ExtGWIP        | R   | Gateway IP address (not necessarily external)                              | N/A        |
| InternetGatewayDevice.Laird.LANSettings.IPv4.IPMethod       | R   | IP mode (DHCP or static)   | N/A        |
| InternetGatewayDevice.Laird.LANSettings.IPv6                | O   | IPv6 settings  | N/A        |
| InternetGatewayDevice.Laird.LANSettings.IPv6.DeviceAddr     | R   | IPv6 address   | N/A        |
| InternetGatewayDevice.Laird.LANSettings.IPv6.Mask           | R   | IPv6 net mask  | N/A        |
| InternetGatewayDevice.Laird.LANSettings.IPv6.IPMethod       | R   | IPv6 mode  | N/A        |
| InternetGatewayDevice.Laird.LANSettings.IPv6.AutoDHCPMethod | R   | IPv6 auto DHCP mode  | N/A        |

### 9.6.5.6 InternetGatewayDevice.Laird.GatewayManagement

**Table 7: InternetGatewayDevice.Laird.GatewayManagement**

| Parameter Name   | R/W | Description   | Input Data  |
|--|-----|---|---|
| <b>InternetGatewayDevice.Laird.GatewayManagement</b>                     | O   | Version information and how to initiate a firmware update | N/A   |
| InternetGatewayDevice.Laird.GatewayManagement.Password                   | W   | Set the password.   | A string indicating a space separated value:<br>current_password<br>new_password                    |
| InternetGatewayDevice.Laird.GatewayManagement.ProvisioningComplete       | R   | Has provisioning been completed.                          | 1 = completed, 0 = not completed  |
| <b>InternetGatewayDevice.Laird.GatewayManagement.Versions</b>            | O   | Contains version information                              | N/A   |
| InternetGatewayDevice.Laird.GatewayManagement.Versions.SDK               | R   | SDK version   | N/A   |
| InternetGatewayDevice.Laird.GatewayManagement.Versions.Driver            | R   | Driver package version                                    | N/A   |
| InternetGatewayDevice.Laird.GatewayManagement.Versions.Supplicant        | R   | Wi-Fi supplicant version                                  | N/A   |
| InternetGatewayDevice.Laird.GatewayManagement.Versions.Build             | R   | Build version   | N/A   |
| InternetGatewayDevice.Laird.GatewayManagement.Versions.HardwareChipset   | R   | Hardware chipset  | N/A   |
| InternetGatewayDevice.Laird.GatewayManagement.Versions.Firmware          | R   | Wi-Fi firmware version                                    | N/A   |
| InternetGatewayDevice.Laird.GatewayManagement.Versions.CLI               | R   | SDC CLI version   | N/A   |
| InternetGatewayDevice.Laird.GatewayManagement.Versions.FirmwareUpdateURL | R/W | URL to point to a new firmware version                    | String with the URL pointing to a <i>fw.txt</i> file with the firmware hosted on an external server |

| Parameter Name  | R/W | Description  | Input Data |
|---|-----|--|------------|
| InternetGatewayDevice.Laird.GatewayManagement.Versions.FirmwareUpdateStatus | R   | Status of the firmware update (1 = complete, 0 = not complete) | N/A        |

### 9.6.5.7 InternetGatewayDevice.Laird.SavedProfileSettings

**Table 8: InternetGatewayDevice.Laird.SavedProfileSettings**

| Parameter Name   | R/W | Description  | Input Data   |
|--|-----|--|--|
| <b>InternetGatewayDevice.Laird.SavedProfileSettings</b>        | O   | Node to modify saved profile settings                      | N/A  |
| InternetGatewayDevice.Laird.SavedProfileSettings.ListProfiles  | R   | List of all gateway Wi-Fi profiles                         | N/A  |
| InternetGatewayDevice.Laird.SavedProfileSettings.ProfileName   | R/W | Wi-Fi profile alias that the user wants to modify          | String representing the profile name   |
| InternetGatewayDevice.Laird.SavedProfileSettings.AddProfile    | R/W | Adds a new profile   | String representing the profile name   |
| InternetGatewayDevice.Laird.SavedProfileSettings.DeleteProfile | R/W | Deletes a profile  | String representing the profile name   |
| InternetGatewayDevice.Laird.SavedProfileSettings.SSID          | R/W | SSID for the selected Wi-Fi profile                        | String representing the SSID   |
| InternetGatewayDevice.Laird.SavedProfileSettings.PSK           | R/W | PSK for the selected Wi-Fi profile                         | String representing the PSK  |
| InternetGatewayDevice.Laird.SavedProfileSettings.ClientName    | R/W | Client name for the selected Wi-Fi profile                 | String representing name client name   |
| InternetGatewayDevice.Laird.SavedProfileSettings.TxPower       | R/W | TX power for the selected Wi-Fi profile                    | A numeric value representing TX power  |
| InternetGatewayDevice.Laird.SavedProfileSettings.AuthType      | R/W | Authentication type for the selected Wi-Fi profile         | open, shared, or eap   |
| InternetGatewayDevice.Laird.SavedProfileSettings.EAPType       | R/W | EAP type for the selected Wi-Fi profile                    | leap, eap-fast, peap-mschapv2, eap-tls, peap-tls   |
| InternetGatewayDevice.Laird.SavedProfileSettings.WEPType       | R/W | WEP type for the selected Wi-Fi profile                    | none, wep, wep-eap, psk, tkip, wpa2-psk, wpa2-aes, cckm-tkip, cckm-aes, wpa-psk-aes, wpa-aes |
| InternetGatewayDevice.Laird.SavedProfileSettings.Mode          | R/W | Selected Wi-Fi profile mode                                | BGN  |
| InternetGatewayDevice.Laird.SavedProfileSettings.Powersave     | R/W | Displays the enabled power save mode                       | off,max,fast   |
| InternetGatewayDevice.Laird.SavedProfileSettings.PSPDelay      | R/W | Selected Wi-Fi profile's power save delay                  | A value 10 - 500 in units of milliseconds.   |
| InternetGatewayDevice.Laird.SavedProfileSettings.Username      | R/W | Wi-Fi profile username used by some authentication methods | Username string  |
| InternetGatewayDevice.Laird.SavedProfileSettings.Password      | W   | Wi-Fi profile password used by some authentication methods | Password (write only) string   |

### 9.6.5.8 InternetGatewayDevice.ManagementServer

**Table 9: InternetGatewayDevice.ManagementServer**

| Parameter Name  | R/W | Description                                     | Input Data  |
|---|-----|---|---|
| <b>InternetGatewayDevice.ManagementServer</b>               | O   | Standard TR-069 Management Server node          |   |
| InternetGatewayDevice.ManagementServer.ConnectionRequestURL | R/W | URL for the ACS to use to initiate a connection | URL used by the ACS to initiate a connection with the gateway |
| InternetGatewayDevice.ManagementServer.ParameterKey         | R/W |   | String representing the parameter key (opt.)                  |
| InternetGatewayDevice.ManagementServer.PeriodicInformTime   | R/W | Time of the last inform message                 | String representing the time of the last inform message       |

| Parameter Name   | R/W | Description   | Input Data  |
|--|-----|---|---|
| InternetGatewayDevice.ManagementServer.PeriodicInformInterval    | R/W | Interval for the periodic inform message                            | Numeric value representing the periodic inform interval                   |
| InternetGatewayDevice.ManagementServer.PeriodicInformEnable      | R/W | Enables periodic inform   | true, false   |
| InternetGatewayDevice.ManagementServer.Password                  | W   | Password used to initiate a connection with the ACS                 | String representing the password for connections initiated by the gateway |
| InternetGatewayDevice.ManagementServer.ConnectionRequestUsername | R/W | Username used for the ACS to initiate a connection with the gateway | String representing the username for connections initiated by the ACS     |
| InternetGatewayDevice.ManagementServer.ConnectionRequestPassword | W   | Password used for the ACS to initiate a connection with the gateway | String representing the password for connections initiated by the ACS     |
| InternetGatewayDevice.ManagementServer.Username                  | R/W | Username for the gateway to initiate a connection with the ACS      | String representing the username for connections initiated by the gateway |
| InternetGatewayDevice.ManagementServer.URL                       | R/W | URL for the gateway to initiate a connection with the ACS           | URL used by the gateway to initiate a connection with the ACS             |

### 9.6.5.9 InternetGatewayDevice.WANDevice

Table 10: InternetGatewayDevice.WANDevice

| Parameter Name  | R/W | Description  | Input Data |
|---|-----|--|------------|
| InternetGatewayDevice.WANDevice   | O   | Standard node for Wi-Fi endpoint configuration. Only one Wi-Fi connection is allowed on this gateway | N/A        |
| InternetGatewayDevice.WANDevice.{x}   | O   | Sub-node for each Wi-Fi device. Only one Wi-Fi connection allowed on this gateway                    | N/A        |
| InternetGatewayDevice.WANDevice.{x}.WANConnectionDevice                     | O   | Sub-node for each Wi-Fi device. Only one Wi-Fi connection is allowed on this gateway                 | N/A        |
| InternetGatewayDevice.WANDevice.{x}.WANConnectionDevice.{y}                 | O   | Sub-node for each WiFi device. Only one Wi-Fi connection is allowed on this gateway                  | N/A        |
| InternetGatewayDevice.WANDevice.{x}.WANConnectionDevice.{y}.WANIPConnection | O   | Sub-node for each Wi-Fi device. Only one Wi-Fi connection is allowed on this gateway                 | N/A        |



| Parameter Name  | R/W | Description  | Input Data |
|---|-----|--|------------|
| <b>InternetGatewayDevice.WANDevice.{x}.WANConnectionDevice.{y}.WANIPConnection.{z}</b>            | O   | Sub-node for each Wi-Fi device. Only one Wi-Fi connection is allowed on this gateway | N/A        |
| InternetGatewayDevice.WANDevice.{x}.WANConnectionDevice.{y}.WANIPConnection.{z}.ConnectionStatus  | R   | Connection status  | N/A        |
| InternetGatewayDevice.WANDevice.{x}.WANConnectionDevice.{y}.WANIPConnection.{z}.ExternalIPAddress | R   | IP address (not necessarily external)  | N/A        |
| InternetGatewayDevice.WANDevice.{x}.WANConnectionDevice.{y}.WANIPConnection.{z}.MACAddress        | R   | MAC address  | N/A        |

### 9.6.5.10 InternetGatewayDevice.IPPingDiagnostics

**Table 11: InternetGatewayDevice.IPPingDiagnostics**

| Parameter Name  | R/W | Description                            | Input Data |
|---|-----|--|------------|
| <b>InternetGatewayDevice.IPPingDiagnostics</b>              | O   | Diagnostic data for the IP connections | N/A        |
| InternetGatewayDevice.IPPingDiagnostics.DiagnosticsState    | R   | Diagnostic data for the IP connections | N/A        |
| InternetGatewayDevice.IPPingDiagnostics.Host                | R   | Diagnostic data for the IP connections | N/A        |
| InternetGatewayDevice.IPPingDiagnostics.NumberOfRepetitions | R   | Diagnostic data for the IP connections | N/A        |
| InternetGatewayDevice.IPPingDiagnostics.Timeout             | R   | Diagnostic data for the IP connections | N/A        |
| InternetGatewayDevice.IPPingDiagnostics.DataBlockSize       | R   | Diagnostic data for the IP connections | N/A        |
| InternetGatewayDevice.IPPingDiagnostics.SuccessCount        | R   | Diagnostic data for the IP connections | N/A        |
| InternetGatewayDevice.IPPingDiagnostics.AverageResponseTime | R   | Diagnostic data for the IP connections | N/A        |
| InternetGatewayDevice.IPPingDiagnostics.MinimumResponseTime | R   | Diagnostic data for the IP connections | N/A        |
| InternetGatewayDevice.IPPingDiagnostics.MaximumResponseTime | R   | Diagnostic data for the IP connections | N/A        |
| InternetGatewayDevice.IPPingDiagnostics.FailureCount        | R   | Diagnostic data for the IP connections | N/A        |

### 9.6.5.11 InternetGatewayDevice.LANDevice

**Table 11: InternetGatewayDevice.LANDevice**

| Parameter Name  | R/W | Description                       | Input Data                                      |
|---|-----|-----------------------------------|---|
| <b>InternetGatewayDevice.LANDevice</b>                                | O   | Defines Wi-Fi settings            | N/A   |
| <b>InternetGatewayDevice.LANDevice.{x}</b>                            | O   | Defines Wi-Fi settings            | N/A   |
| <b>InternetGatewayDevice.LANDevice.{x}.WLANConfiguration</b>          | O   | Defines Wi-Fi settings            | N/A   |
| <b>InternetGatewayDevice.LANDevice.{x}.WLANConfiguration.{y}</b>      | O   | Defines Wi-Fi settings            | N/A   |
| InternetGatewayDevice.LANDevice.{x}.WLANConfiguration.{y}.Enable      | R/W | Enables the specific Wi-Fi device | true, false                                     |
| InternetGatewayDevice.LANDevice.{x}.WLANConfiguration.{y}.RadioEnable | R/W | Enables the specific Wi-Fi device | true, false                                     |
| InternetGatewayDevice.LANDevice.{x}.WLANConfiguration.{y}.SSID        | R/W | Enables the specific Wi-Fi device | Represents the SSID of the active Wi-Fi profile |

### 9.6.5.12 InternetGatewayDevice.Cellular

**Note:** Provisioning of these data fields is only supported with the RG191+LTE hardware for the US market only, see [Ordering Information](#) for product part numbers.

**Table 12: InternetGatewayDevice.Cellular**

| Parameter Name   | R/W | Description  | Input Data  |
|--|-----|--|---|
| <b>InternetGatewayDevice.Cellular</b>                                | O   | This is the TR-181 cellular node.  | N/A   |
| <b>InternetGatewayDevice.Cellular.AccessPoint.{x}</b>                | O   | This is the subnode for each access point supported. Currently only 1 is supported by this platform.                     | N/A   |
| InternetGatewayDevice.Cellular.AccessPoint.{x}.APN                   | R/W | The APN used to route data traffic from this cellular modem.   | A string representing the APN.                        |
| InternetGatewayDevice.Cellular.AccessPoint.{x}.UserName              | R/W | The username for the cellular account. This is optional. Not all network operators require a username and password.      | A string representing the username.                   |
| InternetGatewayDevice.Cellular.AccessPoint.{x}.Password              | W   | The password for the cellular account. This is optional. Not all network operators require a username and password.      | A string representing the password.                   |
| <b>InternetGatewayDevice.Cellular.Interface.{x}</b>                  | O   | This is the subnode for each interface (cellular modem) supported. Currently only 1 modem is supported by this platform. | N/A   |
| InternetGatewayDevice.Cellular.Interface.{x}.CurrentAccessTechnology | R   | The radio access technology currently in use. This platform only supports LTE.   | N/A   |
| InternetGatewayDevice.Cellular.Interface.{x}.DNS1                    | R/W | The first DNS server override.   | A string representing the IP address of a DNS server. |
| InternetGatewayDevice.Cellular.Interface.{x}.DNS2                    | R/W | The second DNS server override.  | A string representing the IP address of a DNS server. |
| InternetGatewayDevice.Cellular.Interface.{x}.Enable                  | R/W | Enable or disable the modem.   | true = enabled, false = disabled.                     |
| InternetGatewayDevice.Cellular.Interface.{x}.IMEI                    | R   | The IMEI of the modem.   | N/A   |
| InternetGatewayDevice.Cellular.Interface.{x}.IPv4                    | R   | The IPv4 address acquired from the network.  | N/A   |
| InternetGatewayDevice.Cellular.Interface.{x}.NetworkInUse            | R   | The name of the network operator and mcc and mnc of the network.   | N/A   |
| InternetGatewayDevice.Cellular.Interface.{x}.RSSI                    | R   | The RSSI in dBm.   | N/A   |
| InternetGatewayDevice.Cellular.Interface.{x}.Status                  | R   | The status of the connection. true = connected, false = not connected.   | N/A   |
| <b>InternetGatewayDevice.Cellular.Interface.{x}.Stats</b>            | O   | This is the subnode reporting the data usage statistics for the interface.   | N/A   |
| InternetGatewayDevice.Cellular.Interface.{x}.Stats.BytesReceived     | R   | The number of bytes (RX).  | N/A   |
| InternetGatewayDevice.Cellular.Interface.{x}.Stats.BytesSent         | R   | The number of bytes (TX).  | N/A   |
| InternetGatewayDevice.Cellular.Interface.{x}.Stats.ErrorsReceived    | R   | The number of RX errors.   | N/A   |
| InternetGatewayDevice.Cellular.Interface.{x}.Stats.ErrorsSent        | R   | The number of TX errors.   | N/A   |
| InternetGatewayDevice.Cellular.Interface.{x}.Stats.PacketsReceived   | R   | The number of Packets (RX)   | N/A   |
| InternetGatewayDevice.Cellular.Interface.{x}.Stats.PacketsSent       | R   | The number of Packets (TX)   | N/A   |
| <b>InternetGatewayDevice.Cellular.Interface.{x}.USIM</b>             | O   | This is the subnode reporting USIM data for this interface.  | N/A   |
| InternetGatewayDevice.Cellular.Interface.{x}.USIM.ICCID              | R   | This is the ICCID of the SIM card that is inserted.  | N/A   |
| InternetGatewayDevice.Cellular.Interface.{x}.USIM.IMSI               | R   | This is the IMSI stored on the SIM card that is inserted.  | N/A   |

### 9.6.5.13 InternetGatewayDevice.WiFi

**Table 12: InternetGatewayDevice.WiFi**

| Parameter Name  | R/W | Description  | Input Data   |
|---|-----|--|--|
| <b>InternetGatewayDevice.WiFi</b>   | O   | The TR-181 Wi-Fi node.   | N/A  |
| <b>InternetGatewayDevice.WiFi.Radio</b>                                     | O   | Sub-node for each Wi-Fi radio (only one on the gateway)  | N/A  |
| <b>InternetGatewayDevice.WiFi.Radio.{x}</b>                                 | O   | Sub-node for the Wi-Fi radio settings for each Wi-Fi radio (only one on the gateway)               | N/A  |
| InternetGatewayDevice.WiFi.Radio.{x}.AutoChannelEnable                      | R   | Whether/not auto channel is enabled  | N/A  |
| InternetGatewayDevice.WiFi.Radio.{x}.Enable                                 | R   | Whether/not the interface is enabled   | N/A  |
| InternetGatewayDevice.WiFi.Radio.{x}.Status                                 | R   | Interface status   | N/A  |
| InternetGatewayDevice.WiFi.Radio.{x}.Name                                   | R   | Interface name   | N/A  |
| InternetGatewayDevice.WiFi.Radio.{x}.SupportedFrequencyBands                | R   | Supported Wi-Fi frequencies  | N/A  |
| InternetGatewayDevice.WiFi.Radio.{x}.OperatingFrequencyBand                 | R   | Currently used Wi-Fi frequencies   | N/A  |
| InternetGatewayDevice.WiFi.Radio.{x}.ChannelsInUse                          | R   | Whether/not the channel is in use  | N/A  |
| InternetGatewayDevice.WiFi.Radio.{x}.Channel                                | R   | Indicates the applicable channel   | N/A  |
| InternetGatewayDevice.WiFi.Radio.{x}.AutoChannelSupported                   | R   | Whether/not auto channel is supported  | N/A  |
| InternetGatewayDevice.WiFi.Radio.{x}.OperatingStandards                     | R   | Supported Wi-Fi modes  | N/A  |
| <b>InternetGatewayDevice.WiFi.SSID</b>                                      | O   | SSID node  | N/A  |
| <b>InternetGatewayDevice.WiFi.SSID.{x}</b>                                  | O   |  | N/A  |
| InternetGatewayDevice.WiFi.SSID.{x}.Enable                                  | R/W | Whether/not SSID is enabled  | true, false  |
| InternetGatewayDevice.WiFi.SSID.{x}.Status                                  | R   | SSID status  | N/A  |
| InternetGatewayDevice.WiFi.SSID.{x}.Name                                    | R/W | SSID profile name  | The profile name string                                    |
| InternetGatewayDevice.WiFi.SSID.{x}.LowerLayers                             | R/W | Reference to the radio in the data model   | Reference in the data model to the active radio string     |
| InternetGatewayDevice.WiFi.SSID.{x}.SSID                                    | R/W | SSID   | SSID for your Wi-Fi network string                         |
| InternetGatewayDevice.WiFi.SSID.{x}.X_IPInterface                           | R/W | Reference to the IP interface in the data model  | The reference to the IP interface in the data model string |
| <b>InternetGatewayDevice.WiFi.EndPoint</b>                                  | O   | Defines each endpoint (Wi-Fi profile)  | N/A  |
| <b>InternetGatewayDevice.WiFi.EndPoint.{x}</b>                              | O   |  | N/A  |
| <b>InternetGatewayDevice.WiFi.EndPoint.{x}.Profiles</b>                     | O   |  | N/A  |
| <b>InternetGatewayDevice.WiFi.EndPoint.{x}.Profiles.{y}</b>                 | O   |  | N/A  |
| <b>InternetGatewayDevice.WiFi.EndPoint.{x}.Profiles.{y}.Security</b>        | O   | Sub-node that defines the security settings used in the Wi-Fi profile.                             | N/A  |
| InternetGatewayDevice.WiFi.EndPoint.{x}.Profiles.{y}.Security.WEPKey        | R/W | WEP key when WEP mode is enabled   | A string representing the WEP key.                         |
| InternetGatewayDevice.WiFi.EndPoint.{x}.Profiles.{y}.Security.PreSharedKey  | W   | PSK used for various security modes. Either the passphrase or pre-shared key can be entered here.  | A string representing the PSK.                             |
| InternetGatewayDevice.WiFi.EndPoint.{x}.Profiles.{y}.Security.KeyPassphrase | W   | Passphrase for the WPA/WPA2 security. Either the passphrase or pre-shared key can be entered here. | A string representing the PSK.                             |
| InternetGatewayDevice.WiFi.EndPoint.{x}.Profiles.{y}.Security.ModeEnabled   | R/W | Displays the enabled security mode. These are the standard TR-181 security type strings            | A string selected from InternetGateway                     |

| Parameter Name   | R/W | Description   | Input Data  |
|--|-----|---|---|
|  |     |   | yDevice.WiFi.EndPoint.{x}.Security.ModesSupported.    |
| InternetGatewayDevice.WiFi.EndPoint.{x}.Profiles.{y}.Security.AuthType         | R/W | Indicates which authentication mode is enabled                    | open, shared, or eap                                  |
| InternetGatewayDevice.WiFi.EndPoint.{x}.Profiles.{y}.Security.EAPType          | R/W | Indicates which EAP mode is enabled                               | leap, eap-fast, peap-mschapv2, eap-tls, peap-tls      |
| InternetGatewayDevice.WiFi.EndPoint.{x}.Profiles.{y}.Security.Username         | R/W | Username used for authentication                                  | A string representing the username.                   |
| InternetGatewayDevice.WiFi.EndPoint.{x}.Profiles.{y}.Security.Password         | W   | Password used for authentication                                  | A string representing the password.                   |
| InternetGatewayDevice.WiFi.EndPoint.{x}.Profiles.{y}.Security.CACertificate    | R/W | Certificate file path   | A string representing the path to the CA certificate. |
| InternetGatewayDevice.WiFi.EndPoint.{x}.Profiles.{y}.Security.UserCertName     | R/W | Certificate name  | A string representing the certificate name.           |
| InternetGatewayDevice.WiFi.EndPoint.{x}.Profiles.{y}.Security.UserCertPassword | W   | Certificate password  | A string representing the certificate path.           |
| InternetGatewayDevice.WiFi.EndPoint.{x}.Profiles.{y}.Security.PACName          | R/W | PAC file name   | A string representing the PAC name.                   |
| InternetGatewayDevice.WiFi.EndPoint.{x}.Profiles.{y}.Security.PACPassword      | W   | The PAC file password   | A string representing the PAC password.               |
| InternetGatewayDevice.WiFi.EndPoint.{x}.Profiles.{y}.Enable                    | R/W | Whether/not the profile is enabled                                | true, false   |
| InternetGatewayDevice.WiFi.EndPoint.{x}.Profiles.{y}.Alias                     | R/W | Profile name  | A string representing the Wi-Fi profile name.         |
| InternetGatewayDevice.WiFi.EndPoint.{x}.Profiles.{y}.SSID                      | R/W | Profile SSID  | A string representing the Wi-Fi network SSID.         |
| InternetGatewayDevice.WiFi.EndPoint.{x}.Profiles.{y}.Status                    | R   | Connection status   | N/A   |
| <b>InternetGatewayDevice.WiFi.EndPoint.{x}.Security</b>                        | O   | Defines security supported by the gateway                         | N/A   |
| InternetGatewayDevice.WiFi.EndPoint.{x}.Security.ModesSupported                | R   | Comma-separated list of supported security modes                  | N/A   |
| InternetGatewayDevice.WiFi.EndPoint.{x}.ProfileNumberOfEntries                 | R   | Number of profiles  | N/A   |
| InternetGatewayDevice.WiFi.EndPoint.{x}.SSIDReference                          | R   | Data model reference to the SSID for the currently active profile | N/A   |
| InternetGatewayDevice.WiFi.EndPoint.{x}.ProfileReference                       | R   | Profile reference for the currently active profile                | N/A   |
| InternetGatewayDevice.WiFi.EndPoint.{x}.Status                                 | R   | Profile status  | N/A   |
| InternetGatewayDevice.WiFi.EndPoint.{x}.Enable                                 | R/W |   | true, false   |

### 9.6.5.14 InternetGatewayDevice.IP

Table 13: InternetGatewayDevice.IP

| Parameter Name  | R/W | Description   | Input Data |
|---|-----|---|------------|
| InternetGatewayDevice.IP  | O   | This node provides stats for all the IP interfaces. There are 2 on the gateway, eth0 and wlan0. | N/A        |
| InternetGatewayDevice.IP.Interface                                    | O   |   | N/A        |
| InternetGatewayDevice.IP.Interface.{x}                                | O   |   | N/A        |
| InternetGatewayDevice.IP.Interface.{x}.Stats                          | O   |   | N/A        |
| InternetGatewayDevice.IP.Interface.{x}.Stats.DiscardPacketsReceived   | R   | The number of discarded packets (RX).   | N/A        |
| InternetGatewayDevice.IP.Interface.{x}.Stats.DiscardPacketsSent       | R   | The number of discarded packets (TX).   | N/A        |
| InternetGatewayDevice.IP.Interface.{x}.Stats.ErrorsReceived           | R   | The number of RX errors.  | N/A        |
| InternetGatewayDevice.IP.Interface.{x}.Stats.PacketsReceived          | R   | The number of packets (RX).   | N/A        |
| InternetGatewayDevice.IP.Interface.{x}.Stats.PacketsSent              | R   | The number of packets (TX).   | N/A        |
| InternetGatewayDevice.IP.Interface.{x}.Stats.BytesReceived            | R   | The number of bytes (RX).   | N/A        |
| InternetGatewayDevice.IP.Interface.{x}.Stats.BytesSent                | R   | The number of bytes (TX).   | N/A        |
| InternetGatewayDevice.IP.Interface.{x}.Stats.ErrorsSent               | R   | The number of TX errors.  | N/A        |
| InternetGatewayDevice.IP.Interface.{x}.IPv4Address                    | O   | IPv4 Settings for the particular IP interface.  | N/A        |
| InternetGatewayDevice.IP.Interface.{x}.IPv4Address.{y}                | O   |   | N/A        |
| InternetGatewayDevice.IP.Interface.{x}.IPv4Address.{y}.SubnetMask     | R   | The subnet mask.  | N/A        |
| InternetGatewayDevice.IP.Interface.{x}.IPv4Address.{y}.Enable         | R   | Is this interface enabled.  | N/A        |
| InternetGatewayDevice.IP.Interface.{x}.IPv4Address.{y}.AddressingType | R   | The addressing type.  | N/A        |
| InternetGatewayDevice.IP.Interface.{x}.IPv4Address.{y}.IPAddress      | R   | The current IP address.   | N/A        |
| InternetGatewayDevice.IP.Interface.{x}.IPv4AddressNumberOfEntries     | R   | The number of IPv4 entries in this node (only 1 for the gateway)                                | N/A        |
| InternetGatewayDevice.IP.Interface.{x}.Type                           | R   | The type of IP interface.   | N/A        |
| InternetGatewayDevice.IP.Interface.{x}.Name                           | R   | The name of the interface.  | N/A        |
| InternetGatewayDevice.IP.Interface.{x}.Enable                         | R   | Is the interface enabled.   | N/A        |

## 9.7 Debug

At the bottom of the web UI is a debug pane that can be used to view system logs on the gateway. Click the arrow buttons to expand or collapse the debug pane. To start or stop debug log polling, click **Auto Update Logs**.

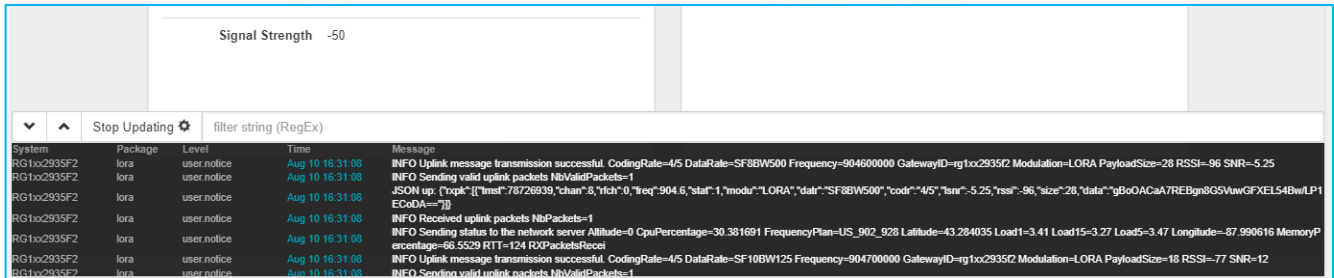

Figure 56: Debug info

## 9.8 Factory Reset

To factory reset the gateway back to default settings, complete the following steps:

1. Hold the user button while power is applied *OR* hold the user button while you press the reset button (Figure 57).



*Figure 57: Performing a factory reset*

2. Continue to hold the user button until all the LEDs on the top begin to flash.
3. Once the LEDs start flashing, release the user button.
4. The factory defaults are applied, the gateway reboots, and it is ready to use.

## 9.9 Bluetooth

At this time the Bluetooth and Bluetooth Low Energy functionality onboard the RG1xx Gateway is not enabled. Please visit the RG1xx page on Lairdconnect.com for more information: <https://www.lairdconnect.com/wireless-modules/lorawan-solutions/sentrius-rg1xx-lora-enabled-gateway-wi-fi-bluetooth-ethernet>

## 10 IP67 RATED ENCLOSURE

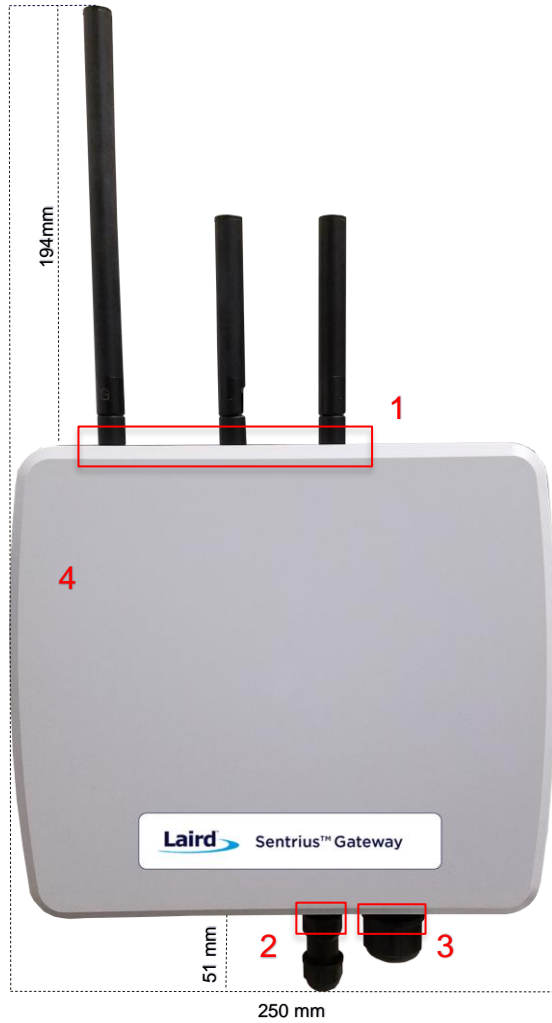

| Reference | Description             |
|-----------|-------------------------|
| 1         | LoRa and Wi-Fi antennas |
| 2         | Power supply module     |
| 3         | CAT6 Ethernet module    |
| 4         | Moulded plastic cover   |

Figure 58: Top of the IP67 Rated Sentrius™ RG1xx Gateway

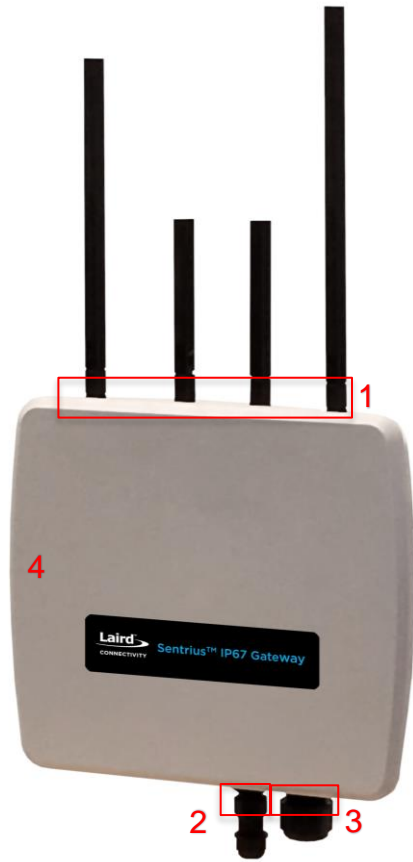

| Reference | Description  |
|-----------|--|
| 1         | LoRa, Wi-Fi and LTE antenna<br>(LTE on RG191+LTE model only) |
| 2         | Power supply module  |
| 3         | CAT6 Ethernet module   |
| 4         | Moulded plastic cover  |

Figure 59: Top of the IP67 Rated Sentrius™ RG191+LTE Gateway

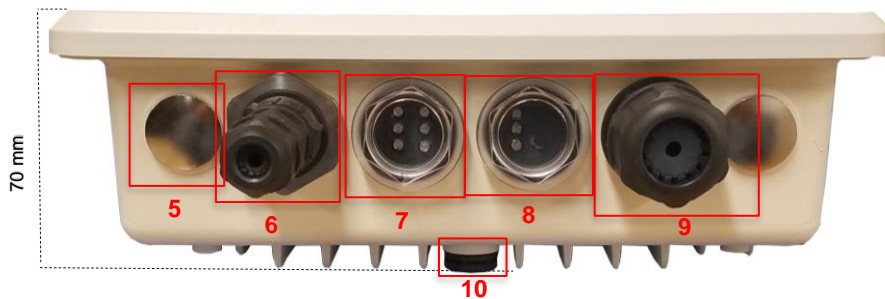

| Ref. | Description   |
|------|---|
| 5    | Metal cover plug (2) –<br>Available data/power ports<br>for expansion |
| 6    | Power supply module   |
| 7    | Six LED displays with<br>transparent dust cover                       |
| 8    | Three LED display and<br>User button with<br>transparent dust cover   |
| 9    | CAT6 Ethernet module  |
| 10   | Plastic gore ventilation plug   |

Figure 60: Side panel of the IP67 Rated Sentrius™ RG1xx Gateway (Current Generation)



## 10.1 Specification

| Category                     | Feature                               | Specification   |
|------------------------------|---------------------------------------|---|
| Interfaces                   | Wired                                 | CAT6 Ethernet - RJ45 Connector<br>LED Data Communication Ports (2)<br>Optional Data Communication/Power Ports Available for Expansion (2)   |
|                              | Wireless                              | LoRa, 802.11a/b/g/n, Cellular LTE (Only RG191+LTE model)  |
| Power                        | Supply Voltage                        | 12V/1A  |
|                              | Power Adapter/Cable                   | External DC Power Supply (12V/2A rating) with regional plug adapter – Industrial Temperature Rated (supplied by end-user)   |
|                              | Configuration                         | Web-based interface via Ethernet/Wi-Fi  |
| Physical                     | Dimensions                            | 220 x 250 x 70 mm (enclosure only)  |
| Environmental                | Operating Temp.                       | -40° to +85°C   |
| Wi-Fi Antenna                | Model                                 | Laird 001-0012 IP67-rated   |
|                              | Type                                  | Dipole  |
|                              | Connector                             | RP-SMA  |
|                              | Antenna Gain                          | 2.0 dBi (2.4–2.5 GHz), 2.0 dBi (4.9–5.875 GHz)  |
| LoRa Antenna                 | Model                                 | Laird 001-0029 IP67-rated (863–870 MHz) used with RG186   |
|                              |                                       | Laird 001-0011 IP67-rated (902–928 MHz) used with RG191   |
|                              | Type                                  | Dipole  |
|                              | Connector                             | RP-SMA  |
| Antenna Gain                 | 2.0 dBi (863–870 MHz) used with RG186 |   |
|                              | 2.0 dBi (902–928 MHz) used with RG191 |   |
| LTE Antenna (RG191+LTE Only) | Model                                 | ▪ Laird 001-00004 IP67 LTE antenna  |
|                              | Type                                  | ▪ Dipole  |
|                              | Connector                             | ▪ SMA-Male  |
|                              | Antenna Gain                          | ▪ Up to 2.2dBi  |
| Accessories                  | Included                              | <ul style="list-style-type: none"> <li>▪ 1 x 863-870 MHz antenna (with RG186) or 1 x 902-928 MHz antenna (with RG191)</li> <li>▪ 1 x 698-960/1710-2700 MHz LTE antenna (with RG191+LTE)</li> <li>▪ 2 x 2.4/5 GHz Wi-Fi antennas</li> </ul> <p><b>Note: Mounting hardware (wall mount or pole mount available) – sold separately</b></p> |
| Enclosure                    | IP67 Rated                            | <ul style="list-style-type: none"> <li>▪ External enclosure housing for Main Gateway PCB</li> <li>▪ Molded plastic cover</li> <li>▪ Anti-corrosive</li> <li>▪ Die Cast Alloy Frame (Al-Si-Mg)</li> </ul>  |
| Warranty                     |                                       | One-year warranty   |

## 10.2 LED Display Reference

### 10.2.1 Three LED Display with User Button

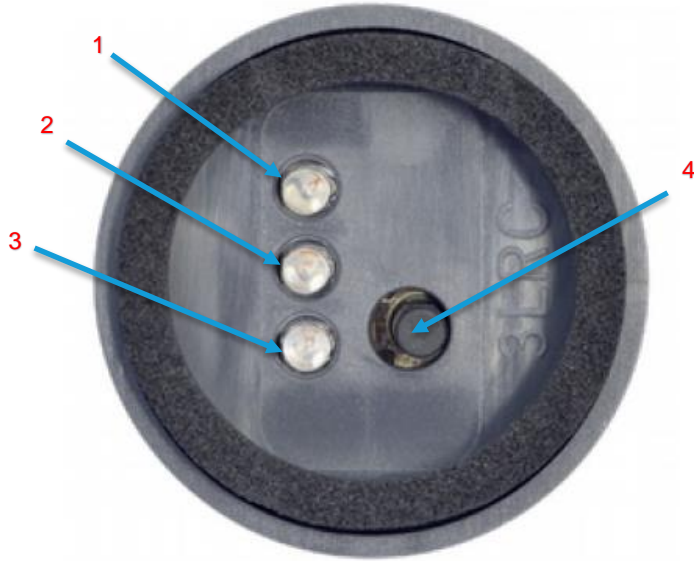

| Reference | Description   |
|-----------|---------------|
| 1         | Power (green) |
| 2         | LoRa (green)  |
| 3         | BLE (green)   |
| 4         | User Button   |

Figure 61: LED displays with User button (#6 from Figure 60)

### 10.2.2 Six LED Display

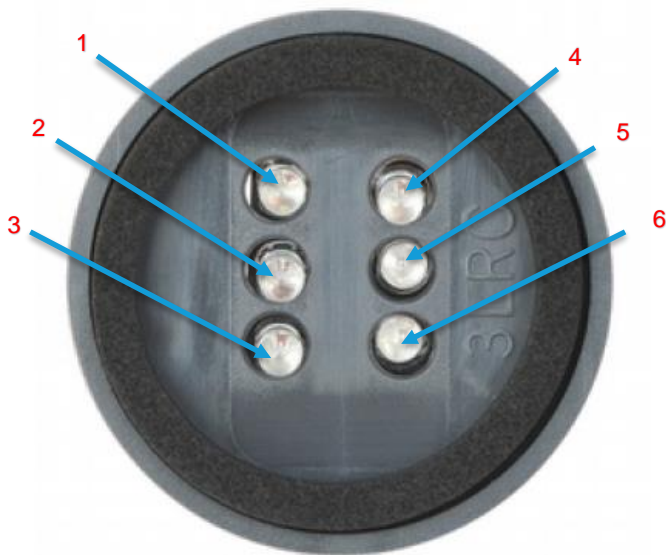

| Reference | Description |
|-----------|-------------|
| 1         | Power       |
| 2         | Ethernet    |
| 3         | Wi-Fi       |
| 4         | N/A         |
| 5         | User        |
| 6         | LTE         |

**Note:** All LEDs are green.

Figure 62: Six LED display (#7 from Figure 60)

## 10.3 Previous Generation Connector Adapter Layout

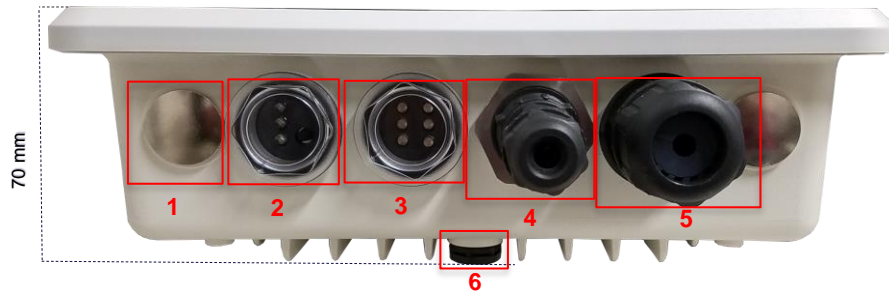

Figure 63: Side panel of the IP67 Rated Sentrius™ RG1xx Gateway (Revision 1 & 2)

| Ref. | Description   |
|------|---|
| 1    | Metal cover plug (2) – Available data/power ports for expansion |
| 2    | Three LED display and User button with transparent dust cover   |
| 3    | Six LED displays with transparent dust cover                    |
| 4    | Power supply module   |
| 5    | CAT6 Ethernet module  |
| 6    | Plastic gore ventilation plug                                   |

## 10.4 Cable Assemblies

### 10.4.1 Power Supply and Ethernet Module

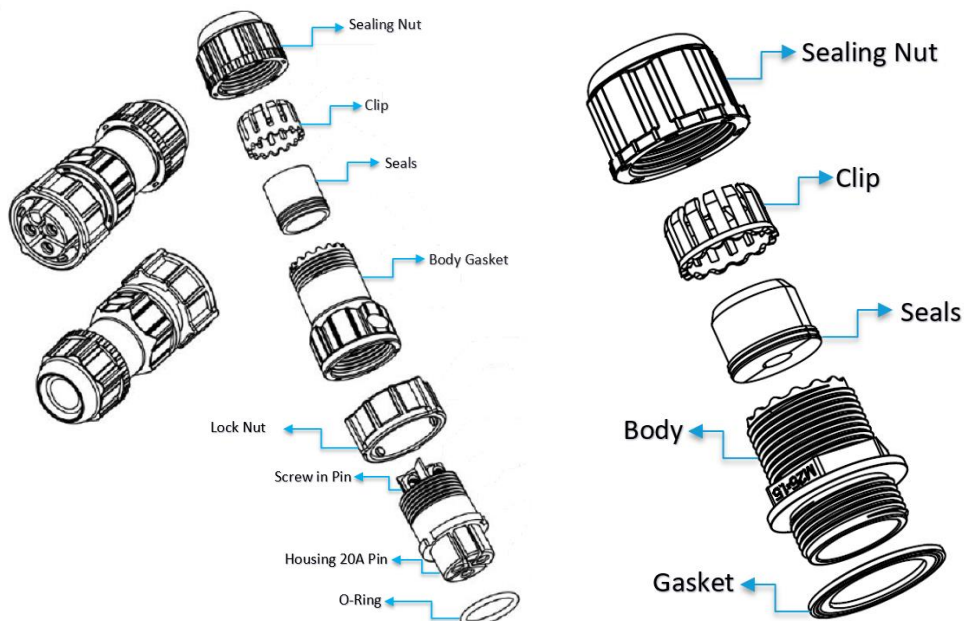

Figure 64: Power cable (left) and Ethernet (right) assembly components

## 10.4.2 Assembly Steps

The steps explained below cover the power cable assembly process in detail. The ethernet cable assembly is very similar, however less complex, to work with. In general, place the Ethernet cord through each component and mount to the enclosure. Tighten the Sealing Nut with a **Torque Force of 8 ~ 10 kgf.cm**. The rest of the guide covers the power cord assembly.

**Note:** To ensure the IP67 rating, the Ethernet cable diameter must be in the range of 4.5 mm – 6.5 mm. If the cable is too small, there is a potential risk of environment factors potentially damaging the internal hardware.

To assemble the power cable, follow these steps:

1. Insert the power cord through each component – sealing nut (i), clip (ii), sealing (iii), sealing body (iv), gasket (v), and lock nut (vi) (Figure 65).

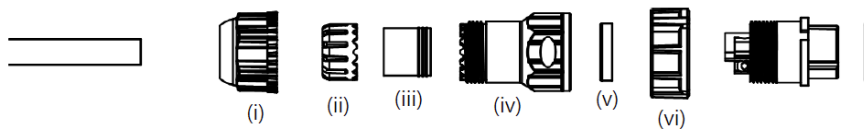

Figure 65: Insert power cable

**Note:** To ensure the IP67 rating, the **cable diameter must be in the range of 5.5 mm – 8.0 mm**. If the cable is too small, there is a potential risk of environment factors potentially damaging the internal hardware.

2. Use a 1.5 mm screwdriver, preferably an allen wrench, to fix the core wire(s) into the screw fixing point (Figure 66).

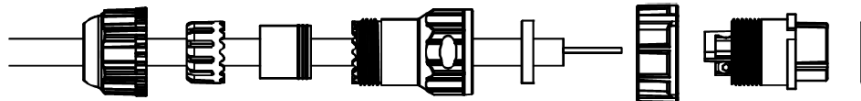

Figure 66: Core wire fixed into the screw fixing point

**Note:** The cable core wires for the power cable assembly need to be in the range of 14 AWG to 18 AWG to fit properly in the screw points. We recommend that you strip and tin the ends of the core cable wires to make the install easier when inserting the wire into the screw points. Range of length tinning wire: 5 mm– 6 mm.

Pin 2 should be negative (black wire) and Pin 1 should be positive (red wire). It is recommended to install an Earth Ground Wire. There are positions available on the enclosure for this (Figure 72).



3. Fit the gasket (v), sealing (iii), and clip (ii) onto the sealing body (iv) (Figure 67).
4. Fit the lock (vi) and o-ring (ix) onto the housing (vii) (Figure 67).

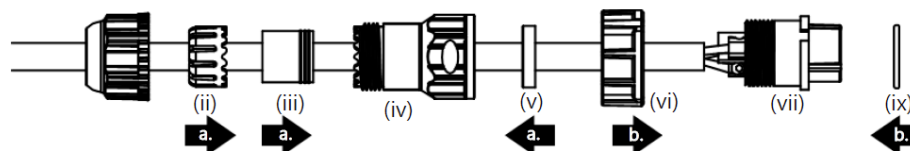

Figure 67: Steps 3 and 4

- Screw the sealing nut (i) and the assembled housing (x) onto the assembled sealing body (xi) with a torque force of 8–10 kgf-cm (Figure 68).

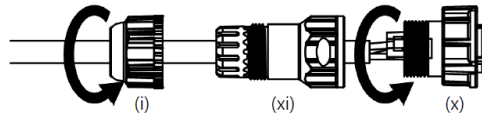

Figure 68: Step 5

The assembly is now complete (Figure 69).

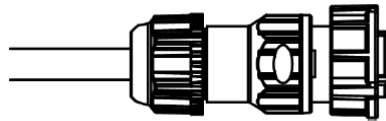

Figure 69: Completed assembly



- Mount the completed cables into the keyed power module slot and the Ethernet module slot #8 and #9 from Figure 60.

## 10.5 Mounting Hardware

### 10.5.1 Wall Mount



Figure 70: Wall Mount

#### Included Mounting Hardware

M6x0.8x10.0 mm, stainless steel screws with washers – 4

5/16 x 11 self-tapping screws, L=25.00 mm – 4

3/4" wall anchors – 4

4" hose clamps – 2

M5x1.0x10.0 mm, stainless steel screws with washers (optional) – 4

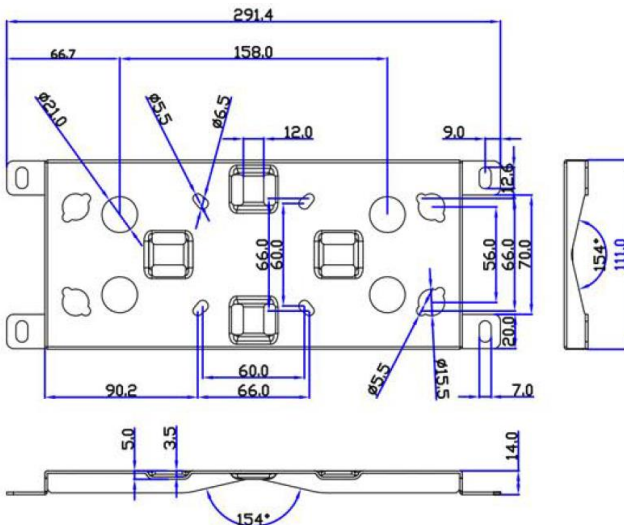

Figure 71: Wall mount dimensions

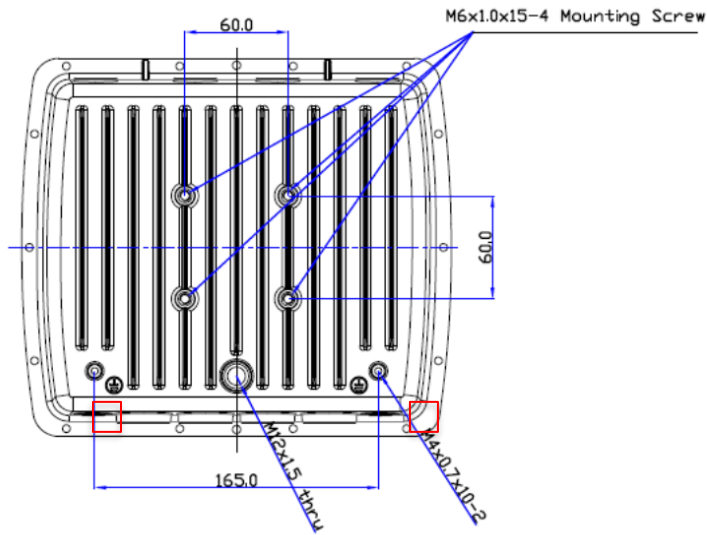

Figure 72: Enclosure placement dimensions (mm)

## 10.5.2 Pole Mount



Figure 73: Pole mount (pole diameter range ~34 mm – 90 mm)

### Included Mounting Hardware

M6x0.8x10.0 mm, stainless steel screws with washers – 4

5/16 x 11 Self-tapping screws, L=25.00 mm – 4

3/4" wall anchors – 4

M8x1.25x80.0 mm stainless steel screws with washers – 2

M8x1.25x90.0 mm Stainless Steel Screws with washers and nut – 1

M5x1.0mm Stainless Steel Screws, L = 10.0 mm with washers (optional) – 4

### 10.5.2.1 Dimensions

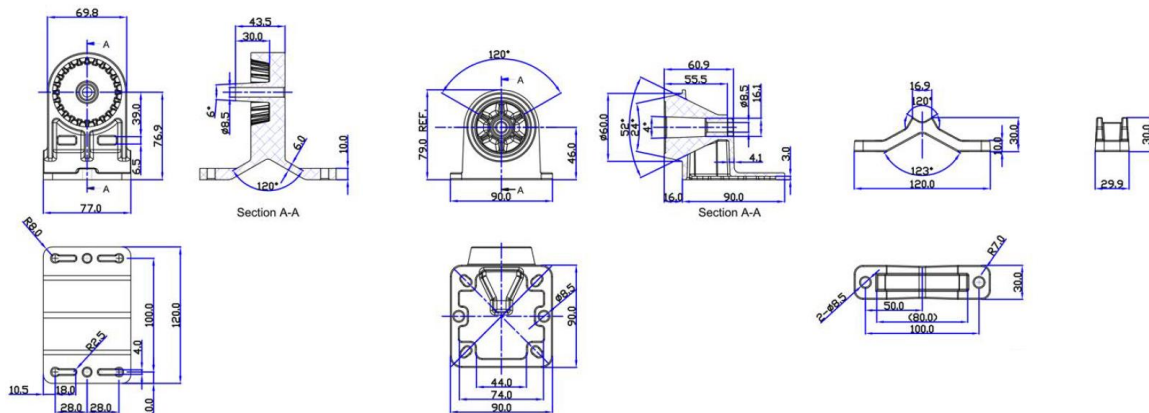

Figure 74: Pole mount dimensions

## 11 REGULATORY

### 11.1 Current Regulatory Certifications

The RG1xx holds current certifications in the following countries:

| Country/Region   | Regulatory ID   |
|------------------|---|
| USA (FCC)        | Contains the following:<br>RG191-M2 – SQG-1001<br>WB50NBT – SQG-WB50NBT     |
| EU (CE)          | Contains the following:<br>RG186-M2 – SQG-1002<br>WB50NBT – 3147A-WB50NBT   |
| UK               | UKCA  |
| UAB (TRA)        | TRA Registered No: ER61585/18 Dealer No: DA72940/18                         |
| Canada (ISED)    | Contains the following:<br>RG191-M2 – 3147A-1001<br>WB50NBT – 3147A-WB50NBT |
| Taiwan (NCC)     | CCAF19LP1820T2  |
| Australia        | C-Tick  |
| New Zealand      | C-Tick (R-NZ)   |
| Singapore (IMDA) | DA107248  |

### 11.2 Documentation Requirements

To ensure regulatory compliance, when integrating the RG1xx into a host device, it is necessary to meet the documentation requirements set forth by the applicable regulatory agencies. The following sections (FCC, ISED Canada, European Union, and others) outline the information that may be included in the user's guide and external labels.

### 11.3 FCC Regulatory

#### 11.3.1 RG191

The RG191 contains the RG191-M2 and the WB50NBT from Laird Connectivity

| Model    | US/FCC      |
|----------|-------------|
| RG191-M2 | SQG-1001    |
| WB50NBT  | SQG-WB50NBT |

### 11.3.2 RG191+LTE

**Note:** For complete regulatory information, refer to the [RG191+LTE Regulatory Information](#) document which is also available from the [RG191+LTE product page](#).

The RG191+LTE contains the RG191-M2, the WB50NBT from Laird, and the Quectel Wireless Solutions EG91-NA. It holds current certifications in the following countries:

| Model       | US/FCC          | CANADA/IC         |
|-------------|-----------------|-------------------|
| RG191+LTE   | SQG-RG191NALTE  | 3147A-RG191NALTE  |
| contains... |                 |                   |
| RG191-M2    | SQG-1001        | 3147A-1001        |
| WB50NBT     | SQG-WB50NBT     | 3147A-WB50NBT     |
| EG91-NA     | XMR201807EG91NA | 10224A-2018EG91NA |

### 11.3.3 LTE Network Certification

The RG191+LTE gateway operates on LTE networks based on PTCRB certification.

#### 11.3.3.1 PTCRB Certification

| Manufacturer       | Model            | Supported Technologies and Frequencies  | Hardware Version | Software Version | Web Link             |
|--------------------|------------------|---|------------------|------------------|----------------------|
| Laird Connectivity | RG191+LTE Series | <b>E-UTRA FDD:</b> <ul style="list-style-type: none"> <li>▪ Band 2</li> <li>▪ Band 4</li> <li>▪ Band 5</li> <li>▪ Band 12</li> <li>▪ Band 13</li> </ul> | v750.03.224      | v93.9.5.1        | <a href="#">Link</a> |

### 11.3.4 Power Exposure Information

To comply with FCC RF exposure limits for general population/uncontrolled exposure, the antenna(s) used for this transmitter must be installed to provide a separation distance of at least 20 cm from all persons and operating in conjunction with any other antenna or transmitter.

**IMPORTANT NOTE:** If these conditions cannot be met (for certain configurations or co-location with another transmitter), then the FCC and Industry Canada authorizations are no longer considered valid, and the FCC ID and IC Certification Number cannot be used on the final product. In these circumstances, the OEM integrator is responsible for re-evaluating the end product (including the transmitter) and obtaining a separate FCC and Industry Canada authorization.

### 11.3.5 OEM Responsibilities

To comply with FCC and Industry Canada RF exposure limits for general population/uncontrolled exposure, the antenna(s) used for this transmitter must be installed to provide a separation distance of at least 20 cm from all persons and operating in conjunction with any other antenna or transmitter, except in accordance with FCC multi-transmitter product procedures.

**WARNING:** Changes or modifications not expressly approved by Laird could void the user's authority to operate the equipment.



### 11.3.6 FCC Interference Statement

This equipment has been tested and found to comply with the limits for a Class B digital device, pursuant to Part 15 of the FCC Rules. These limits are designed to provide reasonable protection against harmful interference in a residential installation. This equipment generates, uses, and can radiate radio frequency energy and, if not installed and used in accordance with the instructions, may cause harmful interference to radio communications. However, there is no guarantee that interference will not occur in an installation. If this equipment does cause harmful interference to radio or television reception, which can be determined by turning the equipment off and on, the user is encouraged to correct the interference by one or more of the following measures:

- Re-orient or relocate the receiving antenna
- Increase the separation between the equipment and the receiver
- Connect the equipment to an outlet on a circuit different from that to which the receiver is connected.
- Consult the dealer or an experienced radio/TV technician for help.

### 11.3.7 FCC Warning

This device complies with part 15 of the FCC rules operation is subject to the following two conditions: (1) this device may not cause harmful interference, and (2) this device must accept any interference received, including interference that may cause undesired operation.

## 11.4 ISED (Canada) Regulatory

The RG191 contains the RG191-M2 and the WB50NBT from Laird.

| Model    | CANADA/ISED   |
|----------|---------------|
| RG191-M2 | 3147A-1001    |
| WB50NBT  | 3147A-WB50NBT |

### 11.4.1 ISED Warning

This device complies with Industry Canada license-exempt RSS standard(s). Operation is subject to the following two conditions: (1) this device may not cause interference, and (2) this device must accept any interference, including interference that may cause undesired operation of the device.

French equivalent is:

Le présent appareil est conforme aux CNR d'Industrie Canada applicable aux appareils radio exempts de licence. L'exploitation est autorisée aux deux conditions suivantes : (1) l'appareil ne doit pas produire de brouillage, et (2) l'utilisateur de l'appareil doit accepter tout brouillage radioélectrique subi, même si le brouillage est susceptible d'en compromettre le fonctionnement.

### 11.4.2 ISED Radiation Exposure Statement

To comply with ISED Canada RF exposure limits for general population / uncontrolled exposure, the antenna(s) used for this transmitter must be installed to provide a separation distance of at least 20 cm from all persons and must not be operating in conjunction with any other antenna or transmitter.

French equivalent is:

Déclaration IC d'exposition aux radiations

Pour se conformer à Industrie Canada RF limites d'exposition pour la population générale / exposition non contrôlée, l'antenne utilisée pour ce transmetteur doit être installée pour fournir une distance d'au moins 20 cm de toutes les personnes et ne doit pas fonctionner en conjonction avec toute autre antenne ou transmetteur.

## 11.5 Australia and New Zealand Regulatory

RCM: Pending Compliant to standards EN 300 328 V1.9.1, AS/NZS 4268: 2012-A1:2013, and EN 55022:2010/AC:2011  
If this device is used in a product, the OEM has responsibility to verify compliance of the final end product to the Australia/New Zealand (RCM) Standards. All end-products require their own certification (SDoc). You will not be able to leverage the module certification and ship product into the country.

## 11.6 Taiwan (NCC) Regulatory

The RG191 is approved for use in the Taiwan market.

| Model | Certificate Number |
|-------|--------------------|
| RG191 | CCAF19LP1820T2     |

第十二條→經型式認證合格之低功率射頻電機，非經許可，公司，商號或使用者均不得擅自變更頻率、加大功率或變更原設計之特性及功能。

第十四條→低功率射頻電機之使用不得影響飛航安全及干擾合法通信；經發現有干擾現象時，應立即停用，並改善至無干擾時方得繼續使用。

前項合法通信，指依電信法規定作業之無線電通信。低功率射頻電機須忍受合法通信或工業、科學及醫療用電波輻射性電機設備之干擾。

**Note:** You must place “本產品內含射頻模組： CCAF19LP1820T2” on the host product in such a location that it can be seen by an operator at the time of purchase.

## 11.7 EU Regulatory

The RG186 has been tested for compliance with relevant standards for the EU market. The RG186 module was tested with a 2 dBi antenna. The OEM can operate the RG186 module with any other type of antenna but must ensure that the gain does not exceed 2 dBi to maintain the Laird approval.

The OEM should consult with a qualified test house before entering their device into an EU member country to make sure all regulatory requirements have been met for their complete device.

### 11.7.1 User's Guide Requirements

The integrator must include specific information in the user's guide for the device into which the BT85x is integrated. In addition to the required FCC and IC statements outlined above, the following Radio Equipment Directive (RED) statements must be added in their entirety and without modification into a prominent place in the user's guide for the device into which the RG186 is integrated:

This device complies with the essential requirements of the 2014/53/EU – Radio Equipment Directive (RED). The following test methods have been applied in order to prove presumption of conformity with the essential requirements of the 2014/53/EU – Radio Equipment Directive (RED):

- **EN 62368-1:2014/A11:2017**  
Safety requirements for audio/video, information, and technology equipment
- **EN 300 328 v2.2.2 (2019-07)**  
Electromagnetic compatibility and Radio Spectrum Matters (ERM); Wideband Transmission systems; Data transmission equipment operating in the 2,4 GHz ISM band and using spread spectrum modulation techniques; Harmonized EN covering essential requirements under article 3.2 of the R&TTE Directive
- **EN 62311:2008 | EN 50665:2017 | EN 50385:2017**  
RF exposure

- **EN 301 489-1 v2.2.0 (2017-03)**  
Electromagnetic compatibility and Radio Spectrum Matters (ERM); ElectroMagnetic Compatibility (EMC) standard for radio equipment and services; Part 1: Common technical requirements
- **EN 301 489-17 V3.2.0 (2017-03)**  
Electromagnetic compatibility and Radio spectrum Matters (ERM); ElectroMagnetic Compatibility (EMC) standard for radio equipment and services; Part 17: Specific conditions for 2,4 GHz wideband transmission systems and 5 GHz high performance RLAN equipment
- **EU 2015/863 (RoHS 3)**  
Declaration of Compliance – EU Directive 2015/863; Reduction of Hazardous Substances (RoHS)

This device is a 2.4 GHz wideband transmission system (transceiver), intended for use in all EU member states and EFTA countries, except in France and Italy where restrictive use applies.

In Italy the end-user should apply for a license at the national spectrum authorities in order to obtain authorization to use the device for setting up outdoor radio links and/or for supplying public access to telecommunications and/or network services.

This device may not be used for setting up outdoor radio links in France and in some areas the RF output power may be limited to 10 mW EIRP in the frequency range of 2454 – 2483.5 MHz. For detailed information the end-user should contact the national spectrum authority in France.

|                                    |   |
|------------------------------------|---|
| <b>Български [Bulgarian]</b>       | С настоящото [име на производителя] декларира, че това устройство [вид оборудване] е в съответствие със съществените изисквания и други приложими разпоредби на Директиви 2014/53/EC                          |
| <b>Hrvatski [Croatian]</b>         | [naziv proizvođača] ovim putem izjavljuje da je ovaj uređaj [vrsta opreme] sukladan osnovnim zahtjevima i ostalim bitnim odredbama Direktiva 2014/53/EU   |
| <b>Česky [Czech]</b>               | [Jméno výrobce] tímto prohlašuje, že tento [typ zařízení] je ve shodě se základními požadavky a dalšími příslušnými ustanoveními směrnice 2014/53/EU.   |
| <b>Dansk [Danish]</b>              | Undertegnede [fabrikantens navn] erklærer herved, at følgende udstyr [udstyrets typebetegnelse] overholder de væsentlige krav og øvrige relevante krav i direktiv 2014/53/EU.                                 |
| <b>Deutsch [German]</b>            | Hiermit erkläre [Name des Herstellers], dass sich das Gerät [Gerätetyp] in Übereinstimmung mit den grundlegenden Anforderungen und den übrigen einschlägigen Bestimmungen der Richtlinie 2014/53/EU befindet. |
| <b>Eesti [Estonian]</b>            | Käesolevaga kinnitab [tootja nimi] seadme [seadme tüüp] vastavust direktiivi 2014/53/EL põhinõuetele ja nimetatud direktiivist tulenevatele teistele asjakohastele sätetele.                                  |
| <b>English</b>                     | Hereby, [name of manufacturer], declares that this [type of equipment] is in compliance with the essential requirements and other relevant provisions of Directive 2014/53/EU.                                |
| <b>Español [Spanish]</b>           | Por medio de la presente [nombre del fabricante] declara que el [clase de equipo] cumple con los requisitos esenciales y cualesquiera otras disposiciones aplicables o exigibles de la Directiva 2014/53/UE.  |
| <b>Ελληνική [Greek]</b>            | ΜΕ ΤΗΝ ΠΑΡΟΥΣΑ [όνομα του κατασκευαστή] ΔΗΛΩΝΕΙ ΟΤΙ [εξοπλισμού] ΣΥΜΜΟΡΦΩΝΕΤΑΙ ΠΡΟΣ ΤΙΣ ΟΥΣΙΩΔΕΙΣ ΑΠΑΙΤΗΣΕΙΣ ΚΑΙ ΤΙΣ ΛΟΙΠΕΣ ΣΧΕΤΙΚΕΣ ΔΙΑΤΑΞΕΙΣ ΤΗΣ ΟΔΗΓΙΑΣ 2014/53/ΕΕ.  |
| <b>Français [French]</b>           | Par la présente [nom du fabricant] déclare que l'appareil [type d'appareil] est conforme aux exigences essentielles et aux autres dispositions pertinentes de la directive 2014/53/UE.                        |
| <b>Íslenska [Icelandic]</b>        | Hér, [Nafn framleiðanda], því yfir að þetta [gerð búnaðar] tæki er í samræmi við grunnkröfur og önnur viðeigandi ákvæði tilskipana 2014/53/ ESB   |
| <b>Italiano [Italian]</b>          | Con la presente [nome del costruttore] dichiara che questo [tipo di apparecchio] è conforme ai requisiti essenziali ed alle altre disposizioni pertinenti stabilite dalla direttiva 2014/53/UE.               |
| <b>Latviešu valoda [Latvian]</b>   | Ar šo [izgatavotājas nosaukums] deklarē, ka [iekārtas tips] atbilst Direktīvas 2014/53/ES būtiskajām prasībām un citiem ar to saistītajiem noteikumiem.   |
| <b>Lietuvių kalba [Lithuanian]</b> | Šiuo [gamintojo pavadinimas] deklaruoją, kad šis [įrangos tipas] atitinka esminius reikalavimus ir kitas 2014/53/ES Direktyvos nuostatas.   |

|                                |  |
|--------------------------------|--|
| <b>Nederlands [Dutch]</b>      | Hierbij verklaart <i>[naam van de fabrikant]</i> dat het toestel <i>[type van toestel]</i> in overeenstemming is met de essentiële eisen en de andere relevante bepalingen van richtlijn 2014/53/EU.       |
| <b>Malti [Maltese]</b>         | Hawnhekk, <i>[isem tal-manifattur]</i> , jiddikjara li dan <i>[il-mudel tal-prodott]</i> jikkonforma mal-htigijiet essenzjali u ma provvedimenti oħrajn rilevanti li hemm fid-Dirrettiva 2014/53/UE.       |
| <b>Magyar [Hungarian]</b>      | Alulírott, <i>[gyártó neve]</i> nyilatkozom, hogy a <i>[... típus]</i> megfelel a vonatkozó alapvető követelményeknek és az 2014/53/EU irányelv egyéb előírásainak.  |
| <b>Norsk [Norwegian]</b>       | Herved <i>[navnet på produsenten]</i> , erklærer at denne <i>[type utstyr]</i> enheten, er i samsvar med de grunnleggende kravene og andre relevante bestemmelser i direktivene 2014/53/EU                 |
| <b>Polski [Polish]</b>         | Niniejszym <i>[nazwa producenta]</i> oświadczam, że <i>[nazwa wyrobu]</i> jest zgodny z zasadniczymi wymogami oraz pozostałymi stosownymi postanowieniami Dyrektywy 2014/53/UE.                            |
| <b>Português [Portuguese]</b>  | <i>[Nome do fabricante]</i> declara que este <i>[tipo de equipamento]</i> está conforme com os requisitos essenciais e outras disposições da Directiva 2014/53/UE.   |
| <b>Română [Romanian]</b>       | Prin prezenta, <i>[numele producătorului]</i> declară că acest dispozitiv <i>[tipul de echipament]</i> este în conformitate cu cerințele esențiale și alte prevederi relevante ale Directivelor 2014/53/UE |
| <b>Slovenščina [Slovenian]</b> | <i>[Ime proizvajalca]</i> izjavlja, da je ta <i>[tip opreme]</i> v skladu z bistvenimi zahtevami in ostalimi relevantnimi določili direktive 2014/53/EU.   |
| <b>Slovenčina [Slovak]</b>     | <i>[Menovýrobcu]</i> týmto vyhlasuje, že <i>[typzariadenia]</i> spĺňa základné požiadavky a všetky príslušné ustanovenia Smernice 2014/53/EU.  |
| <b>Suomi [Finnish]</b>         | <i>[Valmistaja]</i> vakuuttaa täten että <i>[laitteen tyyppimerkintä]</i> tyyppinen laite on direktiivin 2014/53/EU oleellisten vaatimusten ja sitä koskevien direktiivin muiden ehtojen mukainen.         |
| <b>Svenska [Swedish]</b>       | Härmed intygar <i>[företag]</i> att denna <i>[utrustningstyp]</i> står i överensstämmelse med de väsentliga egenskapskrav och övriga relevanta bestämmelser som framgår av direktiv 2014/53/EU.            |

## 11.7.2 EU Declarations of Conformity

|                            |  |
|----------------------------|--|
| <b>Manufacturer</b>        | Laird Connectivity                           |
| <b>Products</b>            | RG186  |
| <b>Product Description</b> | LoRa/Wi-Fi/BT and BLE RF module              |
| <b>EU Directives</b>       | 2014/53/EU – Radio Equipment Directive (RED) |



### Reference standards used for presumption of conformity:

| Article Number | Requirement  | Reference standard(s)  |
|----------------|--|--|
| 3.1a           | Low voltage equipment safety                                     | EN 62368-1:2014  |
| 3.1b           | Protection requirements – Electromagnetic compatibility          | EN 301 489-1 v2.2.0 (2017-03)<br>EN 301 489-3 v2.1.1 (2017-03)<br>EN 301 489-17 v3.2.0 (2017-03)                             |
| 3.2            | Means of the efficient use of the radio frequency spectrum (ERM) | EN 300 220-1 v3.1.1 (2017-02)<br>EN 300 220-2 v3.1.1 (2017-02)<br>EN 300 328 v2.1.1 (2016-11)<br>EN 301 893-v2.1.1 (2017-05) |

### Declaration:

We, Laird Connectivity, declare under our sole responsibility that the essential radio test suites have been carried out and that the above product to which this declaration relates is in conformity with all the applicable essential requirements of Article 3 of the EU Radio Equipment Directive 2014/53/EU, when used for its intended purpose.

The minimum distance between the user and/or any bystander and the radiating structure of the transmitter is 20 cm.

|                                 |  |
|---------------------------------|--|
| Place of Issue:                 | Laird Connectivity<br>W66N220 Commerce Court, Cedarburg, WI 53012 USA<br>tel: +1-262-375-4400 fax: +1-262-364-2649 |
| Date of Issue:                  | 2020, June 3   |
| Name of Authorized Person:      | Ryan Urness  |
| Signature of Authorized Person: |  |

## 12 TELECOMMUNICATIONS REGULATORY AUTHORITY (TRA) COMPLIANCE

The RG186 has been tested for compliance with the relevant standards for the United Arab Emirates (UAE) market.

### 12.1 Labelling Requirements

The RG186 will contain the following information on the back of the gateway serial number label:

- Registered No (ER61585/18): Registration number allocated by the TRA to the equipment.
  - RG186 TRA Registered Number: ER61585/18
- Dealer No (DA72940/18): Dealer registration number allocated by the TRA to the dealer.
  - RG186 Dealer Registration Number: DA72940/18

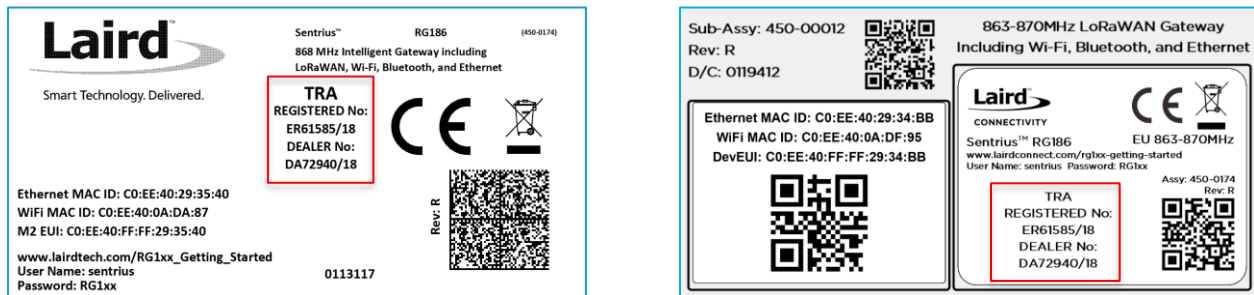

Figure 75: TRA Label Information (Standard GW – Left, AS923 & AU915 Region Supported/Latest Revision – Right)

## 13 REGION SUPPORTED LABELS

### 13.1 RG186 Version

The RG186 is compliant with UKCA & CE standards.



Figure 76: RG186 Region Supported Label

### 13.2 RG191 Version

The RG191 is the base for all current country variants:

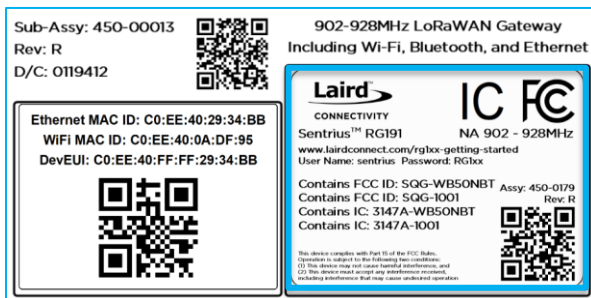

Figure 77: RG191 Region Supported Label

### 13.3 RG191+LTE Version

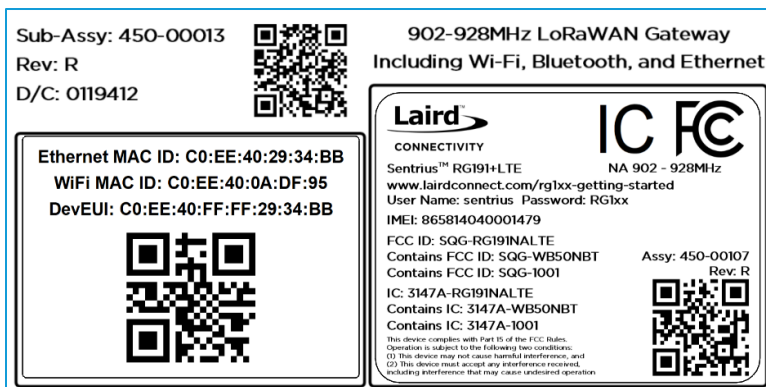

Figure 78: RG191+LTE Supported Label

## 13.4 AU915 & AS923 Regions

All region gateways will have a unique Product ID label which describes the region, any region certification label requirements, and frequency the gateway supports. This label is placed in the blue border shown in Figure 77. All labels are printed in black and white color.

### 13.4.1 Taiwan (TW)



Figure 79: Taiwan 923MHz Region Supported Label

### 13.4.2 New Zealand (NZ)



Figure 80: New Zealand 923MHz Region Supported Label

### 13.4.3 Hong Kong (HK)



Figure 81: Hong Kong 923MHz Region Supported Label



### 13.4.4 Australia (AU)



Figure 82: Australia 915 or 923MHz Region Supported Label (Frequency changes depending on setting)

### 13.4.5 Singapore (SG)

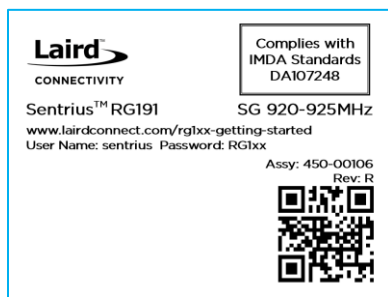

Figure 83: Singapore 923MHz Region Supported Label