

## Data sheet | Item number: 2005-7642

Multilevel installation terminal block; with operating slots; 4 mm<sup>2</sup>; L/L; Push-in CAGE CLAMP®; 4,00 mm<sup>2</sup>; gray

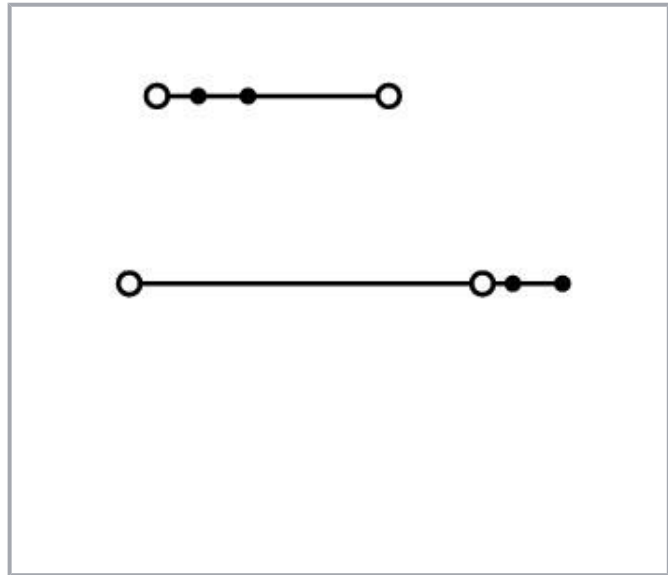

[www.wago.com/2005-7642](http://www.wago.com/2005-7642)

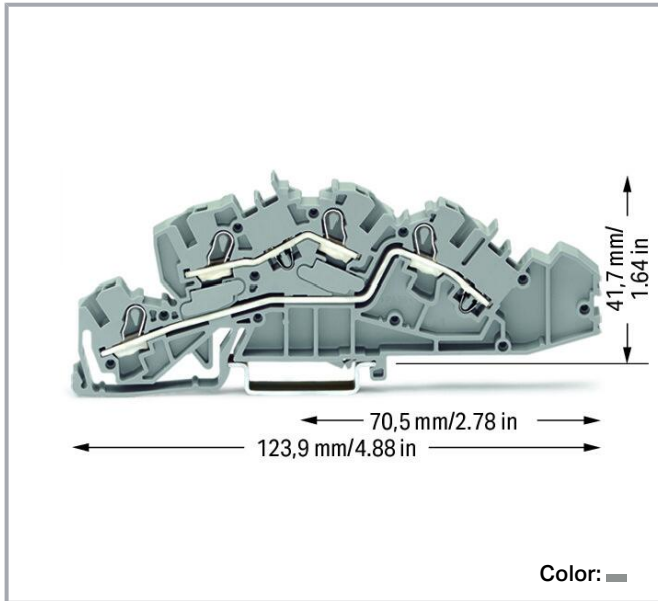

### Data

#### Electrical data

#### Ratings per IEC/EN

Ratings per	IEC/EN 60947-7-1
Nominal voltage (III/3)	400 V
Rated impulse voltage (III/3)	6 kV
Rated current	32 A
Current at conductor cross-section (max.) mm <sup>2</sup>	36 A
Legend (ratings)	(III / 3) ≙ Overvoltage category III / Pollution degree 3

#### Power loss

Power loss, per pole (potential)	1.024 W
Rated current I <sub>N</sub> for specified power loss	32 A
Resistance value for specified, current-dependent power loss	0.001 Ω

Subject to changes. Please also observe the further product documentation!

WAGO GmbH & Co. KG  
Hansastr. 27  
32423 Minden  
Phone: +49571 887-0 | Fax: +49571 887-169  
Email: [info.de@wago.com](mailto:info.de@wago.com) | Web: [www.wago.com](http://www.wago.com)

Do you have any questions about our products?  
We are always happy to take your call at +49 (571) 887-44222.



## Connection data

Connection points	4
Total number of potentials	2
Number of levels	3

## Connection 1

Connection technology	Push-in CAGE CLAMP®
Actuation type	Operating tool
Connectable conductor materials	Copper
Nominal cross-section	4 mm <sup>2</sup>
Solid conductor	0.5 ... 6 mm <sup>2</sup> / 20 ... 10 AWG
Solid conductor; push-in termination	1.5 ... 6 mm <sup>2</sup> / 14 ... 10 AWG
Fine-stranded conductor	0.5 ... 6 mm <sup>2</sup> / 20 ... 10 AWG
Fine-stranded conductor; with insulated ferrule	0.5 ... 4 mm <sup>2</sup> / 20 ... 12 AWG
Fine-stranded conductor; with ferrule; push-in termination	1.5 ... 4 mm <sup>2</sup> / 18 ... 12 AWG
Note (conductor cross-section)	Depending on the conductor characteristic, a conductor with a smaller cross-section can also be inserted via push-in termination.
Strip length	11 ... 13 mm / 0.43 ... 0.51 inches
Wiring direction	Front-entry wiring

## Physical data

Width	6.2 mm / 0.244 inches
Height	123.9 mm / 4.878 inches
Depth from upper-edge of DIN-rail	41.7 mm / 1.642 inches

## Mechanical Data

Potential marking	L/L
Mounting type	DIN-35 rail
Marking level	Center/side marking

## Material Data

Note (material data)	<a href="#">Information on material specifications can be found here</a>
Color	gray
Material group	I

Subject to changes. Please also observe the further product documentation!

Insulation material	Polyamide (PA66)
Flammability class per UL94	V0
Fire load	0.373 MJ
Weight	21.5 g

### Environmental requirements

Processing temperature	-35 ... +85 °C
Continuous operating temperature	-60 ... +105 °C

### Commercial data



Product Group	22 (TOPJOB S)
eCl@ss 10.0	27-14-11-25
eCl@ss 9.0	27-14-11-25
ETIM 8.0	EC001329
ETIM 7.0	EC001329
PU (SPU)	50 pcs
Packaging type	box
Country of origin	CN
GTIN	4055143042246
Customs tariff number	85369010000

### Environmental Product Compliance

RoHS Compliance Status	Compliant, No Exemption
------------------------	-------------------------

### Approvals / Certificates

#### General approvals



Logo	Approval	Additional Approval Text	Certificate name
	CCA DEKRA Certification B.V.	EN 60947	NTR-NL 6669
	CCA DEKRA Certification B.V.	EN 60947	2129185.01

### Declarations of conformity and manufacturer's declarations



Subject to changes. Please also observe the further product documentation!

WAGO GmbH & Co. KG  
 Hansastr. 27  
 32423 Minden  
 Phone: +49571 887-0 | Fax: +49571 887-169  
 Email: [info.de@wago.com](mailto:info.de@wago.com) | Web: [www.wago.com](http://www.wago.com)

Do you have any questions about our products?  
 We are always happy to take your call at +49 (571) 887-44222.

Logo	Approval	Additional Approval Text	Certificate name
	EU-Declaration of Conformity WAGO GmbH & Co. KG	-	-
	UK-Declaration of Conformity WAGO GmbH & Co. KG	-	-

#### Approvals for marine applications

Logo	Approval	Additional Approval Text	Certificate name
	ABS American Bureau of Shipping	EN 60947	20- HG1941090- PDA
	DNV GL Det Norske Veritas, Germanischer Lloyd	-	TAE00001V2
	LR Lloyds Register	EN 60947	91/20112 (E9)

#### Required accessories

##### End plate

End plate



Item no.: 2005-7692

End and intermediate plate; 1 mm thick; orange

[www.wago.com/2005-7692](http://www.wago.com/2005-7692)

#### Optional accessories

##### Carrier rail

Mounting accessories



Item no.: 210-197

Steel carrier rail; 35 x 15 mm; 1.5 mm thick; 2 m long; slotted; similar to EN 60715; silver-colored

[www.wago.com/210-197](http://www.wago.com/210-197)

Subject to changes. Please also observe the further product documentation!

WAGO GmbH & Co. KG

Hansastr. 27







32423 Minden

Phone: +49571 887-0 | Fax: +49571 887-169



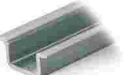

Email: [info.de@wago.com](mailto:info.de@wago.com) | Web: [www.wago.com](http://www.wago.com)

Do you have any questions about our products?



We are always happy to take your call at +49 (571) 887-44222.

	<b>Item no.: 210-198</b> Copper carrier rail; 35 x 15 mm; 2.3 mm thick; 2 m long; unslotted; according to EN 60715; copper-colored	<a href="http://www.wago.com/210-198">www.wago.com/210-198</a>
	<b>Item no.: 210-113</b> Steel carrier rail; 35 x 7.5 mm; 1 mm thick; 2 m long; unslotted; according to EN 60715; silver-colored	<a href="http://www.wago.com/210-113">www.wago.com/210-113</a>
	<b>Item no.: 210-118</b> Steel carrier rail; 35 x 15 mm; 2.3 mm thick; 2 m long; unslotted; according to EN 60715; silver-colored	<a href="http://www.wago.com/210-118">www.wago.com/210-118</a>
	<b>Item no.: 210-112</b> Steel carrier rail; 35 x 7.5 mm; 1 mm thick; 2 m long; slotted; according to EN 60715; "Hole width 25 mm; silver-colored	<a href="http://www.wago.com/210-112">www.wago.com/210-112</a>
	<b>Item no.: 210-114</b> Steel carrier rail; 35 x 15 mm; 1.5 mm thick; 2 m long; unslotted; similar to EN 60715; silver-colored	<a href="http://www.wago.com/210-114">www.wago.com/210-114</a>
	<b>Item no.: 210-115</b> Steel carrier rail; 35 x 7.5 mm; 1 mm thick; 2 m long; slotted; according to EN 60715; "Hole width 18 mm; silver-colored	<a href="http://www.wago.com/210-115">www.wago.com/210-115</a>
	<b>Item no.: 210-196</b> Aluminum carrier rail; 35 x 8.2 mm; 1.6 mm thick; 2 m long; unslotted; similar to EN 60715; silver-colored	<a href="http://www.wago.com/210-196">www.wago.com/210-196</a>

## Ferrule

Ferrule		
	<b>Item no.: 216-263</b> Ferrule; Sleeve for 1 mm <sup>2</sup> / AWG 18; insulated; electro-tin plated; electrolytic copper; gastight crimped; acc. to DIN 46228, Part 4/09.90; red	<a href="http://www.wago.com/216-263">www.wago.com/216-263</a>
	<b>Item no.: 216-266</b> Ferrule; Sleeve for 2.5 mm <sup>2</sup> / AWG 14; insulated; electro-tin plated; electrolytic copper; gastight crimped; acc. to DIN 46228, Part 4/09.90; blue	<a href="http://www.wago.com/216-266">www.wago.com/216-266</a>
	<b>Item no.: 216-264</b> Ferrule; Sleeve for 1.5 mm <sup>2</sup> / AWG 16; insulated; electro-tin plated; electrolytic copper; gastight crimped; acc. to DIN 46228, Part 4/09.90; black	<a href="http://www.wago.com/216-264">www.wago.com/216-264</a>
	<b>Item no.: 216-262</b> Ferrule; Sleeve for 0.75 mm <sup>2</sup> / 18 AWG; insulated; electro-tin plated; electrolytic copper; gastight crimped; acc. to DIN 46228, Part 4/09.90; gray	<a href="http://www.wago.com/216-262">www.wago.com/216-262</a>
	<b>Item no.: 216-267</b> Ferrule; Sleeve for 4 mm <sup>2</sup> / AWG 12; insulated; electro-tin plated; electrolytic copper; gastight crimped; acc. to DIN 46228, Part 4/09.90; gray	<a href="http://www.wago.com/216-267">www.wago.com/216-267</a>

## Jumpers

Jumper		
	<b>Item no.: 210-123</b> Wire commoning chain; insulated; blue	<a href="http://www.wago.com/210-123">www.wago.com/210-123</a>
	<b>Item no.: 2004-403</b> Jumper; 3-way; insulated; light gray	<a href="http://www.wago.com/2004-403">www.wago.com/2004-403</a>
	<b>Item no.: 2004-406</b>	

Subject to changes. Please also observe the further product documentation!

Jumper; 6-way; insulated; light gray

[www.wago.com/2004-406](http://www.wago.com/2004-406)



**Item no.: 2004-405/011-000**  
Star point jumper; 3-way; insulated; light gray

[www.wago.com/2004-405/011-000](http://www.wago.com/2004-405/011-000)



**Item no.: 2004-402**  
Jumper; 2-way; insulated; light gray

[www.wago.com/2004-402](http://www.wago.com/2004-402)



**Item no.: 2004-407**  
Jumper; 7-way; insulated; light gray

[www.wago.com/2004-407](http://www.wago.com/2004-407)



**Item no.: 2004-408**  
Jumper; 8-way; insulated; light gray

[www.wago.com/2004-408](http://www.wago.com/2004-408)



**Item no.: 2004-404**  
Jumper; 4-way; insulated; light gray

[www.wago.com/2004-404](http://www.wago.com/2004-404)



**Item no.: 2004-405**  
Jumper; 5-way; insulated; light gray

[www.wago.com/2004-405](http://www.wago.com/2004-405)



**Item no.: 2004-409**  
Jumper; 9-way; insulated; light gray

[www.wago.com/2004-409](http://www.wago.com/2004-409)



**Item no.: 2004-433**  
Jumper; from 1 to 3; insulated; light gray

[www.wago.com/2004-433](http://www.wago.com/2004-433)



**Item no.: 2004-436**  
Jumper; from 1 to 6; insulated; light gray

[www.wago.com/2004-436](http://www.wago.com/2004-436)



**Item no.: 2004-410**  
Jumper; 10-way; insulated; light gray

[www.wago.com/2004-410](http://www.wago.com/2004-410)



**Item no.: 2004-406/020-000**  
Delta jumper; insulated; light gray

[www.wago.com/2004-406/020-000](http://www.wago.com/2004-406/020-000)



**Item no.: 2004-438**  
Jumper; from 1 to 8; insulated; light gray

[www.wago.com/2004-438](http://www.wago.com/2004-438)



**Item no.: 2004-440**  
Jumper; from 1 to 10; insulated; light gray

[www.wago.com/2004-440](http://www.wago.com/2004-440)



**Item no.: 2004-435**  
Jumper; from 1 to 5; insulated; light gray

[www.wago.com/2004-435](http://www.wago.com/2004-435)



**Item no.: 2004-437**  
Jumper; from 1 to 7; insulated; light gray

[www.wago.com/2004-437](http://www.wago.com/2004-437)



**Item no.: 2004-439**  
Jumper; from 1 to 9; insulated; light gray

[www.wago.com/2004-439](http://www.wago.com/2004-439)



**Item no.: 2004-434**  
Jumper; from 1 to 4; insulated; light gray

[www.wago.com/2004-434](http://www.wago.com/2004-434)

Subject to changes. Please also observe the further product documentation!

**Item no.: 210-103**

Wire commoning chain; insulated; black

[www.wago.com/210-103](http://www.wago.com/210-103)**Mounting**

Cover carrier

**Item no.: 709-169**

Cover carrier; Type 3; gray

[www.wago.com/709-169](http://www.wago.com/709-169)

Cover

**Item no.: 709-156**

Cover; Type 3; suitable for cover carrier, type 3; 1 m long; transparent

[www.wago.com/709-156](http://www.wago.com/709-156)**Mounting accessories****Item no.: 2009-305**

Busbar carrier; with end stop function and detachable separator plate; for DIN 35 rail; 7.5 mm thick; blue

[www.wago.com/2009-305](http://www.wago.com/2009-305)**Item no.: 2009-304**

Busbar carrier; not suitable for use as end stop; for DIN 35 rail; 1.5 mm thick; blue

[www.wago.com/2009-304](http://www.wago.com/2009-304)**Marking accessories**

Marking strip

**Item no.: 2009-110**

Marking strips; for Smart Printer; on reel; not stretchable; plain; snap-on type; white

[www.wago.com/2009-110](http://www.wago.com/2009-110)

Marker carrier

**Item no.: 2009-198**

Adaptor; gray

[www.wago.com/2009-198](http://www.wago.com/2009-198)

Marker

**Item no.: 2009-115/000-002**

WMB-Inline; for Smart Printer; 1500 pieces on roll; stretchable 5 - 5.2 mm; plain; snap-on type; yellow

[www.wago.com/2009-115/000-002](http://www.wago.com/2009-115/000-002)**Item no.: 2009-115/000-007**

WMB-Inline; for Smart Printer; 1500 pieces on roll; stretchable 5 - 5.2 mm; plain; snap-on type; gray

[www.wago.com/2009-115/000-007](http://www.wago.com/2009-115/000-007)**Item no.: 2009-115/000-017**

WMB-Inline; for Smart Printer; 1500 pieces on roll; stretchable 5 - 5.2 mm; plain; snap-on type; light green

[www.wago.com/2009-115/000-017](http://www.wago.com/2009-115/000-017)**Item no.: 2009-115/000-023**

WMB-Inline; for Smart Printer; 1500 pieces on roll; stretchable 5 - 5.2 mm; plain; snap-on type; green

[www.wago.com/2009-115/000-023](http://www.wago.com/2009-115/000-023)**Item no.: 2009-115/000-024**

WMB-Inline; for Smart Printer; 1500 pieces on roll; stretchable 5 - 5.2 mm; plain; snap-on type; violet

[www.wago.com/2009-115/000-024](http://www.wago.com/2009-115/000-024)

Subject to changes. Please also observe the further product documentation!

WAGO GmbH &amp; Co. KG

Hansastr. 27











32423 Minden

Phone: +49571 887-0 | Fax: +49571 887-169

Email: [info.de@wago.com](mailto:info.de@wago.com) | Web: [www.wago.com](http://www.wago.com)

Do you have any questions about our products?

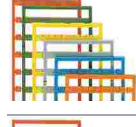
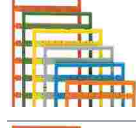
We are always happy to take your call at +49 (571) 887-44222.

	<p><b>Item no.: 2009-145/000-006</b> Mini-WSB Inline; for Smart Printer; 1700 pieces on roll; stretchable 5 - 5.2 mm; plain; snap-on type; blue</p>	<p><a href="http://www.wago.com/2009-145/000-006">www.wago.com/2009-145/000-006</a></p>
	<p><b>Item no.: 2009-145</b> Mini-WSB Inline; for Smart Printer; 1700 pieces on roll; stretchable 5 - 5.2 mm; plain; snap-on type; white</p>	<p><a href="http://www.wago.com/2009-145">www.wago.com/2009-145</a></p>
	<p><b>Item no.: 2009-145/000-002</b> Mini-WSB Inline; for Smart Printer; 1700 pieces on roll; stretchable 5 - 5.2 mm; plain; snap-on type; yellow</p>	<p><a href="http://www.wago.com/2009-145/000-002">www.wago.com/2009-145/000-002</a></p>
	<p><b>Item no.: 2009-145/000-007</b> Mini-WSB Inline; for Smart Printer; 1700 pieces on roll; stretchable 5 - 5.2 mm; plain; snap-on type; gray</p>	<p><a href="http://www.wago.com/2009-145/000-007">www.wago.com/2009-145/000-007</a></p>
	<p><b>Item no.: 2009-145/000-005</b> Mini-WSB Inline; for Smart Printer; 1700 pieces on roll; stretchable 5 - 5.2 mm; plain; snap-on type; red</p>	<p><a href="http://www.wago.com/2009-145/000-005">www.wago.com/2009-145/000-005</a></p>
	<p><b>Item no.: 2009-145/000-012</b> Mini-WSB Inline; for Smart Printer; 1700 pieces on roll; stretchable 5 - 5.2 mm; plain; snap-on type; orange</p>	<p><a href="http://www.wago.com/2009-145/000-012">www.wago.com/2009-145/000-012</a></p>
	<p><b>Item no.: 2009-145/000-023</b> Mini-WSB Inline; for Smart Printer; 1700 pieces on roll; stretchable 5 - 5.2 mm; plain; snap-on type; green</p>	<p><a href="http://www.wago.com/2009-145/000-023">www.wago.com/2009-145/000-023</a></p>
	<p><b>Item no.: 2009-145/000-024</b> Mini-WSB Inline; for Smart Printer; 1700 pieces on roll; stretchable 5 - 5.2 mm; plain; snap-on type; violet</p>	<p><a href="http://www.wago.com/2009-145/000-024">www.wago.com/2009-145/000-024</a></p>
	<p><b>Item no.: 2009-115</b> WMB-Inline; for Smart Printer; 1500 pieces on roll; stretchable 5 - 5.2 mm; plain; snap-on type; white</p>	<p><a href="http://www.wago.com/2009-115">www.wago.com/2009-115</a></p>
	<p><b>Item no.: 248-501/000-006</b> Mini-WSB marking card; as card; not stretchable; plain; snap-on type; blue</p>	<p><a href="http://www.wago.com/248-501/000-006">www.wago.com/248-501/000-006</a></p>
	<p><b>Item no.: 248-501/000-007</b> Mini-WSB marking card; as card; not stretchable; plain; snap-on type; gray</p>	<p><a href="http://www.wago.com/248-501/000-007">www.wago.com/248-501/000-007</a></p>
	<p><b>Item no.: 248-501/000-002</b> Mini-WSB marking card; as card; not stretchable; plain; snap-on type; yellow</p>	<p><a href="http://www.wago.com/248-501/000-002">www.wago.com/248-501/000-002</a></p>

Subject to changes. Please also observe the further product documentation!





**Item no.: 248-501/000-012**  
Mini-WSB marking card; as card; not stretchable; plain; snap-on type; orange

[www.wago.com/248-501/000-012](http://www.wago.com/248-501/000-012)



**Item no.: 248-501**  
Mini-WSB marking card; as card; not stretchable; plain; snap-on type; white

[www.wago.com/248-501](http://www.wago.com/248-501)



**Item no.: 248-501/000-017**  
Mini-WSB marking card; as card; not stretchable; plain; snap-on type; light green

[www.wago.com/248-501/000-017](http://www.wago.com/248-501/000-017)



**Item no.: 248-501/000-005**  
Mini-WSB marking card; as card; not stretchable; plain; snap-on type; red

[www.wago.com/248-501/000-005](http://www.wago.com/248-501/000-005)



**Item no.: 248-501/000-024**  
Mini-WSB marking card; as card; not stretchable; plain; snap-on type; violet

[www.wago.com/248-501/000-024](http://www.wago.com/248-501/000-024)



**Item no.: 248-501/000-023**  
Mini-WSB marking card; as card; not stretchable; plain; snap-on type; green

[www.wago.com/248-501/000-023](http://www.wago.com/248-501/000-023)



**Item no.: 793-5501/000-007**  
WMB marking card; as card; for terminal block width 5 - 17.5 mm; stretchable 5 - 5.2 mm; plain; snap-on type; gray

[www.wago.com/793-5501/000-007](http://www.wago.com/793-5501/000-007)



**Item no.: 793-5501/000-012**  
WMB marking card; as card; for terminal block width 5 - 17.5 mm; stretchable 5 - 5.2 mm; plain; snap-on type; orange

[www.wago.com/793-5501/000-012](http://www.wago.com/793-5501/000-012)



**Item no.: 793-5501/000-014**  
WMB marking card; as card; for terminal block width 5 - 17.5 mm; stretchable 5 - 5.2 mm; plain; snap-on type; brown

[www.wago.com/793-5501/000-014](http://www.wago.com/793-5501/000-014)

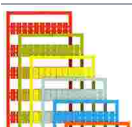

**Item no.: 793-5501/000-017**  
WMB marking card; as card; for terminal block width 5 - 17.5 mm; stretchable 5 - 5.2 mm; plain; snap-on type; light green

[www.wago.com/793-5501/000-017](http://www.wago.com/793-5501/000-017)

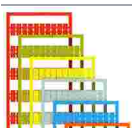

**Item no.: 793-5501/000-023**  
WMB marking card; as card; for terminal block width 5 - 17.5 mm; stretchable 5 - 5.2 mm; plain; snap-on type; green

[www.wago.com/793-5501/000-023](http://www.wago.com/793-5501/000-023)

**Item no.: 793-5501/000-024**

Subject to changes. Please also observe the further product documentation!



WMB marking card; as card; for terminal block width 5 - 17.5 mm; stretchable 5 - 5.2 mm; plain; snap-on type; violet [www.wago.com/793-5501/000-024](http://www.wago.com/793-5501/000-024)



**Item no.: 793-501/000-002**  
WMB marking card; as card; not stretchable; plain; snap-on type; yellow [www.wago.com/793-501/000-002](http://www.wago.com/793-501/000-002)



**Item no.: 793-501/000-007**  
WMB marking card; as card; not stretchable; plain; snap-on type; gray [www.wago.com/793-501/000-007](http://www.wago.com/793-501/000-007)



**Item no.: 793-501/000-017**  
WMB marking card; as card; not stretchable; plain; snap-on type; light green [www.wago.com/793-501/000-017](http://www.wago.com/793-501/000-017)



**Item no.: 793-501/000-012**  
WMB marking card; as card; not stretchable; plain; snap-on type; orange [www.wago.com/793-501/000-012](http://www.wago.com/793-501/000-012)



**Item no.: 793-501/000-023**  
WMB marking card; as card; not stretchable; plain; snap-on type; green [www.wago.com/793-501/000-023](http://www.wago.com/793-501/000-023)



**Item no.: 793-501/000-006**  
WMB marking card; as card; not stretchable; plain; snap-on type; blue [www.wago.com/793-501/000-006](http://www.wago.com/793-501/000-006)



**Item no.: 793-501/000-005**  
WMB marking card; as card; not stretchable; plain; snap-on type; red [www.wago.com/793-501/000-005](http://www.wago.com/793-501/000-005)



**Item no.: 793-501**  
WMB marking card; as card; not stretchable; plain; snap-on type; white [www.wago.com/793-501](http://www.wago.com/793-501)



**Item no.: 793-501/000-024**  
WMB marking card; as card; not stretchable; plain; snap-on type; violet [www.wago.com/793-501/000-024](http://www.wago.com/793-501/000-024)



**Item no.: 793-5501/000-005**  
WMB marking card; as card; for terminal block width 5 - 17.5 mm; stretchable 5 - 5.2 mm; plain; snap-on type; red [www.wago.com/793-5501/000-005](http://www.wago.com/793-5501/000-005)

Subject to changes. Please also observe the further product documentation!



**Item no.:** 793-5501/000-002

WMB marking card; as card; for terminal block width 5 - 17.5 mm; stretchable 5 - 5.2 mm; plain; snap-on type; yellow [www.wago.com/793-5501/000-002](http://www.wago.com/793-5501/000-002)



**Item no.:** 793-5501/000-006

WMB marking card; as card; for terminal block width 5 - 17.5 mm; stretchable 5 - 5.2 mm; plain; snap-on type; blue [www.wago.com/793-5501/000-006](http://www.wago.com/793-5501/000-006)



**Item no.:** 793-5501

WMB marking card; as card; for terminal block width 5 - 17.5 mm; stretchable 5 - 5.2 mm; plain; snap-on type; white [www.wago.com/793-5501](http://www.wago.com/793-5501)



**Item no.:** 2009-115/000-012

WMB-Inline; for Smart Printer; 1500 pieces on roll; stretchable 5 - 5.2 mm; plain; snap-on type; orange [www.wago.com/2009-115/000-012](http://www.wago.com/2009-115/000-012)



**Item no.:** 2009-115/000-006

WMB-Inline; for Smart Printer; 1500 pieces on roll; stretchable 5 - 5.2 mm; plain; snap-on type; blue [www.wago.com/2009-115/000-006](http://www.wago.com/2009-115/000-006)



**Item no.:** 2009-115/000-005

WMB-Inline; for Smart Printer; 1500 pieces on roll; stretchable 5 - 5.2 mm; plain; snap-on type; red [www.wago.com/2009-115/000-005](http://www.wago.com/2009-115/000-005)

**Group marker carrier**



**Item no.:** 2009-193

Group marker carrier; gray [www.wago.com/2009-193](http://www.wago.com/2009-193)



**Item no.:** 2009-192

Group marker carrier; gray [www.wago.com/2009-192](http://www.wago.com/2009-192)



**Item no.:** 2009-191

Group marker carrier; gray [www.wago.com/2009-191](http://www.wago.com/2009-191)

**Insulation stop**

Insulation stop



**Item no.:** 2004-172

Insulation stop; 0.75 - 1 mm<sup>2</sup>; 5 pieces/strip; dark gray [www.wago.com/2004-172](http://www.wago.com/2004-172)



**Item no.:** 2004-171

Insulation stop; 0.25 - 0.5 mm<sup>2</sup>; 5 pieces/strip; light gray [www.wago.com/2004-171](http://www.wago.com/2004-171)

**Testing and measuring**

Testing accessories



**Item no.:** 2009-174

Test plug adapter; for 4 mm Ø test plugs; for testing TOPJOB®S rail-mounted terminal blocks; gray [www.wago.com/2009-174](http://www.wago.com/2009-174)

Subject to changes. Please also observe the further product documentation!



**Item no.: 2009-182**

Testing tap; for max. 2.5 mm<sup>2</sup>; tool-free connection for individual test wires 0.08 - 2.5 mm; gray

[www.wago.com/2009-182](http://www.wago.com/2009-182)



**Item no.: 210-136**

Test plug; 2 mm Ø; with 500 mm cable; red

[www.wago.com/210-136](http://www.wago.com/210-136)

## Tool

Operating tool



**Item no.: 2009-310**

Operating tool; Blades: 3.5 x 0.5 mm and 5.5 x 0.8 mm; for TOPJOB®S installation terminal blocks; green

[www.wago.com/2009-310](http://www.wago.com/2009-310)



**Item no.: 2009-309**

Operating tool; Blades: 3.5 x 0.5 mm and 2.5 x 0.4 mm; for TOPJOB®S installation terminal blocks

[www.wago.com/2009-309](http://www.wago.com/2009-309)



**Item no.: 210-658**

Operating tool; Blade: 3.5 x 0.5 mm; with a partially insulated shaft; angled; short; multicoloured

[www.wago.com/210-658](http://www.wago.com/210-658)



**Item no.: 210-720**

Operating tool; Blade: 3.5 x 0.5 mm; with a partially insulated shaft; multicoloured

[www.wago.com/210-720](http://www.wago.com/210-720)

## Downloads

### Documentation

#### Bid Text

2005-7642 X81 - Datei	2019 Feb 19	xml 3.8 kB	Download
--------------------------	-------------	---------------	----------

2005-7642 docx - Datei	2018 Aug 7	docx 15.0 kB	Download
---------------------------	------------	-----------------	----------

#### Additional Information

Technical Section Technical explanations		pdf 2.2 MB	Download
---	--	---------------	----------

## CAD/CAE-Data

### CAD data

Subject to changes. Please also observe the further product documentation!

2D/3D Models 2005-7642	<a href="#">URL</a>	<a href="#">Download</a>
<b>CAE data</b>		
EPLAN Data Portal 2005-7642	<a href="#">URL</a>	<a href="#">Download</a>
WSCAD Universe 2005-7642	<a href="#">URL</a>	<a href="#">Download</a>
ZUKEN Portal 2005-7642	<a href="#">URL</a>	<a href="#">Download</a>

## Environmental Product Compliance

### Compliance Search

Environmental Product Compliance 2005-7642	<a href="#">URL</a>	<a href="#">Download</a>
Multilevel installation terminal block; with operating slots; 4 mm <sup>2</sup> ; L/L; Push-in CAGE CLAMP®; 4,00 mm <sup>2</sup> ; gray		

## Installation Notes

### Conductor termination



All conductor types at a glance

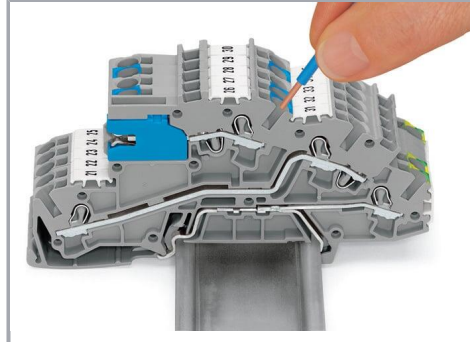

Inserting a conductor via push-in termination.

Solid conductors with cross-sections from either one size above, or up to two sizes below, the rated cross-section can be simply pushed in – no tools needed.

Subject to changes. Please also observe the further product documentation!

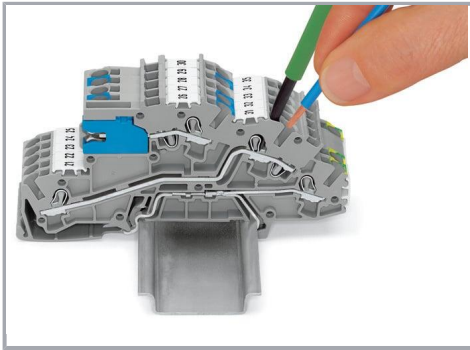

#### Inserting a conductor via operating tool.

Connecting fine-stranded conductors without ferrules, or small cross-sectional conductors that cannot be pushed in, is performed similarly to the original CAGE CLAMP® – just use an operating tool.

#### Testing

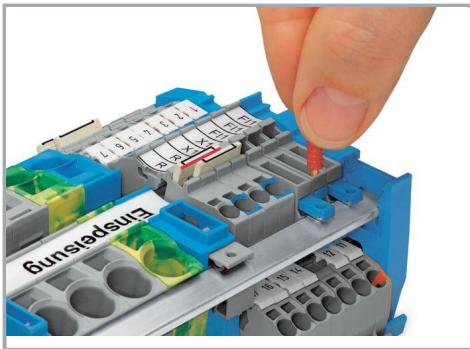

#### Busbar

Subject to changes. Please also observe the further product documentation!

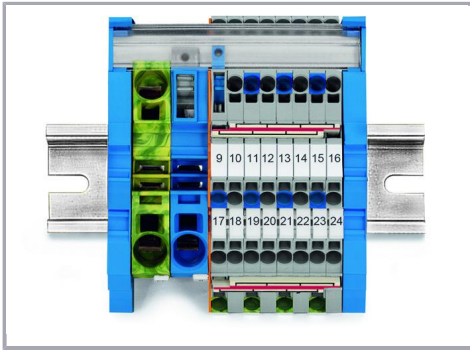

Mounting busbars on busbar carriers: Insert busbar ends onto large busbar carriers (2009-305) or onto supply terminal blocks with an integrated busbar carrier.

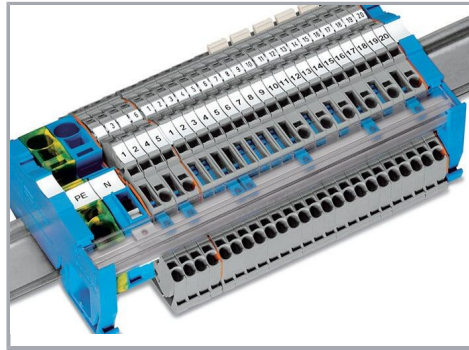

The busbar transparent cover (Item No. 777-303) protects the busbar against accidental contact and makes it easy to see which terminal blocks are connected to the busbar.

## Product family

### TOPJOB® S

TOPJOB® S: In various industrial applications and modern building installations, WAGO's wide and versatile range of rail-mount terminal blocks provides more than just reliable electrical connections.

[Show all products from the family](#)

Subject to changes. Please also observe the further product documentation!