

FRONT VIEW
SCALE 2:1

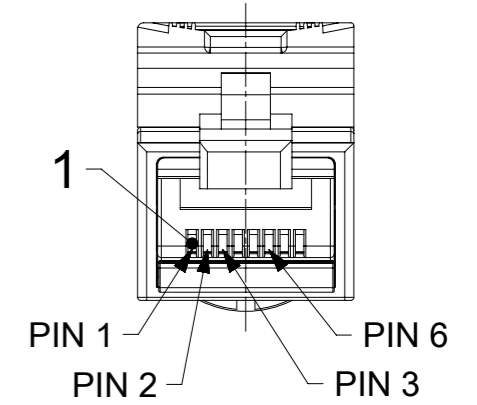

FRONT VIEW
SCALE 2:1

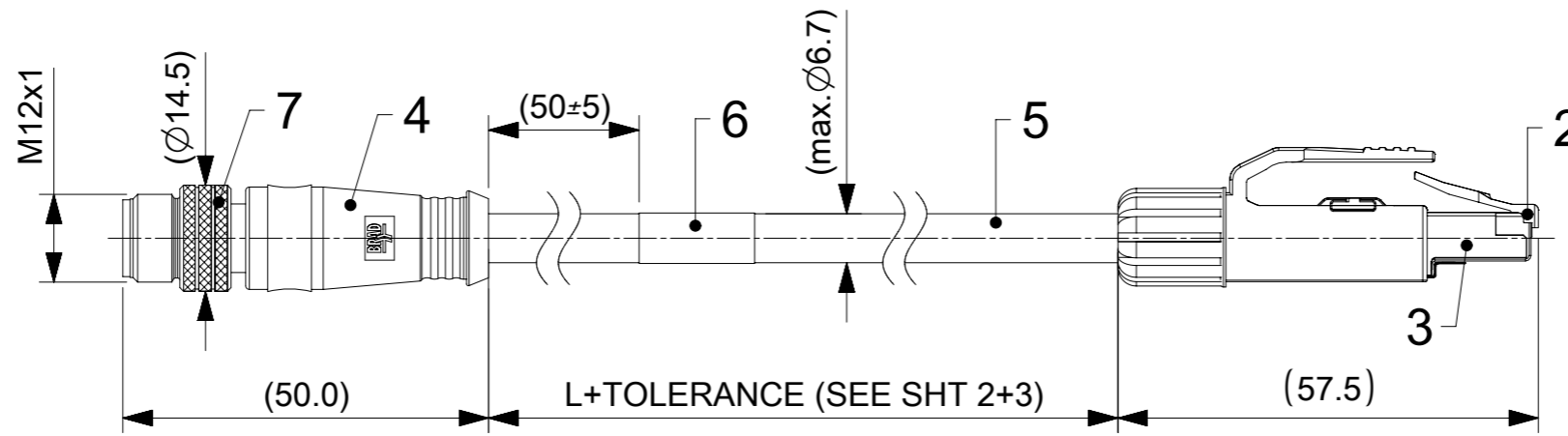
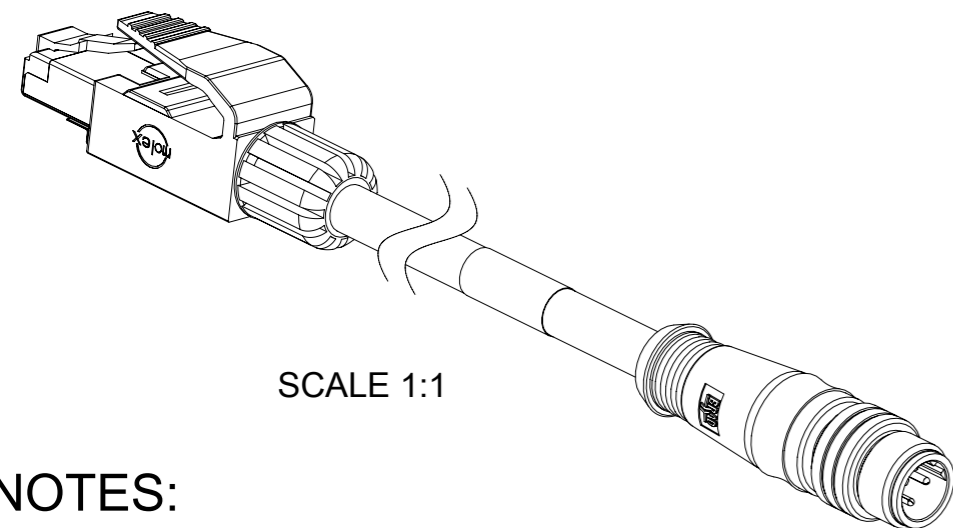

SCALE 1:1

WIRING DIAGRAM

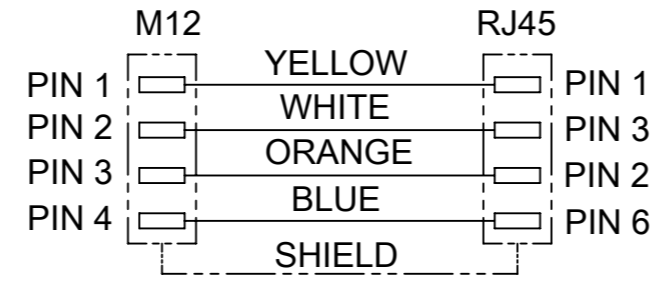

BOM

ITEM	QTY.	DESCRIPTION	MATERIAL	FINISH/COLOR
9	4	CONTACTS M12 MALE	BRASS	SELECTIVE GOLD
8	1	INSERT 4P MALE	PUR	BLACK
7	1	COUPLING NUT M12 MALE	BRASS	NICKEL
6	1	LABEL 50x69.8	VINYL	WHITE
5	-	CABLE	SEE SHEET 2	---
4	-	OVERMOLD	TPU	BLACK
3	1	SHIELD	BRASS	TIN
2	1	PLUG RJ45 TRANSPARENT	POLYCARBONATE	---
1	4 or 8	CONTACT RJ45 MALE	PHOSPHOR BRONZE	SELECTIVE GOLD

NOTES:

- ELECTRICAL DATA:
MAX. VOLTAGE RATING 60 VDC
MAX. CURRENT PER CONTACT 1.5 A
- ENVIRONMENTAL:
OPERATING TEMPERATURE SEE SHEET 2
INDEX OF PROTECTION RJ45: IP20
INDEX OF PROTECTION M12: IP67
- FOR MORE INFORMATION SEE PRODUCT SPECIFICATION 1201080202 PS P00

THIS DRAWING CONTAINS INFORMATION THAT IS PROPRIETARY TO MOLEX ELECTRONIC TECHNOLOGIES, LLC AND SHOULD NOT BE USED WITHOUT WRITTEN PERMISSION

SYMBOLS: DIMENSION UNITS: mm SCALE: 1:1

GENERAL TOLERANCES (UNLESS SPECIFIED): ANGULAR TOL ± 1.0°

CURRENT REV DESC: CORRECTION TO OLD RJ45 DESIGN

EC NO: 639128
DRWN: RSCHIEBER 2020/05/20
CHK'D: RSILLER 2020/06/08
APPR: RSILLER 2020/06/08

INITIAL REVISION:
DRWN: JMARSZALEK 2015/07/07
APPR: RSILLER 2020/05/12

THIRD ANGLE PROJECTION

molex

CSE M12 RJ45 4P DC MA STR MA STR XM

PRODUCT CUSTOMER DRAWING

DOCUMENT NUMBER: 1201080256 DOC TYPE: PSD DOC PART: 000 REVISION: A1









MATERIAL NUMBER: SEE SHEET 3 CUSTOMER: GENERAL MARKET SHEET NUMBER: 1 OF 3

PART LIST

No.	Part No.	Engineering No.	L (Cable Length)
1	1201080203	E16A06011M020	2m
2	1201080256	E16A06011M010	1m
3	1201080257	E16A06011M050	5m
4	1201080258	E16A06011M100	10m
5	1201080259	E16A06011M150	15m
6	1201080260	E16A06011M200	20m
7	1201080261	E16A06011M250	25m
8	1201080262	E16A06011M300	30m
9	1201080263	E16A06011M500	50m
10	1201080285	E16A06011M060	6m
11	1201080286	E16A06011M080	8m
12	1201080289	E16A06011M040	4m
13	1201080290	E16A06011M090	9m
14	1201080291	E16A06011M120	12m
15	1201080292	E16A06011M140	14m
16	1201080293	E16A06011M180	18m
17	1201080294	E16A06011M700	70m
18	1201080521	E16A06012M010	1m
19	1201080522	E16A06012M020	2m
20	1201080524	E16A06012M100	10m
21	1201088120	E16A06011M005	0.5m
22	1201088121	E16A06011M030	3m
23	1201088122	E16A06011M070	7m
24	1201088123	E16A06011M230	23m
25	1201088196	E16A06011M900	90m
26	1201088199	E16A06011M400	40m
27	1201088200	E16A06011T100	10m
28	1201088255	E16A06011M002	0.2m
29	1201088266	E16A06012M020H	2m
30	1201088272	E16A06012M010H	1m
31	1201088273	E16A06012M050H	5m
32	1201088274	E16A06012M100H	10m
33	1201088275	E16A06012M150H	15m
34	1201088276	E16A06012M200H	20m
35	1201088277	E16A06012M250H	25m

No.	Part No.	Engineering No.	L (Cable Length)
36	1201088278	E16A06012M300H	30m
37	1201088279	E16A06012M500H	50m
38	1201088286	E16A06012M700H	70m
39	1201088290	E16A06012M005H	0.5m
40	1201088291	E16A06012M900H	90m
41	1201088292	E16A06012M400H	40m
42	1201088299	E16A06012M002H	0.2m
43	1201088329	E16A06012M010	1m
44	1201088330	E16A06012M020	2m
45	1201088331	E16A06012M030	3m
46	1201088332	E16A06012M040	4m
47	1201088333	E16A06012M050	5m
48	1201088334	E16A06012M060	6m
49	1201088335	E16A06012M080	8m
50	1201088336	E16A06012M090	9m
51	1201088338	E16A06012M120	12m
52	1201088339	E16A06012M150	15m
53	1201088340	E16A06012M200	20m
54	1201088341	E16A06012M250	25m
55	1201088342	E16A06012M300	30m
56	1201088343	E16A06012M350	35m
57	1201088344	E16A06012M400	40m
58	1201088345	E16A06012M450	45m
59	1201088346	E16A06012M500	50m
60	1201088347	E16A06012M550	55m
61	1201088348	E16A06012M600	60m
62	1201088349	E16A06012M650	65m
63	1201088350	E16A06012M700	70m
64	1201088351	E16A06012M750	75m
65	1201088352	E16A06012M800	80m
66	1201088388	E16A06011M350	35m
67	1201088399	E16A06012M030H	3m
68	1201088400	E16A06012M600H	60m
69	1201088401	E16A06012M1K0H	100m
70	1201088450	E16A06016M010	1m

No.	Part No.	Engineering No.	Cable Length
71	1201088451	E16A06016M020	2m
72	1201088452	E16A06016M030	3m
73	1201088453	E16A06016M040	4m
74	1201088454	E16A06016M050	5m
75	1201088455	E16A06016M060	6m
76	1201088456	E16A06016M080	8m
77	1201088457	E16A06016M090	9m
78	1201088458	E16A06016M100	10m
79	1201088459	E16A06016M120	12m
80	1201088460	E16A06016M150	15m
81	1201088461	E16A06016M200	20m
82	1201088462	E16A06016M250	25m
83	1201088463	E16A06016M300	30m
84	1201088464	E16A06016M350	35m
85	1201088465	E16A06016M400	40m
86	1201088466	E16A06016M450	45m
87	1201088467	E16A06016M500	50m
88	1201088468	E16A06016M550	55m
89	1201088469	E16A06016M600	60m
90	1201088470	E16A06016M650	65m
91	1201088471	E16A06016M700	70m
92	1201088472	E16A06016M750	75m
93	1201088473	E16A06016M800	80m
94	1201088526	E16A06016M850	85m
95	1201088527	E16A06016M900	90m
96	1201088533	E16A06016M070	7m
97	1201088534	E16A06016M140	14m
98	1201088537	E16A06012M080H	8m
99			
100			
101			
102			
103			
104			
105			

SYMBOLS  = 0  = 0  = 0  = 0  = 0  = 0  = 0	THIS DRAWING CONTAINS INFORMATION THAT IS PROPRIETARY TO MOLEX ELECTRONIC TECHNOLOGIES, LLC AND SHOULD NOT BE USED WITHOUT WRITTEN PERMISSION DIMENSION UNITS: mm SCALE: 1:1		CURRENT REV DESC: CORRECTION TO OLD RJ45 DESIGN		 CSE M12 RJ45 4P DC MA STR MA STR XM			
	GENERAL TOLERANCES (UNLESS SPECIFIED) ANGULAR TOL ± 1.0°		EC NO: 639128 DRWN: RSCHEBER 2020/05/20 CHK'D: RSILLER 2020/06/08 APPR: RSILLER 2020/06/08				PRODUCT CUSTOMER DRAWING	
	4 PLACES ± 3 PLACES ± 2 PLACES ± 0.05 1 PLACE ± 0.1 0 PLACES ± 0.2		INITIAL REVISION: DRWN: JMARSZALEK 2015/07/07 APPR: RSILLER 2020/05/12		DOCUMENT NUMBER	DOC TYPE	DOC PART	REVISION
	DRAFT WHERE APPLICABLE MUST REMAIN WITHIN DIMENSIONS		THIRD ANGLE PROJECTION	DRAWING	SERIES	MATERIAL NUMBER	CUSTOMER	SHEET NUMBER

PART NO.	ENGINEERING NO.	FINISHED LENGTH
1201080574	E16A06017M005	0.5M [19.7"]
1201080575	E16A06017M010	1.0M [3'3"]
1201080661	E16A06017M100	10.0M [32'10"]

CABLE LENGTH TOLERANCES

>.3M [1FT]: +19mm-0 [+0.75in-0]

.3 - .9M [1 - 3FT]: +44.5mm-0 [+1.75in-0]

.9 - 1.8M [3 - 6FT]: +55.6mm-0 [+2.19in-0]

1.8 - 3.7M [6 - 12FT]: +88.9mm-0 [+3.50in-0]

3.7 - 7.3M [12 - 24FT]: +165.1mm-0 [+6.50in-0]

7.3-14.6M [24 - 48FT]: +317.5mm-0 [+12.50in-0]

14.6 - 30.5M [48-100FT]: +622.3mm-0 [+24.50in-0]

OVER 30M [100FT] +2% OF FINISHED LENGTH

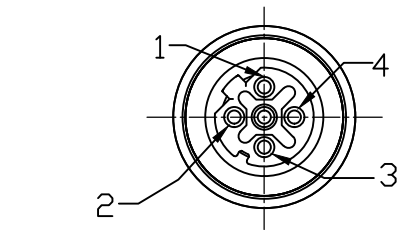

FACE VIEW - MALE M12

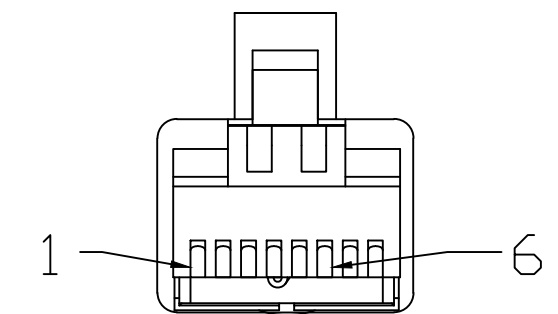
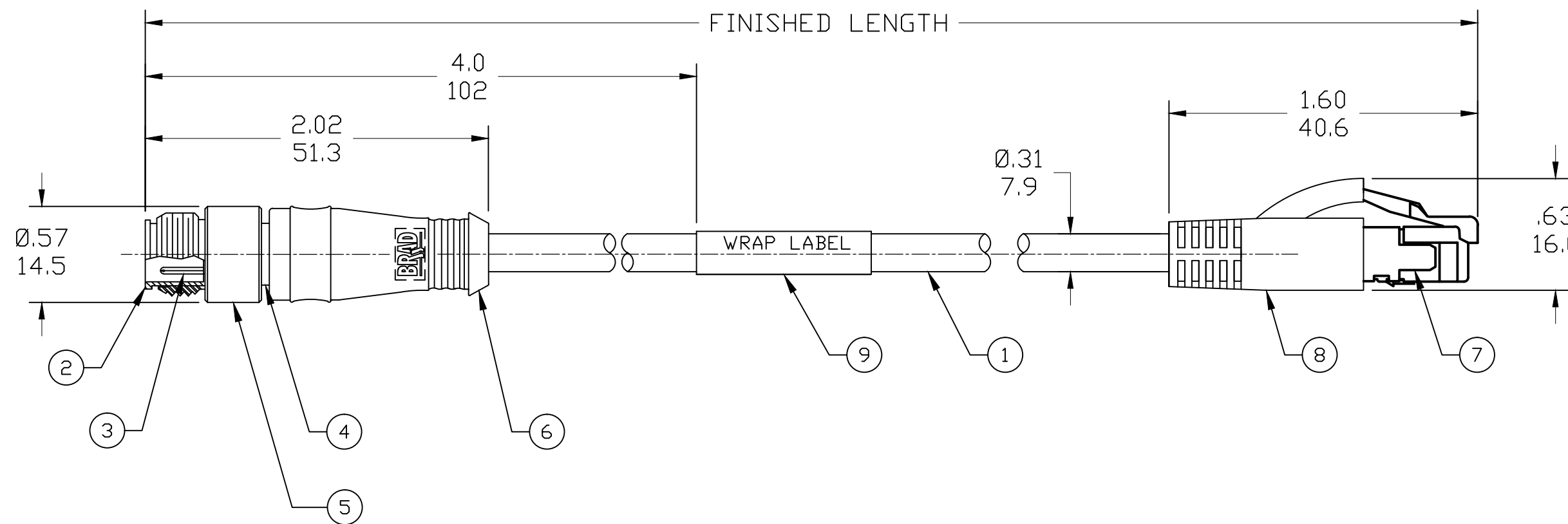

FACE VIEW - MALE RJ45
SCALE: 2X

- NOTES:**
- MATERIAL: AS NOTED
 - FINISH: AS NOTED
 - ELECTRICAL:
VOLTAGE: 125V
CURRENT: 1.5A
 - TEMP RATING: -20° TO +75°C
 - PROTECTION: IP67 (WHEN MATED)
 - COUPLING THREAD: M12 X 1
 - UL CERTIFIED FILE: E200650
 - ALL DIMS ARE FOR REFERENCE UNLESS NOTED OTHERWISE

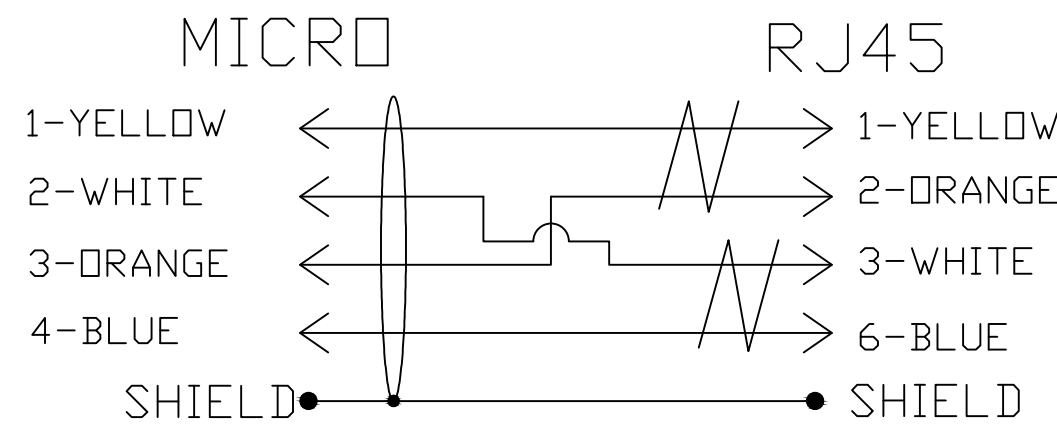

WIRING DIAGRAM

PART NUMBER LEGEND

E16A06017M005

FINISHED LENGTH:
M005= 0.5 METER
M010= 1 METER
M100= 10 METER

REF. THIS DRAWING SUPERSEDES CO-CREATE DRAWING SD-120108-091 REV-B

ITEM	DESCRIPTION	MATERIAL	FINISH
9	WRAP LABEL	VINYL	BLACK/YELLOW
8	RJ-45 BOOT	PVC	BLACK
7	RJ-45 PLUG	POLYCARBONATE	CLEAR
6	OVERMOLD	PBT	GRAY
5	COUPLING NUT	BRASS	NICKEL PLATED
4	SHIELD HOUSING	BRASS	NICKEL PLATED
3	CONTACT PIN	COPPER ALLOY	GOLD PLATED
2	MALE INSERT, D-CODE	PUR	BLACK
1	CABLE, 2 PAIR, 22AWG, SHLD	TPE JACKET	GREEN

REVISED PER LATEST STD EC NO: IPG2019-0171 DRWN: RSTONE 2018/10/15 CHKD: C CHRAST 2018/10/22 APPR: BWOODMAN	QUALITY SYMBOL ▽=0 ▽=0	GENERAL TOLERANCES (UNLESS SPECIFIED) 4 PLACES ±--- 3 PLACES ±--- 2 PLACES ±--- 1 PLACE ±---	DIMENSION STYLE IN/MM	SCALE NTS	DESIGN UNITS INCH	THIRD ANGLE PROJECTION
	ANGULAR ±---°	DRAFT WHERE APPLICABLE MUST REMAIN WITHIN DIMENSIONS	DRAWN BY: RSTONE DATE: 2018/10/15	CHECKED BY: C CHRAST DATE:	APPROVED BY:	TITLE M12 TO RJ45 CORDSET 4P MALE M12/RJ45 ST PROFI-NET
	MATERIAL NO. SEE P/N CHART	DOCUMENT NO. SD-120108-092	SHEET NO. 1 OF 1	MOLEX INCORPORATED		
	THIS DRAWING CONTAINS INFORMATION THAT IS PROPRIETARY TO MOLEX INCORPORATED AND SHOULD NOT BE USED WITHOUT WRITTEN PERMISSION					