

DESCRIPTION: HIGH DENSITY - MACHINED CONTACTS - RIGHT ANGLE

MATERIALS AND FINISH:

SHELL: STEEL MATERIAL, NICKEL FINISH
 INSULATOR: (SEE CHART) =260°C, UL 94V-0 RATED, BLACK
 CONTACT MATERIAL: BRASS
 CONTACT FINISH: SELECTIVE GOLD FINISHED

ELECTRICAL:

CONTACT CURRENT RATING: 5 AMPS
 CONTACT RESISTANCE: 10 mOHMS Max.
 DIELECTRIC WITHSTANDING VOLTAGE: 1,000VAC Min.
 INSULATION RESISTANCE: 5 GOHMS Min.
 TEMPERATURE RATING: -55° ~ +125° C

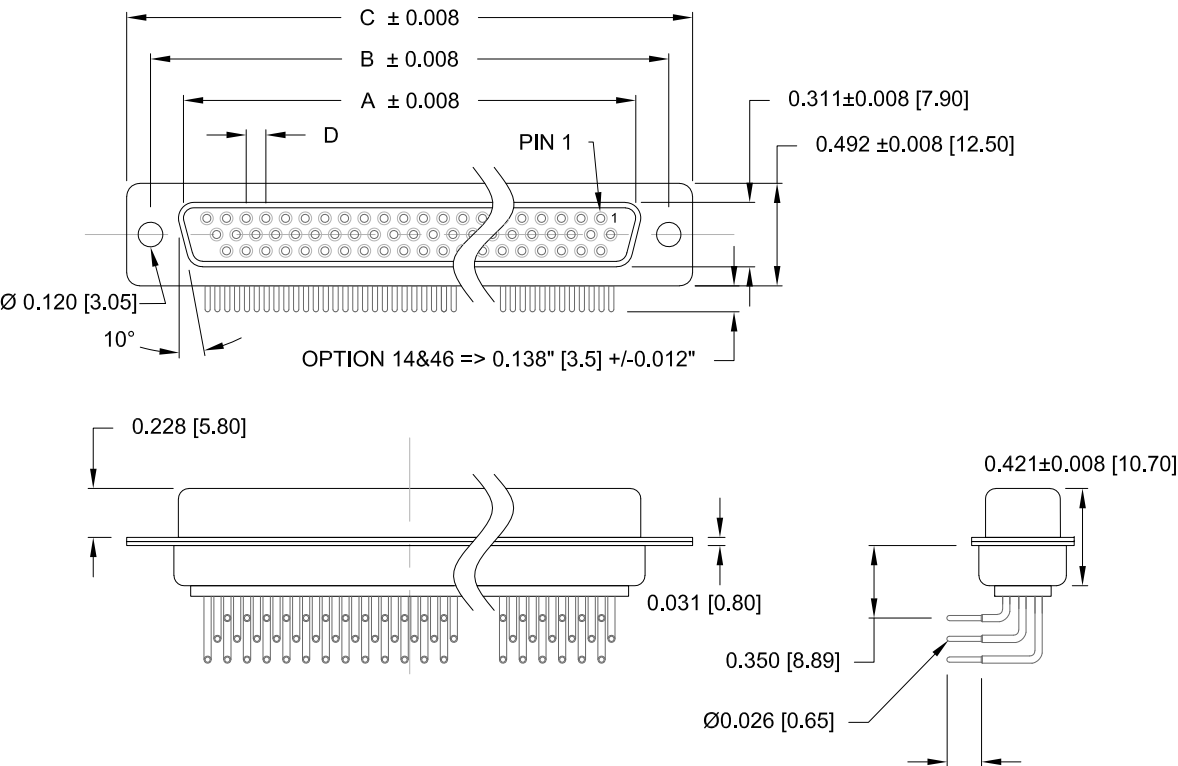

OPTION 14&46 => 0.138" [3.5] +/-0.012"

HW Option 14 & 46 => 0.138" [3.5]

181-MYY-2YYRYYY

SERIES _____
 MACHINED CONTACTS _____
 POSITIONS _____
 15 _____
 26 _____
 44 _____
 62 _____
 GENDER _____
 2 = FEMALE
 TERMINATION _____
 1 = RIGHT ANGLE
 SHELL PLATING _____
 2 = TIN
 3 = NICKEL
 RoHS COMPLIANT _____
 HARDWARE OPTIONS _____
 14 = BRACKET WITH #4-40 INSERT, BOARD LOCK AND LOCATOR PLATE
 46 = BRACKET WITH #4-40 SCREW LOCK, BOARD LOCK AND LOCATOR PLATE
 PLATING OPTIONS _____
 1 = GOLD FLASH, ENTIRE CONTACT
 2 = 30u" GOLD, ENTIRE CONTACT
 3 = 50u" GOLD, ENTIRE CONTACT

DIMENSIONS (IN.)

No. OF PINS	A	B	C	D	Insulator Material
15	0.642	0.984	1.213	0.090	PA9T
26	0.968	1.311	1.543	0.090	PA9T
44	1.512	1.852	2.089	0.090	PA9T
62	2.157	2.500	2.732	0.095	PA6T

DIMENSIONS (mm)

No. OF PINS	A	B	C	D	Insulator Material
15	16.30	25.00	30.80	2.29	PA9T
26	24.60	33.30	39.20	2.29	PA9T
44	38.40	47.05	53.05	2.29	PA9T
62	54.80	63.50	69.40	2.41	PA6T

UNITS = INCHES [mm]

DO NOT SCALE FROM DRAWING



THESE DRAWINGS AND SPECIFICATIONS ARE THE PROPERTY OF NorComp AND SHALL NOT BE REPRODUCED, COPIED OR USED AS THE BASIS FOR THE MANUFACTURE OF SALE OF APPARATUS WITHOUT WRITTEN PERMISSION.

DRAWN:	C. SMITH	DATE:	03-19-07
--------	----------	-------	----------

NorComp

SCALE:	NTS	SHEET	OF	REV	23
		1	4		
DWG NO.	181-MYY-2YYRYYY				

RoHS COMPLIANT

DESCRIPTION: HIGH DENSITY - MACHINED CONTACTS - RIGHT ANGLE

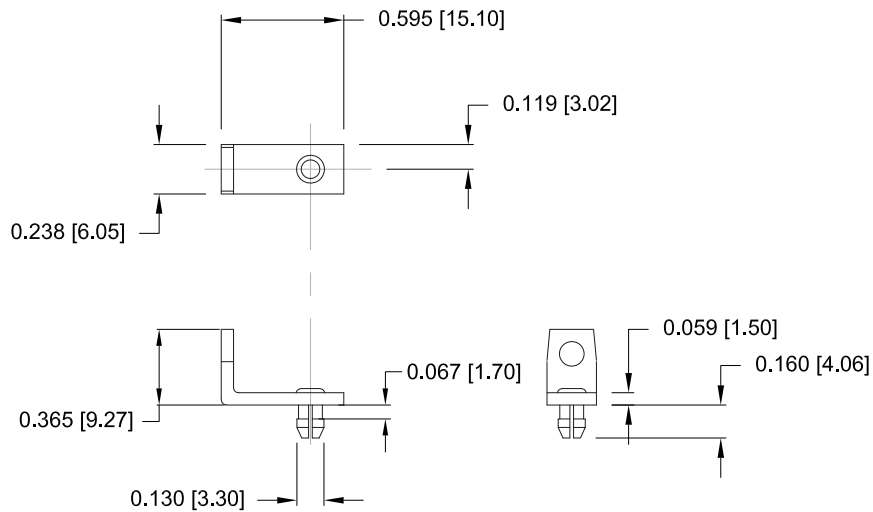

**MOUNTING BRACKET
WITH BOARD LOCK**
HARDWARE OPTIONS 14 & 46

MATERIAL: COLD ROLLED STEEL
PLATING: CLEAR ZINC

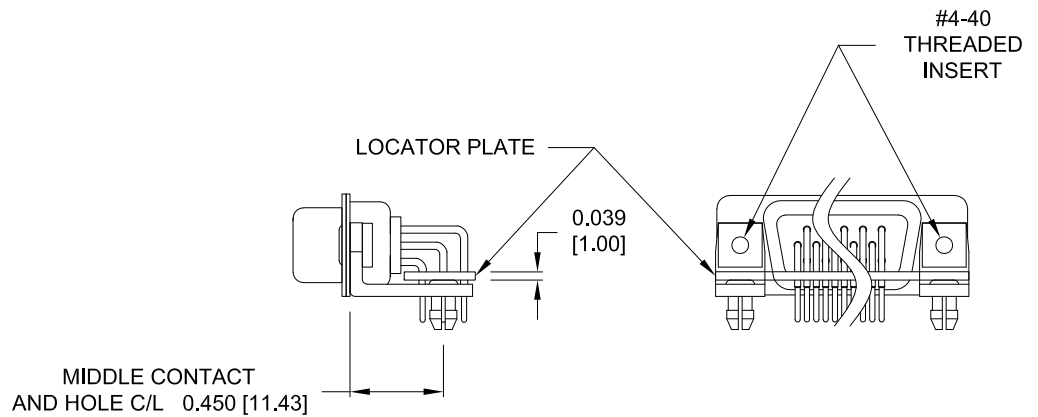

HARDWARE OPTIONS 14

**BRACKETS MOUNTED ON CONNECTOR
WITH LOCATOR PLATE**

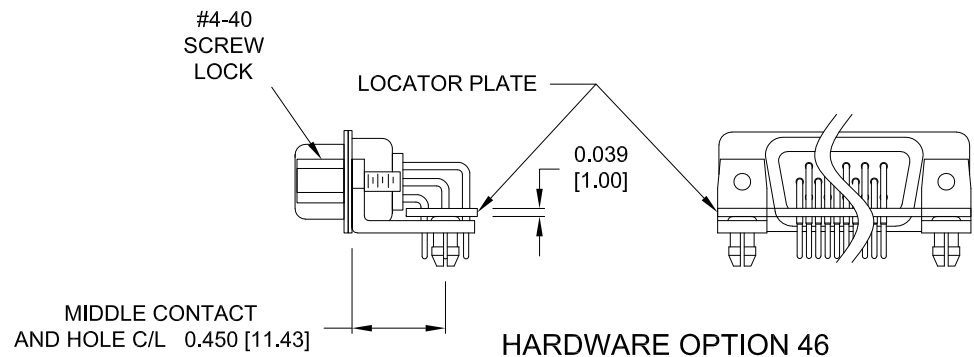

HARDWARE OPTION 46

UNITS = INCHES [mm]

DO NOT SCALE FROM DRAWING

	THESE DRAWINGS AND SPECIFICATIONS ARE THE PROPERTY OF NorComp AND SHALL NOT BE REPRODUCED, COPIED OR USED AS THE BASIS FOR THE MANUFACTURE OF SALE OF APPARATUS WITHOUT WRITTEN PERMISSION.		DRAWN: C. SMITH	DATE: 03-19-07
	NorComp		SCALE: NTS	SHEET OF 2 OF 4
DWG NO. 181-MYY-2YYRYYY				

DESCRIPTION: HIGH DENSITY LOCATOR PLATES - 15, 26, 44, 62 & 78

MATERIAL: INSULATION PAPER
0.039" THICK

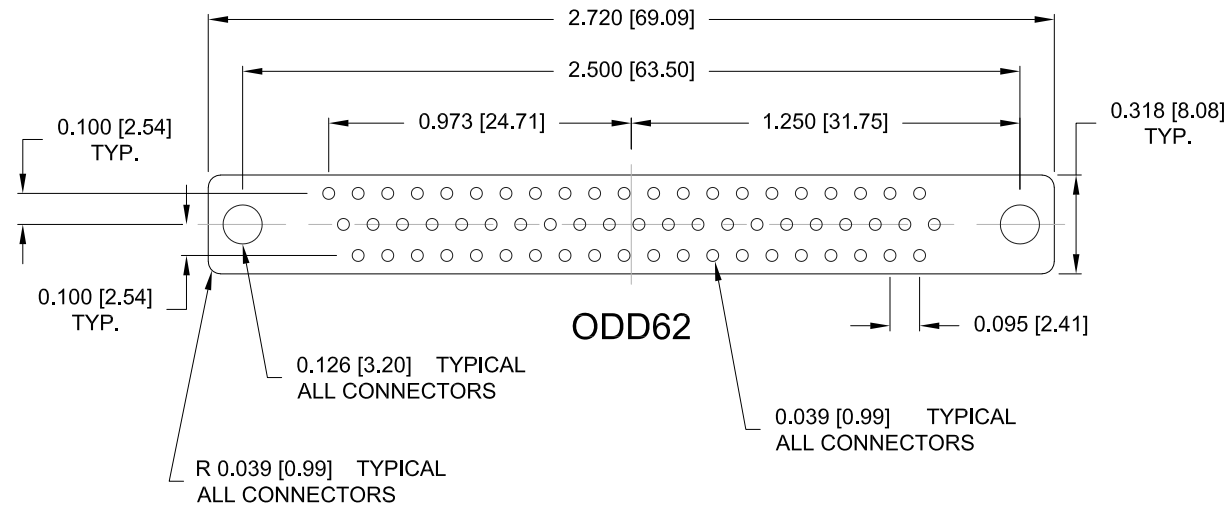
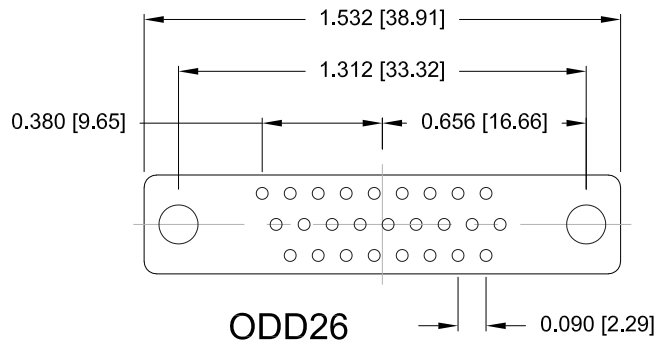
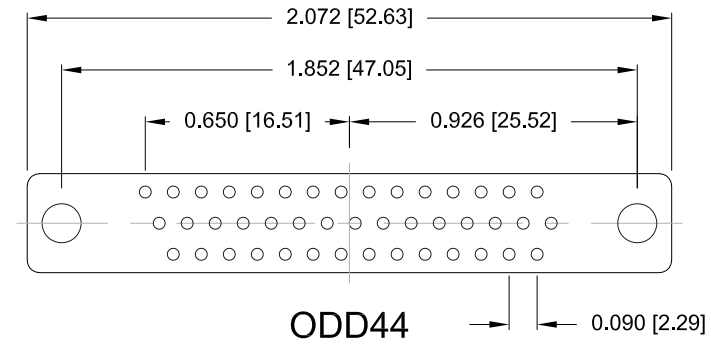
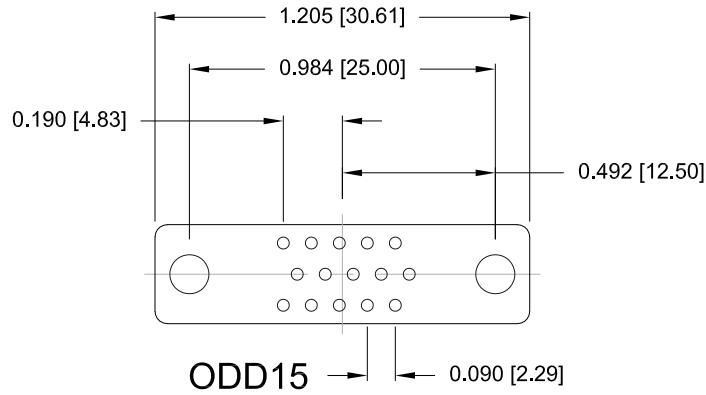

UNITS = INCHES [mm]

DO NOT SCALE FROM DRAWING



THESE DRAWINGS AND SPECIFICATIONS ARE THE PROPERTY OF NorComp AND SHALL NOT BE REPRODUCED, COPIED OR USED AS THE BASIS FOR THE MANUFACTURE OF SALE OF APPARATUS WITHOUT WRITTEN PERMISSION.

DRAWN: C. SMITH DATE: 03-19-07

NorComp

SCALE: NTS SHEET 3 OF 4 REV 23

DWG NO. 181-MYY-2YYRYYY

RoHS COMPLIANT

DESCRIPTION: HIGH DENSITY - MACHINED CONTACTS - RIGHT ANGLE

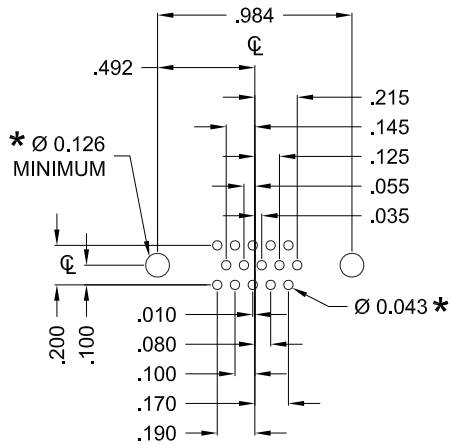

15 POSITION

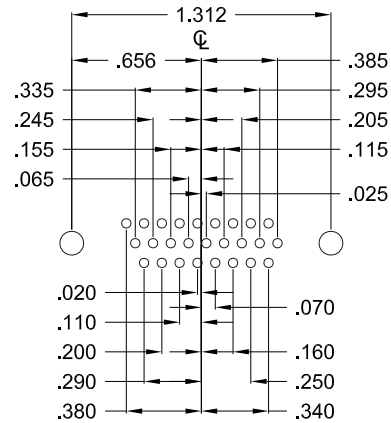

26 POSITION

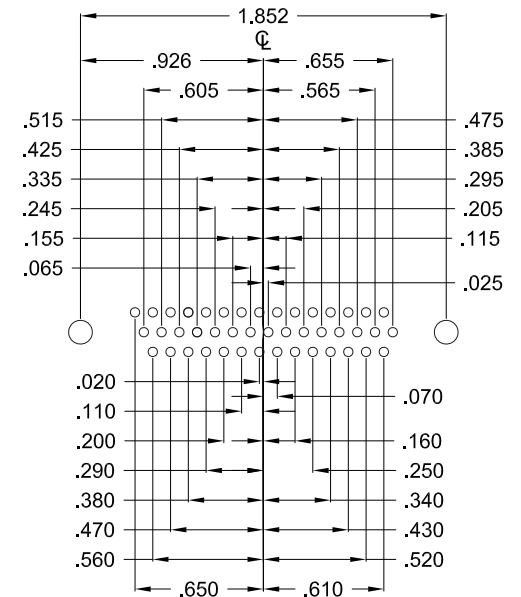

44 POSITION

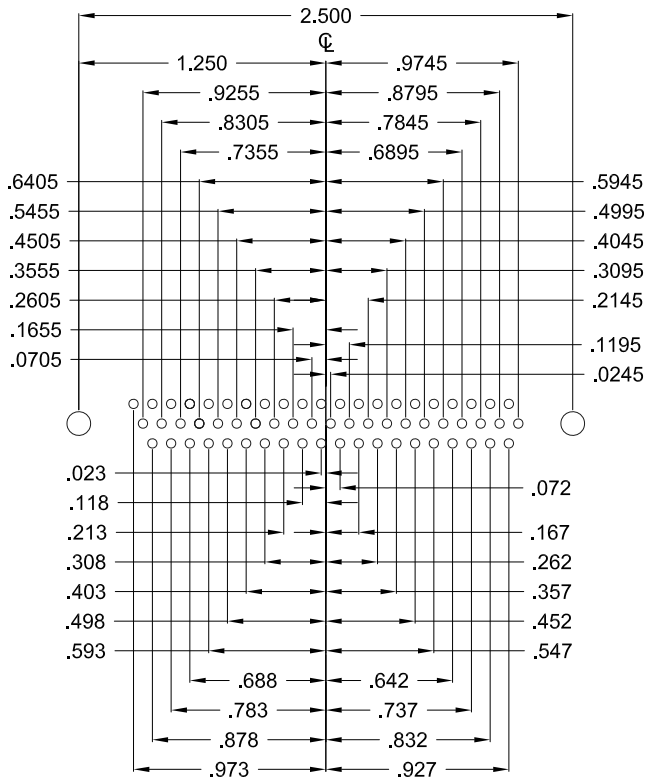

62 POSITION

HOLE PATTERN SHOWN ARE FOR FEMALE

UNITS = inch

* TYP. SUGGESTED SIZE MAY NOT BE SUITABLE FOR ALL APPLICATIONS

DO NOT SCALE FROM DRAWING

	THESE DRAWINGS AND SPECIFICATIONS ARE THE PROPERTY OF NorComp AND SHALL NOT BE REPRODUCED, COPIED OR USED AS THE BASIS FOR THE MANUFACTURE OF SALE OF APPARATUS WITHOUT WRITTEN PERMISSION.		DRAWN: C. SMITH	DATE: 03-19-07
	<h1>NorComp</h1>		SCALE: NTS	SHEET OF 4 4
DWG NO.			181-MYY-2YYRYYY	