

# Product Document



## User Guide

UG001009

# AS7343

## 14-Channel Multi-Spectral Sensor For Spectral and Color Measurement

### Manual Evaluation Kit

v2-00 • 2022-Sep-05

---

# Content Guide

<b>1</b>	<b>Introduction .....</b>	<b>3</b>	6.3	Hot Keys .....	26
1.1	Kit Content.....	3	6.4	Sensor Board Test.....	28
1.2	Alternative Sensor Board Interfaces and Housings.....	4	6.5	Offset Compensation.....	29
1.3	Ordering Information .....	7	6.6	Operation Mode.....	30
<b>2</b>	<b>Getting Started .....</b>	<b>8</b>	6.7	Main Tab.....	31
2.1	System Setup .....	8	6.8	ALS Light Detection.....	37
2.2	Software Installation .....	9	6.9	Reflection Mode.....	43
<b>3</b>	<b>Hardware Description .....</b>	<b>11</b>	6.10	Window Log.....	46
3.1	Hardware Architecture.....	11	6.11	Flicker Log.....	46
3.2	Power Supply .....	12	6.12	Detection Log .....	46
3.3	Onboard Example LEDs.....	12	6.13	Flicker Detection.....	46
3.4	Connector Pinout Description.....	13	6.14	Register Mapping .....	50
<b>4</b>	<b>Optical Diffuser.....</b>	<b>15</b>	6.15	Tracer .....	51
<b>5</b>	<b>Correction and Calibration .....</b>	<b>18</b>	<b>7</b>	<b>Error Message List .....</b>	<b>54</b>
<b>6</b>	<b>Software .....</b>	<b>19</b>	<b>8</b>	<b>Additional Documents.....</b>	<b>57</b>
6.1	Initialization Files .....	19	<b>9</b>	<b>Revision Information .....</b>	<b>58</b>
6.2	EVM Graphical User Interface.....	25	<b>10</b>	<b>Legal Information.....</b>	<b>59</b>

# 1 Introduction

This AS7343 Evaluation Kit (EVK) is a platform to evaluate the spectral sensor applications and demonstrate different use cases. It realizes basic functions to get the sensor's ADC counts based on alternative setups and includes special functions - to demonstrate application-specific tasks (ALS Ambient Light Sensing, Reflection Mode, Flicker Detection and Spectral, and Color Mask Compare). Perhaps, these functions need a hardware adaptation (e.g. LED on board for reflection) or an additional optional mechanical interface, which must be ordered separately. In general, there are two standard evaluation kits available, which are different in use case and optical adapters.

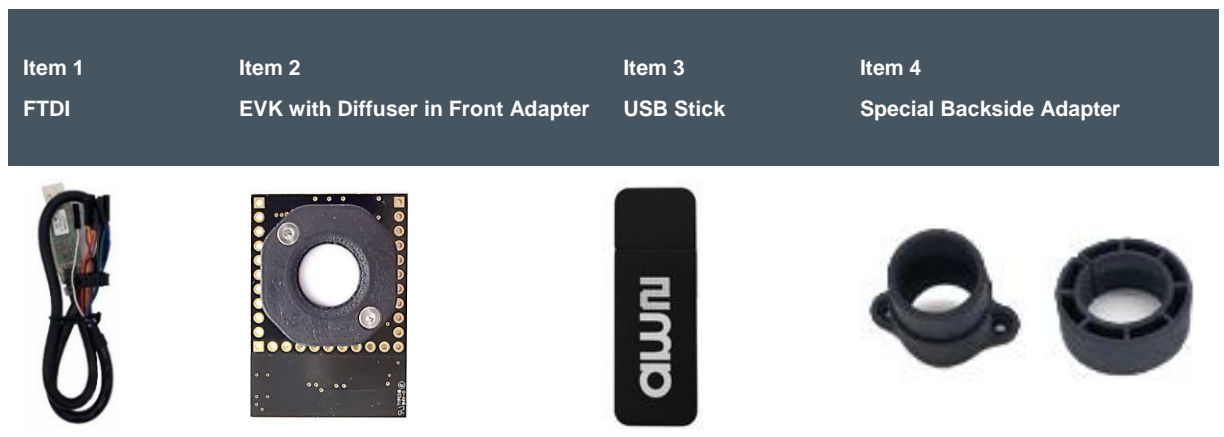
- The standard ALS kit is for measuring contactless ambient lighting or light sources - includes the hardware version without LEDs on board, but with a diffuser in front of the sensor with a maximum field of view. It represents the standard kit (see Figure 1) for light measurement /detection or liquid measurements in transmission.
- The extended kit, reflection mode, is for contact measurement of colored surfaces (see Figure 2) and consists of the sensor hardware, but with a pre-assembled LED (broad band white LED) and a special adapter in front of the sensor with 0° (Sensor) /45° (LEDs) geometry.

This user manual describes the features and functions for both variants, all supported sensor types, and sensor hardware connected to a PC with an I<sup>2</sup>C-FTDI Interface. The software and driver are limited to a PC with MS Window. Other interfaces for the sensor boards are in preparation. Ask our support team for more details.

## 1.1 Kit Content

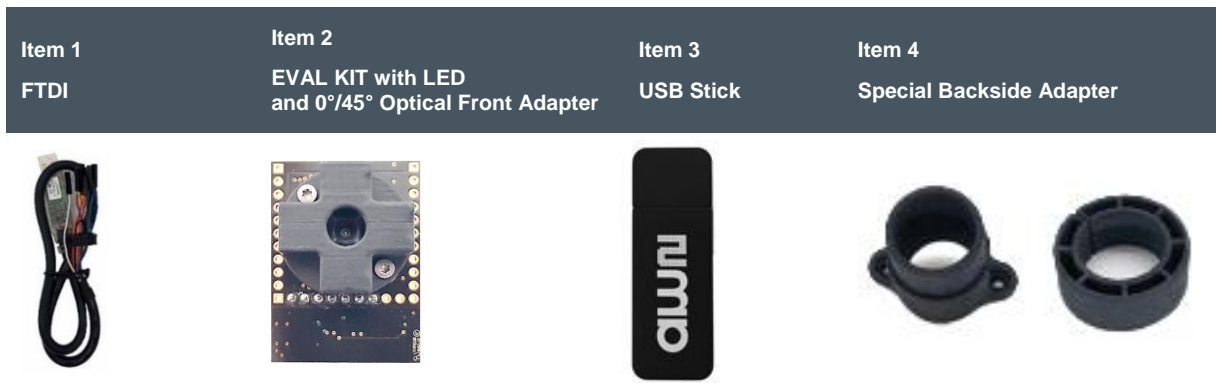
The Evaluation Kit contains the following items shown in Figure 1.

**Figure 1**  
Kit Content of EVK Variant ALS



Item No.	Item	Comment
1	FTDI - USB Cable	USB – I <sup>2</sup> C Cable with 10-pole IDC Connector, 5 V
2	AS7343 EVK ALS	Evaluation Kit with pre-assembled Front Adapter and Diffuser
3	USB Data Stick	Documents, software, firmware and drivers.
4	Special Backside Adapter EVAL Linos 16 EVAL Linos 16-25	3D-Printing part, used to adapt the 16 mm holder into: <ul style="list-style-type: none"> <li>• 16 mm Linos-Nano-Bank (above)</li> <li>• 25 mm Linos-Nano-Bank (below)</li> </ul>

Figure 2 :  
Kit Content of EVK Variant Reflection



Item No.	Item	Comment
1	FTDI - USB Cable	USB – I <sup>2</sup> C Cable with 10 pole IDC Connector, 5 V
2	AS7343 EVK Reflection	Evaluation Kit with pre-assembled LED and 0°/45° Front Adapter (without diffuser <sup>(1)</sup> ).
3	USB Data Stick	Documents, software, firmware and drivers.
4	Special Backside Adapter EVAL Linos 16 EVAL Linos 16-25	3D-Printing part, used to adapt the 16 mm holder into: <ul style="list-style-type: none"> <li>• 16 mm Linos-Nano-Bank (above)</li> <li>• 25 mm Linos-Nano-Bank (below)</li> </ul>

(1) Customers should add a diffuser in front of the sensor in case of a none diffusible application

## 1.2 Alternative Sensor Board Interfaces and Housings

The current standard delivery for the ALS and reflection variants, is the sensor board with an FTDI as an I<sup>2</sup>C to USB conversion, and a connection via Com-Interface on the PC and Windows. In addition, other electronic interfaces are possible, which are supported by the test software.



**Information**

Please note that when using these, your drivers may have to be installed. Further driver details are listed in chapter 1.2.1.

**1.2.1 Unicom Interface Board**

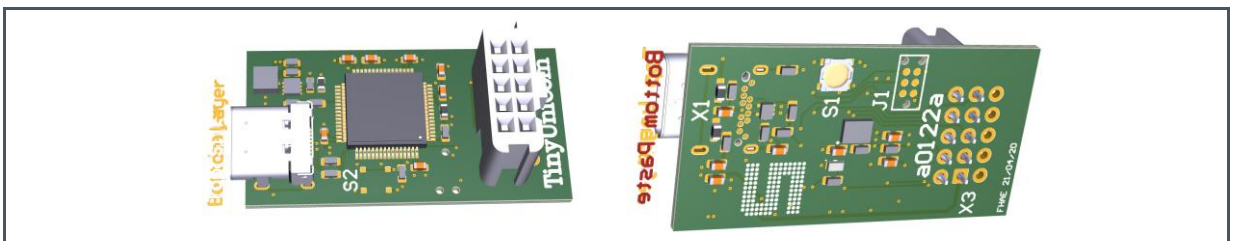
While the FTDI interface is a pure I<sup>2</sup>C to USB converter and works in a time-limited manner, the Unicom is in a standard form factor. The following figures show both Unicom versions, which differ only in form factor and interface. They both run with the same firmware but have different interfaces on the contact strips and connectors. Figure 3 shows the standard version and Figure 4 shows a miniaturized version.

In general, this board is a data logger with an onboard controller. Depending on the programming, the Unicom can work as a simple converter or as a data logger. In logger mode, very high measuring speeds are possible if the software on the host side supports this. The standard GUI works under Windows and is not real-time capable. The GUI does not fully utilize the Unicom in terms of frequency. Here, the Unicom board works only as a simple converter, but with the supported software on the microcontroller. The following figures show both Unicom versions, which differ only in form factor and interface.

**Figure 3:**  
**Unicom Interface (Standard Version) with all Interfaces and Complete Size**

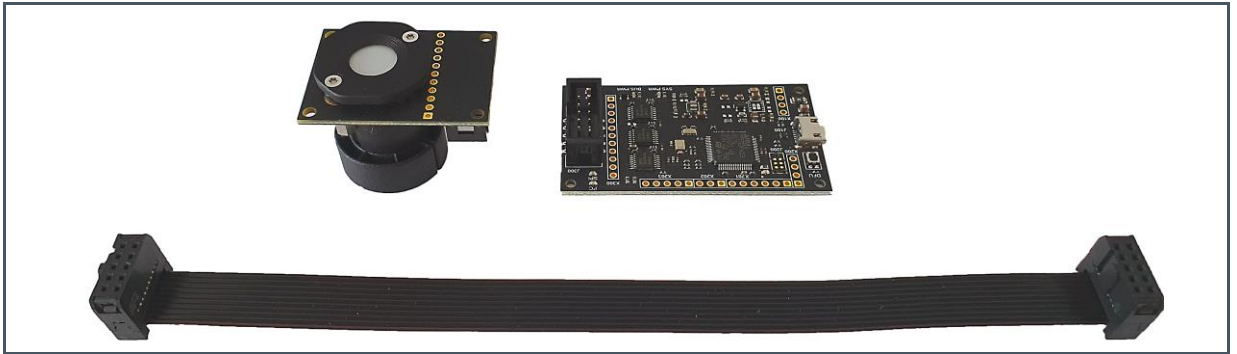


**Figure 4:**  
**Unicom Interface (Tiny Version) with Limited Interfaces in a Small Size**



Both boards also differ in the mounting of the sensor board or the mounting in a housing. The following figures show some examples where ams OSRAM can deliver the design and manufacturing data.

**Figure 5:**  
Sensor and Standard Unicom Board Connected via Ribbon Cable and USB-Interface



**Figure 6:**  
Sensor and Standard Unicom Board Connected via Ribbon Cable, USB-Interface, and an Insertable Plastic Housing



**Figure 7:**  
Sensor and Tiny Board Directly Plugged with a USB-Interface, and Plastic Housing



### 1.3 Ordering Information

Ordering Code	Description
AS7343 EVK ALS	14-Channel Spectral Sensor Evaluation Kit for ALS
AS7343 EVK REFLECTION	14-Channel Spectral Sensor Evaluation Kit for Reflection Mode



**Attention**

Please order optional parts separately.



**Information**

It is also possible to print or modify the customized adapters. See the document path of the USB stick for the 3D models.



---

## 2 Getting Started

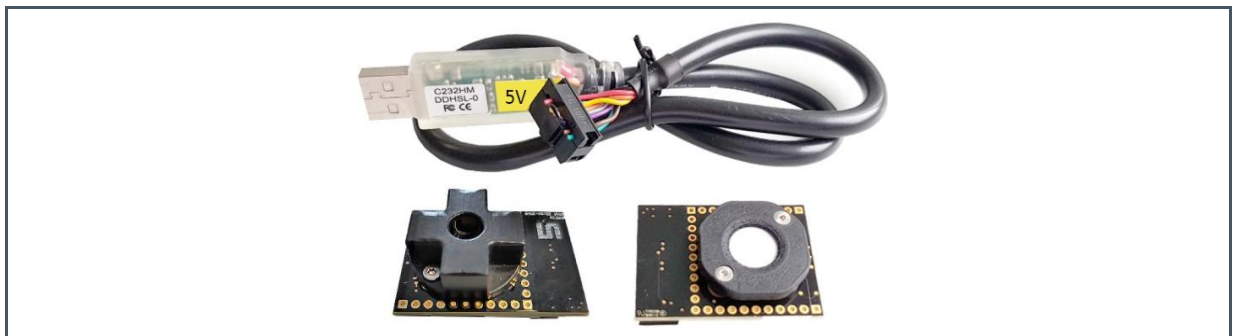
---

### 2.1 System Setup

The evaluation kit consists of the FTDI cable<sup>1</sup> (I<sup>2</sup>C to USB converter) and the sensor board with pre-mounted adapters. Adapters on the front side are necessary to meet the optical requirements of the sensor filter specification or to adapt the sensor to application-specific requirements (field of view or 0°/45° geometry). Adapters on the rear side are used to mount the EVK in mechanical test systems.

The FTDI<sup>2</sup>-adapter, with a USB interface and a COM-Port driver (or alternative solutions), converts the sensor signals into the PC GUI. Figure 8 shows the FTDI cable (above), the sensor board for Reflection Mode (below left), and the standard version e.g. for ALS Light Detection (right).

**Figure 8:**  
Evaluation Kit with the Sensor Hardware, Optical Adapters (Front), and FTDI Adapter<sup>(1)</sup>



(1) Accessories may differ from the picture.

---

<sup>1</sup> As an alternative use the Unicom board as an interface between the sensor board and PC. The GUI is compatible to work with both.

<sup>2</sup> 5V FTDI standard; 3.3V FTDI possible in former board designs.

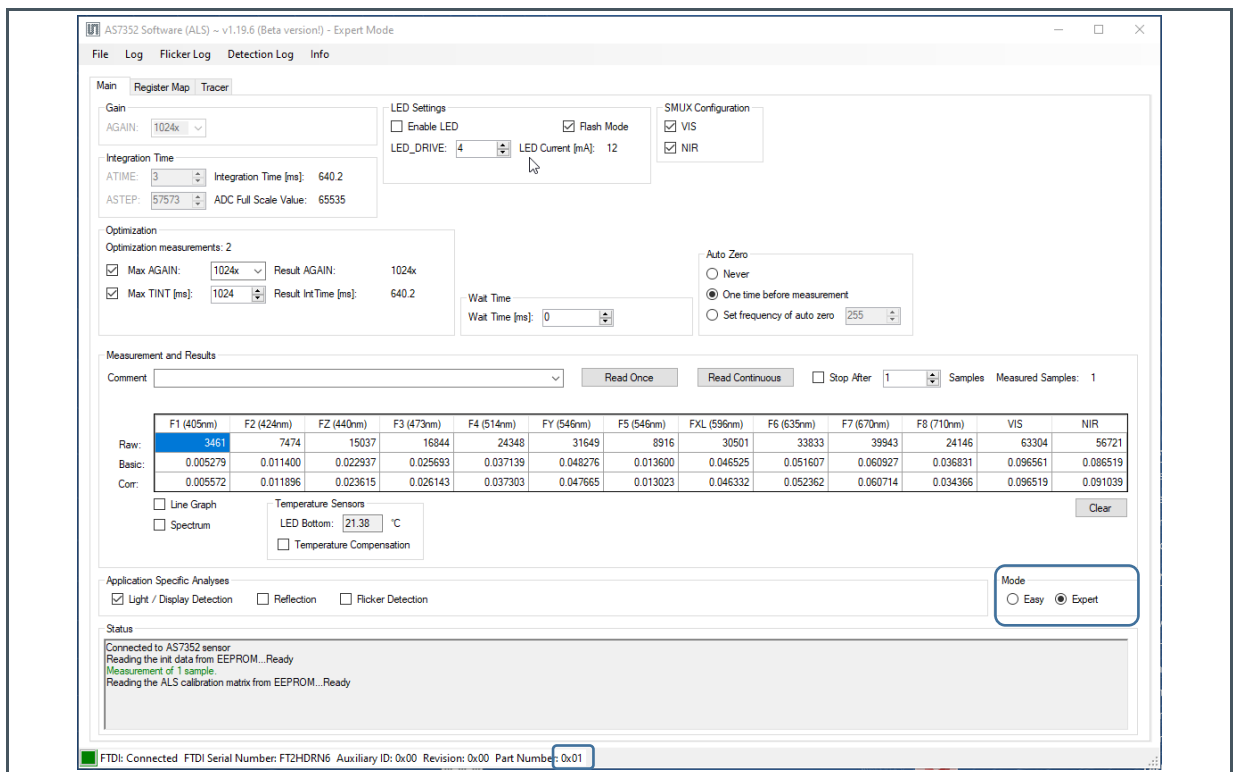
To get started with the evaluation kit, perform the following steps:

1. Select the correct evaluation KIT for your application.
2. Install the GUI (MSI) and all the drivers from the USB stick (please refer to chapter 2.2).
3. Plug in the FTDI (or Unicom with) cable into the socket of the sensor board. Then, connect the kit to the PC.
4. If there is an issue during the installation process, please see the details in chapter 2.2.

## 2.2 Software Installation

The GUI is compatible with Window 10 - where .NET Framework 4.5.2 or a later version is pre-installed. Before connecting the FTDI adapter to the computer, the specified FTDI driver<sup>3</sup> must be installed. Start the 'CDM21216\_Setup.exe' and follow the step-by-step instructions. Then connect the EVK to the computer via the FTDI adapter.

**Figure 9:**  
**Typical<sup>(1)</sup> Main Tab in Expert Mode and Status Bar with AS7343 Connected**



- (1) The software is used for different test systems based on the AS7343. The GUI may consider this with additional information, changed functions, or other release. Filter names may vary in the interest of progress.

<sup>3</sup> Newer Windows 10 installations do not need an extra FTDI driver installation because it is useable with the standard Windows drivers. On the contrary, sometimes an old FTDI driver interferes with the system and has to be uninstalled with a special software for using the Windows driver - <https://ftdichip.com/utilities/#cdm-uninstaller>.

Start the software installation from the USB stick '\*.msi' and then start the GUI directly from the program directory: 'C:\Program Files (x86)\ams-OSRAMAS7343 Demo'. Afterward, it should show the Main Tab and the successful connection to the EVK in the status bar and footer line (see Figure 9).

The GUI needs some initialization files, which will be installed during the setup in the user directory 'C:\Users\user\AppData\Roaming\ams-OSRAMAS7343 Demo' (see Figure 10).

During installation, the standard initialization files are generated in the folder 'UserData' (C:\Users\user\AppData\Roaming\ams-OSRAMAS7343 Demo). The GUI continuously checks if these standard files still exist in this area. If not, the GUI will install the missing files again.










Consider saving the previously used initialization files if needed. For more details, see chapter 6.1.



**Attention**

A de-installation process will also delete the standard initialization files. Therefore, create a backup or copy of such files in case you want to use them after de-installation, or use alternative file names for the initialization files.

**Figure 10:**  
Typical User Directory with the ALS Initialization Files

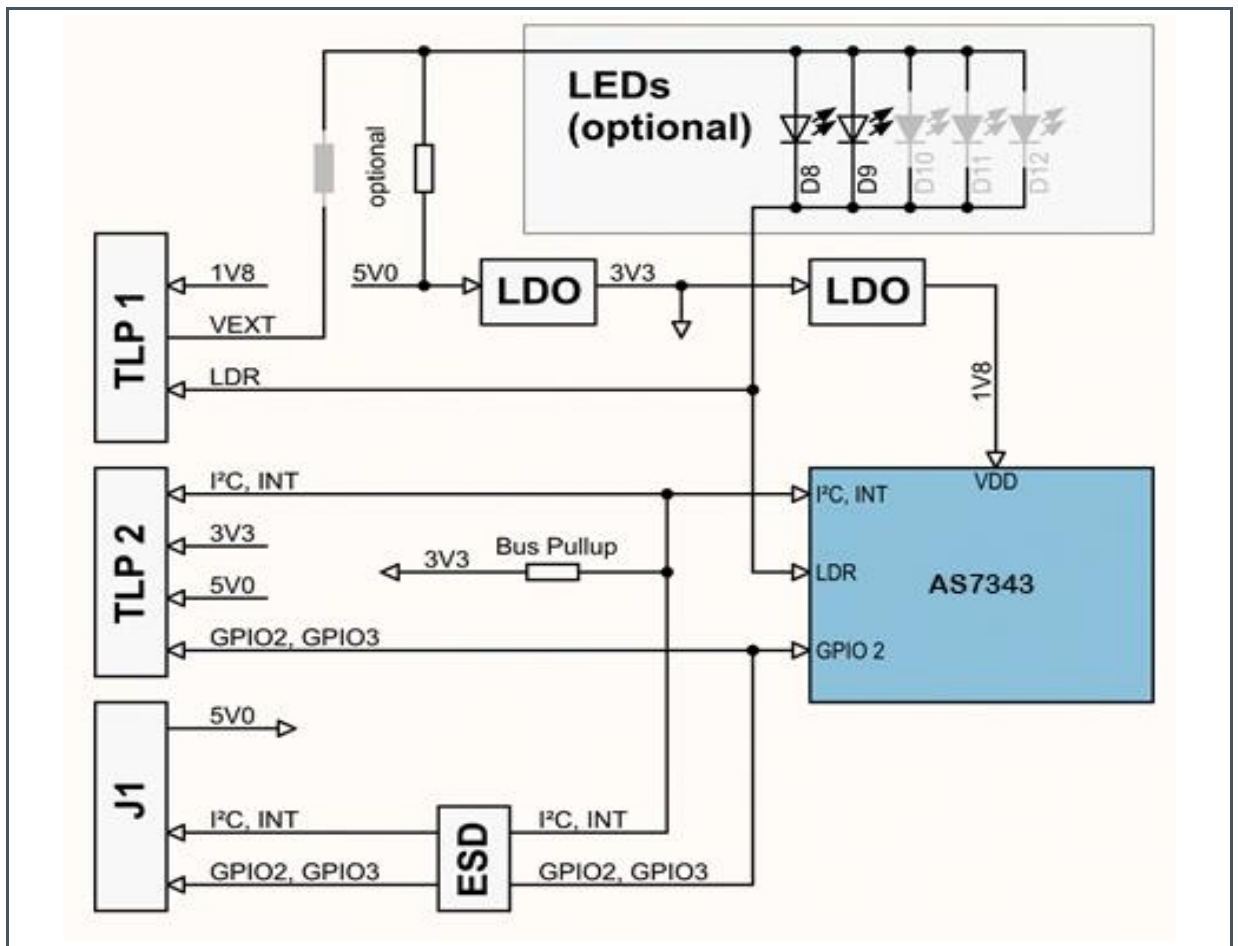
	AS7343_EvalSw.config	18.05.2022 11:25	CONFIG File	2 KB
	AS7343_Script.txt	28.03.2022 10:50	Text Document	3 KB
	CM_L1_v1_0_0#spectral.csv	28.03.2022 10:50	Microsoft Excel C...	111 KB
	gain test.txt	28.03.2022 10:50	Text Document	1 KB
	init_file.txt	28.03.2022 10:50	Text Document	5 KB
	Mask_L_v1_0_0.csv	28.03.2022 10:50	Microsoft Excel C...	132 KB
	Readme_AS7343.txt	28.03.2022 10:50	Text Document	15 KB
	TC_v1_0_0.csv	28.03.2022 10:50	Microsoft Excel C...	13 KB
	tint test.txt	28.03.2022 10:50	Text Document	1 KB

# 3 Hardware Description

## 3.1 Hardware Architecture

The AS7343 Evaluation Kit includes an LDO to provide the 1.8 V supply voltage for the sensor chip, ESD protection diodes for the I<sup>2</sup>C bus and GPIO lines, and a placeholder for optional LEDs. The LEDs<sup>4</sup> can be powered - either from the FTDI adapter or externally via the connector TLP1. This is achieved with a 10-pole IDC socket for connecting the FTDI adapter cable (J1) and 1/10 inch rows of holes for mounting on a 1/10 inch hole grid plate or by directly contacting signals (TLP1 to TLP2).

Figure 11 :  
AS7343 Board Block Diagram



<sup>4</sup> Must be soldered by the customer or use AS7343/AS7343 EVK Reflection. The function of the LED current, light intensity, and/or maximal driver current depends on the used LEDs and the connected power supply. Check the LED datasheet before using this LED setting. An LED current can destroy the LEDs if it is too high.

## 3.2 Power Supply

In general, the FTDI converter produces the 5 V power supply for the sensor board. The converter is part of the original package of the EVK. Customers can use onboard alternative pre-designed power supplies. For more details, see Figure 14.



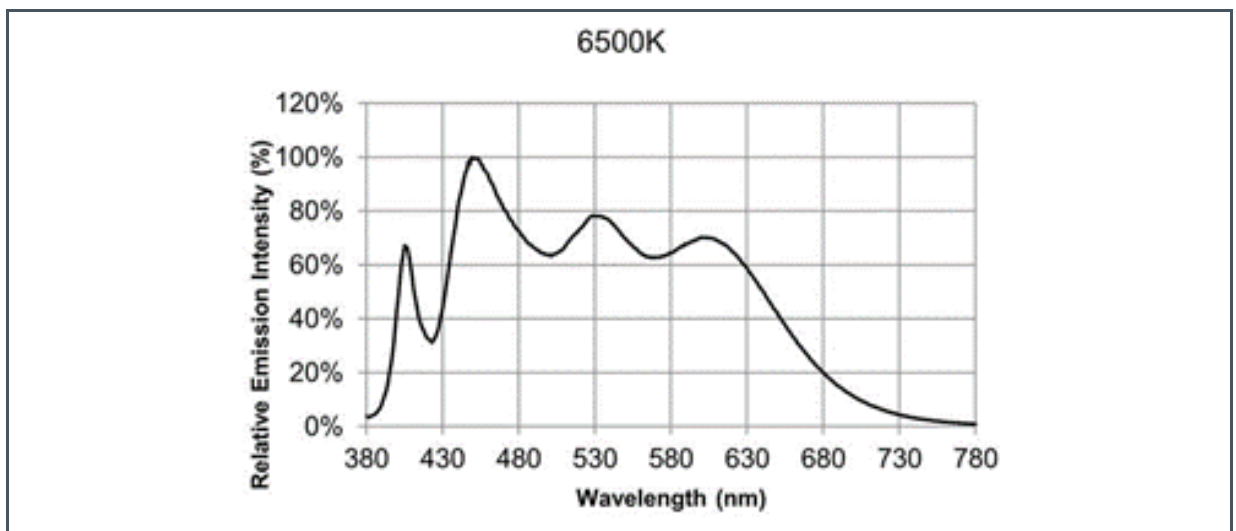
### Information

Make sure to use the original adapters and converters before connecting the hardware to the USB.

## 3.3 Onboard Example LEDs

The LEDs on this Evaluation Board are broad banded white light LEDs. The typical spectral distribution is shown in Figure 12.

**Figure 12:**  
Typical Spectral Distribution of an LED



If the power supply of the Evaluation Board is 5 V, it will not be possible, in connection with the series resistor, to get a current bigger than 200 mA through both LEDs and 100 mA for one LED. This limit is given by a 5 V power supply and both 10 Ohm series resistors.

It is possible to connect the Evaluation Board to a bigger power consumption voltage. Pin1 on TLP1 is for external LED voltage distribution. (Pin2 TLP1 is GND). R11 is to be disassembled and fitted as R13.

### 3.4 Connector Pinout Description

Figure 13:  
Pinout Connector Description

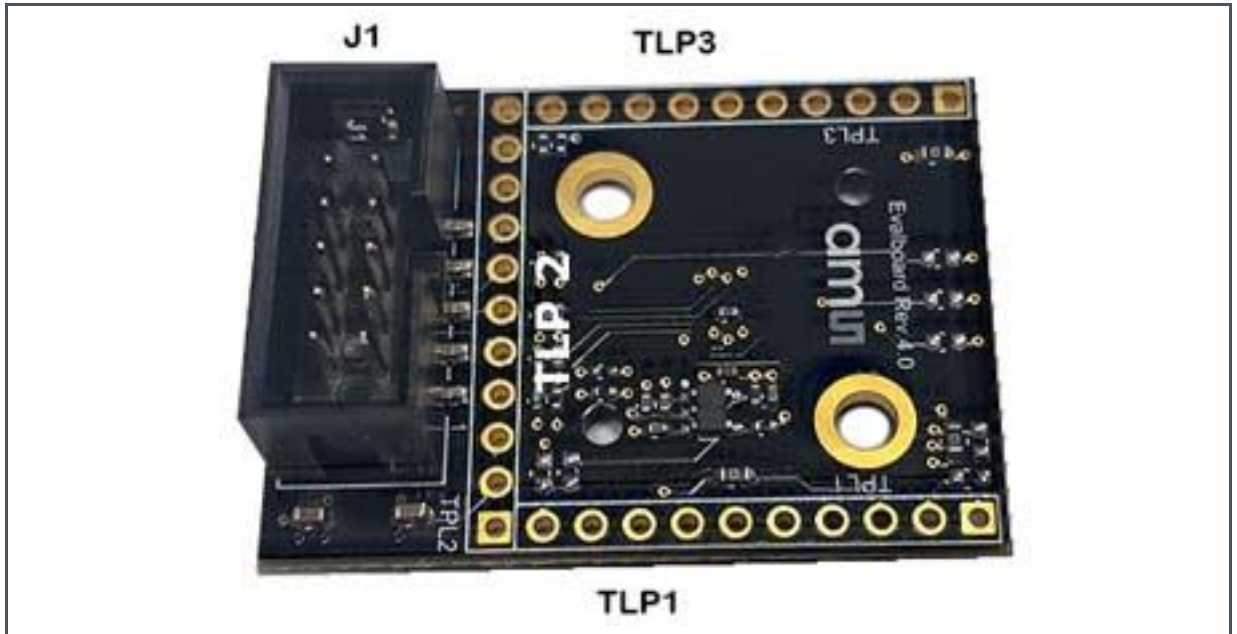


Figure 14:  
Overview of Connectors and Interfaces

Designator	Comment
J1	10-pole IDC socket, connect to PC via FTDI Adapter (3.3 V)
TLP 1	VEXT, LDR, GND, 1V8
TLP 2	5V0, (3V3), I <sup>2</sup> C, INT, GPIO
TLP 3	GND

**Figure 15:  
 Connectors**

Pin Number	Net Name	Function
TLP1 1	VEXT	Supply the optional fitted LEDs from an external source.
TLP1 2	GND	Ground
TLP1 3	LDR	Constant current sink from the sensor chip.
TLP1 4...9	NC	Not connected.
TLP1 10	1V8	External power supply - before using this pin, disassemble the LDO.
TLP 2 1	GND	Ground
TLP 2 2	NC	5V0 power input if there is no power on J1 (FTDI adapter) or 5V0 power output, if the power comes over J1.
TLP 2 3	3V3	3V3 power output from the LDO.
TLP 2 4	GND	Ground
TLP 2 5	SDA	I <sup>2</sup> C data signal
TLP 2 6	SCL	I <sup>2</sup> C clock signal
TLP 2 7	INT	Sensor chip interrupt signal
TLP 2 8	GPIO 2	GPIO signal, bridged to the FTDI adapter.
TLP 2 9	GND	Ground
TLP 2 10	GPIO 3	GPIO signal, bridged to the FTDI adapter and sensor chip.
TLP 2 11	SDA2	Is normally bridged to SDA, only needed for FTDI adapter.
TLP 3 1..5, 7..10	NC	Not connected.
TLP 3 6	GND	Ground
J1 1	NC	Not connected.
J1 2	3V3	3V3 power input from the FTDI adapter.
J1 3	GND	Ground
J1 4	SDA	I <sup>2</sup> C data signal
J1 5	SCL	I <sup>2</sup> C clock signal
J1 6	INT	Sensor chip Interrupt signal.
J1 7	GPIO 2	GPIO signal, bridged to TPL 2.
J1 8	GND	Ground
J1 9	GPIO 3	GPIO signal, bridged to the sensor chip.
J1 10	SDA2	Is normally bridged to SDA, only needed for FTDI adapter.

## 4 Optical Diffuser

For non-diffuse applications<sup>5</sup>, such as light detection from a light source, a translucent diffuser in front of the AS7343 EVK is required - which uses scattering centers to spread incoming directed light in pseudorandom directions. These scattering centers can be tiny surface structures on the top (e.g. grounded glass) or small white particles inside (e.g. opal glass) the diffuser. This property divides diffusers into two main groups of surface diffusers and volume diffusers. The selection of a diffuser depends on the use case, the irradiance, the angular distribution of the light, and the needed flexibility of the setup in a fixed or mobile application.

A surface diffuser with high transmission and a radiation pattern as wide as possible should be used in the case of low light measurement applications.

Narrowing the radiation pattern for higher transmission efficiency is only possible for detecting large and homogenous light sources or if the conditions for calibration are the same as measurement geometry and stability. Calibration can compensate for stable conditions, chromatic effects, deviations, and others. In applications under changing conditions, regarding size, direction, and/or orientation of the light source, a volume diffuser with nearly Lambertian and achromatic characteristics is the best choice to create a sensor system that is not affected by the direction of incoming light.

In addition to the technical aspects, its material thickness, surface (robustness), availability, and price, also play an important role in the selection of the diffuser. Compromises may be necessary.

Figure 16 lists the recommended diffuser parameters and/or the parameters of the Kimoto diffuser in the EVK (=recommended parameters for a similar diffuser).

**Figure 16:**  
**Recommended Diffuser Parameters<sup>(1)</sup>**

Parameter	Value	Value
Diffuser Material	Kimoto 100 PBU	Kimoto OptSaver L-57
Diffuser Thickness	125 Microns	100 Microns
Transmission	66 %	60%
Haze	89.5 %	93.1 %
Half-Angle	35.5°	57°

(1) The EVKs can either contain the 100 PBU or are equipped with the L-57 type. Information about this can be obtained from the ams OSRAM support.

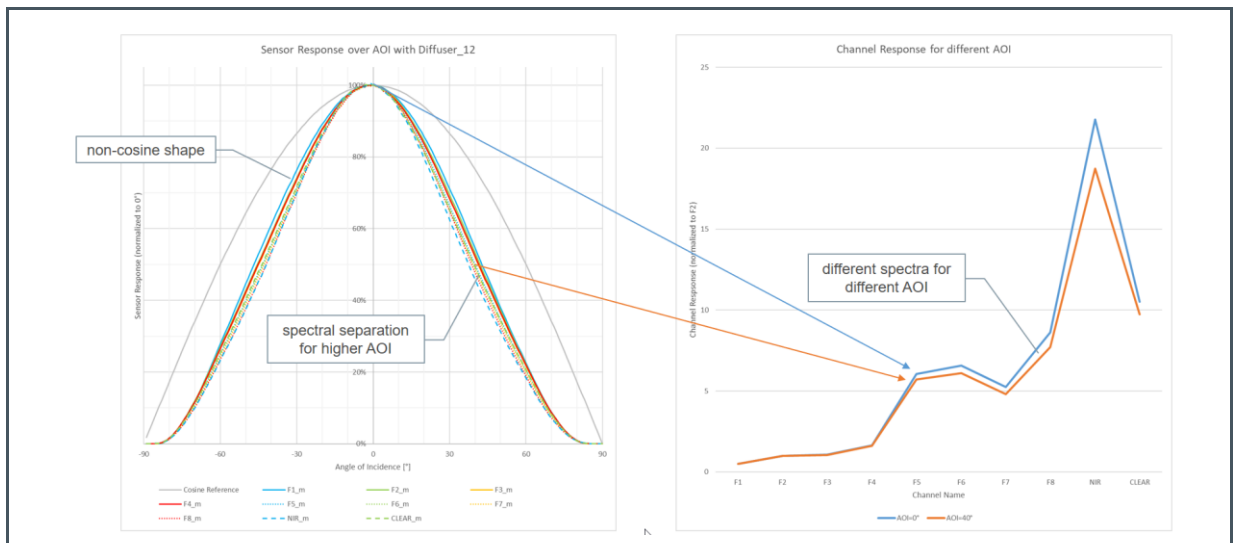
<sup>5</sup> Example: Ambient Light Sensing (ALS) in contrast to reflections which are mostly diffused.



The AS7343 EVK currently includes a Kimoto 100 PBU diffuser directly above the sensor. This diffuser has good technical parameters (see Figure 16), taking into account the price and availability. It is located in two simple plastic shells and screwed onto the Evaluation Kit (see Figure 19).

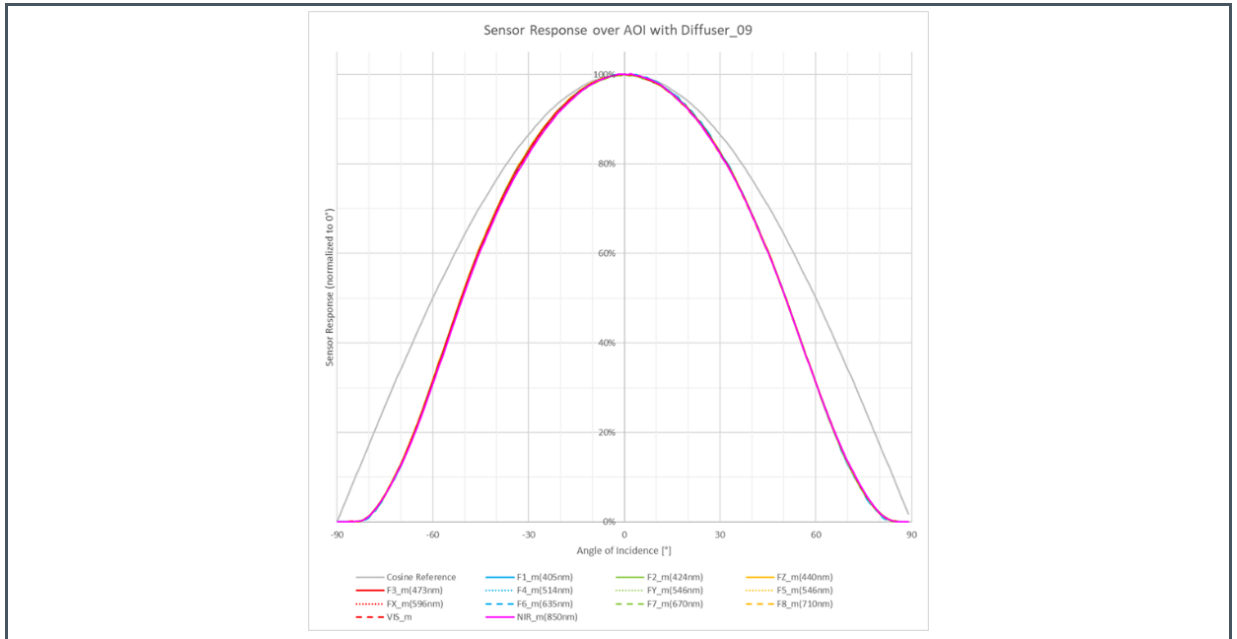
One effect of the PBU-100 diffuser is somewhat dependent on the incident angle of the light. Figure 17 shows the spectral change for different irradiation angles of the PBU-100 which can lead to deviations in dynamic applications depending on the application.

**Figure 17:**  
**Angle Dependence of the Kimoto 100-PBU for Spectral Scanning**



For such cases, alternative diffusers can be used, which differ, for example, in angular dependence and possibly other parameters. One such diffuser is the 'Kimoto OptSaver L-57' type, which has better angular consistency but similar technical parameters to the others.

**Figure 18:**  
Angle Dependence of Kimoto OptSaver L-57 for Spectral Scanning



**Figure 19:**  
Installation of Diffusor Holder ALS<sup>(1)</sup>



<sup>(1)</sup> The assembly is similar for the AS7343 EVK Reflection and/or the backside adapters.



**Information**

The diffuser specification depends on the customer’s application. Therefore, check the technical parameters of the standard diffuser for technical details before you start any tests. Changing the diffuser is possible. Be careful not to touch the diffusers with your fingers, in case of any mounting activities. The surface of the diffusers is sensitive, and any touches, mechanical stress, or dirt can dramatically change the optical behavior. Changing the diffuser and re-assembling typically changes the calibration parameters and requires recalibration for optimal results.

---

## 5 Correction and Calibration

---

The purpose of correction and calibration is to compensate for product-, production- and situation-related disturbances, influences and deviations of the sensors in the application. These can be fixed and unchanged values, as well as influences over time. Here, the independent sensor signal correction, as well as the equal purchase of all sensors of a series, are the target. Furthermore, the matching, i.e. the conversion of the sensor signals into the unit of measurement of the application with optimal accuracy, is another goal of the correction or calibration.

The AS7343 is a 14-channel spectral sensor. The sensor can be calibrated with a spectral calibration matrix, which includes correction data to get a reconstructed spectrum, or directly via XYZ correction data per channel in the visible range (VIS) to get XYZ coordinates as sensor results. Of course, balance methods are also possible at any time to evaluate spectral fingerprints with the sensor.

All algorithms and examples for these standard calibration modes are described in the sensor documents and can be used for the AS7343 after adjusting the number of channels. The same applies to the simple spectral use of individual channels or groups or in comparison of their ratios. Examples for the correction and use of such spectral fingerprints are also included in these documents and are not described here.

Compared to other spectral sensors, the AS7343 contains overlapping narrowband band passes<sup>6</sup>, distributed at approximately equal intervals over the visible wavelength range. It also contains three color channels following the CIE1931 XYZ color standard, plus overlapping narrowband spectral channels to the left and right of each color channel, for their adjustment and parameterization or correction.

Summarized, band passes were designed in the AS7343 as XYZ functional channels plus complementary band passes for parameterization. As a result, the AS7343 contains necessary XYZ channels with the possibility of their parameterizations for a high accurate CIE1931 based color measurement and derived variables like CCT and lux. It further includes band passes for spectral reconstruction and fingerprint band passes as well as further function channels for flicker, Hg+ (fluorescence peak) and NIR detection to identify better special light sources. Thus, the AS7343 fulfills all requirements to perform a spectral reconstruction, but it is designed to perform especially CIE1931 measurements very well. Therefore, its focus for calibration is on color measurement. Therefore, the appropriate method here is the direct XYZ calibration of the color channels plus their parameter trimming channels by means of standard observer function for ALS and by means of color targets for reflection.

---

<sup>6</sup> Functional channels such as flicker, NIR, and clear, which play a minor role in the spectral reconstruction or XYZ calibration considered, are excluded from the comparison here.

---

## 6 Software

---

### 6.1 Initialization Files

The initialization files (see Figure 10) supply important parameters for the GUI. Customers can adapt these files but note that changes of any specified parameters in these files can dramatically affect the sensor results and accuracy. It is recommended to create a backup file of the initialization files before changing them.

The initialization files<sup>7</sup> are saved on the hard disk in the directory '`C:\Users\user\AppData\Roaming\ams-OSRAM\AS7343 Demo`' after the installation of the GUI. In the case of an AS7343 demo with an onboard EEPROM, the parameters from all initialization files are located in the EEPROM and are loaded from there.

- '`Init_file.txt`' – This is necessary for all the GUI functions. It includes values to control functions and limitations, e.g. sensor signal correction, light detection.
- '`CM_x1_v1_0_0.csv`' – Correction matrices for  $x=L$ , where  $L$  = Light measurement and  $x=R$  Reflection mode.
- '`Mask_x_v1_0_0.csv`' – Database for  $x=L$ , where  $L$  = Spectral Mask Compare (Light measurement) and  $x=R$  Color Recognition (Reflection mode).

Comments are not considered by the GUI and can be done as any comment in all initialization files with the characters '`//`' at the beginning of a line.

All initialization files must be checked and changed before the GUI is started. After starting the GUI there is no possibility to change parameters.

The syntax and format of all parameters in the initialization files are fixed and dependent on the MS Window region of the computer used.

Note the GUI comments in the status window if syntax errors occur when reading the initialization files.

#### 6.1.1 Init\_file.txt

'Init\_file.txt' can include the following commands and parameters.

- `xxxxxxFile: xxxxxx.csv`: These are the standard or user-defined files for calibration (see the previous section), spectral compare, and other functions, which are used by the GUI as input files (in case of no EEPROM hardware version). Otherwise, the GUI will generate a file selection dialog box to select these files after choosing the application light or Reflection mode.
- `ChannelOrder={Fx;F...}`: This defines the channel assignment as used in the GUI for all correction values and in the input data from the channel order (default is `F1;F2;FZ;F3;F4;FY;F5;FXL;F6;F7;F8;NIR;VIS`).

---

<sup>7</sup> Change the AppData directory properties in case the directory or subdirectories are not visible or read-only.

- ‘Offset’: Use this to correct constant issues in the sensor setup for tests. The specified values for the single channels F1 to F8, Clear, and NIR in the Init\_file, will be added/subtracted from Basic\_Count after gain correction. The result will be the corrected count. Therefore, the offset must be specified in the form of gain-corrected Basic\_Counts (see Figure 35). Use the offset correction, for example, to compensate for ambient light, optical overcrossing, or other constant deviations. The offset in the Init\_file refers only to all functions in the basic window. The offset for ALS and Reflection Mode is defined in the calibration data files separately. If not mentioned in the calibration files, offset will be used from the Init\_file or can be measured and set with the ‘CTRL+O’ key combination<sup>8</sup>. When offset values are not defined in any of the files, the default value of zero is considered for each channel.
- ‘CorrectionFactor’: This is the scale sensor response by multiplication of the single Correction Factors (=balancing). The specified factors for the single channels will be multiplied (see Figure 35). Use this correction factor as a vector for customized calibration (see chapter 5), e.g. to compensate for the effects of diffusers or other balance operations. The correction factor in the Init\_file only refers to the functions in the basic window. The correction factors for ALS and Reflection Mode are defined in the calibration data files separately. If not mentioned in these files, it will choose from the Init\_file. When the correction factors are not defined in any of the files, the default value ‘1’ is taken for each channel.
- ‘CorrectionGain’: (Vector Based – see Figure 20) Use this to correct the GainError. The given numbers per gain stage are used for all channels as an averaged correction value. When the correction parameters for gain are not defined in the Init\_file, the default value ‘1’ is taken for each channel and gain.

Figure 20:

Example of Correction Gain Vector – for Gain = **0.5** the Value **1.06792** Is Used for All Channels

```
// The correction factor (averaged values in vector) for gain error
// Averaged values for each gain stage
// 0.5x;1x;2x;4x;8x;16x;32x;64x;128x;256x;512x;1024x;2048x
CorrectionGain=1.06792;1.06715;1.05953;1.05246;1.09292;1.09269;1.08115;1.07461;1.06792;1.05969;1;1.01668;0.98010
```

- ‘Gain’: (Matrix Based – see Figure 21) Use this to correct the GainError. The given numbers per gain stage are used for all the channels as an averaged correction value. When the correction parameters for gain are not defined in the Init\_file, the default value ‘1’ is taken for each channel and gain.

<sup>8</sup> In this case, the latest measured sensor results will be used as the offset. It will temporarily overwrite all other defined offset values until the GUI is stopped, and the process asks to save the new offset in the init\_file or EEPROM.

Figure 21:  
Example Correction Gain Matrix – for Gain = 64 and Channel F1 the Value 1.05 Is Used

```
//The correction factor matrix for gain error;
Gain;//F1;F2;FZ;F3;F4;FY;F5;FXL;F6;F7;F8;NIR;VIS
0.5;1;1;1;1;1;1;1;1;1;1;1;1;1;1;1
1;1;1;1;1;1;1;1;1;1;1;1;1;1;1;1
2;1;1;1;1;1;1;1;1;1;1;1;1;1;1;1
4;1;1;1;1;1;1;1;1;1;1;1;1;1;1;1
8;1;1;1;1;1;1;1;1;1;1;1;1;1;1;1
16;1;1;1;1;1;1;1;1;1;1;1;1;1;1;1
32;1;1;1;1;1;1;1;1;1;1;1;1;1;1;1
64;1.05;1.05;1.05;1.05;1.05;1.05;1.06;1.05;1.05;1.05;1.05;1.05;1.05
128;1.05;1.05;1.05;1.05;1.05;1.05;1.05;1.05;1.05;1.05;1.05;1.05;1.05
256;1.03;1.03;1.03;1.03;1.03;1.03;1.03;1.03;1.03;1.03;1.03;1.03;1.03
512;1;1;1;1;1;1;1;1;1;1;1;1;1;1;1
1024;1.03;1.03;1.03;1.04;0.99;1.03;1.02;0.99;1.02;1.04;0.99;1.02;0.99
2048;0.99;0.98;0.95;0.99;0.93;0.96;1.01;0.94;1.01;1.03;0.93;1.00;1.04
```

- ‘MaxAutogain’: Use this to define a maximum for gain in the automatic setup optimization mode. The specified value will be used as an initialization value but can be changed in the GUI.
- ‘MaxAutoTINT’: Use this to define a maximum for TINT in the automatic setup optimization mode. The specified value will be used as an initialization value but can be changed in the GUI.
- ‘Corr\_lx’: Conversion factor from Y (based on the calculated XYZ from the corrected spectrum) to Y(lx). This factor affects only the output of the results for Y(lx) in light detection. If not stated in the initialization file, the default value is ‘683’.
- ‘Limit\_mask’: This will limit the wavelengths for the diagram output and Spectral Mask Compare. The lower and upper limits of the wavelength are considered. By default, the value ‘381’ is taken as the lower limit, and ‘781’ is taken as the upper limit.
- ‘Limit\_Delta\_xy’: XYZ masks with a higher ‘Delta\_xy’ than defined here will not be recognized.
- ‘Limit\_Compare’: Spectral masks with a higher deviation in percent than defined here will not be recognized.
- ‘NIR\_Correction’: Activate the Dynamic NIR compensation algorithm for light detection and Spectral Mask Compare – should be used for Light Detection but not for Reflection mode. If not declared in the file, the default value ‘ON’ is taken into consideration from the Main Tab.
- ‘Limit\_Hg\_Factor’: The ratio of the corrected counts between the channels FY and F5 is checked for the value defined here. If the ratio is smaller than the defined value (typ. = 3), then there is probably a peak at 546nm Hg+ and the last measurement is a fluorescent light source (peak is then displayed symbolically in the reconstructed spectrum in the diagram).
- ‘Delta\_uv’/‘LowerLimit\_u’/‘UpperLimit\_u’/‘UpperLimit\_v’/‘minCCT’/‘maxCCT’: Specifies the parameters, which are the conditions and limitations for CCT calculations in light detection. These values directly affect the CCT calculation. When not mentioned in the Init\_file the following default values are taken: Deltauv = 0.2000, LowerUlimit = 0.1807, UpperUlimit = 0.3988, LowerVlimit = 0.3624, UpperVlimit = 0.5408, MinCCT = 2000, MaxCCT = 7000

## 6.1.2 Calibration\_matrix\_file

The calibration matrices are CSV files, which include correction and calibration data for application-specific analysis – ALS Light Detection and/or Reflection mode:

- 'LEDCurrent': Only for Reflection mode, these values will be used for actual measurements.
- 'LEDxxx': Toggle LED on/off (xxx=[Left, Top, Bottom]).
- 'CorrectionWhiteBalance': Can be used for balancing calibrated XYZ values from the reconstructed spectrum to white or another used target.
- 'CorrectionGain': Vector and Matrix Based – see chapter 6.1.1
- 'WaitTime': This is defined in the GUI as waiting time between two measurements in ms and possible steps in 10 ms increments. The function does not use the WTIME (LONG) function of the sensor chip.
- 'ReferenceWhiteBalance': If a white balance is made in the GUI with the command 'Ctrl+B', the GUI uses the comparison values XYZ to calculate the white balance.
- 'CorrectionWhiteBalance': If available, these values are generally applied as white balance and correction vector for XYZ.
- 'ConversionXYZ2RGB': Here, a general 3x3 matrix is specified for the conversion of the measured XYZ into RGB colors for the screen print in Reflection Mode.
- Calibration matrix: This will be used for the calibration process by matrix multiplication. A special syntax in the calibration file is used to define the calibration matrix (see the 'CM\*.csv' file after software installation, in the directory for the initial data or later in this chapter).
- 'Offset': Use this to correct constant issues in the sensor setup for tests. The specified values for the single channels F1 to F8, Clear, and NIR in the Init\_file will be added or subtracted from Basic\_Counts after gain correction. The result will be Corrected\_Counts. Therefore, offset must be specified in the form of gain corrected Basic\_Counts (see Figure 35). Use the offset correction, for example, to compensate for ambient light, optical overcrossing, or other constant deviations. Offset in the Init\_file refers only to all functions in the basic window. The offset for ALS and Reflection Mode is defined in the calibration data files separately. If not mentioned in calibration files, offset will be used from the initialization files or can be measured and set with the 'CTRL+O' key combination<sup>9</sup>. When offset values are not defined in any of the files, the default value of zero is considered for each channel.
- 'Correction Factor': This is the scale sensor response by multiplying the single Correction Factors (=balancing). The specified factors for the single channels F1 to F8, Clear, and NIR in the Init\_file, will be multiplied (see Figure 35). Use this correction factor for customized calibration (see chapter 5), e.g. to compensate for the effects of diffusers or other balance operations. The correction factor in the Init\_file only refers to the functions in the basic window. The correction factors for ALS and Reflection Mode are defined separately in the calibration data files. If not mentioned in these files, it will choose from the Init\_file. When correction factors are not defined in any of the files, the default value '1' is taken for each channel.

---

<sup>9</sup> In this case, the latest measured sensor results will be used as an offset and temporarily overwrite all other defined offset values until the GUI will be stopped and the process asks before to save the new offset in the Init\_file or EEPROM.



---

### Information

Here, the defined parameters replace the specified values from 'Init\_file.txt' (see chapter 6.1.2).

---

The calibration matrices are part of the software setup and represent general solutions for the demonstration of the Evaluation Kits. They are based on the specified AS7343 filter definitions, components on the evaluation kits, and the existed conditions during calibration. They do not consider any real existing series deviations. Therefore, deviations in the sensor results compared with spectrometers are possible<sup>10</sup>.

In spectral matrices, the maximum and minimum of the used wavelengths and step sizes determine the dynamic (min and max) and spectral steps of the reconstructed spectrum. In general, the calibration matrix determines the dimension of the corrected vector values after matriculation according to the mathematical rules for matrix multiplication.

### 6.1.3 Mask\_files

A spectrum in ALS Light Detection can be used to detect the type of luminary or calculate CIE1931 xyz standard values, xyz, uv, Y (lux), CCT, and CRI. In Reflection mode, the result of the comparison can be a recognized and/or identify the color in the CIE1931 color space. The aim is to identify the measured quantities in a set of defined masks in all applications. Such masks are defined in the file 'Mask\_x\_v1\_0\_0\_.csv'. These masks were predefined in a format that must also be used in the calibration file (XYZ or spectrum). The dimensions of the mask file depend on the corrected sensor values and calibration matrix (CM). Changes in the CM make it necessary to adapt the mask file.

The process for Spectral Mask Compare is a simple algorithm based on the sum of standard deviations by comparison of each wavelength of two normalized spectra, the reconstructed spectrum from the last measurement, with a masking spectrum from the Mask Compare database. Each mask will be checked in its dimensions (wavelengths or Tristimulus values; only the data from the mask file is taken) for deviations from the actual sensor values. The recognized result is the mask with the smallest deviation given in the mask file, or the process will stop without recognition in case all the calculated deviations are greater than 'Limit\_Compare' from the Init\_file. It is possible to create or adapt the mask file in the GUI. See chapter 6.8. for more details.

The GUI uses the calibration and mask files from the standard installation or selected by the user via a pop-up selection window. Users can teach or also add spectral masks in case of the selection of ALS or Reflection mode. The new spectral mask data are saved into the previously selected mask's CSV file.

---

<sup>10</sup> Calibration, effort, and accuracy, always depend on customer-specific requirements. Use alternative calibration methods to increase accuracy in general. A device-to-target calibration, where the sensor and reference values are calculated to get the device-specific Calibration matrix, will achieve the highest accuracy. A good compromise between effort and accuracy is to use the general calculation matrix with a peak adjustment to a Golden device.



**Figure 22:**  
Example of a MaskFile for Ambient Lighting

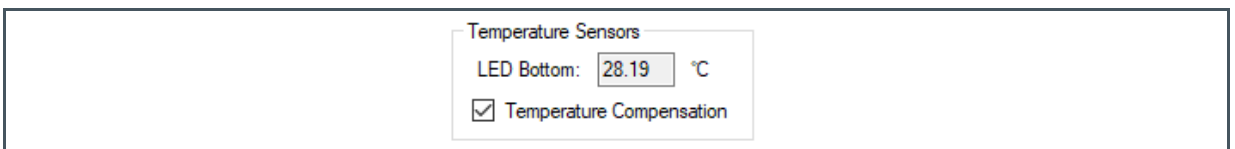
```
// The light source matrix with Title to define the mask_names, CCT (optional) as given CCT[] for the Mask and spectral data's for the single masks
Title;CWF_Sen;D65_Sen;HZ_Sen;Ind A_Sen;TL84_Sen;U30_Sen;LightBulb_Red;Halogen_Red;LL_LW_Red;LL_KW_Red;GTI Day;GTI Home;GTI Store;GTI Store + Home;CCT;4337;6727;2264;2985;3996;2958;2659;2928;2743;5179;5994;3245;3821;3524;4189;4697;4448;5817;5850
380;0.00785000;0.01756000;0.00190000;0.00457000;0.00285000;0.00231000;0.00114000;0.00113000;0.00078000;0.00007000;0.00357000;0.01377000;0.00165000;
381;0.00712000;0.01773000;0.00192000;0.00461000;0.00288000;0.00233000;0.00115000;0.00114000;0.00078000;0.00007000;0.00361000;0.01391000;0.00167000;
382;0.00719000;0.01791000;0.00194000;0.00466000;0.00291000;0.00236000;0.00117000;0.00115000;0.00079000;0.00007000;0.00365000;0.01405000;0.00169000;
383;0.00726000;0.01810000;0.00197000;0.00471000;0.00294000;0.00238000;0.00118000;0.00117000;0.00080000;0.00007000;0.00368000;0.01420000;0.00170000;
384;0.00734000;0.01828000;0.00198000;0.00475000;0.00297000;0.00241000;0.00119000;0.00118000;0.00081000;0.00007000;0.00372000;0.01434000;0.00172000;
385;0.00741000;0.01846000;0.00200000;0.00480000;0.00300000;0.00243000;0.00120000;0.00119000;0.00082000;0.00008000;0.00376000;0.01448000;0.00174000;
386;0.00748000;0.01865000;0.00202000;0.00485000;0.00303000;0.00246000;0.00121000;0.00120000;0.00082000;0.00008000;0.00380000;0.01463000;0.00175000;
387;0.00756000;0.01884000;0.00205000;0.00490000;0.00306000;0.00248000;0.00123000;0.00121000;0.00083000;0.00008000;0.00383000;0.01478000;0.00177000;
388;0.00764000;0.01903000;0.00206000;0.00495000;0.00309000;0.00251000;0.00124000;0.00123000;0.00084000;0.00008000;0.00387000;0.01493000;0.00179000;
389;0.00771000;0.01922000;0.00208000;0.00500000;0.00312000;0.00253000;0.00125000;0.00124000;0.00085000;0.00008000;0.00391000;0.01508000;0.00181000;
390;0.00779000;0.01941000;0.00210000;0.00505000;0.00316000;0.00256000;0.00126000;0.00125000;0.00086000;0.00008000;0.00395000;0.01523000;0.00183000;
391;0.00787000;0.01961000;0.00212000;0.00510000;0.00319000;0.00259000;0.00128000;0.00126000;0.00087000;0.00008000;0.00399000;0.01538000;0.00185000;
392;0.00795000;0.01981000;0.00214000;0.00515000;0.00323000;0.00262000;0.00129000;0.00128000;0.00088000;0.00008000;0.00403000;0.01554000;0.00186000;
393;0.00804000;0.02000000;0.00216000;0.00520000;0.00327000;0.00265000;0.00130000;0.00129000;0.00089000;0.00008000;0.00407000;0.01570000;0.00188000;
394;0.00812000;0.02021000;0.00218000;0.00525000;0.00332000;0.00268000;0.00131000;0.00130000;0.00090000;0.00009000;0.00411000;0.01585000;0.00190000;
395;0.00821000;0.02041000;0.00220000;0.00530000;0.00336000;0.00272000;0.00133000;0.00131000;0.00091000;0.00009000;0.00416000;0.01601000;0.00192000;
396;0.00830000;0.02061000;0.00221000;0.00535000;0.00341000;0.00275000;0.00134000;0.00133000;0.00092000;0.00009000;0.00420000;0.01616000;0.00194000;
397;0.00839000;0.02082000;0.00223000;0.00541000;0.00347000;0.00280000;0.00135000;0.00134000;0.00094000;0.00009000;0.00425000;0.01633000;0.00196000;
398;0.00848000;0.02103000;0.00224000;0.00546000;0.00353000;0.00284000;0.00136000;0.00135000;0.00095000;0.00010000;0.00429000;0.01650000;0.00199000;
399;0.00857000;0.02124000;0.00225000;0.00551000;0.00359000;0.00289000;0.00138000;0.00137000;0.00097000;0.00010000;0.00435000;0.01665000;0.00201000;
400;0.00867000;0.02145000;0.00226000;0.00556000;0.00367000;0.00294000;0.00139000;0.00138000;0.00098000;0.00010000;0.00440000;0.01681000;0.00204000;
401;0.00877000;0.02166000;0.00226000;0.00560000;0.00375000;0.00300000;0.00140000;0.00139000;0.00100000;0.00011000;0.00446000;0.01696000;0.00208000;
402;0.00888000;0.02187000;0.00226000;0.00565000;0.00384000;0.00306000;0.00141000;0.00141000;0.00102000;0.00011000;0.00453000;0.01711000;0.00212000;
403;0.00899000;0.02209000;0.00226000;0.00570000;0.00394000;0.00313000;0.00143000;0.00142000;0.00105000;0.00012000;0.00461000;0.01725000;0.00216000;
404;0.00910000;0.02230000;0.00226000;0.00575000;0.00405000;0.00321000;0.00144000;0.00143000;0.00107000;0.00013000;0.00470000;0.01737000;0.00221000;
405;0.00922000;0.02252000;0.00226000;0.00580000;0.00417000;0.00330000;0.00145000;0.00145000;0.00110000;0.00013000;0.00479000;0.01750000;0.00226000;
```

### 6.1.4 Temperature Compensation File

If the sensor board supports temperature correction with an on-board temperature sensor, and if the temperature per channel is to be corrected<sup>11</sup>, the option can be actively selected for correction in the GUI. In this case, it opens a selection window for selecting the temperature compensation and the corresponding file.

The file, in CSV format, contains in column 1, the temperature in °C, and the correction values for the all sensor channels in the following columns. The temperatures must be entered in an orderly sequence (from low to high) in range per line for one temperature and represent correction factors per channel and temperature or a global factor for all channels per temperature which will also be multiplied with the Basic\_Counts in the correction steps.

**Figure 23:**  
Activated Temperature Compensation in the GUI - Open Temperature Correction File



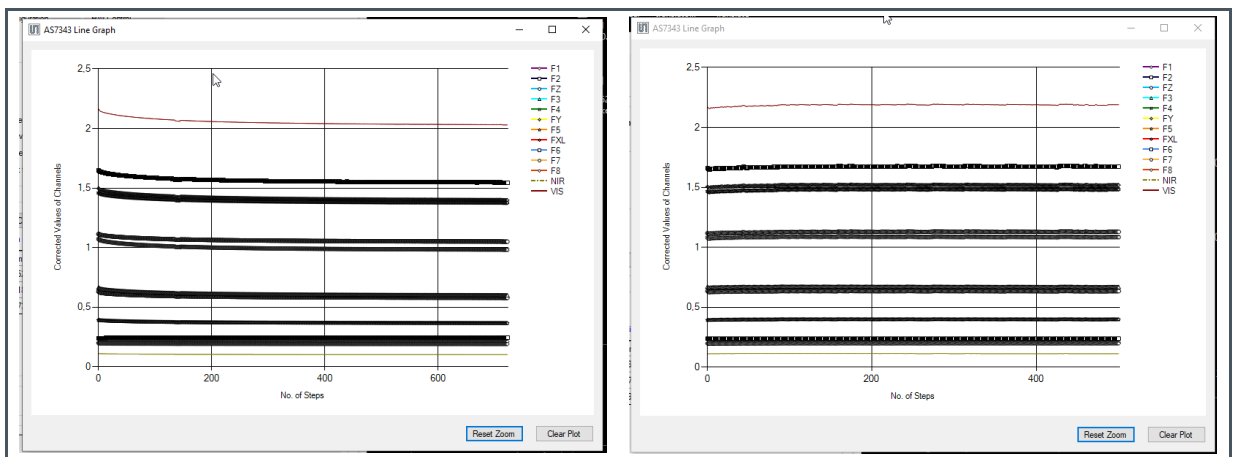
<sup>11</sup> Temperature drifts occur from all system components, especially from LEDs. Corrections are only valid if the same conditions apply when measuring such as when generating the correction functions. After that, the correction values or functions only apply when using the same components.

Figure 24:  
Part of Temperature Compensation File

Temp [degC]	F1	F2	FZ	F3	F4	FY	F5	FXL	F6	F7	F8	NIR	VIS
0	1,011974	1,017855	0,92633	0,912094	0,919898	0,933788	0,932957	0,940545	0,935679	0,942493	0,972289	0,923853	0,940008
1	1,011513	1,017168	0,929163	0,915475	0,922979	0,936335	0,935536	0,942831	0,938153	0,944705	0,973354	0,926782	0,942315
2	1,011053	1,016481	0,931997	0,918856	0,92606	0,938881	0,938115	0,945118	0,940627	0,946917	0,97442	0,92971	0,944623
3	1,010592	1,015795	0,93483	0,922237	0,929141	0,941428	0,940693	0,947405	0,9431	0,949128	0,975486	0,932639	0,94693
4	1,010132	1,015108	0,937664	0,925618	0,932222	0,943975	0,943272	0,949692	0,945574	0,95134	0,976552	0,935568	0,949237
5	1,009671	1,014421	0,940497	0,928999	0,935302	0,946521	0,94585	0,951978	0,948048	0,953552	0,977618	0,938497	0,951545
6	1,009211	1,013735	0,94333	0,93238	0,938383	0,949068	0,948429	0,954265	0,950522	0,955764	0,978683	0,941425	0,953852
7	1,00875	1,013048	0,946164	0,935761	0,941464	0,951615	0,951007	0,956552	0,952996	0,957976	0,979749	0,944354	0,95616
8	1,00829	1,012361	0,948997	0,939142	0,944545	0,954161	0,953586	0,958839	0,95547	0,960187	0,980815	0,947283	0,958467
9	1,007829	1,011674	0,951831	0,942523	0,947626	0,956708	0,956164	0,961125	0,957944	0,962399	0,981881	0,950212	0,960774
10	1,007369	1,010988	0,954664	0,945904	0,950707	0,959254	0,958743	0,963412	0,960418	0,964611	0,982947	0,95314	0,963082
11	1,006908	1,010301	0,957498	0,949285	0,953787	0,961801	0,961322	0,965699	0,962892	0,966823	0,984013	0,956069	0,965389
12	1,006447	1,009614	0,960331	0,952666	0,956868	0,964348	0,9639	0,967986	0,965365	0,969035	0,985078	0,958998	0,967696
13	1,005987	1,008927	0,963165	0,956047	0,959949	0,966894	0,966479	0,970272	0,967839	0,971246	0,986144	0,961926	0,970004
14	1,005526	1,008241	0,965998	0,959428	0,96303	0,969441	0,969057	0,972559	0,970313	0,973458	0,98721	0,964855	0,972311

Figure 25 shows results of tests in reflection mode without and with temperature compensation.

Figure 25:  
Line Graph without/with Temperature Correction in Reflection Mode (Delta T = 30 K)

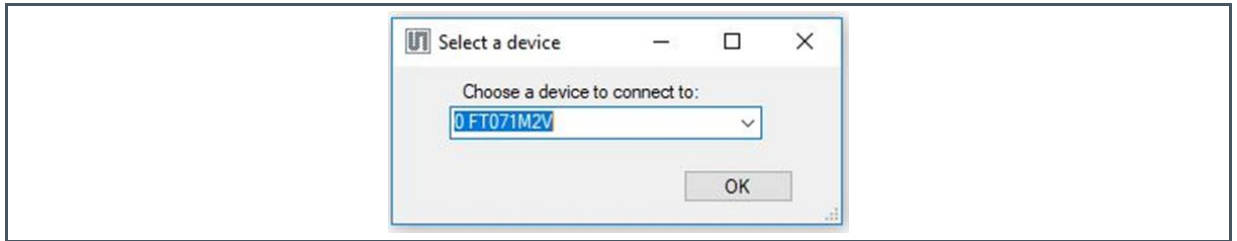


## 6.2 EVM Graphical User Interface

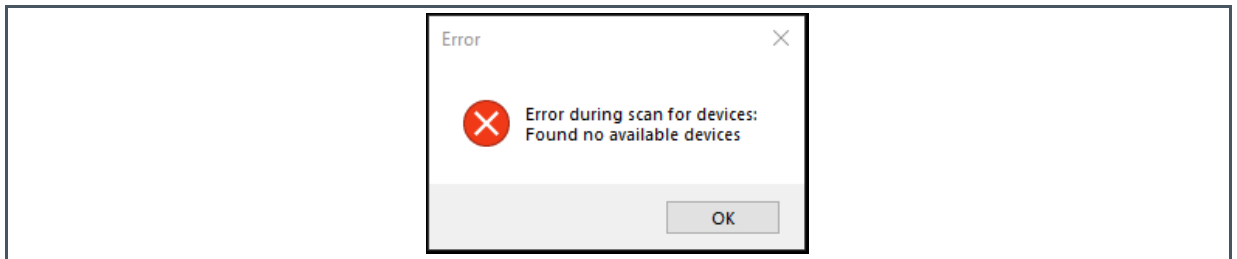
Connect the sensor board hardware to the system via an FTDI cable and double-click the software icon to open the GUI. If there are more than two FTDI cables connected to the computer, a pop-up window will appear, as shown below in Figure 26. Please select the correct cable used for the sensor board and click OK. If there is only one FTDI cable, the software will automatically select the cable connected. When the connection is good, the bottom section in the GUI will display the positive status of the FTDI connection, FTDI cable series number, auxiliary sensor ID, revision, and part number.

An error message is output if the connection to the sensor board cannot be realized via FTDI (see also chapter 7).

**Figure 26:**  
**Window for FTDI Cable Selection if Multiple FTDI Cables Are Connected**



**Figure 27:**  
**GUI Error Message If No Device Can Be Found**



Check the part number, including any 0x-code, in case of any issues. A code 0x zero indicates no connection to the sensor hardware. In case of a problem, check the USB driver installation and connections, then restart the software, or use the scan function in the menu File. The GUI will automatically open when launching the software. If no device is connected, an error message will pop up. When the GUI starts showing a red indicator at the bottom section of the FTDI connection, connect a device, navigate to the 'File' window in the top corner of the GUI, and click 'Scan and connect'. The GUI will relaunch with the device connected. Use the 'Disconnect' button to terminate the connection, and click the 'Exit' button to end the GUI application.

## 6.3 Hot Keys

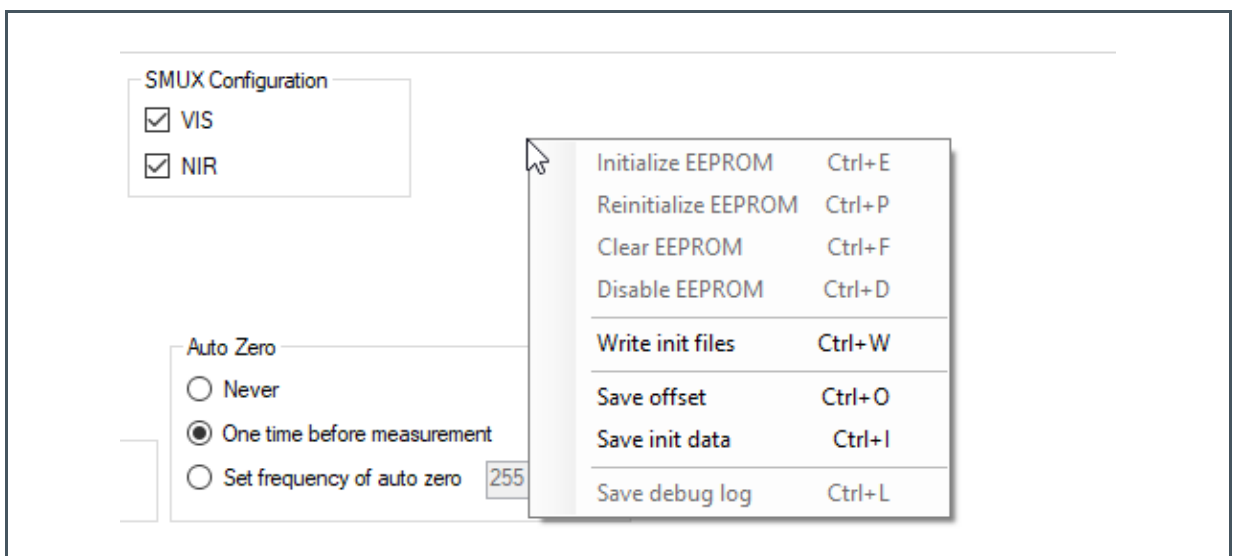
The following hotkeys as 'CTRL-functions' are inserted in the GUI. Alternative, the ctrl-functions are implemented as context menu which can be opened by clicking the right mouse button in the main tab.

**Figure 28:**  
**Commands of the Evaluation Kits and Demonstrators**

CTRL Function	Description
Ctrl + A	Start detection logging (only active when in ALS or reflection mode).
Ctrl + B	Use XYZ reflection XYZ from last the shot as white balance (only active in reflection mode).
Ctrl + C	Stop Script Processing (only active in trace mode and activated process).

CTRL Function	Description
Ctrl + D	Disable the EEPROM, GUI uses data directly from the directory (EEPROM commands are only active for EEPROM compatible devices).
Ctrl + E	Initialize or re-write the EEPROM with the files from the directory (EEPROM commands are only active for EEPROM compatible devices).
Ctrl + F	Clear the EEPROM (EEPROM commands are only active for EEPROM compatible devices).
Ctrl + I	Write initialization data from memory to the EEPROM or initialization file (EEPROM commands are only active for EEPROM compatible devices).
Ctrl + L	Save Log <sup>12</sup> file during the active session (only active in ALS or reflection mode).
Ctrl + M	Read a new calibration file (only active in ALS or reflection mode).
Ctrl + O	Use Basic_Counts with gain correction from the last shot as offset values.
Ctrl + R	Read mask file (only active in ALS or reflection mode).
Ctrl + S	Save detection logging (only active in ALS or reflection mode).
Ctrl + W	Readout initialization files from the EEPROM to the directory (EEPROM commands are only active for EEPROM compatible devices).
Ctrl + Z	Make a screenshot from a diagram.
Ctrl + left mouse button	Zoom-in diagrams

**Figure 29:**  
Use the Context Menu 'Ctrl-Function' (Click Right Mouse Button in the Main Window To Open It)

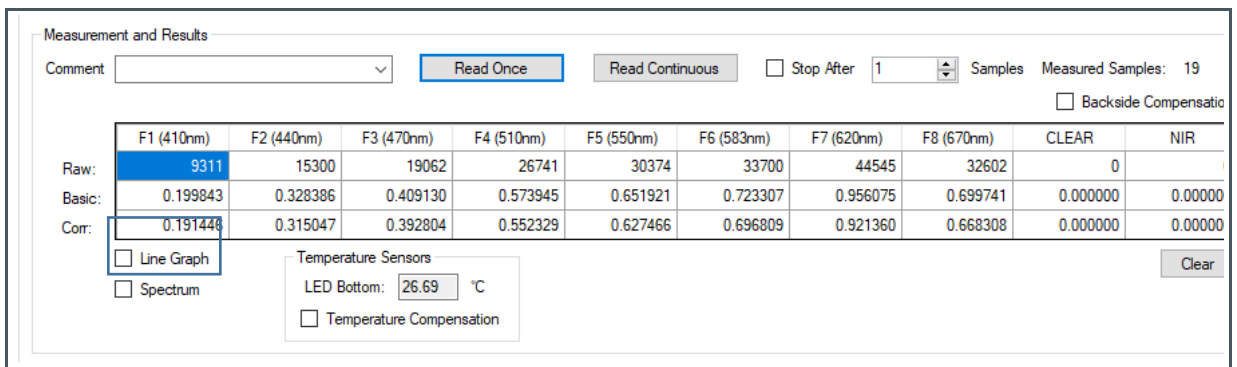


<sup>12</sup> Set in file AS7343\_Demo.config in the user directory the option <add key='LogFileEnable' value='True' /> to activate log files.

## 6.4 Sensor Board Test

1. To check the function of the EVK, start the measurement by pressing the 'Read Once' button (see Figure 30). This executes one measurement step using 'Easy Mode, which will show the measured values in the table based on the sensor's location to a luminary in front of the sensor and its spectrum in another window.
2. Afterward, change the mode to 'Expert Mode'. Then, adjust Integration time and gain, to change the digits based on the application requirements. More details about the sensor functions and the parameters are listed in the sensor's datasheet or later in this manual.
3. Then, select one of the plot options, 'Line Graph' or 'Spectrum', to view the results (Corrected\_Counts) as a graphical output. The table will show the 'RAW', 'Basic', and 'Corrected' values.
4. Lastly, check the given results based on reasonableness and logic. In Easy and Expert mode, by default, the optimization for Gain and Integration time is switched-on. In Expert mode, optimization can be turned off: to increase the parameters for conversion in case of zero digits or decrease in the case of saturation. An increase/decrease should change the counts and values in the table or diagrams. Look for the printed values and check them with the specified commands and parameters in the Init\_file to ensure the GUI works well with all the initialization files.

**Figure 30:**  
**First Sensor Board Test – Output of the First Results in the Main Tab<sup>(1)</sup>**



(1) Filter names may vary

Always check the stability of a test setup before the actual measurements begin. Set the target to its minimum and maximum value, to check the required dynamic range. Ensure the parameter setup for gain and integration time can realize the full dynamic range. Verify any potential drifts, such as temperature effects, and interferences, such as ambient lighting, which affect measurements. For accuracy, verify and delete or compensate for all the effects before starting measurements.

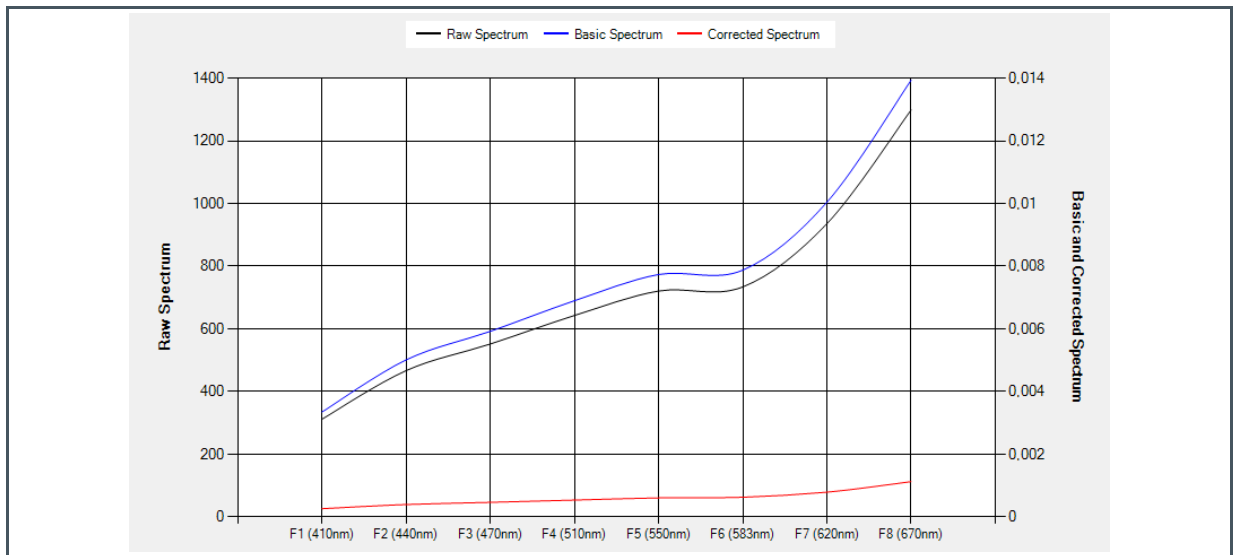
## 6.5 Offset Compensation

Offset is an effect that should be corrected at the beginning after completing the setup and defining all the sensor parameters to obtain the best possible sensor results. For example, in Reflection mode, such an offset is caused by the direct irradiation of the LEDs via the optics on the sensor. This offset is measured directly with the 'set and switched on' LEDs as the sensor result without a target (reflection) in front of the sensor; for example, a setup where the sensor looks into a dark room with activated LEDs).

In general, a measured value can also be defined as an offset, in order to detect deviations from it as the actual signal. This is the case, for example, with backlight compensation, where extraneous light is first measured as an interference source and then compensated as an offset from the actual measured signal. Figure 31 shows a measurement result as a RAW value (black), Basic\_Counts (blue), and Corrected\_Counts (red, with preset standard offset for the kit in the correction), where the sensor measures into a dark room with the activated LEDs.

Although no result is expected from a target in reflection, the sensor naturally shows digital counts as a result, which are caused by internal reflections directly from the LED to the sensor. This error, as the offset, is constant with and without a target, and is independent of the color the sensor measures later. Since the red line is not directly on the zero line, the preset offset can be corrected or not, depending on its absolute size and required accuracy.

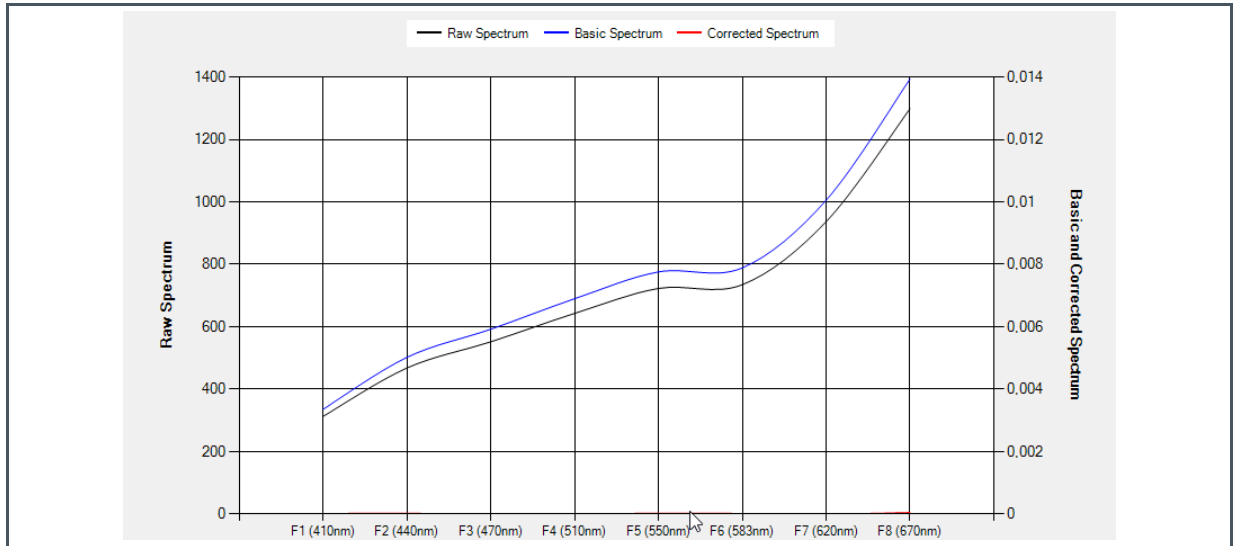
**Figure 31:**  
**Sensor Results without the Correct Offset Correction (See Red Line)**



In general, this correction can be carried out by sensor steps without an offset definition and entering these values as an offset in the INIT file. Alternatively, use 'CTRL+O' to directly measure Offset, and/or 'CTRL+O' will start a measurement, and the measured values will be used as an Offset. Then, the GUI will ask to save this Offset into the Init\_file before it closes. If noise causes negative values

due to offset compensation, the GUI to prevent negative partial spectra automatically shifts the spectrum to the positive.

**Figure 32:**  
**Sensor Results with the Correct Offset Correction (Corrected Values Are On Zero Curve)**



## 6.6 Operation Mode

The GUI has two modes of operation – Easy and Expert mode. Easy mode is selected by default. Users can switch modes by selecting the radio button of the Expert mode. In Easy mode, most of the parameter settings are automatically set. The user has limited permission to make modifications to the parameter settings in Easy mode. Parameters such as Gain, Integration time, LED settings, channel configuration, etc. cannot be changed in Easy mode.

However, optimization of gain and integration time is active during the Easy mode measurements. Easy mode has limitations and restrictions in the application-specific analysis window. Expert mode overcomes all restrictions in Easy mode. Users can also control all the parameter settings in Expert mode. In this mode, the optimization of max AGAIN and Max TINT, to control the gain and integration time, is automatically turned off. Switch them on manually to use it in Automatic mode. For operating the GUI in Expert mode, by default, users can use the 'xxx Demo Version.bat' batch file with the below command and execute the file in 'C:\Program Files (x86)\ams-OSRAM\AS7343 Demo', or create a shortcut icon of this batch file on the desktop. The software version can be edited with this batch file.

Start '...\AS7343\_Demo\_Software.exe' -Expert - Version=x.xx.00.

## 6.7 Main Tab

The Main Tab in Expert mode contains the user interface with control buttons, fields, selection boxes, and output values for the connected device. The Main Tab permits the configuration of the sensor device and initializes the default settings to the devices. It allows the user to modify and configure the integration time setting, Gain setting, LED setting, Auto Zero, 'Dynamic Conversion' (Optimization), and other application-specific sensor functions and demos.

**Figure 33:**  
Main Tab of the GUI

The screenshot shows the 'Main' tab of the AS7343 GUI. It includes sections for Gain (AGAIN: 2048x), Integration Time (Tint: 1275.439 ms), LED Settings (Enable LED, Flash Mode, LED Brightness: 3.1%, LED Current: 8.000 mA), SMUX Configuration (VIS, NIR), Optimization (Max AGAIN, Max Tint, Result AGAIN, Result IntTime, Wait Time), and Auto Zero (Never, One time before measurement, Set frequency of auto zero: 255). The 'Measurement and Results' section features a table of spectral data and a 'Clear' button. At the bottom, there are checkboxes for 'Application Specific Analyses' (Light / Display Detection, Flicker Detection) and a 'Mode' selector (Easy, Expert).

	F1 (400nm)	F2 (424nm)	FZ (450nm)	F3 (473nm)	F4 (514nm)	FY (555nm)	F5 (547nm)	FXL (595nm)	F6 (635nm)	F7 (685nm)	F8 (745nm)	NIR	VIS
Raw:	1328	3446	6823	8908	11335	16213	4316	14762	16728	21832	16864	47212	33765
Basic:	0.000508	0.001318	0.002610	0.003408	0.004336	0.006202	0.001651	0.005647	0.006399	0.008351	0.006451	0.018060	0.012916
Corr:	0.000508	0.001318	0.002610	0.003408	0.004336	0.006202	0.001651	0.005647	0.006399	0.008351	0.006451	0.018060	0.012916



### Information

The higher the counts (before saturation), the better the accuracy. Changing gain or TINT will affect the counts. Both parameters will have different effects like FSR, noise, linearity, time, and others.

### 6.7.1 Integration Time (TINT)

Integration time is one parameter that affects the sensor result (= digital counts or digits). It directly affects the saturation (FSR 16-bit =  $2^{16}$  is reached for the first time at  $182 \text{ ms} = 2.78 \mu\text{s} * 2^{16}$ ), and



is set using ATIME (0x81) and ASTEP (0xCA, 0xCB) registers. The Integration time is displayed in milliseconds and is calculated using Equation 1.

**Equation 1:**

$$tint = (ATIME + 1) \times (ASTEPP + 1) \times 2.78 \mu s.$$

The GUI uses the Integration Time (TINT) parameter in ms.

The Integration time (TINT) parameters, like 'ATIME' and 'ASTEPP', can be set by clicking the up or down arrow button. ATIME sets the number of integration steps from 0 to 255. Set the 'Integration time' per step in increments of 2.78  $\mu$ s. ASTEP sets the Integration time from 1 to 65534 steps. The default configurations in the GUI for these two registers are ASTEP = 0 and ATIME = 65534, which results in an Integration time of 182 ms. The Sensor specification does not allow both settings (i.e. ATIME and ASTEP) to be set to 0.

The integration time has a significant influence on the measurement time, since several measurement cycles with the defined integration time are needed in one measurement. This is due to the limited ADC channels on the sensor chip and that several cycles must be converted over the integration time to digitize all optical channels (number greater than ADC channels – factor 2 ...3 depending on the selected channels for output).

On the other hand, when using the automatic gain, at least two measurements (over several cycles) are necessary to determine the optimized parameters for the ADC. Considering these facts, the measuring time of a measurement is very fast - a multiple of the integration time, *tint* (Measuring time > 2 x (3 x *tint*)). Therefore, the software calculates the expected measurement time based on the settings and displays the measurement progress as a loading bar or writes out a warning if the measuring time is longer than one second.

**Figure 34:**

**Calculated Measuring Time and Loading Bar in the Main Tab if Measuring Time > 1 s**



## 6.7.2 Gain

Gain is the second parameter to affect the Sensor result (= digital counts). The Gain control 'AGAIN' allows the user access to the Gain settings in the 0xAA Register (4:0 bits). The Gain amplifies the signal of the six integrated ADCs to increase sensitivity by switching to a higher Gain value. The Gain options include eleven alternative Gain stages between 0.5x and 512x. Select these options from the drop-down arrow in the list box.

### 6.7.3 Enable Optimization

An algorithm of the GUI will be switched on, which analyzes the sensor output and parameter setting to find an optimal ADC parameter set for gain and TINT at given maximum values. The target for optimization is to achieve a maximum number of digits at high accuracy. Usually, measurements in noise and saturation should be prevented by using this mode. By default, this is ON in the case of Easy mode, and OFF in the case of Expert mode. Optimization of gain is enabled by checking 'Max AGAIN' and denoting the maximum gain value to be considered in the list box beside the checkbox. Similarly, optimization of Integration time is enabled by checking 'Max TINT' and mentioning the maximum value to consider in the list.

### 6.7.4 Wait Time

It is defined in the GUI as the waiting time between two measurements in milliseconds (ms) and possible steps in 10 ms increments. The function does not use the WTIME (LONG) function of the sensor chip.

### 6.7.5 LED Setting (LED Current)

If LEDs are mounted on the sensor board in Reflection mode, enable the switch on the LED and set the LED currents. The current can be set using the up-down controls. It has a range of 1% up to 100% of the supported LED current<sup>13</sup>. Activate Flash mode if the LED is only switched-on during the measurement process.

### 6.7.6 Auto Zero

Auto Zero sets the options and the frequency at which the device performs the auto zero of the spectral engines to compensate for changes in the device temperature.

### 6.7.7 SMUX Configuration

The device integrates a multiplexer (SMUX). With the SMUX, it is possible to map all the available photodiodes to one of the six available light-to-frequency converters (ADCx). After the power-up of the device, the SMUX must be configured before a spectral measurement begins. In the GUI, SMUX is pre-configured to work with all spectral channels, excluding **VIS** and **NIR**, which can be selected separately.

### 6.7.8 Measurement Setting

Select 'Read Once' or 'Read Continuous' to measure systematically or in a Continuous Mode (alternative with a specified number of steps), and/or to stop a Continuous Mode after n steps. The

---

<sup>13</sup> LED current, light intensity and/or maximal driver current are depending on the used LEDs and connected power supply. Check the LED datasheet before using this LED setting. A very high LED current can destroy the LEDs.

ADC results are printed after each measurement as numeric values, presenting RAW\_Counts or calculated Basic\_Counts or Corrected\_CountsValue.

### 6.7.9 Raw\_Counts

Raw\_Counts represent the counts from the ADC, depending on the setup used (SMUX Configuration, Offset, Gain, Integration time, LED-current, etc.).

### 6.7.10 Basic\_Counts

The Basic\_Counts are calculated based on the RAW measurement values and the corresponding Gain and Integration time at that moment - to get sensor results independent of the parameter setup (Gain, TINT).

**Equation 2:**

$$\text{Basic\_Counts} = \text{Raw\_Counts} / (\text{Gain} * \text{TINT})$$

### 6.7.11 Corrected\_Counts

These are the results of the calculations based on specified parameters in init\_list, e.g. Gain\_Correction' or Correction\_Factor and Offset

**Equation 3:**

$$\text{Corrected\_Counts} = \text{Basic\_Counts} * \text{Gain\_Correction} * \text{Correction\_Factor} - \text{Offset}$$

Figure 35 shows the used data flow and the order to make corrections.

Select 'Line Graph' or 'Spectrum' if the sensor results as RAW, Basic, or Corrected\_Counts - they should be presented as diagrams. The diagram window includes some functions to adapt the graphical output in wavelength and data (see Figure 39). The diagrams can be saved on a hard disk as a bitmap file or any other format by selecting the key combination 'Ctrl + Z'.

### 6.7.12 Status

This is a user interface and shows the GUI messages and/or failure reports.

**Figure 35:**  
**Data Flow Used in the GUI**

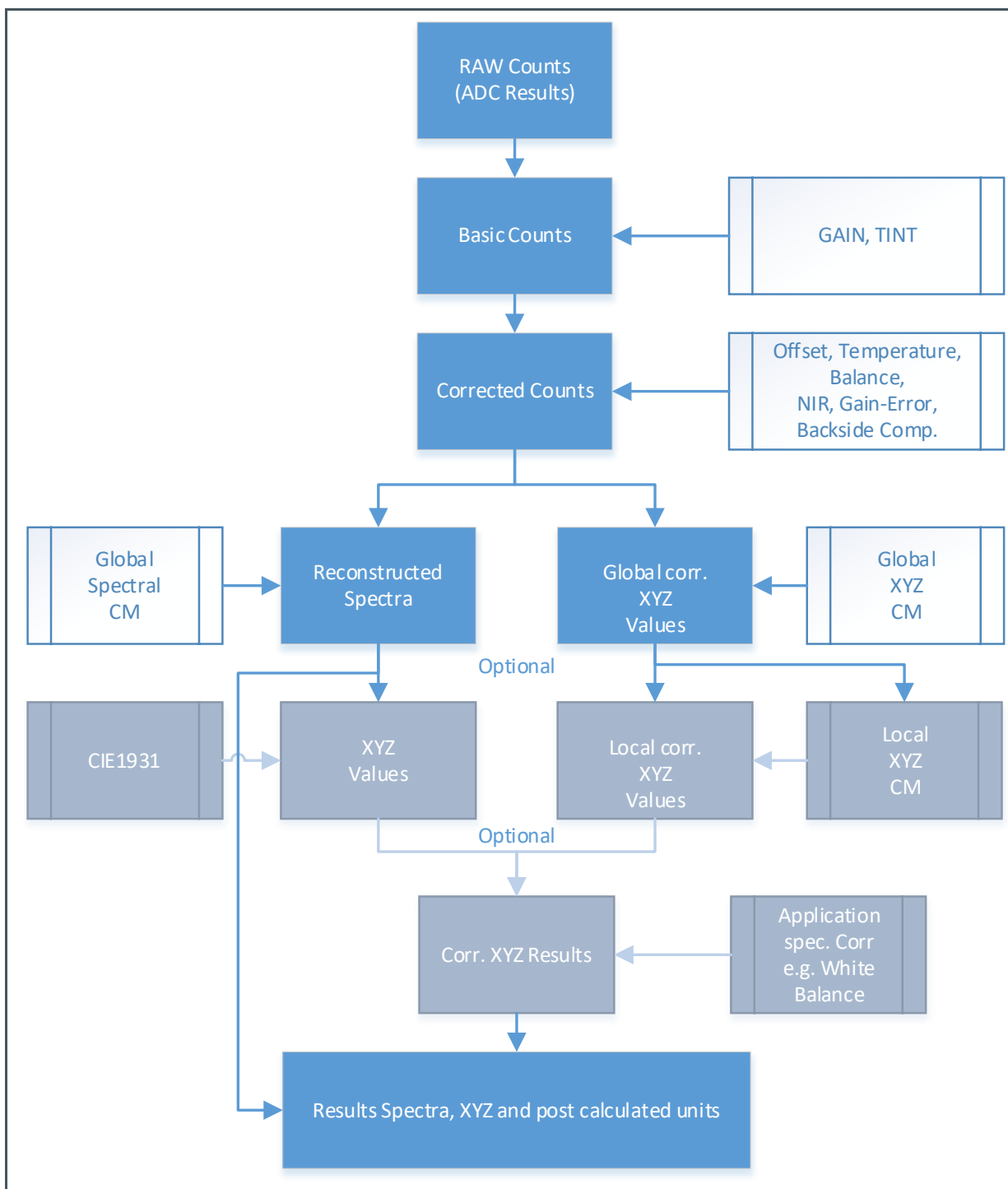
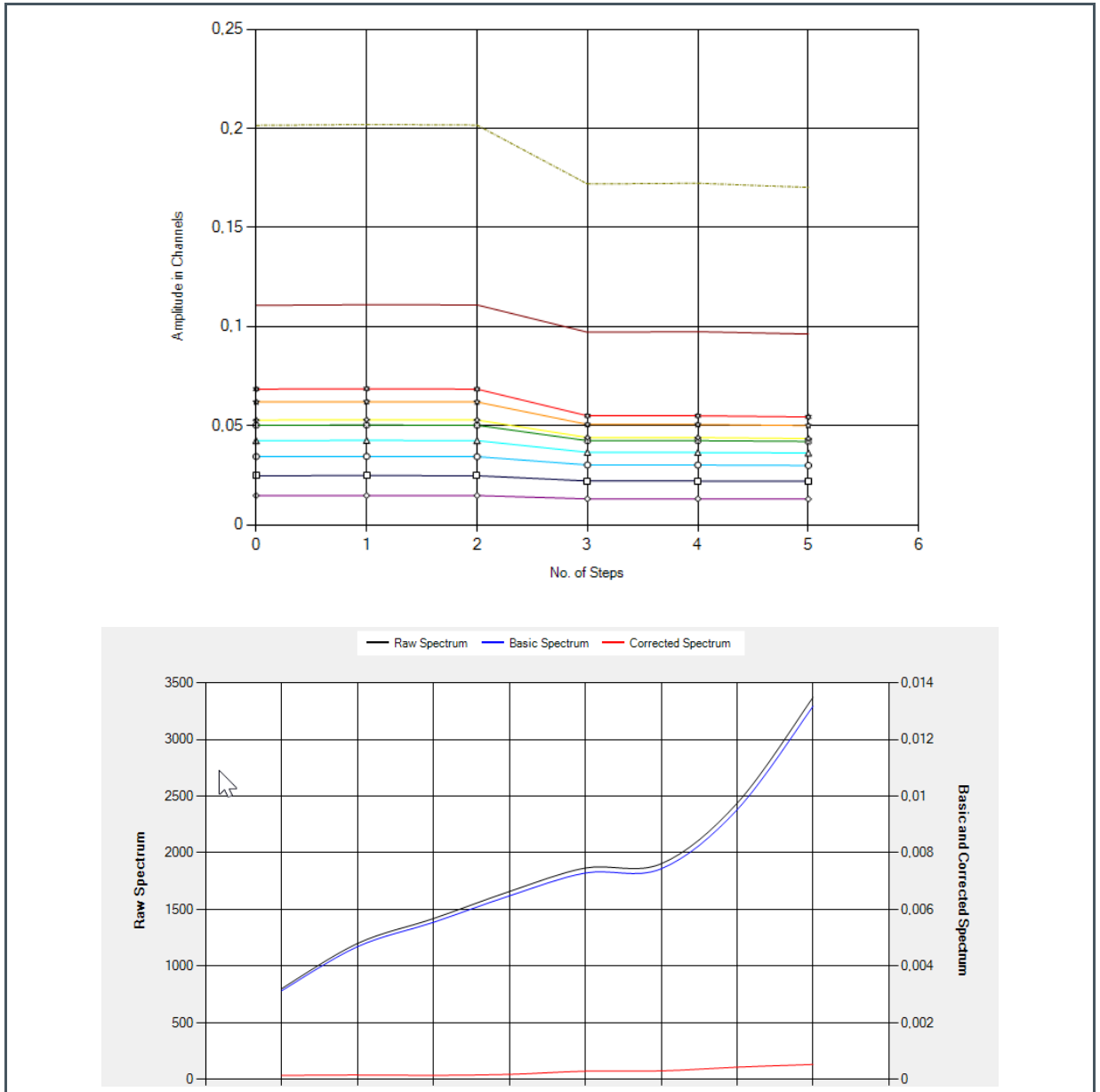


Figure 36:  
Sensor Results in a Line Diagram and as Raw-Spectra (Offset Reflection)<sup>(1)</sup>

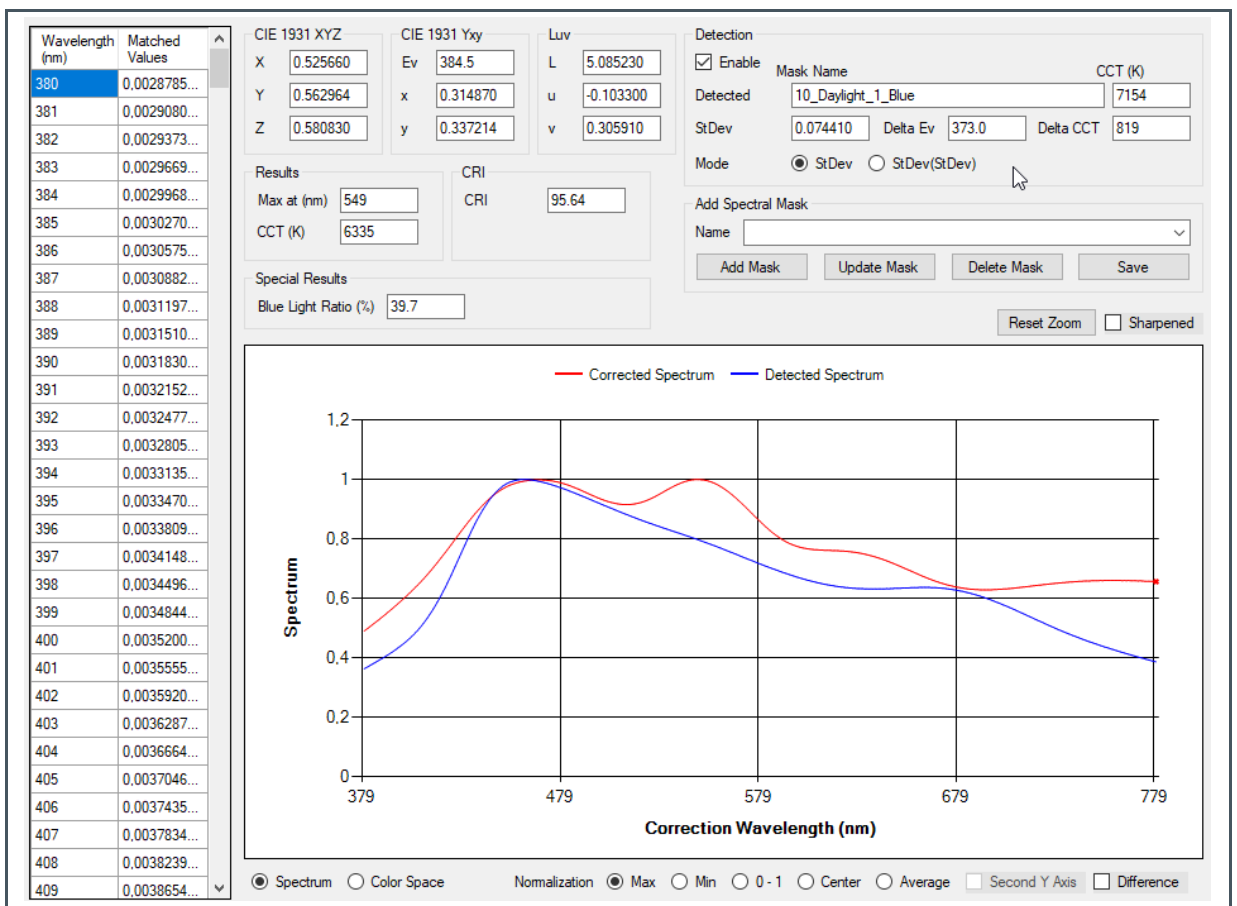


(1) Use 'Ctrl + left-mouse-click' to activate a magnifying glass in the diagram and enlarge a section in the spectra.

## 6.8 ALS Light Detection

ALS (Ambient Light Sensing), or Light Detection, identifies the type of light, max (peak), CCT, lx (Ev illumination intensity), CRI, and other spectral and color results, based on a reconstructed spectrum of sensor results (e.g. Blue Light Ratio). Clicking the 'Light/Display Detection' checkbox in the Main Tab and pressing 'Read Once' will open a new pop-up window. It shows the results as a vector, graphics (a spectrum as a list or diagram or xy-oriented color point in CIE1931 color space), calculated CIE1931 results<sup>14</sup>, and the detected light source from the Spectral Mask Compare if that function is enabled as a Detection. A calibration file is required to correct the raw sensor values and transfer them into a light spectrum. This spectrum is used to calculate the photometric CIE1931 color quantities.

**Figure 37:**  
Pop-Up Window of Light Detection by Spectral Light Comparison with Mask Detection Enabled



<sup>14</sup> The INIT, calibration, and correction files prepared for the GUI are not valid for all applications. Therefore, incorrect or deviating results may be possible. In practice, this means that the user has to check, adjust, and prepare for themselves the INIT and correction or calibration files for their application. Furthermore, all faults must be eliminated or taken into account in the setup. This usually shows formally incorrect results in red in the status window to indicate irregularities.

The function can only be used with a calibrated sensor for Light Detection, where the calibration matrix has been specially adapted to this application, and where Spectral Masks based on this calibration exists. Otherwise, the results may be inaccurate and illogical.

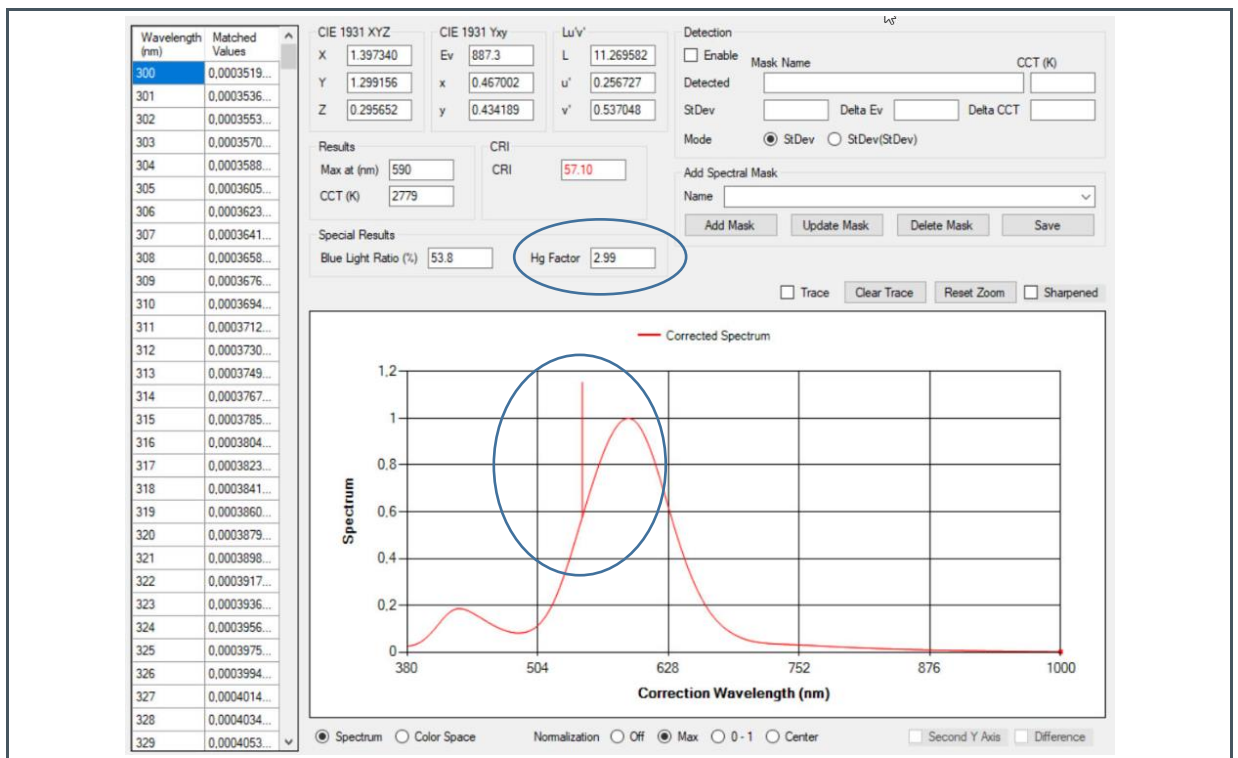
After opening the Light Detection, please start at a minimum of one measurement or more to activate and actualize all data and results in Light Detection.

The left-hand side of the pop-up window (Figure 38) shows the sensor results as a vector between wavelengths and reconstructed sensor results. The calibration file affects the wavelength dynamic (in the standard 'init' files from 380 nm up to 1000 nm) and step sizes (in the standard 'init' files 1nm step size). Data from the matrix in the reconstructed spectrum can be copied directly to another window using the copy/paste commands.

At the top of the pop-up window (Figure 38) are the results of all the CIE1931 calculations as CIE1931 Tristimulus values XYZ, xy coordinates, Y (Ev in Lux<sup>15</sup>), uv, CCT<sup>16</sup>, Peak, and CRI<sup>12</sup>. All these results, calculated standard values, and accuracy depend on the application, its conditions, deviations, calibration, parameters from init\_file(s), and other effects.

For more details, see chapter 6.1 or the application notes for the sensor calibration.

**Figure 38:**  
Using FY/F5 to Identify FL-Based Light Sources



<sup>15</sup> Only valid in the case of a calibrated sensor and depend on the specified parameter corr\_lux in the int\_file (see chapter 6.1.1).

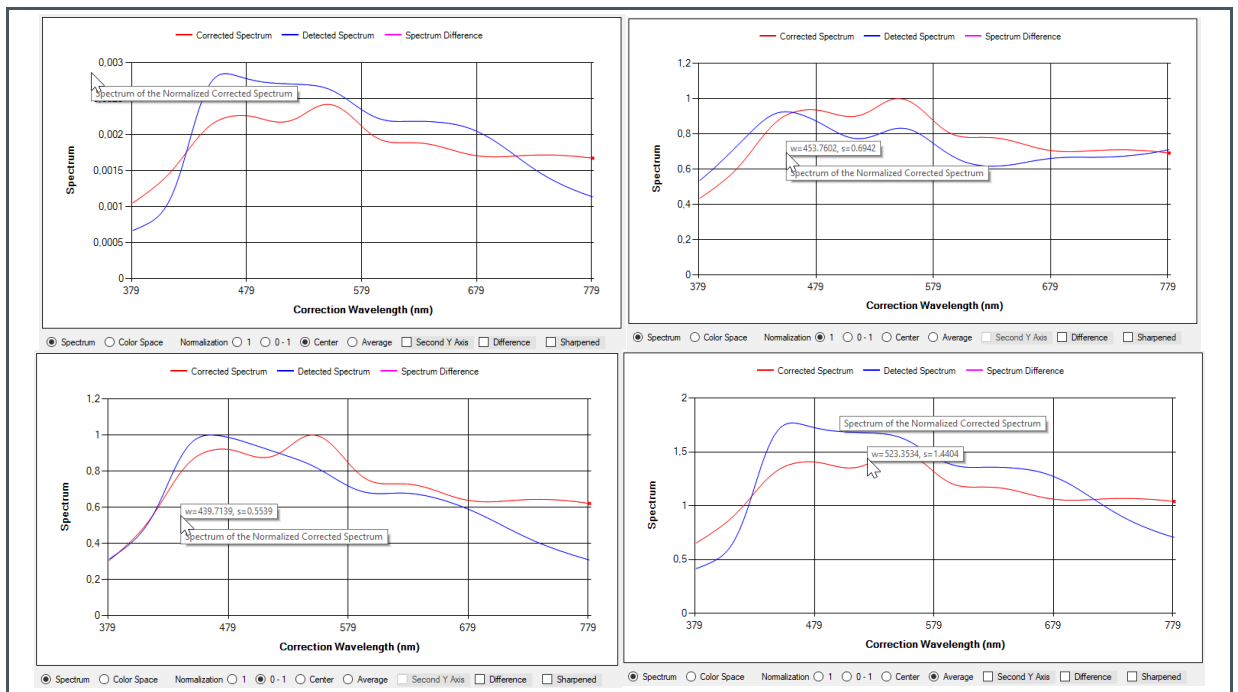
<sup>16</sup> See the status window in the basic window if the CRI value is printed in red.

Typical light source types can be classified e.g. into thermal sources such as (D50, D65, A, C), Fluorescent Lamp (FL), and LEDs (warm, neutral and cold white). Fluorescence lamps are specific because of their Hg+ bands (main at 435nm, 546nm and 610nm). The AS7343 includes a small additional banded spectra channel (F5) for identifying the FL based on 546nm peaks. F5 is completely covered by a wider filter, FY. It is therefore NOT used for sensor calibration, but the ratio of filters FY and F5 (**Hg+ Factor**) can be used to identify a FL-based light source with peak 546 nm. The GUI outputs the factor and displays the peak in the spectrum at 546nm in the case Hg < value. This value (typical = 3) can be set in the initialization file by using the 'Limit\_Hg\_Factor=' keyword (see chapter 6.1.1).

Another function of the GUI, besides spectral reconstruction and colorimetric quantities, is a function called Spectral MaskCompare, which is activated with Detection. Here, the spectra of light sources based on their spectral characteristics (course of the spectrum) are to be used for the identification of the light source. For this purpose, spectral light sources are agreed in a mask file by means of the spectrum and the name. This mask file is read when the function is switched on and can be edited or changed in the GUI beforehand.

If Light Detection is enabled, the GUI finds the nearest spectrum as masks, which is similar to the measured light and its reconstructed spectrum. The comparison works based on alternative normalization procedures ('Max, Min, 0-1, Center oriented or averaged'), which will affect the results dramatically. Normalization must be adapted based on the application and application-specific properties, and selected to get the best results.

**Figure 39:**  
**Normalization Method Affects the Mask Compare Process and Result**

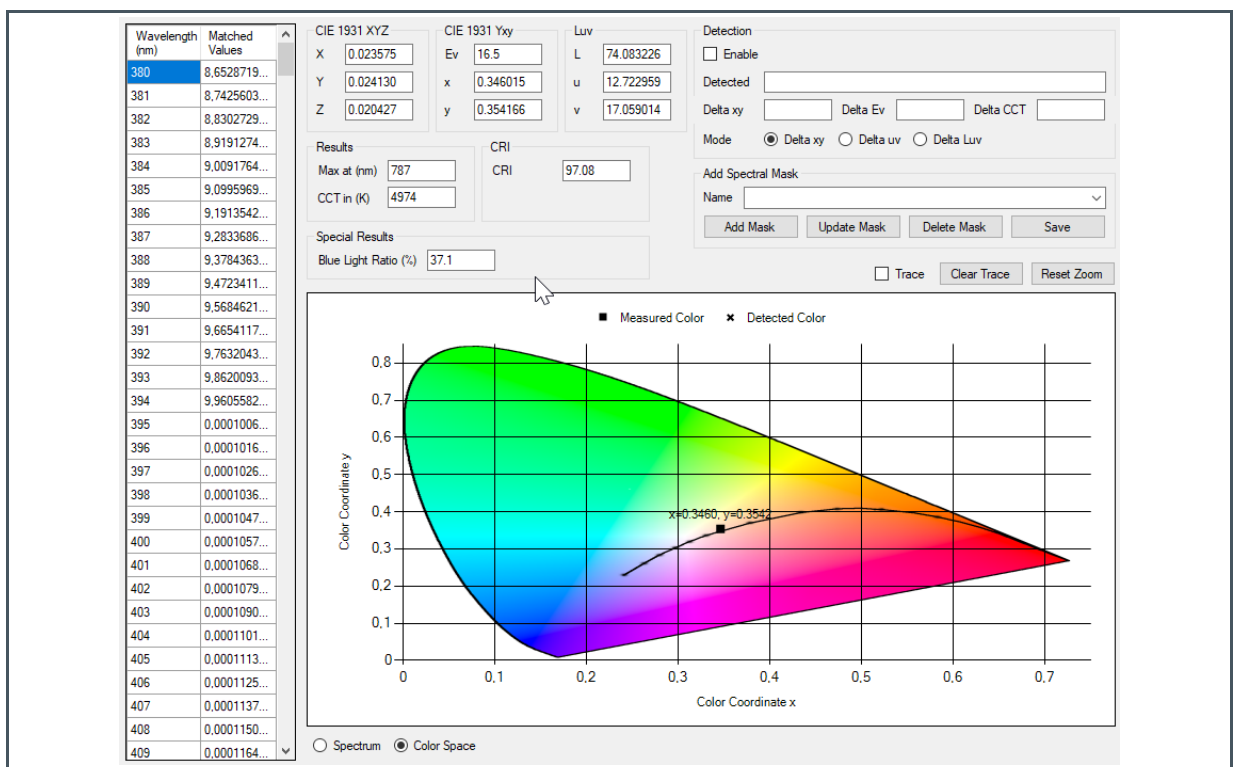




The spectral mask comparison uses the specified format from the calibration file (spectral data, XYZ) as a calculation basis for checking the differences between measured and normalized sensor results and masks. This means that the spectral error squares for spectrum, Delta E (or Dxy or Dab), or other values (selectable) and their standard deviation (or specific routines) are used to find the nearest mask.

Figure 37 shows the results from the sensor and its derived color and photometric quantities in numerical form and as a spectral diagram. Figure 40 shows the same result in the CIE1931 color space.

**Figure 40:**  
CIE1931 Color Space Diagram and Printed Results for the Light Detection



All the diagrams can be saved on a hard disk as a bitmap file by selecting the key combination 'Ctrl + Z'. Use a combination of Ctrl and the left mouse button to activate a temporary magnifying glass in the diagram.

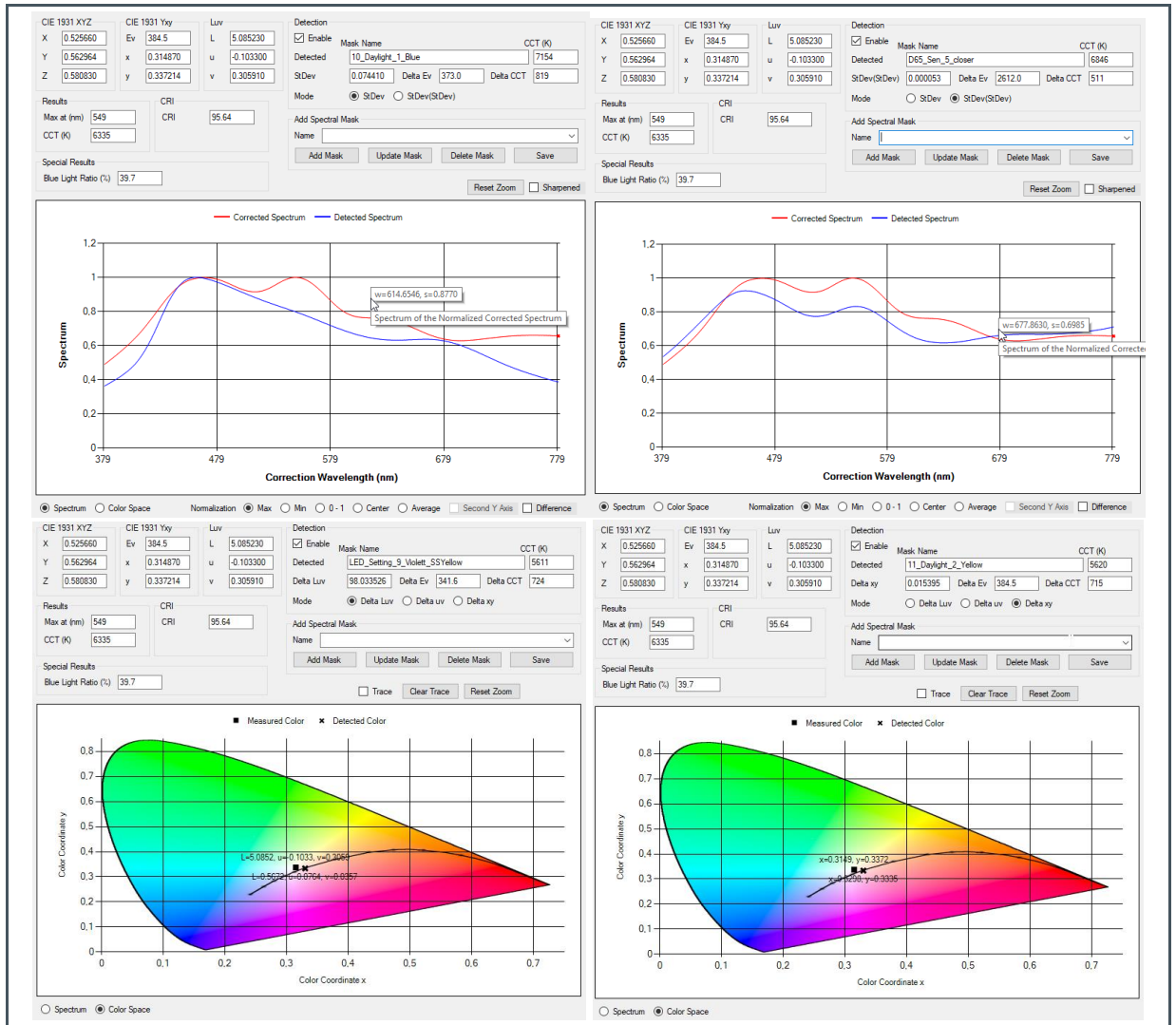
The activated 'Trace' button allows several measuring points in the diagram until deselecting the button or pressing the 'Clear Trace' button. Not selecting 'Trace' means only the most recent color coordinates are displayed as one color point in the diagram.

In general, the measured and recognized results will have deviations. Non-overlapping curves indicate such deviations. This is due to different conditions in the setup for measurements, spectral differences of light sources (measured and specified), and interferences by mixed lightings, tolerances, and drifts over time or shifts over temperature, different field of views, and others.

The more similar the types and samples of the light sources are between measurement and mask, and the smaller the deviations of the measurement conditions are, or the more adapted the algorithm is in the application, the better the result of the comparison will be.

Figure 41 shows examples of different results for the same measurement but using different algorithms for evaluation.

**Figure 41:**  
Example of Detection in Different Modes



In the left example from Figure 41, the mask with the smallest standard deviation over the full spectrum in the selected wavelengths is displayed as the result, i.e. the mask with the name '10\_Daylight\_1\_Blue' is spectrally closest to the measured and reconstructed light spectra. In the right example from Figure 41, the StDev (Standard Deviation) mode is selected, i.e. the mask with the smallest standard deviations between the CIE1931 wavelengths and their standard deviation for separated X, Y, and Z is selected as the result. This means the most similar spectrum, but with the

smallest differences between X, Y, and Z (affects the color temperature calculation), is considered and detected.

The evaluation in the CIE1931 color space is shown in the examples below and considers the modes Delta Luv and Delta xy. Thus, the mask is found as the result of the detection with the smallest distance in the Luv or xy color space, while spectral details are not considered. Therefore, a result of an 'LED adjustment' is possible even though the original light source was natural light.

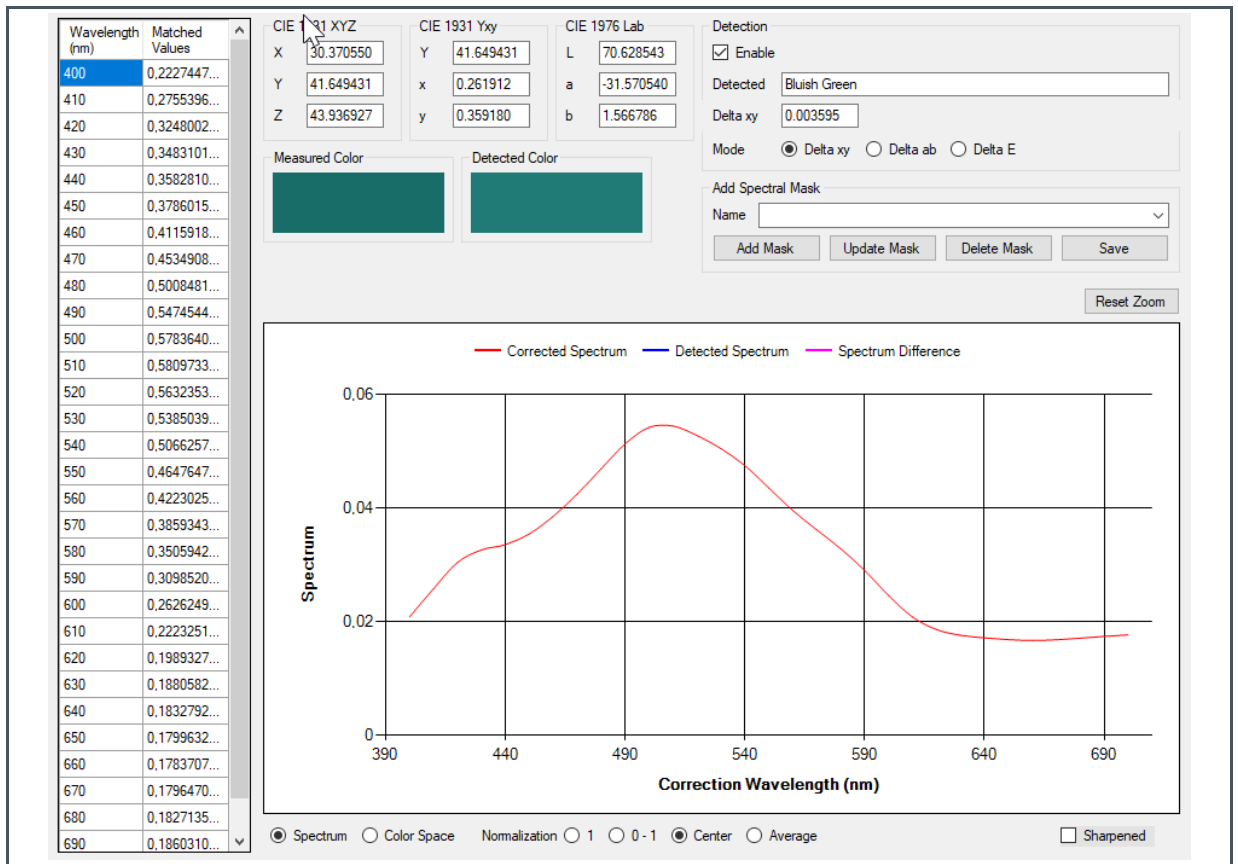
If the GUI does not identify a spectral mask within the given accuracy from the Init\_file, then the customer can specify a new spectral mask by pressing 'Add Mask'. This will add the spectrum of the measured light source (not normalized) as a new mask by a newly defined name. This new mask will be active temporarily and is active until the end of the program.

The mask will only be inserted into the mask file by using the Save button. The GUI will not check any duplicates in the mask file during all activities (read, add, save). Therefore, be careful and check names and masks before changing. The function, 'Light Detection', will not recognize a light source in the case of a non-existing mask file but works for the CIE1931 calculations.

## 6.9 Reflection Mode

The Reflection mode is prepared for measuring reflected light from colored surfaces in contact measurement based on the Evaluation Kit Reflection Mode (see Figure 2). After setting up all the parameters to get optimized counts, the function can be opened by selecting 'Reflection mode' in the section application-specific analysis: 'Reflection Mode'.

**Figure 42:**  
**Pop-Up Window of Reflection Mode with a Spectral Diagram and Detection (Spectral Calibrated)**



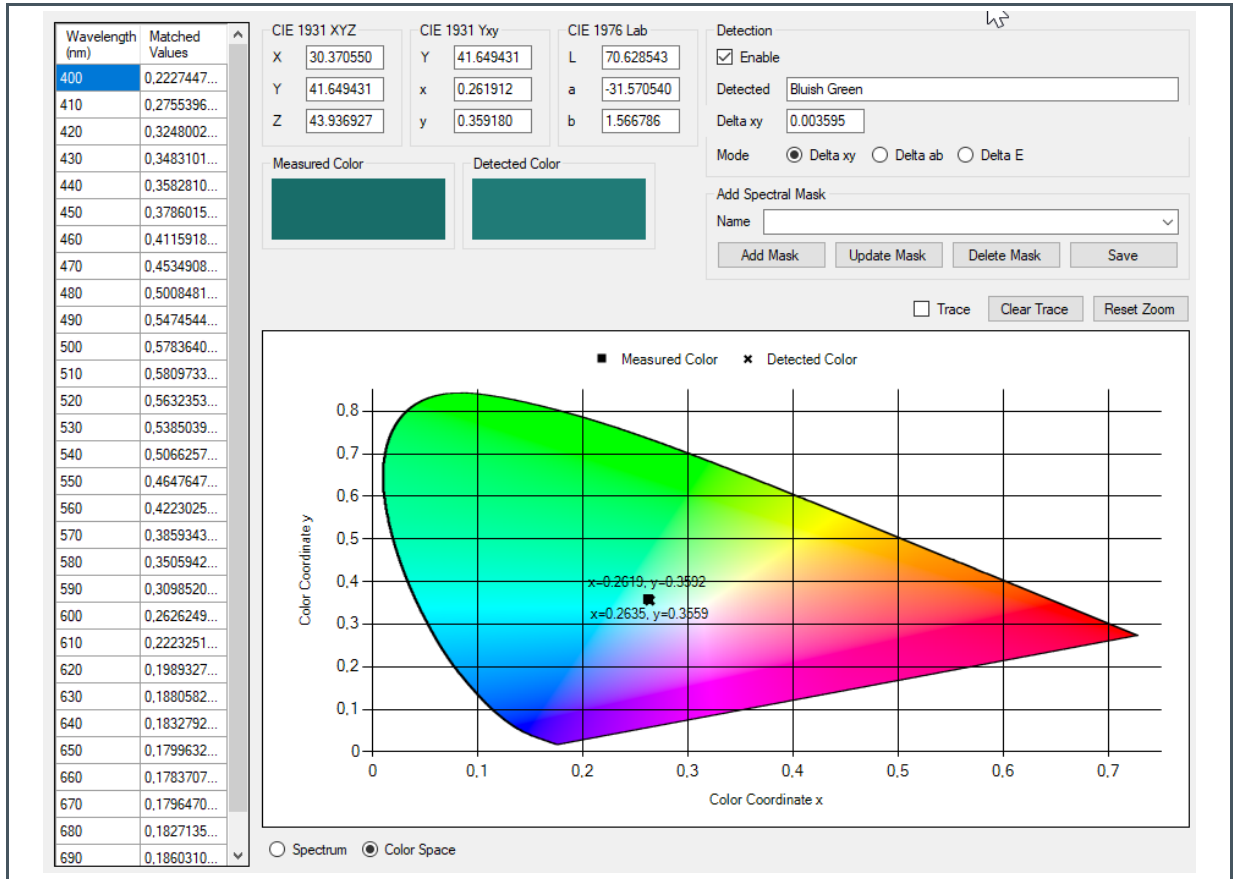
A new pop-up window will open, which shows based on the calibration of the spectrum, the CIE1931 calculated results XYZ<sup>17</sup>, xy, Lab as a numeric result and in the xy-diagram. Similar to light detection, after checking the checkbox for reflection, select the calibration files for reflection.

By default, the LED settings are enabled in flash mode with a default current of 110 mA. This function only uses wavelengths in the VIS range. Therefore, XYZ Tristimulus values are the basis for the

<sup>17</sup> The INIT, calibration, and correction files prepared for the GUI are not valid for all applications. Therefore, incorrect or deviating results may be possible. In practice, this means that the user has to check, adjust, and prepare the INIT and correction or calibration files for their application. Furthermore, all faults must be eliminated or taken into account in the setup. This usually shows formally incorrect results in red or west in the status window to indicate irregularities.

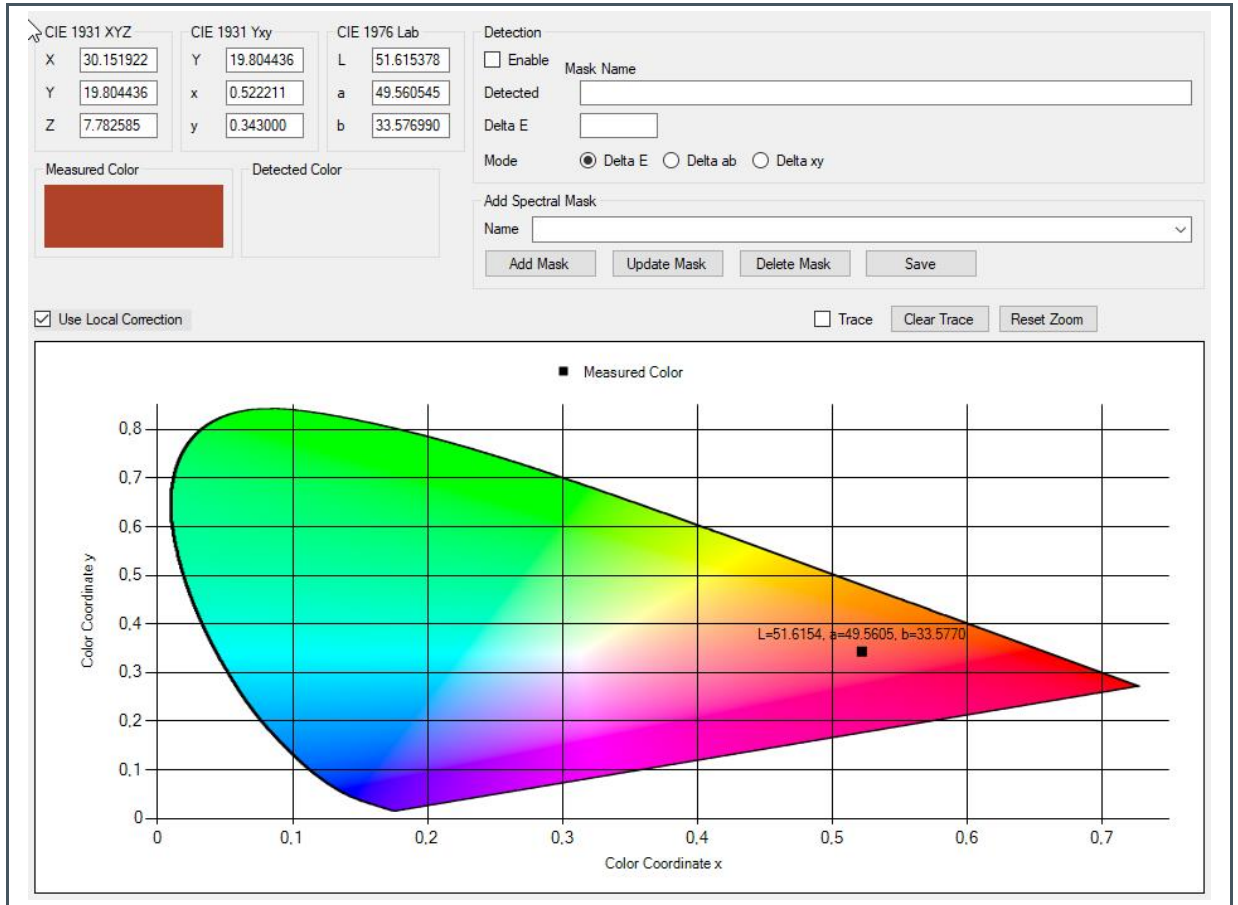
correction matrix and mask file for color recognition. Select between the diagrams in XYZ or as a reconstructed spectrum. Detection is always based on XYZ values.

**Figure 43:**  
**Pop-Up Window of the Reflection Mode with XYZ Diagram and Detection (Spectral Calibrated)**



After opening the Reflection mode, please start at the minimum, with one measurement to activate and actualize all the data and results in Reflection mode.

**Figure 44:**  
**Pop-Up Window of Reflection Mode with XYZ Diagram and Detection (XYZ for Local Calibration)**



When 'Backside Compensation' is selected, the GUI activates two consecutive measurements in 'Step' or 'Continuous' mode. The first measurement is performed without LED illumination, and the second measurement is with illumination. The results of the first measurement, in counts, are subtracted from the second measurement as background compensation<sup>18</sup>.

The GUI realizes the calibration depending on the calibration data from the calibration file. If the calibration file contains data for 'Local calibration', the local calibration can be switched on as a demo. In this case, global calibration is used to determine the approximate position of the measured value in the color space in the first step. Based on this position, a local and temporary correction matrix is calculated and used in step 2, with twelve targets closest to the estimated color position. In most cases, such a calibration leads to an improvement in the calibration results. For further details, see [6].

If 'Detection' is enabled, the GUI will show the recognized color from the mask file (point 1 of the xy-diagram), with the nearest distance (smallest Delta E or Delta ab or Delta xy) to the actual measured

<sup>18</sup> Offset compensation can be applied for constant ambient light. Use backside compensation for dynamic ambient light when backside compensation is recommended.

sensor value (point 2 in the xy-diagram). The 'Add Mask' button inserts a new mask in the mask file. This new mask will be temporarily active until the end of the program. The mask will only be inserted into the mask file by using the 'Save' button. Pressing the 'Update Mask' button will replace the existing reference mask values that are detected with the current measured values.

---

## 6.10 Window Log

The log file stores the sensor setup and data in a CSV data Excel format based on the window setup<sup>19</sup>. Click 'Start Logging' and/or 'Stop Logging' to select the samples, and close the process using 'Save Log' to store the CSV file and/or 'Clear Log' to delete the sampled log data. The title and content in the log files are different for ALS, light, and reflection measurements.

---

## 6.11 Flicker Log

The Flicker Log functions are identical to the menu Log functions. The only difference is that they only store the Hardware and FIFO Flicker data.

---

## 6.12 Detection Log

This is for Light and Reflection Detection logging. After enabling either Light or Reflection Detection, select 'Start' from the detection log window, or 'Ctrl+a' in the main tab, which will subsequently ask the user to save a CSV file. After each measurement, the user can save the light source by pressing 'Save' for each detection or 'Ctrl+s'.

A new pop-up window will ask the user to enter the name of the light source, and the user can select whether the light is detected or not.

---

## 6.13 Flicker Detection

Light sources may be modulated at different frequencies, as their power supply will cause them to flicker. Usually, light sources, such as fluorescent tubes or incandescent bulbs, flicker at frequencies proportional to their power supply. An AC flicker caused by an alternating current power supply varies at a frequency of 50 Hz or 60 Hz.

The sensor device has an integrated ambient light flicker detection on-chip.

In the GUI, two types of flicker detection methods are implemented – Hardware and FIFO methods, as shown in Figure 45 and Figure 46 (see also [3]). This window will pop up when clicking the Flicker

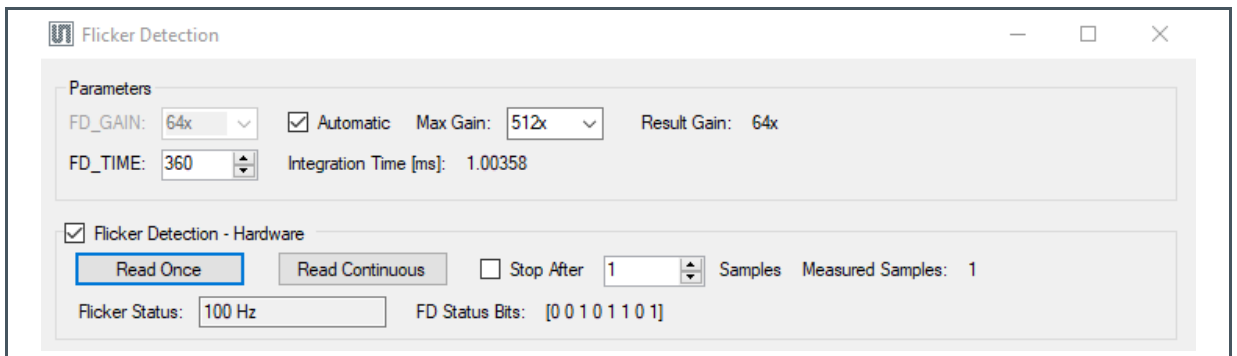
---

<sup>19</sup> It can result in issues in the notations (fixed-point, semicolon, and comma) in combination with wizards to convert text into numeric values and tables. Use a standard Window editor to replace the notations before processing with a wizard, in the case of such formatting issues.

detection in the Main Tab, which is disabled at the same time as the ALS measurements in the Main Tab. Selecting the 'Flicker Detection – Hardware' checkbox enables the hardware flicker detection and disables the FIFO method of flicker detection and vice versa.

The flicker detection with the standard EVK is limited, with up to approximately 1800 Hz flicker frequency. This is due to the limited frequency used by the I<sup>2</sup>C to USB interface. Therefore, another solution named EVK Fast Demo is recommended in the case of fast flicker measurements (see [7]).

**Figure 45:**  
**Flicker Detection – Hardware**



By default, 'Flicker Detection – Hardware' is selected. The hardware flicker detection detects the presence of 100 Hz and 120 Hz flickering. The 'Read Once' button displays the status of the flicker in the 'Flicker Status'. The corresponding bit in the FD status register is shown as 'FD Status Bits'. Clicking the 'Read Continuous' button will keep updating the FD samples. If the 'Stop After' checkbox is selected, and the number of samples is mentioned, the mentioned samples will be measured upon pressing the 'Read Continuous' button. The samples taken show the number of finished measurements.

On the other hand, the FIFO method of flicker detection is selected and flicker detection, default integration time, gain, and threshold are configured. Use the parameters gain and integration time to adapt the measurement to application-specific requirements by unchecking the Automatic checkbox.

The 'FD Integration time' can be set by clicking the up-down arrow or by setting a value and pressing enter. The respective Integration time is calculated based on the formula  $(Fd\_time + 1) * 2.78$  and displayed in milliseconds. The 'FD Gain' can be picked by choosing one of the values from the selection list: 0.5x ... 5120x. Similarly, FD Threshold can be selected as 1, 4, 8, and 16. 'FD Time' and 'FD Gain' define the sampling rate, amplitude of counts, and the maximum number of counts.

Click the 'Read Once' button to update the Flicker detection graph with the current samples of the FIFO data in bytes. The output of the flicker channel in counts (raw data) is plotted against the corresponding sample and the number in the primary Y-axis (left) and X-axis respectively (bottom), in red on the colored graph.

Clicking the 'Read Continuous' button will keep updating the FD samples. If the 'Stop After' checkbox is selected, and the number of samples is mentioned, the mentioned samples will start to be measured after pressing the 'Read Continuous' button.



The taken phrase samples show the number of finished measurements. In a single cycle, FIFO\_Lvl samples give the maximum number of FIFO entries (every 2 bytes), read-out either before the overflow flag goes high, or before the maximum sample taken is less than 250.

The sample levels are added up on consecutive measurements. Sampling Frequency is the reciprocal of the Flickering Integration time. The maximum detectable frequency is half of the sampling frequency. The maximum detectable frequency and the detected flicker frequency are shown below the graph.

The 'FD Saturation' flags show the status of the saturation flag bit like FIFO overflow, FD trigger, FDSat\_Analog, and FDSat\_Digital. At a lower FD\_TIME, the chance of getting FIFO overflow is more.

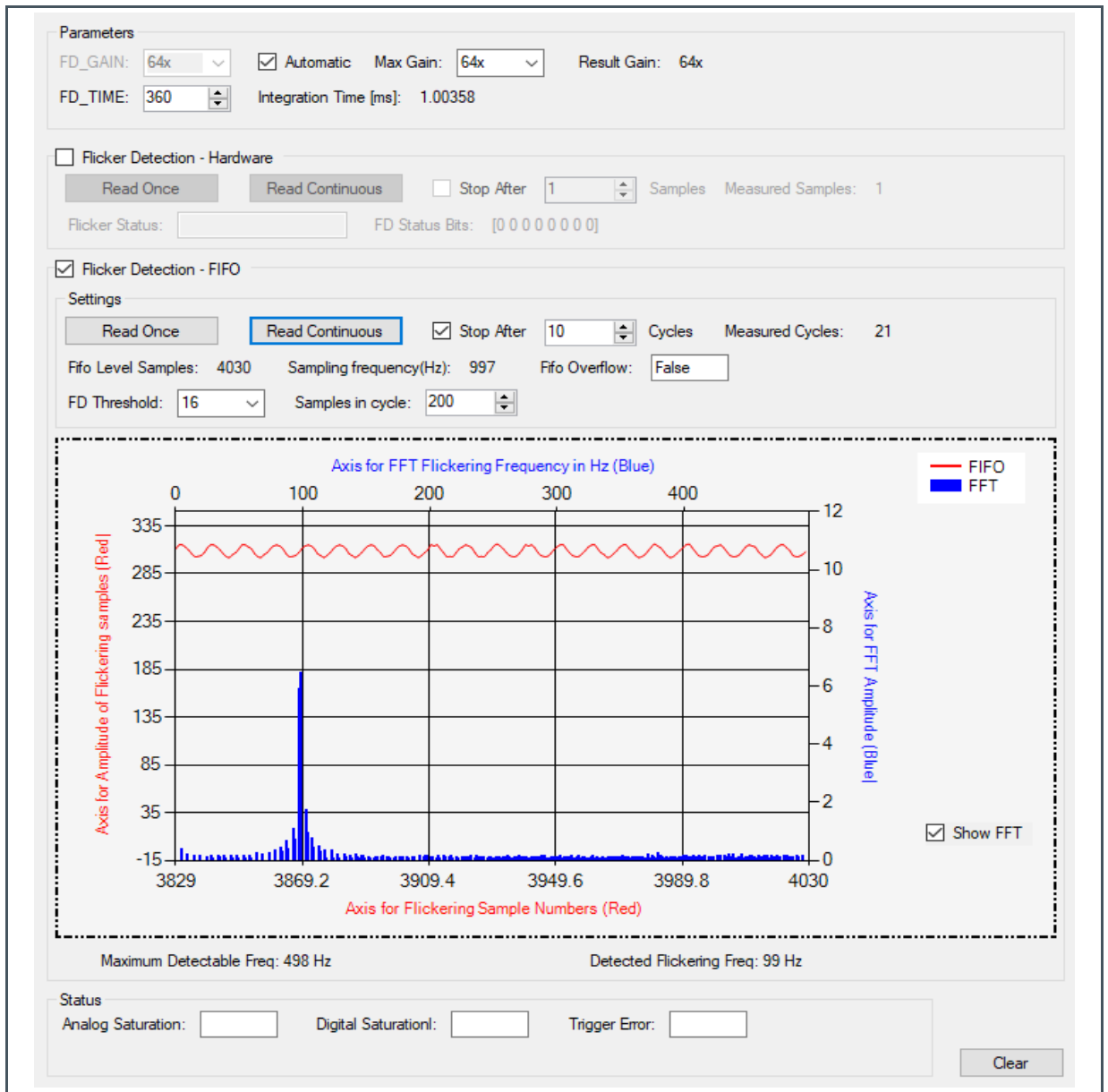
Fourier analysis converts a signal from its original domain (often used) to a representation in the frequency domain. Selecting the FFT checkbox computes the Fast Fourier Transformation and enumerates the discrete results graphically.

The FFT plot is represented in blue, with the amplitude of FFT in the secondary Y-axis (top) and the frequency shown in the secondary X-axis (right). Figure 46 shows the results of an example. The frequency line with the highest amplitude is represented as the result of the detected flickering frequency (99 Hz in the example).

If more than one frequency is shown in a diagram with similar maximal amplitudes, then more than one flicker frequency is detected as potential results. It means the sensor results may be noisy; the counts are too low, and the transitions are not clean enough. Hence, the flicker frequency is not assignable.

The 'Clear' button clears out the last measurement data and plot.

Figure 46:  
Flicker Detection - FIFO



## 6.14 Register Mapping

The Register Table window lists and allows the writing of all the I<sup>2</sup>C registers values with the address, the name, and information about authorization to read or write.

**Figure 47:**  
Register Mapping Table

Register Address	Name	b7	b6	b5	b4	b3	b2	b1	b0	Current Value
0x01	OTP_MEM_1	0	0	0	0	0	0	0	0	0x00
0x0b	OTP_MEM_B	0	0	0	0	0	0	0	0	0x00
0x0c	OTP_MEM_C	0	0	0	0	0	0	0	0	0x00
0x0d	OTP_MEM_D	1	0	0	1	0	0	1	1	0x93
0x0e	OTP_MEM_E	0	1	0	1	0	0	0	0	0x50
0x0f	OTP_MEM_F	0	1	1	0	0	0	0	0	0x60
0x58	AUXID	0	0	0	0	0	0	0	0	0x00
0x59	REVID	0	0	0	0	0	0	0	0	0x00
0x5a	ID	0	0	0	0	0	0	0	1	0x01
0x65	CFG10	1	1	1	1	0	0	1	0	0xf2
0x80	ENABLE	0	0	0	0	0	0	0	1	0x01
0x81	ATIME	0	0	0	0	0	0	0	0	0x00
0x83	WTIME	0	0	0	0	0	0	0	0	0x00
0x90	STATUS2	0	0	0	0	0	0	0	0	0x00
0x92	STATUS6	0	0	0	0	0	0	0	0	0x00
0x93	STATUS	0	0	0	0	0	0	0	0	0x00
0x94	ASTATUS	0	0	0	0	0	0	0	0	0x00
0x95	CH0_DATA_L	0	0	0	0	0	0	0	0	0x00
0xbf	CFG0	0	0	0	0	0	0	0	0	0x00
0xc6	CFG1	0	0	0	0	1	0	0	1	0x09
0xc9	CFG8	1	0	0	0	0	0	0	0	0x80
0xcd	LED	0	0	0	0	0	1	0	0	0x04
0xd4	ASTEP_L	1	0	1	1	1	0	1	1	0xbb
0xd5	ASTEP_H	1	1	1	1	1	1	1	1	0xff
0xd6	CFG20	0	1	1	0	0	0	0	0	0x60
0xd7	AGC_GAIN_MAX	1	0	0	1	1	0	0	1	0x99
0xde	AZ_CONFIG	1	1	1	1	1	1	1	1	0xff
0xdf	FD_CFG0	0	0	1	0	0	0	0	1	0x21
0xe0	FD_TIME1	0	1	1	0	0	1	1	1	0x67

Click the ‘Read values’ from the sensor button to update the entire table. It is recommended to update the table when using or leaving this window. Write a value to a register by clicking the ‘Current Value’ cell that corresponds to the register and typing a new value into the cell. The value will only be saved temporarily in the window. Use the ‘Save register table’ to make an external copy of all the registers and the values into a CSV file.



### Information

The application synchronizes the changes in the Main Tab and the Register Table page automatically.

## 6.15 Tracer

The Tracer controls the software process by using pre-designed scripts in TXT format. Such scripts can be loaded, saved, proceeded, or cleared. 'Log' is a protocol function that can be saved or cleared. Figure 49 shows the window tracer with an example code for a pre-designed script with 'log'.

The following commands are implemented in the actual Tracer function:

**Figure 48:**  
**List of Tracer Commands and Examples<sup>(1)</sup>**

Tracer Command Syntax	Function Explanation	Usage Example
AutoGain <on, off> <sup>(2)</sup>	Switch on/off autogain	autoGain on autoGain off
AutoTint <on, off> <sup>(3)</sup>	Switch on/off autoint	autoTint on autoTint off
BackSideComp <on, off>	Switch on/off BackSideCompensation	BackSideComp off
BeginLoop <n> .... EndLoop	The actions between BeginLoop and EndLoop will be done by the GUI n-times as specified.	BeginLoop 3 Readsamples 5 Pause 1000 EndLoop
Clearlog	Clear the measured sample log.	Clearlog
Gain <Value>	To set Gain < 0.5x, 1x, 2x, 4x, 8x, 16x, 32x, 64x, 128x, 256x, 512x >.	Gain 256
Inttime <Atime><Astep>	To set Integration time, Atime <0 - 255> and Astep <1 - 65534>.	Inttime 0 60000
Ledon <Value> <flash>	To enable LED with a current <0-127> with/without flash mode.	Ledon 50 flash
Ledoff	To disable the LED and LED current to the default value.	Ledoff
Mode <clear> <nir>	To enable or disable NIR and VIS mode <clear> <nir> : < 0, 1 > < 0, 1 >.	Mode 0 0
OpenDialogAls	Open ALS Function.	openDialogAls
Openlog	Open log file.	Openlog
Pause <value in ms>	To set a delay in ms.	Pause 100
Readsamples <>	Samples measured continuously for the value times.	Readsamples 5
Readtime < time in seconds>	Read continuous measurement for given seconds.	Readtime 10
R < Register Addr>	To read out the specified register.	R 80
Savelog	Saves the measured samples to a CSV file.	Savelog

Tracer Command Syntax	Function Explanation	Usage Example
SaveOffset	Take over the last measured sensor results as a new Offset.	SaveOffset
SaveInitData	Save all the correction values (e.g. offset and white balance) to disk and/or EEPROM.	SaveInitData
SetComment 'txt'	Txt will be copied into the logfile as a comment for the actual measurement.	SetComment 'DarlTest'
ShowMessage 'txt'	Print out 'txt' on the screen until the user confirms message with <ok>.	showMessage 'This is a message'
SaveWhiteBalance	Take over the last measured sensor results as White <sup>(4)</sup> .	SaveWhiteBalance
StartLog	Start logging.	StartLog
StopLog	Stop logging.	StopLog
W < Register Addr ><Value>	To write mentioned value to a specified register.	W 80 01
WriteLine "	Write the 'Text' on display.	writeLine 'This is a line of text'
#	To comment out a line in a tracer script.	# comment
<b>Only useful if it will be supported from the hardware.</b>		
LedWhite60 <On/Off>	Followed by 'ledon' command.	
LedWhite120 <On/Off>	Followed by 'ledon' command.	
LedNir60 <On/Off>	Followed by 'ledon' command.	
LedNir120 <On/Off>	Followed by 'ledon' command.	
Ledleft <On/Off>	Followed by 'ledon' command.	
LedTop <On/Off>	Followed by 'ledon' command.	
LedBottom <On/Off>	Followed by 'ledon' command.	

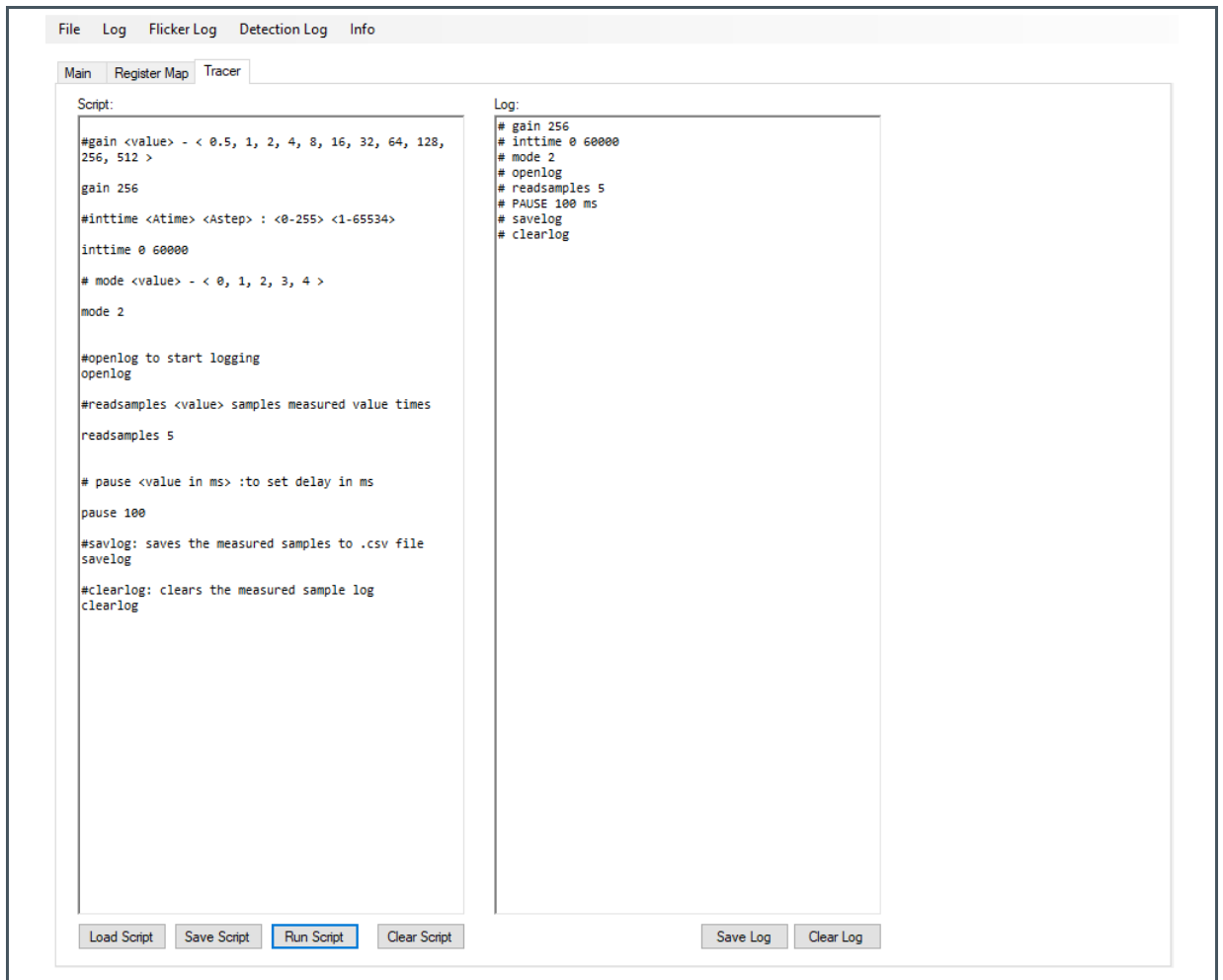
- (1) Always see the AS7343\_script.TXT file for the newest tracer commands and examples.
- (2) Necessary for initialization = 'off' if gain setting will be used in tracer file.
- (3) Necessary as initialization = 'off' if Tint setting will be used in tracer file.
- (4) Needs WhiteReferenceValues in the Correction Matrix File – only valid in reflection mode.



### Information

The register address and register value are always specified as hexadecimal numbers without 0x. Comments are directly behind a command or in a new line. The upper and lower case is neglected.

**Figure 49:**  
**Tracer with an Example in Script and Log Tab**



Some examples of tracer files are in the data directory after installing the GUI software.

## 7 Error Message List

Figure 50:  
Error Message List

Error Message	Explanation
<p>Error during the connection of the device: An error occurred during connecting the FTDI device. An error occurred during scanning for FTDI devices.</p>	<p>Check the FTDI connection and correct FTDI cable version (3.3V or 5V) between the sensor and the USB port, and ensure that the FTDI cable or sensor are not faulty. UNICOM interface board can be used alternatively as sensor board interface to USB and PC.</p>
<p>Analog Saturation: Intensity of ambient light has exceeded the max INT level for the spectral analog circuit.</p>	<p>Indicates analog saturation. Reduce the light intensity, Integration time, or Gain to overcome the saturation.</p>
<p>Digital Saturation: The maximum counter value has been reached.</p>	<p>Indicates digital saturation. Reduce the light intensity, integration time, or Gain to overcome the saturation. The maximum value range 65635 is reached.</p>
<p>Digital and analog saturation has been reached.</p>	<p>Indicates both digital and analog saturation is reached. Reduce the light intensity, integration time, or Gain to overcome the saturation.</p>
<p>Status SP_TRIG Error: WTIME is too short for the selected TINT</p>	<p>Spectral Trigger Error: Indicates that there is a timing error. WTIME is too short for the selected ATIME. Increase the WTIME to overcome this issue.</p>
<p>Error during reading the register value.</p>	<p>This means an error occurred while reading the register value from the sensor.</p>
<p>Error during setting power on.</p>	<p>Error occurred. Set the PON bit in the Enable register (0x80). Disconnect the device and try again.</p>
<p>Error during enabling or disabling the spectral measurement.</p>	<p>Error during enabling or disabling the spectral measurement. Enable bit in Enable register (0x80).</p>
<p>An error occurred during enabling or disabling external LED.</p>	<p>Setting the LED current produces an error.</p>
<p>Status Over Temperature Detected: Device temperature is too high.</p>	<p>Over temperature detected. The device temperature is too high.</p>
<p>Cannot detect the optimal gain. Please change the settings.</p>	<p>The optimal gain was out of range. Change the settings for an optimal gain.</p>
<p>Unequal number of correction factor in Init_file.txt</p>	<p>The number entered for the correction factor should be crosschecked in the 'Init_file'.</p>

Error Message	Explanation
Error reading light detection light source matrix file:<file location > Input string was not in a correct format	Crosscheck the corresponding file data. The data entered may not be in the correct format or there may be mismatching in the index.
File opened error	Another process opens the log file where the data is saved. Do not open the file between the measurement logging.
The Init_file was not found	Ensure that the Init_file is in the directory or with the correct name, where the software files are installed, as mentioned in chapter 6.1.
Error opening the Init_file	Ensure that the Init_file is closed while operating the GUI. The changes made to the Init_file should be saved and the software should be reopened to see the effect of the changes.
Error reading the Init_file	When the parameters in the Init_file are not correctly named, no value is provided for a parameter, commented out, or not in the correct format and dimension. The corresponding parameter is selected from the default values. The status box will display this information with a blue status message.
Error opening <filename><file location> because it is used by another process	File not found or save the changes made to the file and close it. In order to see the effects of the change, close and reopen the GUI. Do not open the file while the software is running.
Measured color coordinate out of range	Error in the calibration, correction, or measurement. The measured sensor results are not valid in the CIE1931 Color space. Check the setup, init_files and the calibration.
CCT out of range	Occurs during light detection, if the CCT calculated is out of the range from the value defined in 'Init_file.txt'.
Calculated delta uv greater than given delta uv	Occurs during light detection, if the delta uv calculated is greater than the given delta uv in the 'Init_file.txt'.
u and v not in limit	Occurs during light detection, if the u and v calculated is not in the limit, which is in the 'Init_file.txt'.
An error occurred during enabling or disabling flicker detection	Error occurred during the Fden bit in the Enable register (0x80).
No samples were logged	Take measurements for the process or save data to a log file.
An overflow detected. Data has been lost in continuous measurement	Warning - An overflow detected. Data has been lost in a continuous measurement.
Mask number is too big or maximum number of mask entries reached	While writing the mask files to the EEPROM, the maximum limit of the entry is reached.



Error Message	Explanation
Mask file contains wavelength that are not in calibration matrix file	A warning of unequal wavelength. The mask compare could be used even though they have different wavelengths. However, each will overwrite the old mask file with the new wavelength entry.
Header Item: Wavelength or title was not found	In the calibration file, wavelength is considered as the starting point for the calibration matrix. Title is considered as the starting point for the reference file. If these are wrongly typed, the GUI generates an error.
Unexpected line detected	When calibration or reference files do not have the expected number of values or error in the entry format. An empty matrix is considered in this case.

---

## 8 Additional Documents

---

The following list includes a selection of the available documents with additional technical details for the AS7343 sensor and its Evaluation Kit. This list is not fixed and it is constantly changing. Ask us for new details.



**For further information, please refer to the following documents:**

1. ams-OSRAM AG, AS7343 14-Channel Spectral Sensor, datasheet.
  2. ams-OSRAM AG, *AS7343 Details for Opto-Mechanical Design*, application note.
  3. ams-OSRAM AG, *AS7341 Eval Kit Flicker Detection (AN000605)*, application note.
  4. ams-OSRAM AG, *SMUX configuration (AN000666)*, application note.
  5. ams-OSRAM AG, *a0013a\_CSS Evalboard AS7343*.
  6. ams-OSRAM AG, *AS7341 Eval Kit –Spectral Balance and Calibration (QG000139)*, quick start guide.
  7. ams-OSRAM AG, *AS7341 Demo for Fast Measurement Using Unicom Board (AN000660)*, application note.
-

---

## 9 Revision Information

---

Changes from previous version to current revision v2-00	Page
Removed all instances of AS7352 throughout the document	all
Unnecessary FTDI driver installation under Windows 10	9
New Commands in Tracer (Loop, BackSideComp, ...)	51
Error Message List	26, 54

---

- Page and figure numbers for the previous version may differ from page and figure numbers in the current revision.
- Correction of typographical errors is not explicitly mentioned.

# 10 Legal Information

## Copyrights & Disclaimer

Copyright ams-OSRAM AG, Tobelbader Strasse 30, 8141 Premstaetten, Austria-Europe. Trademarks Registered. All rights reserved. The material herein may not be reproduced, adapted, merged, translated, stored, or used without the prior written consent of the copyright owner.

Demo Kits, Evaluation Kits and Reference Designs are provided to recipient on an "as is" basis for demonstration and evaluation purposes only and are not considered to be finished end-products intended and fit for general consumer use, commercial applications and applications with special requirements such as but not limited to medical equipment or automotive applications. Demo Kits, Evaluation Kits and Reference Designs have not been tested for compliance with electromagnetic compatibility (EMC) standards and directives, unless otherwise specified. Demo Kits, Evaluation Kits and Reference Designs shall be used by qualified personnel only.

ams-OSRAM AG reserves the right to change functionality and price of Demo Kits, Evaluation Kits and Reference Designs at any time and without notice.

Any express or implied warranties, including, but not limited to the implied warranties of merchantability and fitness for a particular purpose are disclaimed. Any claims and demands and any direct, indirect, incidental, special, exemplary or consequential damages arising from the inadequacy of the provided Demo Kits, Evaluation Kits and Reference Designs or incurred losses of any kind (e.g. loss of use, data or profits or business interruption however caused) as a consequence of their use are excluded.

ams-OSRAM AG shall not be liable to recipient or any third party for any damages, including but not limited to personal injury, property damage, loss of profits, loss of use, interruption of business or indirect, special, incidental or consequential damages, of any kind, in connection with or arising out of the furnishing, performance or use of the technical data herein. No obligation or liability to recipient or any third party shall arise or flow out of ams-OSRAM AG rendering of technical or other services.

## RoHS Compliant & ams Green Statement

**RoHS Compliant:** The term RoHS compliant means that ams-OSRAM AG products fully comply with current RoHS directives. Our semiconductor products do not contain any chemicals for all 6 substance categories plus additional 4 substance categories (per amendment EU 2015/863), including the requirement that lead not exceed 0.1% by weight in homogeneous materials. Where designed to be soldered at high temperatures, RoHS compliant products are suitable for use in specified lead-free processes.

**ams Green (RoHS compliant and no Sb/Br/Cl):** ams Green defines that in addition to RoHS compliance, our products are free of Bromine (Br) and Antimony (Sb) based flame retardants (Br or Sb do not exceed 0.1% by weight in homogeneous material) and do not contain Chlorine (Cl not exceed 0.1% by weight in homogeneous material).

**Important Information:** The information provided in this statement represents ams-OSRAM AG knowledge and belief as of the date that it is provided. ams-OSRAM AG bases its knowledge and belief on information provided by third parties, and makes no representation or warranty as to the accuracy of such information. Efforts are underway to better integrate information from third parties. ams-OSRAM AG has taken and continues to take reasonable steps to provide representative and accurate information but may not have conducted destructive testing or chemical analysis on incoming materials and chemicals. ams-OSRAM AG and ams-OSRAM AG suppliers consider certain information to be proprietary, and thus CAS numbers and other limited information may not be available for release.

### Headquarters

ams-OSRAM AG  
Tobelbader Strasse 30  
8141 Premstaetten  
Austria, Europe  
Tel: +43 (0) 3136 500 0

Please visit our website at [www.ams.com](http://www.ams.com)

Buy our products or get free samples online at [www.ams.com/Products](http://www.ams.com/Products)

Technical Support is available at [www.ams.com/Technical-Support](http://www.ams.com/Technical-Support)

Provide feedback about this document at [www.ams.com/Document-Feedback](http://www.ams.com/Document-Feedback)

For sales offices, distributors and representatives go to [www.ams.com/Contact](http://www.ams.com/Contact)

For further information and requests, e-mail us at [ams\\_sales@ams.com](mailto:ams_sales@ams.com)