

THIS IS A C.A.D. GENERATED DRAWING  
DO NOT MAKE MANUAL REVISIONS TO MASTER.

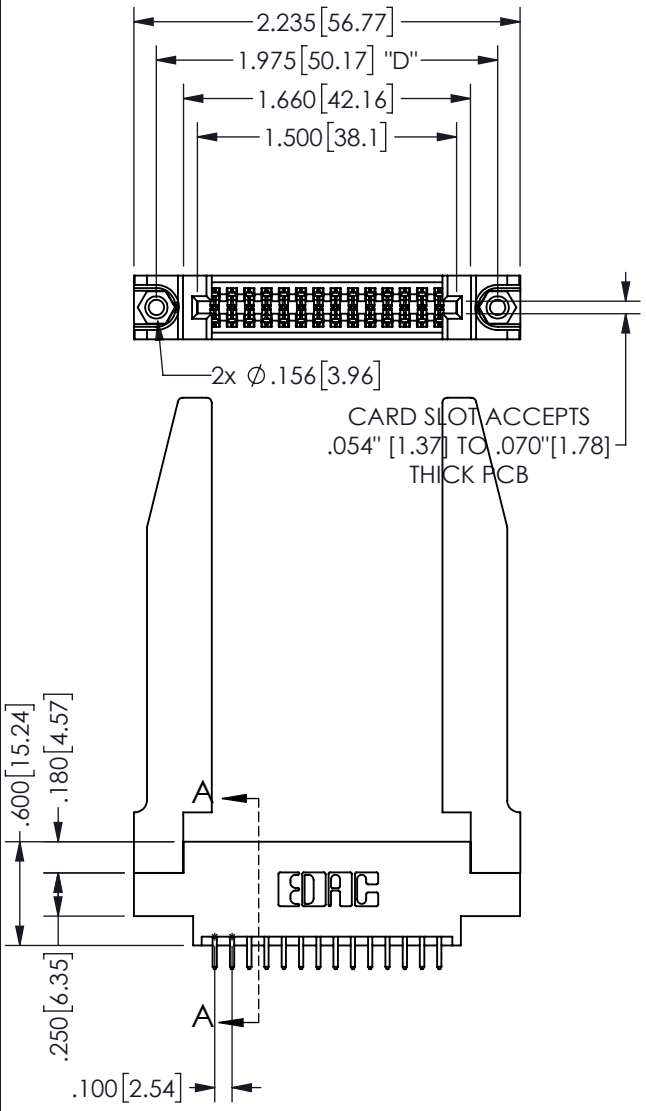

ISSUE NUMBER	
ORIGINAL	①



CARD SLOT ACCEPTS  
.054" [1.37] TO .070" [1.78]  
THICK PCB

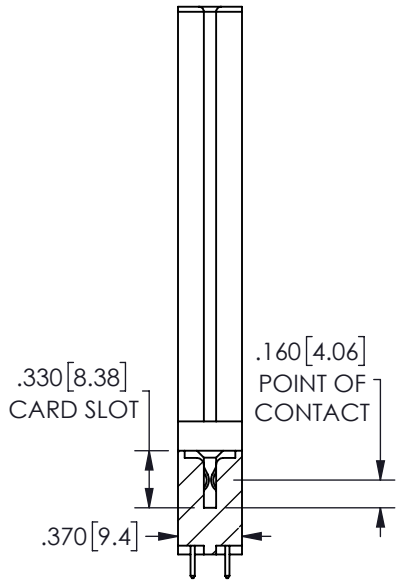

SECTION A-A

**Contact Dimensions:**  
521-P.C. Tail .025 Sq.(0.64 Sq.) - Tail LG=.150(3.81)  
.100 (2.54) Contact Spacing x .200 (5.08) Row Spacing

<b>345/395 SERIES CARD EDGE CONNECTOR</b> PART NUMBER: 345-028-521-878		ACAD REFERENCE NO.	345-ENG-MASTER
		DRAWN: R.STA.MONICA	DATE: MAY.16/2017
CHECKED:		DATE:	
SCALE:	NTS	SHEET	1 OF 2
DRAWING NUMBER		ISSUE	
345-ENG-MASTER		1	

**EDAC** INC  
TORONTO, ONTARIO  
CANADA  
YOUR CONNECTION TO QUALITY & SERVICE

THESE DRAWINGS AND SPECIFICATIONS ARE THE PROPERTY OF EDAC INC. AND SHALL NOT BE REPRODUCED, OR COPIED OR USED AS THE BASIS FOR THE MANUFACTURE OR SALE OF APPARATUS WITHOUT WRITTEN PERMISSION.

**Contact Description:**  
**559-90 Degree Bend (Code 541 Contacts)**

THIS IS A C.A.D. GENERATED DRAWING  
 DO NOT MAKE MANUAL REVISIONS TO MASTER.



ISSUE NUMBER	
ORIGINAL	①



**Contact Code 555**



**Contact Code 556**

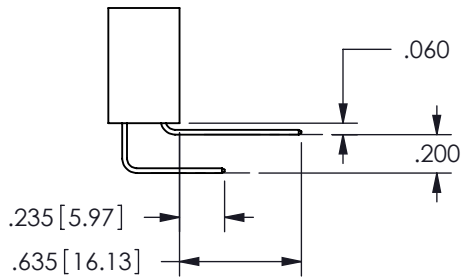

**Contact Code 558**

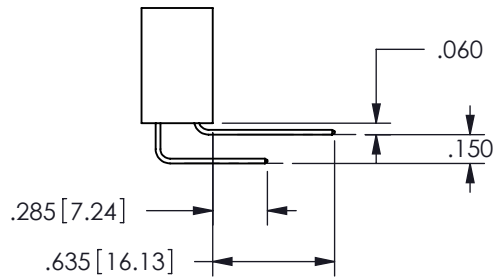

**Contact Code 559**



**Contact Code 560**

- INSULATOR MATERIAL: THERMOPLASTIC POLYESTER, UL 94V-0
- DAP MATERIAL AVAILABLE UPON REQUEST
- CONTACT MATERIAL: COPPER ALLOY
- CONTACT PLATING: GOLD ON THE MATING AREA, TIN PLATING ON THE CONTACT TAILS, NICKEL UNDERPLATE

**345/395 SERIES CARD EDGE CONNECTOR  
 CONTACT CODE 555,556,558,559,560 DIMENSIONS**



**EDAC INC**  
 TORONTO, ONTARIO  
 CANADA

YOUR CONNECTION TO QUALITY & SERVICE

THESE DRAWINGS AND SPECIFICATIONS  
 ARE THE PROPERTY OF EDAC INC. AND  
 SHALL NOT BE REPRODUCED, OR COPIED  
 OR USED AS THE BASIS FOR THE  
 MANUFACTURE OR SALE OF APPARATUS  
 WITHOUT WRITTEN PERMISSION.

ACAD REFERENCE NO.	345-ENG-MASTER
DRAWN: R.STA.MONICA	DATE: MAY.16/2017
CHECKED:	DATE:
SCALE: 1:1	SHEET 2 OF 2
DRAWING NUMBER 345-ENG-MASTER	ISSUE 1