

## 1S8W\_2RP Series

1W - Dual/Single Output - Wide Input - Isolated & Regulated  
DC-DC Converter



## DC-DC Converter

1 Watt

- ⊕ Wide 2:1 Input Voltage Range
- ⊕ High Efficiency up to 81%
- ⊕ 1W Single and Dual outputs
- ⊕ I/O Isolation 2KVDC, 4KVDC and 5,2KVDC
- ⊕ Operating Temperature Range: -40°C to +100°C
- ⊕ Continuous Short Circuit Protection (SCP)
- ⊕ Remote ON/OFF Control

The 1S8W\_S & 1S8W\_D series are specially designed for applications where a wide range input voltage power supplies are isolated from the input power supply in a distributed power supply system on a circuit board.

These products apply to:

- 1) Where the voltage of the input power supply is wide range (voltage range ≤ 2:1)
- 2) Where isolation is necessary between input and output (isolation voltage ≤ 2000VDC/4000VDC/5200VDC)
- 3) Where the regulation of the output voltage and the output ripple noise are demanded



Common specifications	
Input filter:	Capacitor
Short circuit protection:	Continuous
Temperature rise at full load:	15°C TYP
Cooling:	Free air convection
Operation temperature range:	-40°C ~ +100°C
Operating case temperature:	110°C MAX
Storage temperature range:	-55°C ~ +125°C
Storage humidity range:	< 95%
Lead temperature range:	300°C MAX, 1.5mm from case for 10 sec
No-load power consumption:	50mW TYP / 150mW MAX
Temperature coefficient:	-40°C to +85°C ambient 0.015 %/°C TYP
Operating Frequency:	150kHz MIN (optional typ. 200kHz)
Case material:	Non-conductive black plastic [UL94-V0]
Potting material:	Epoxy [UL94-V0]
MTBF (MIL-HDBK 217F):	+25°C: 3650x10 <sup>3</sup> hours +85°C: 647x10 <sup>3</sup> hours
Weight:	4.7g

Output specifications						
Item	Test condition	Min	Typ	Max	Units	
Output voltage accuracy	Nominal Vin and full load		±2		%	
Line regulation	Vin=min to max, full load		±0.5		%	
Load regulation	20% to 100% full load		±0.5		%	
Output Ripple & Noise	20MHz Bandwidth			60	mVp-p	
Remote Power OFF (leave open if not used) (15 VDC max.)	Device ON				open or <0.8 VDC	
	Device OFF Device OFF (Stand by input current)				CTRL>1.5VDC 0.5mA max.	

### Example:

**1S8W\_0505S2RP**  
**1=1Watt; S8= SIP8; W=wide input (2:1); 4,5 - 9Vin; 5Vout;**  
**S= Single Output; 2= 2000VDC; R= Regulated Output**  
**P= Short Circuit Protection**

### Note:

1. All specifications measured at Ta=25°C, humidity<75%, nominal input voltage and rated output load unless otherwise specified.
2. In this datasheet, all the test methods of indications are based on corporate standards.

Isolation specifications					
Item	Test condition	Min	Typ	Max	Units
Isolation voltage	Tested for 1 minute and 0,5mA max.	2000 4000 5200			VDC
Isolation resistance	500VDC, input to output	15			GΩ
Isolation capacitance	100KHz		30		pF

## 1S8W\_2RP Series

1W - Dual/Single Output - Wide Input - Isolated & Regulated DC-DC Converter

Part Number	Input Voltage [V]	Output Voltage [VDC]	Output Current [mA, max]	Efficiency [%, typ]	Max. Capacitive Load [ $\mu$ F]
1S8W_xx03SXR	4.5-9, 9-18, 18-36, 36-75	3.3	200	77-78	470
1S8W_xx05SXR	4.5-9, 9-18, 18-36, 36-75	5	200	78-80	470
1S8W_xx09SXR	4.5-9, 9-18, 18-36, 36-75	9	111	78-80	330
1S8W_xx12SXR	4.5-9, 9-18, 18-36, 36-75	12	83	78-81	220
1S8W_xx15SXR	4.5-9, 9-18, 18-36, 36-75	15	66	78-81	220
1S8W_xx03DXR	4.5-9, 9-18, 18-36, 36-75	$\pm$ 3.3	$\pm$ 100	76-78	$\pm$ 220
1S8W_xx05DXR	4.5-9, 9-18, 18-36, 36-75	$\pm$ 5	$\pm$ 100	78-80	$\pm$ 220
1S8W_xx09DXR	4.5-9, 9-18, 18-36, 36-75	$\pm$ 9	$\pm$ 55	78-80	$\pm$ 150
1S8W_xx12DXR	4.5-9, 9-18, 18-36, 36-75	$\pm$ 12	$\pm$ 42	78-81	$\pm$ 100
1S8W_xx15DXR	4.5-9, 9-18, 18-36, 36-75	$\pm$ 15	$\pm$ 33	78-81	$\pm$ 100

- X=2=2KVDC; X=4=4KVDC; X=5,2=5,2KVDC
- xx=Input Voltage (possible for other input and output voltage combinations on request)  
 Vin=4.5-9V, xx=05  
 Vin=9-18V, xx=12  
 Vin=18-36V, xx=24  
 Vin=36-75V, xx=48

## Functional block diagram

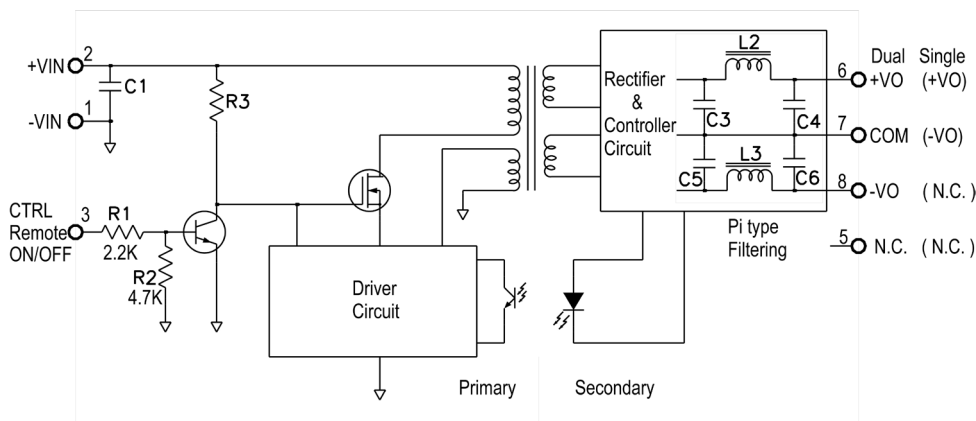

Input voltage	C1 values
4.5-18V	10 $\mu$ F/25V
18-36V	4.7 $\mu$ F/50V
36-75V	1 $\mu$ F/100V

## Mechanical dimensions and footprint

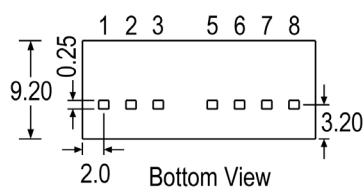
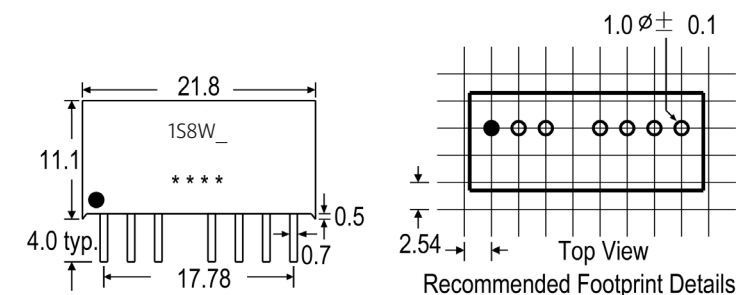

### Pin Connections

Pin#	Single	Dual
1	-Vin	-Vin
2	+Vin	+Vin
3	CTRL	CTRL
5	NC	NC
6	+Vout	+Vout
7	-Vout	COM
8	NC	-Vout

NC=No Connection

CTRL=Remote ON/OFF Control

## 1S8W\_2RP Series

1W - Dual/Single Output - Wide Input - Isolated & Regulated DC-DC Converter

### Typical characteristics

Derating graph (Natural convection)

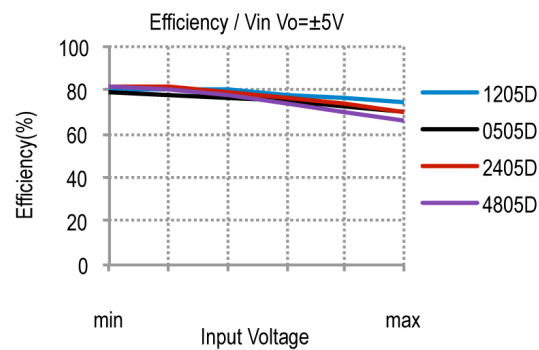
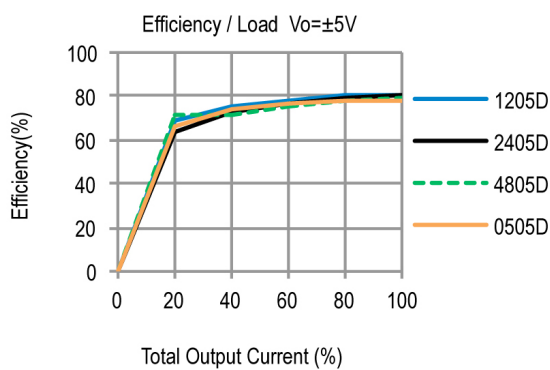
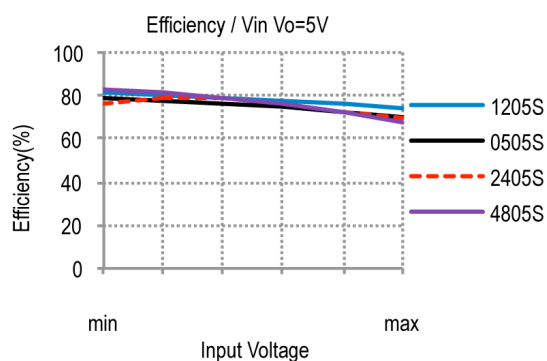
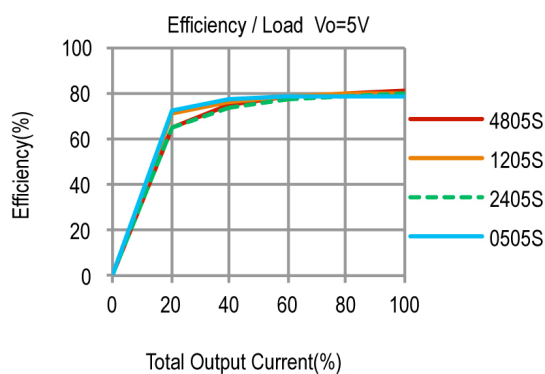
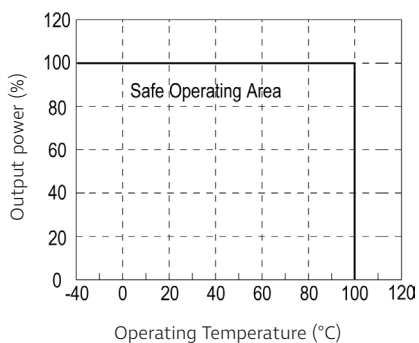

### Tube outline

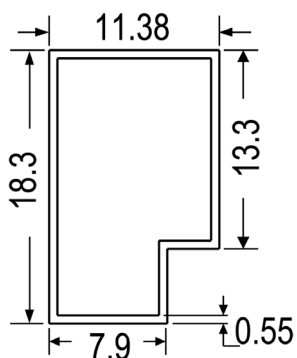

**Note:**  
Unit: mm[inch]  
General tolerances: ±0.50mm

L=520mm  
Tube quantity: 23pcs