

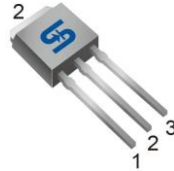

ITO-220



TO-251 (IPAK)



Pin Definition:

1. Gate
2. Drain
3. Source

Key Parameter Performance

Parameter	Value	Unit
V_{DS}	600	V
$R_{DS(on)}$ (max)	0.9	Ω
Q_g	9.7	nC

TO-252 (DPAK)



Features

- Super-Junction technology
- High performance due to small figure-of-merit
- High ruggedness performance
- High commutation performance

Application

- Power Supply.
- Lighting

Ordering Information

Part No.	Package	Packing
TSM60N900CI C0G	ITO-220	50pcs / Tube
TSM60N900CH C5G	TO-251	75pcs / Tube
TSM60N900CP ROG	TO-252	2.5kpcs / 13" Reel

Note: "G" denotes for Halogen- and Antimony-free as those which contain <900ppm bromine, <900ppm chlorine (<1500ppm total Br + Cl) and <1000ppm antimony compounds

Block Diagram

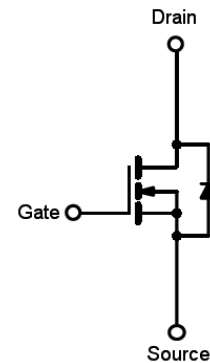

N-Channel MOSFET

Absolute Maximum Ratings ($T_C = 25^\circ\text{C}$ unless otherwise noted)

Parameter	Symbol	Limit		Unit
		ITO-220	IPAK/DPAK	
Drain-Source Voltage	V_{DS}	600		V
Gate-Source Voltage	V_{GS}	±30		V
Continuous Drain Current ^(Note 1)	I_D	$T_C = 25^\circ\text{C}$		A
Pulsed Drain Current ^(Note 2)				
Total Power Dissipation @ $T_C = 25^\circ\text{C}$	P_{DTOT}	20	50	W
Single Pulsed Avalanche Energy ^(Note 3)	E_{AS}	81		mJ
Single Pulsed Avalanche Current ^(Note 3)	I_{AS}	1.8		A
Operating Junction and Storage Temperature Range	T_J, T_{STG}	- 55 to +150		°C



Thermal Performance

Parameter	Symbol	Limit		Unit
		ITO-220	IPAK/DPAK	
Junction to Case Thermal Resistance	$R_{\theta JC}$	6.25	2.5	°C/W
Junction to Ambient Thermal Resistance	$R_{\theta JA}$	62		°C/W

Electrical Specifications ($T_C = 25^\circ\text{C}$ unless otherwise noted)

Parameter	Conditions	Symbol	Min	Typ	Max	Unit
Static (Note 4)						
Drain-Source Breakdown Voltage	$V_{GS} = 0V, I_D = 250\mu A$	BV_{DSS}	600	--	--	V
Gate Threshold Voltage	$V_{DS} = V_{GS}, I_D = 250\mu A$	$V_{GS(TH)}$	2	3	4	V
Gate Body Leakage	$V_{GS} = \pm 30V, V_{DS} = 0V$	I_{GSS}	--	--	± 100	nA
Zero Gate Voltage Drain Current	$V_{DS} = 600V, V_{GS} = 0V$	I_{DSS}	--	--	1	μA
Drain-Source On-State Resistance	$V_{GS} = 10V, I_D = 2.3A$	$R_{DS(ON)}$	--	0.72	0.9	Ω
Dynamic (Note 5)						
Total Gate Charge	$V_{DS} = 380V, I_D = 2.3A,$ $V_{GS} = 10V$	Q_g	--	9.7	--	nC
Gate-Source Charge		Q_{gs}	--	2.3	--	
Gate-Drain Charge		Q_{gd}	--	3.6	--	
Input Capacitance	$V_{DS} = 100V, V_{GS} = 0V,$ $f = 1.0MHz$	C_{iss}	--	480	--	pF
Output Capacitance		C_{oss}	--	36	--	
Gate Resistance	$f = 1MHz, \text{open drain}$	R_g	--	3.4	--	Ω
Switching (Note 6)						
Turn-On Delay Time	$V_{DD} = 380V,$ $R_{GEN} = 4.7\Omega,$ $I_D = 2.3A, V_{GS} = 10V,$	$t_{d(on)}$	--	12	--	ns
Turn-On Rise Time		t_r	--	16	--	
Turn-Off Delay Time		$t_{d(off)}$	--	22	--	
Turn-Off Fall Time		t_f	--	12	--	
Source-Drain Diode (Note 4)						
Forward On Voltage	$I_S = 4.5A, V_{GS} = 0V$	V_{SD}	--	--	1.4	V
Reverse Recovery Time	$V_R = 200V, I_S = 2.3A$ $dI_F/dt = 100A/\mu s$	t_{rr}	--	179	--	ns
Reverse Recovery Charge		Q_{rr}	--	1.2	--	μC

Notes:

1. Current limited by package
2. Pulse width limited by the maximum junction temperature
3. $L = 50mH, I_{AS} = 1.8A, V_{DD} = 50V, R_G = 25\Omega, \text{Starting } T_J = 25^\circ\text{C}$
4. Pulse test: $PW \leq 300\mu s, \text{duty cycle} \leq 2\%$
5. For DESIGN AID ONLY, not subject to production testing.
6. Switching time is essentially independent of operating temperature.

Electrical Characteristics Curves

Output Characteristics

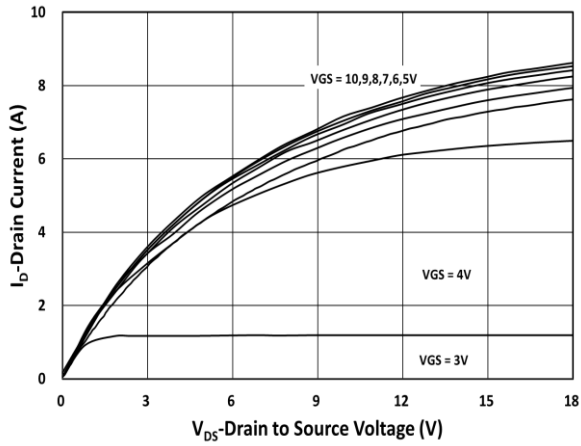

Transfer Characteristics

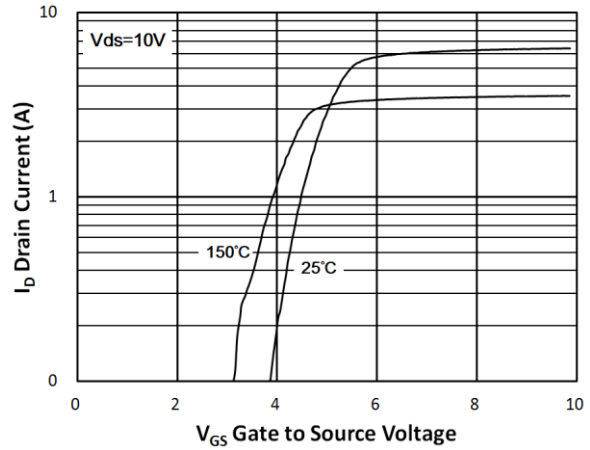

On-Resistance vs. Drain Current

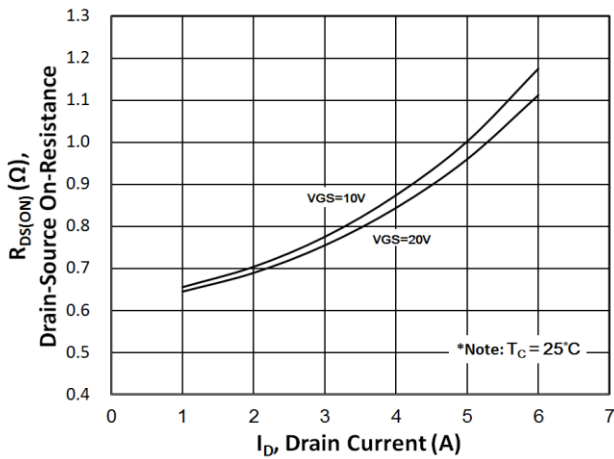

Gate Charge vs. Gate-Source Voltage

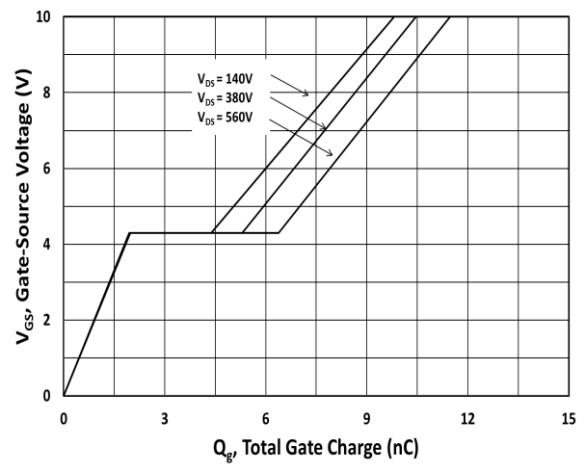

On-Resistance vs. Junction Temperature

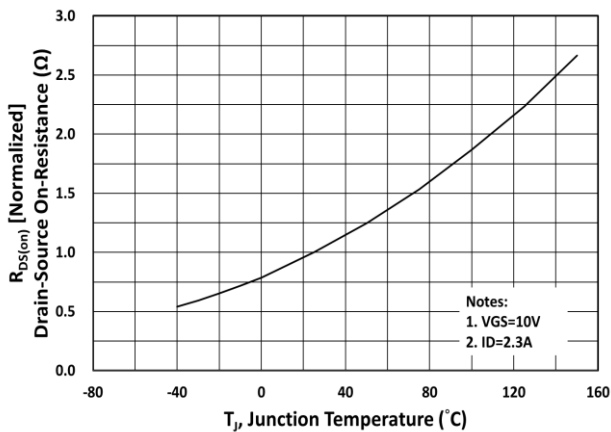

Source-Drain Diode Forward Voltage vs. Current

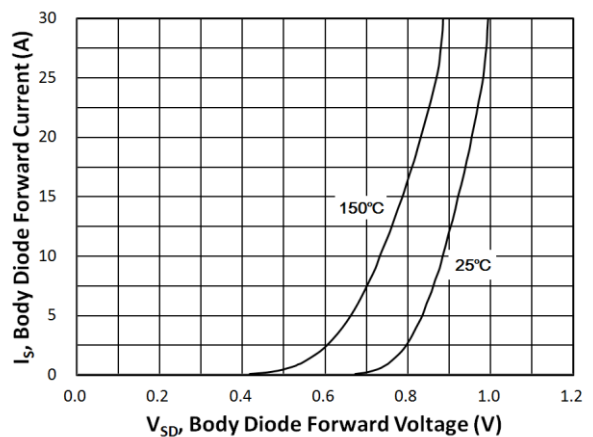

Electrical Characteristics Curves

Capacitance vs. Drain-Source Voltage

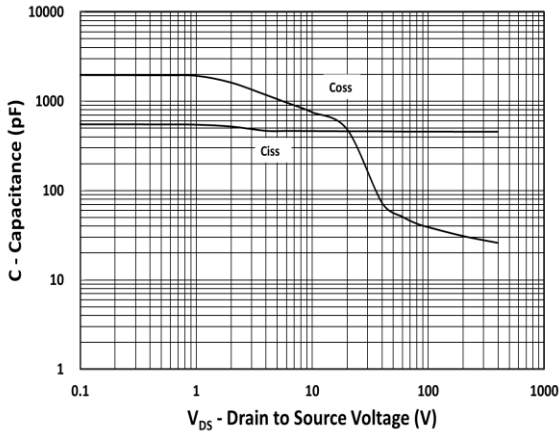

BV_{DSS} vs. Junction Temperature

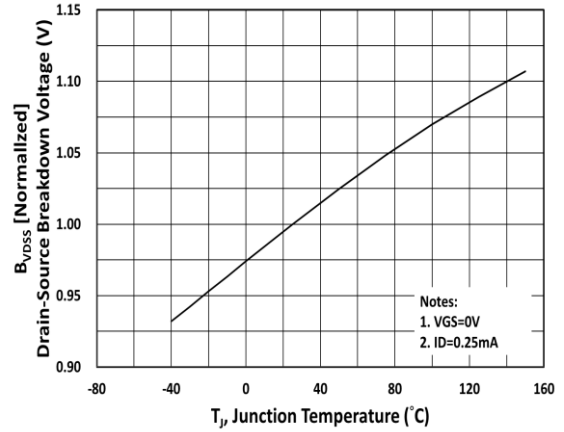

Maximum Safe Operating Area (DPAK/IPAK)

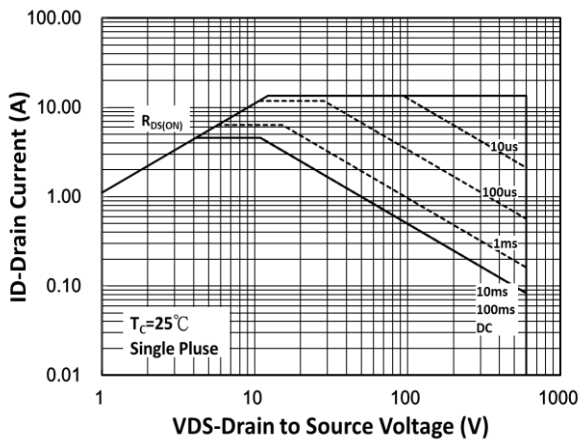

Maximum Safe Operating Area (ITO-220)

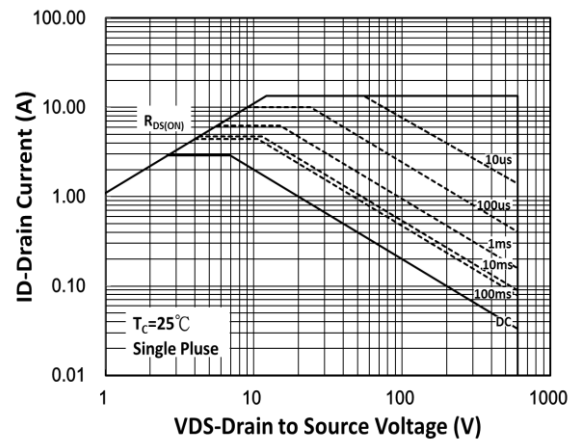



Electrical Characteristics Curves

Normalized Thermal Transient Impedance, Junction-to-Case (DPAK/IPAK)

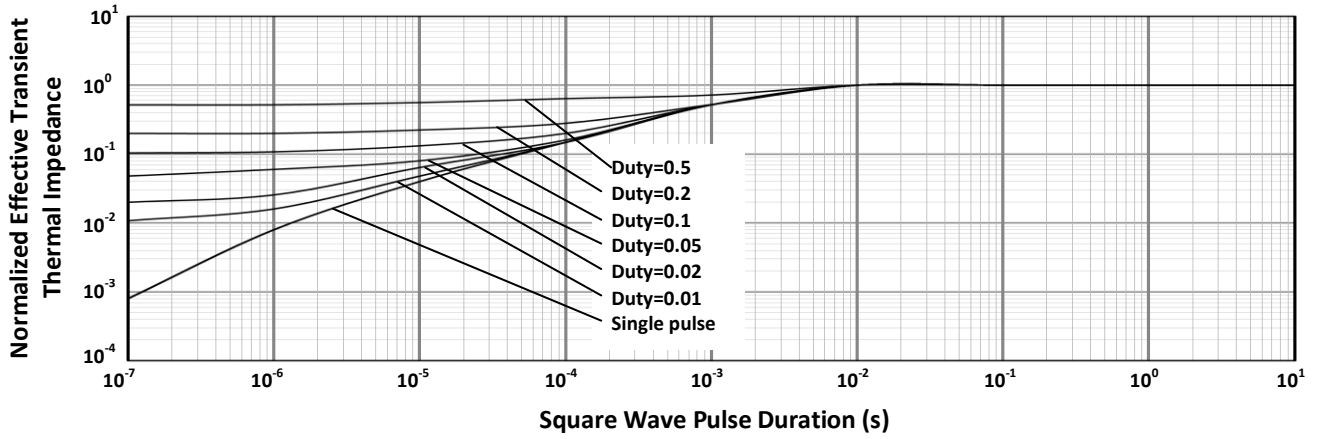

Normalized Thermal Transient Impedance, Junction-to-Case (ITO-220)

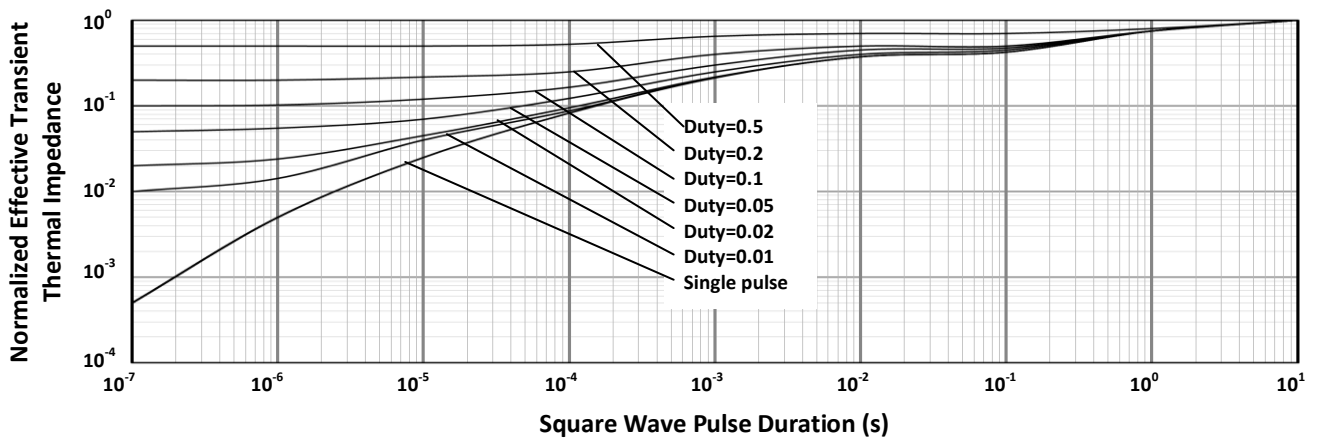



ITO-220 Mechanical Drawing

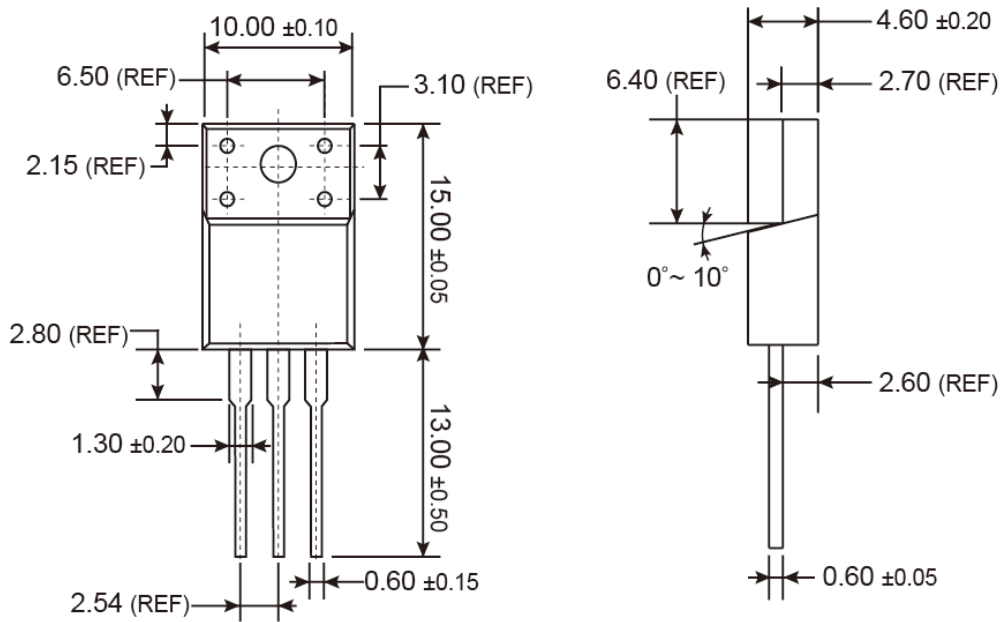

Unit: Millimeters

Marking Diagram

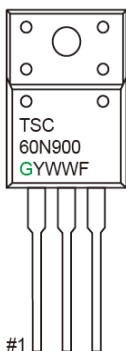

- G** = Halogen Free
- Y** = Year Code
- WW** = Week Code (01~52)
- F** = Factory Code



TO-251 (IPAK) Mechanical Drawing

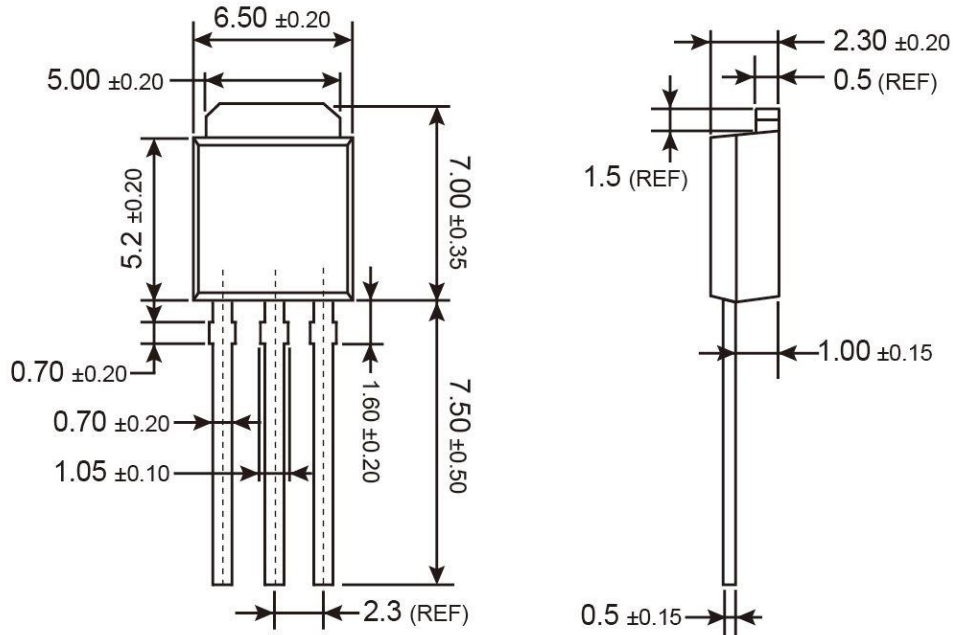

Unit: Millimeters

Marking Diagram

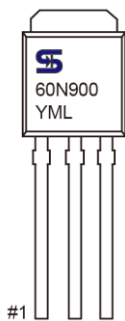

- Y** = Year Code
- M** = Month Code for Halogen Free Product
(O=Jan, P=Feb, Q=Mar, R=Apl, S=May, T=Jun, U=Jul, V=Aug, W=Sep, X=Oct, Y=Nov, Z=Dec)
- L** = Lot Code



TO-252 (DPAK) Mechanical Drawing

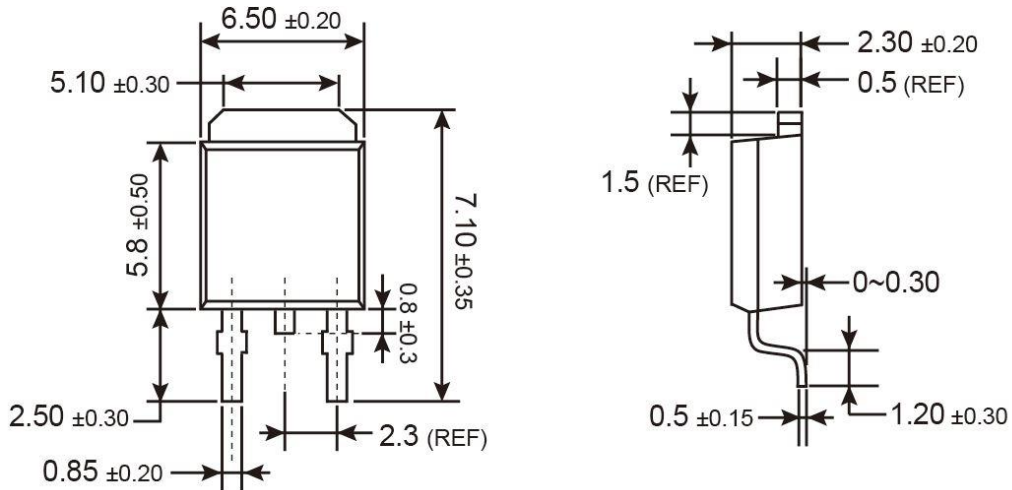

Unit: Millimeters

Marking Diagram

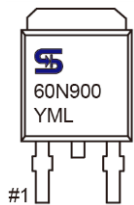

- Y** = Year Code
- M** = Month Code for Halogen Free Product
(O=Jan, P=Feb, Q=Mar, R=Apl, S=May, T=Jun, U=Jul, V=Aug, W=Sep, X=Oct, Y=Nov, Z=Dec)
- L** = Lot Code

Notice

Specifications of the products displayed herein are subject to change without notice. TSC or anyone on its behalf, assumes no responsibility or liability for any errors or inaccuracies.

Information contained herein is intended to provide a product description only. No license, express or implied, to any intellectual property rights is granted by this document. Except as provided in TSC's terms and conditions of sale for such products, TSC assumes no liability whatsoever, and disclaims any express or implied warranty, relating to sale and/or use of TSC products including liability or warranties relating to fitness for a particular purpose, merchantability, or infringement of any patent, copyright, or other intellectual property right.

The products shown herein are not designed for use in medical, life-saving, or life-sustaining applications. Customers using or selling these products for use in such applications do so at their own risk and agree to fully indemnify TSC for any damages resulting from such improper use or sale.