

42 V Input Window Voltage Detector for Automotive Applications

No. EC-405-221007

OVERVIEW

The R3152N is a window voltage detector suited for achieving the functional safety. This device monitors over- and under- voltage of the output voltage from the power supply IC for a microprocessor and a sensor, and can prevent malfunction of system caused by abnormal voltage.

KEY BENEFITS

- A stable voltage with supplying the battery voltage can provide the power supply and the voltage supervising separately.
- High-accuracy detection enables with Overvoltage/Undervoltage Detection Accuracy of -1.25% to 0.75% and Hysteresis of 1.5%.
- Small package of SOT-23-6 is adopted, and a safe and secure pin assignment with considering a short among adjacent pins.

KEY SPECIFICATIONS

- Operating Voltage Range (Max. Rating): 3.0 V to 42.0 V (50.0 V)
- Operating Temperature Range: -40°C to 125°C
- Supply Current: Typ. 1.5 μ A
- Overvoltage Detection: 1.1 V to 5.9 V (0.01 V step)
- Undervoltage Detection: 1.0 V to 4.8 V (0.01 V step)
- Detection Release Hysteresis: A, Typ. 1.0% with hysteresis
B, No hysteresis
- Detection Voltage Accuracy:
 $\pm 0.5\%$ ($T_a = 25^\circ\text{C}$)
 -1.25% to 0.75% (-40°C to 125°C)
- Release Delay Time: Typ. 4 ms ($C_D = 0.01 \mu\text{F}$)
- Output Type: Nch. Open Drain

SELECTION GUIDE

Product Name	Package	Quantity per Reel
R3152Nxxx\$-TR-#E	SOT-23-6	3,000 pcs

xxx: The combination of an overvoltage detection setting voltage (V_{OVSET}) and an undervoltage detection setting voltage (V_{UVSET})
Refer to *Product-specific Electrical Characteristics* for more details.

\$: Hysteresis

\$	Hysteresis
A	Yes
B	No

#: Quality Class

Refer to *SELECTION GUIDE* for details.

TYPICAL APPLICATIONS

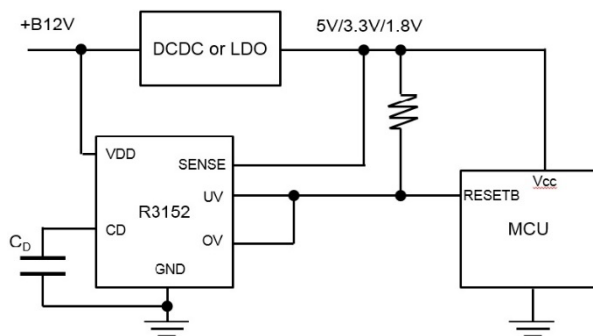

C_D : a capacitor set according to the release delay times

PACKAGE

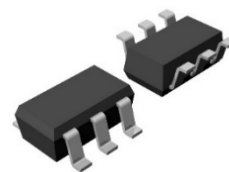

SOT-23-6
2.9 x 2.8 x 1.1 (mm)

APPLICATIONS

- Power Supply Voltage Monitoring for ASIL-B/C/D Systems Including ECU and ADAS
- Power Supply Voltage Monitoring for Control Units Including EV Inverters and Charge Controllers

SELECTION GUIDE

The overvoltage detection setting voltage (V_{OVSET}) and the undervoltage detection setting voltage (V_{UVSET}) are user-selectable options.

Selection Guide

Product Name	Package	Quantity per Reel	Pb Free	Halogen Free
R3152Nxxx\$-TR-#E	SOT-23-6	3,000 pcs	Yes	Yes

xxx: The combination of an overvoltage detection setting voltage (V_{OVSET}) and an undervoltage detection setting voltage (V_{UVSET}).

Refer to *Product-specific Electrical Characteristics* for more details.

\$: Hysteresis

\$	Hysteresis
A	Yes
B	No

#: Quality Class

#	Operating Temp. Range	Test Temp.
A	-40°C to 125°C	25°C, High
K	-40°C to 125°C	Low, 25°C, High

BLOCK DIAGRAM

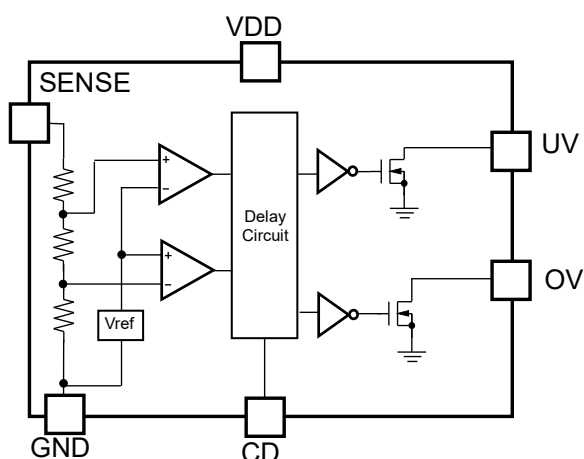

R3152N Block Diagram

PIN DESCRIPTIONS

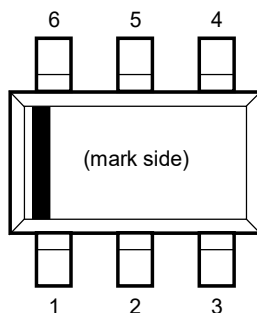

SOT-23-6 Pin Configuration

Pin Description

Pin No.	Symbol	Description
1	VDD	Supply Voltage Pin
2	CD	VD Release Delay Time Set Pin (for connecting with external capacitor for delay)
3	UV	Undervoltage Detection Output Pin ("Low" at detection)
4	OV	Overvoltage Detection Output Pin ("Low" at detection)
5	GND	GND Pin
6	SENSE	SENSE Pin

Internal Equivalent Circuit for Each Pin

UV Pin

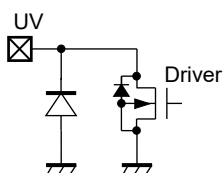

OV Pin

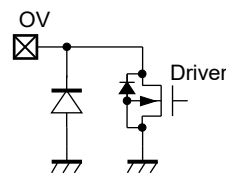

CD Pin

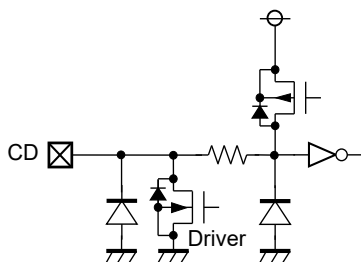

SENSE Pin

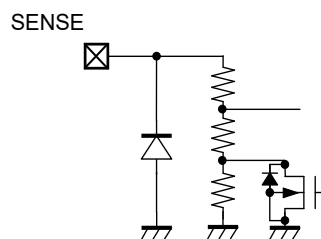

ABSOLUTE MAXIMUM RATINGS

Absolute Maximum Ratings

Symbol	Parameter	Rating	Unit
V_{DD}	Supply Voltage	-0.3 to 50.0	V
	Peak Voltage ⁽¹⁾	60	V
V_{CD}	CD Pin Output Voltage	-0.3 to 50.0	V
V_{UVOUT}	UV Pin Output Voltage	-0.3 to 7.0	V
V_{OVOUT}	OV Pin Output Voltage	-0.3 to 7.0	V
V_{SENSE}	SENSE Pin Input Voltage	-0.3 to 7.0	V
I_{UVOUT}	UV Pin Output Current	30	mA
I_{OVOUT}	OV Pin Output Current	30	mA
P_D	Power Dissipation ⁽²⁾ (JEDEC STD.51-7)	830	mW
T_j	Junction Temperature Range	-40 to 150	°C
T_{stg}	Storage Temperature Range	-55 to 150	°C

ABSOLUTE MAXIMUM RATINGS

Electronic and mechanical stress momentarily exceeded absolute maximum ratings may cause permanent damage and may degrade the life time and safety for both device and system using the device in the field. The functional operation at or over these absolute maximum ratings are not assured.

RECOMMENDED OPERATING CONDITIONS

Recommend Operating Conditions

Symbol	Parameter	Rating	Unit
V_{DD}	Operating Voltage	3.0 to 42	V
V_{SENSE}	SENSE Pin Input Voltage	0 to 6.0	V
T_a	Operating Temperature Range	-40 to 125	°C

RECOMMENDED OPERATING CONDITIONS

All of electronic equipment should be designed that the mounted semiconductor devices operate within the recommended operating conditions. The semiconductor devices cannot operate normally over the recommended operating conditions, even if they are used over such ratings by momentary electronic noise or surge. And the semiconductor devices may receive serious damage when they continue to operate over the recommended operating conditions.

⁽¹⁾ Duration Time: 200 ms

⁽²⁾ Refer to *POWER DISSIPATION* for detailed information.

ELECTRICAL CHARACTERISTICS

$V_{DD} = 14\text{ V}$, $C_D = 0.01\ \mu\text{F}$, pulled-up to 5 V with 100 k Ω , unless otherwise specified.

The specifications surrounded by are guaranteed by design engineering at $-40^\circ\text{C} \leq T_a \leq 125^\circ\text{C}$.

R3152N (-AE) Electrical Characteristics

($T_a = 25^\circ\text{C}$)

Symbol	Parameter	Test Conditions/Comments	Min.	Typ.	Max.	Unit
V_{OVDET}	Overvoltage (OV) Detector Threshold	$T_a = 25^\circ\text{C}$	x0.995		x1.005	V
		$-40^\circ\text{C} \leq T_a \leq 125^\circ\text{C}$	x0.9875		x1.0075	V
V_{UVDET}	Undervoltage (UV) Detector Threshold	$T_a = 25^\circ\text{C}$	x0.995		x1.005	V
		$-40^\circ\text{C} \leq T_a \leq 125^\circ\text{C}$	x0.9875		x1.0075	V
V_{OVHYS}	Overvoltage (OV) Threshold Hysteresis	With Hysteresis	$\frac{V_{OVDET}}{\times 0.005}$	$V_{OVDET} \times 0.01$	$\frac{V_{OVDET}}{\times 0.015}$	V
		No Hysteresis	0		10	mV
V_{UVHYS}	Undervoltage (UV) Threshold Hysteresis	With Hysteresis	$\frac{V_{UVDET}}{\times 0.005}$	$V_{UVDET} \times 0.01$	$\frac{V_{UVDET}}{\times 0.015}$	V
		No Hysteresis	0		10	mV
I_{SS}	Consumption Current	$V_{UVDET} < \text{SENSE} < V_{OVDET}$		1.5	3.2	μA
R_{SENSE}	SENSE Pin Resistance	$V_{UVDET} \geq 1.6\text{V}$, $V_{OVDET} \geq 1.84\text{V}$	7	14	28	$\text{M}\Omega$
		$V_{UVDET} < 1.6\text{V}$, $V_{OVDET} < 1.84\text{V}$	3	6	12	
V_{UVLO}	UVLO Detector Threshold			1.8	2.8	V
$V_{UVLOHYS}$	UVLO Threshold Hysteresis			0.1	0.2	V
V_{OVOUT}	Overvoltage (OV) pulled-up output voltage				6.0	V
V_{UVOUT}	Undervoltage (UV) pulled-up output voltage				6.0	V
V_{DDLOV}	Overvoltage (OV) Low-operating Voltage ⁽¹⁾				1.7	V
V_{DDLUV}	Undervoltage (UV) Low-operating Voltage ⁽¹⁾				1.7	V
I_{OUT}	OV Pin Nch. Driver Output Current	$V_{DD} = 3.0$, $V_{DS} = 0.1\text{ V}$	0.8	1.8		mA
	UV Pin Nch. Driver Output Current	$V_{DD} = 3.0$, $V_{DS} = 0.1\text{ V}$	0.8	1.8		mA
I_{LEAK}	OV Pin Nch.Driver Leak Current	$V_{OVOUT} = 5.5\text{ V}$			0.3	μA
	UV Pin Nch Driver Leak Current	$V_{UVOUT} = 5.5\text{ V}$			0.3	μA
t_{DELAY}	Release Delay Time		2.5	4	8	ms

All test items listed under Electrical Characteristics are done under the pulse load condition ($T_j \approx T_a = 25^\circ\text{C}$).

⁽¹⁾ Minimum value of power supply voltage when an output voltage will become less than 0.1V at detection.
(Pulled-up resistance: 100 k Ω , Pulled-up voltage: 5 V)

$V_{DD} = 14\text{ V}$, $C_D = 0.01\text{ }\mu\text{F}$, pulled-up to 5 V with 100 k Ω , unless otherwise specified.

R3152N (-KE) Electrical Characteristics

(-40°C ≤ Ta ≤ 125°C)

Symbol	Parameter	Test Conditions/Comments	Min.	Typ.	Max.	Unit
V _{OVDET}	Overvoltage (OV) Detector Threshold	Ta = 25°C	x0.995		x1.005	V
		-40°C ≤ Ta ≤ 125°C	x0.9875		x1.0075	V
V _{UVDET}	Undervoltage (UV) Detector Threshold	Ta = 25°C	x0.995		x1.005	V
		-40°C ≤ Ta ≤ 125°C	x0.9875		x1.0075	V
V _{OVHYS}	Overvoltage (OV) Threshold Hysteresis	With Hysteresis	V _{OVDET} ×0.005	V _{OVDET} ×0.01	V _{OVDET} ×0.015	V
		No Hysteresis	0		10	mV
V _{UVHYS}	Undervoltage (UV) Threshold Hysteresis	With Hysteresis	V _{UVDET} ×0.005	V _{UVDET} ×0.01	V _{UVDET} ×0.015	V
		No Hysteresis	0		10	mV
I _{SS}	Consumption Current	V _{UVDET} < SENSE < V _{OVDET}		1.5	3.2	μA
R _{SENSE}	SENSE Pin Resistance	V _{UVDET} ≥ 1.6V, V _{OVDET} ≥ 1.84V	7	14	28	MΩ
		V _{UVDET} < 1.6V, V _{OVDET} < 1.84V	3	6	12	
V _{UVLO}	UVLO Detector Threshold			1.8	2.8	V
V _{UVLOHYS}	UVLO Threshold Hysteresis			0.1	0.2	V
V _{OVOUT}	Overvoltage (OV) pulled-up output voltage				6.0	V
V _{UVOUT}	Undervoltage (UV) pulled-up output voltage				6.0	V
V _{DDLOV}	Overvoltage (OV) Low-operating Voltage ⁽¹⁾				1.7	V
V _{DDLUV}	Undervoltage (UV) Low-operating Voltage ⁽¹⁾				1.7	V
I _{OUT}	OV Pin Nch. Driver Output Current	V _{DD} = 3.0, V _{DS} = 0.1 V	0.8	1.8		mA
	UV Pin Nch. Driver Output Current	V _{DD} = 3.0, V _{DS} = 0.1 V	0.8	1.8		mA
I _{LEAK}	OV Pin Nch. Driver Leak Current	V _{OVOUT} = 5.5 V			0.3	μA
	UV Pin Nch Driver Leak Current	V _{UVOUT} = 5.5 V			0.3	μA
t _{DELAY}	Release Delay Time		2.5	4	8	ms

All test items listed under Electrical Characteristics are done under the pulse load condition (T_j ≈ Ta = 25°C).

⁽¹⁾ Minimum value of power supply voltage when an output voltage will become less than 0.1V at detection.
(Pulled-up resistance: 100 k Ω , Pulled-up voltage: 5 V)

$V_{DD} = 14\text{ V}$, $C_D = 0.01\ \mu\text{F}$, pulled-up to 5 V with 100 k Ω , unless otherwise specified.

The specifications surrounded by are guaranteed by design engineering at $-40^\circ\text{C} \leq T_a \leq 125^\circ\text{C}$.

R3152N (-AE) Product-specific Electrical Characteristics

(Ta = 25°C)

Product Name	V_{OVDET} (V)			V_{UVDET} (V)			V_{OVHYS} (V)			V_{UVHYS} (V)		
	Min.	Typ.	Max.	Min.	Typ.	Max.	Min.	Typ.	Max.	Min.	Typ.	Max.
R3152N001A	5.27350	5.30	5.32650	4.67650	4.70	4.72350	0.02650	0.05300	0.07950	0.02350	0.04700	0.07050
R3152N002A	3.52230	3.54	3.55770	3.03475	3.05	3.06525	0.01770	0.03540	0.05310	0.01525	0.03050	0.04575
R3152N003B	3.55215	3.57	3.58785	2.48750	2.50	2.51250	0	-	0.01000	0	-	0.01000
R3152N004A	1.86065	1.87	1.87935	1.73130	1.74	1.74870	0.00935	0.01870	0.02805	0.00870	0.01740	0.02610
R3152N005A	3.41285	3.43	3.44715	3.17405	3.19	3.20595	0.01715	0.03430	0.05145	0.01595	0.03190	0.04785
R3152N013A	1.32335	1.33	1.33665	1.16415	1.17	1.17585	0.00665	0.01330	0.01995	0.00585	0.01170	0.01755
R3152N014A	1.16415	1.17	1.17585	1.06963	1.075	1.08037	0.00585	0.01170	0.01755	0.00538	0.01075	0.01613
R3152N015A	1.28355	1.29	1.29645	1.15420	1.16	1.16580	0.00645	0.01290	0.01935	0.00580	0.01160	0.01740
R3152N017A	3.55215	3.57	3.58785	2.72630	2.74	2.75370	0.01785	0.03570	0.05355	0.01370	0.02740	0.04110
R3152N020A	1.24375	1.25	1.25625	1.11440	1.12	1.12560	0.00625	0.01250	0.01875	0.00560	0.01120	0.01680
R3152N201B	1.23380	1.24	1.24620	1.16415	1.17	1.17585	0	-	0.01000	0	-	0.01000
R3152N101B	2.58700	2.60	2.61300	2.39795	2.41	2.42205	0	-	0.01000	0	-	0.01000
R3152N102B	3.41285	3.43	3.44715	3.16410	3.18	3.19590	0	-	0.01000	0	-	0.01000
R3152N203A	1.39300	1.40	1.40700	0.99500	1.00	1.00500	0.00700	0.01400	0.02100	0.00500	0.01000	0.01500
R3152N204A	1.62185	1.63	1.63815	1.40295	1.41	1.41705	0.00815	0.01630	0.02445	0.00705	0.01410	0.02115
R3152N103A	5.77100	5.80	5.82900	4.75610	4.78	4.80390	0.02900	0.05800	0.08700	0.02390	0.04780	0.07170
R3152N104A	3.38300	3.40	3.41700	1.59200	1.60	1.60800	0.01700	0.03400	0.05100	0.00800	0.01600	0.02400
R3152N105A	2.98500	3.00	3.01500	2.58700	2.60	2.61300	0.01500	0.03000	0.04500	0.01300	0.02600	0.03900
R3152N106A	3.51235	3.53	3.54765	2.96510	2.98	2.99490	0.01765	0.03530	0.05295	0.01490	0.02980	0.04470

$V_{DD} = 14\text{ V}$, $C_D = 0.01\ \mu\text{F}$, pulled-up to 5 V with 100 k Ω , unless otherwise specified.

The specifications surrounded by are guaranteed by design engineering at $-40^\circ\text{C} \leq T_a \leq 125^\circ\text{C}$.

R3152N (-AE) Product-specific Electrical Characteristics

($-40^\circ\text{C} \leq T_a \leq 125^\circ\text{C}$)

Product Name	V _{OVDET} (V)			V _{UVDET} (V)			V _{OVHYS} (V)			V _{UVHYS} (V)		
	Min.	Typ.	Max.	Min.	Typ.	Max.	Min.	Typ.	Max.	Min.	Typ.	Max.
R3152N001A	5.23375	5.30	5.33975	4.64125	4.70	4.73525	0.02650	0.05300	0.07950	0.02350	0.04700	0.07050
R3152N002A	3.49575	3.54	3.56655	3.01188	3.05	3.07287	0.01770	0.03540	0.05310	0.01525	0.03050	0.04575
R3152N003B	3.52538	3.57	3.59678	2.46875	2.50	2.51875	0	-	0.01000	0	-	0.01000
R3152N004A	1.84663	1.87	1.88403	1.71825	1.74	1.75305	0.00935	0.01870	0.02805	0.00870	0.01740	0.02610
R3152N005A	3.38713	3.43	3.45573	3.15013	3.19	3.21392	0.01715	0.03430	0.05145	0.01595	0.03190	0.04785
R3152N013A	1.31338	1.33	1.33997	1.15538	1.17	1.17877	0.00665	0.01330	0.01995	0.00585	0.01170	0.01755
R3152N014A	1.15537	1.17	1.17878	1.06156	1.075	1.08307	0.00585	0.01170	0.01755	0.00538	0.01075	0.01613
R3152N015A	1.27387	1.29	1.29968	1.14550	1.16	1.16870	0.00645	0.01290	0.01935	0.00580	0.01160	0.01740
R3152N017A	3.52537	3.57	3.59678	2.70575	2.74	2.76055	0.01785	0.03570	0.05355	0.01370	0.02740	0.04110
R3152N020A	1.23438	1.25	1.25937	1.10600	1.12	1.12840	0.00625	0.01250	0.01875	0.00560	0.01120	0.01680
R3152N201B	1.22450	1.24	1.24930	1.15538	1.17	1.17877	0	-	0.01000	0	-	0.01000
R3152N101B	2.56750	2.60	2.61950	2.37988	2.41	2.42807	0	-	0.01000	0	-	0.01000
R3152N102B	3.38713	3.43	3.45572	3.14025	3.18	3.20385	0	-	0.01000	0	-	0.01000
R3152N203A	1.38250	1.40	1.41050	0.98750	1.00	1.00750	0.00700	0.01400	0.02100	0.00500	0.01000	0.01500
R3152N204A	1.60963	1.63	1.64222	1.39238	1.41	1.42057	0.00815	0.01630	0.02445	0.00705	0.01410	0.02115
R3152N103A	5.72750	5.80	5.84350	4.72025	4.78	4.81585	0.02900	0.05800	0.08700	0.02390	0.04780	0.07170
R3152N104A	3.35750	3.40	3.42550	1.58000	1.60	1.61200	0.01700	0.03400	0.05100	0.00800	0.01600	0.02400
R3152N105A	2.96250	3.00	3.02250	2.56750	2.60	2.61950	0.01500	0.03000	0.04500	0.01300	0.02600	0.03900
R3152N106A	3.48588	3.53	3.55647	2.94275	2.98	3.00235	0.01765	0.03530	0.05295	0.01490	0.02980	0.04470

$V_{DD} = 14\text{ V}$, $C_D = 0.01\ \mu\text{F}$, pulled-up to 5 V with 100 k Ω , unless otherwise specified.

R3152N (-KE) Product-specific Electrical Characteristics

(Ta = 25°C)

Product Name	V_{OVDET} (V)			V_{UVDET} (V)			V_{OVHYS} (V)			V_{UVHYS} (V)		
	Min.	Typ.	Max.	Min.	Typ.	Max.	Min.	Typ.	Max.	Min.	Typ.	Max.
R3152N001A	5.27350	5.30	5.32650	4.67650	4.70	4.72350	0.02650	0.05300	0.07950	0.02350	0.04700	0.07050
R3152N002A	3.52230	3.54	3.55770	3.03475	3.05	3.06525	0.01770	0.03540	0.05310	0.01525	0.03050	0.04575
R3152N003B	3.55215	3.57	3.58785	2.48750	2.50	2.51250	0	-	0.01000	0	-	0.01000
R3152N004A	1.86065	1.87	1.87935	1.73130	1.74	1.74870	0.00935	0.01870	0.02805	0.00870	0.01740	0.02610
R3152N005A	3.41285	3.43	3.44715	3.17405	3.19	3.20595	0.01715	0.03430	0.05145	0.01595	0.03190	0.04785
R3152N013A	1.32335	1.33	1.33665	1.16415	1.17	1.17585	0.00665	0.01330	0.01995	0.00585	0.01170	0.01755
R3152N014A	1.16415	1.17	1.17585	1.06963	1.075	1.08037	0.00585	0.01170	0.01755	0.00538	0.01075	0.01613
R3152N015A	1.28355	1.29	1.29645	1.15420	1.16	1.16580	0.00645	0.01290	0.01935	0.00580	0.01160	0.01740
R3152N017A	3.55215	3.57	3.58785	2.72630	2.74	2.75370	0.01785	0.03570	0.05355	0.01370	0.02740	0.04110
R3152N020A	1.24375	1.25	1.25625	1.11440	1.12	1.12560	0.00625	0.01250	0.01875	0.00560	0.01120	0.01680
R3152N201B	1.23380	1.24	1.24620	1.16415	1.17	1.17585	0	-	0.01000	0	-	0.01000
R3152N101B	2.58700	2.60	2.61300	2.39795	2.41	2.42205	0	-	0.01000	0	-	0.01000
R3152N102B	3.41285	3.43	3.44715	3.16410	3.18	3.19590	0	-	0.01000	0	-	0.01000
R3152N203A	1.39300	1.40	1.40700	0.99500	1.00	1.00500	0.00700	0.01400	0.02100	0.00500	0.01000	0.01500
R3152N204A	1.62185	1.63	1.63815	1.40295	1.41	1.41705	0.00815	0.01630	0.02445	0.00705	0.01410	0.02115
R3152N103A	5.77100	5.80	5.82900	4.75610	4.78	4.80390	0.02900	0.05800	0.08700	0.02390	0.04780	0.07170
R3152N104A	3.38300	3.40	3.41700	1.59200	1.60	1.60800	0.01700	0.03400	0.05100	0.00800	0.01600	0.02400
R3152N105A	2.98500	3.00	3.01500	2.58700	2.60	2.61300	0.01500	0.03000	0.04500	0.01300	0.02600	0.03900
R3152N106A	3.51235	3.53	3.54765	2.96510	2.98	2.99490	0.01765	0.03530	0.05295	0.01490	0.02980	0.04470

$V_{DD} = 14\text{ V}$, $C_D = 0.01\ \mu\text{F}$, pulled-up to 5 V with 100 k Ω , unless otherwise specified.

R3152N (-KE) Product-specific Electrical Characteristics

($-40^\circ\text{C} \leq T_a \leq 125^\circ\text{C}$)

Product Name	V_{OVDET} (V)			V_{UVDET} (V)			V_{OVHYS} (V)			V_{UVHYS} (V)		
	Min.	Typ.	Max.	Min.	Typ.	Max.	Min.	Typ.	Max.	Min.	Typ.	Max.
R3152N001A	5.23375	5.30	5.33975	4.64125	4.70	4.73525	0.02650	0.05300	0.07950	0.02350	0.04700	0.07050
R3152N002A	3.49575	3.54	3.56655	3.01188	3.05	3.07287	0.01770	0.03540	0.05310	0.01525	0.03050	0.04575
R3152N003B	3.52538	3.57	3.59678	2.46875	2.50	2.51875	0	-	0.01000	0	-	0.01000
R3152N004A	1.84663	1.87	1.88403	1.71825	1.74	1.75305	0.00935	0.01870	0.02805	0.00870	0.01740	0.02610
R3152N005A	3.38713	3.43	3.45573	3.15013	3.19	3.21392	0.01715	0.03430	0.05145	0.01595	0.03190	0.04785
R3152N013A	1.31338	1.33	1.33997	1.15538	1.17	1.17877	0.00665	0.01330	0.01995	0.00585	0.01170	0.01755
R3152N014A	1.15537	1.17	1.17878	1.06156	1.075	1.08307	0.00585	0.01170	0.01755	0.00538	0.01075	0.01613
R3152N015A	1.27387	1.29	1.29968	1.14550	1.16	1.16870	0.00645	0.01290	0.01935	0.00580	0.01160	0.01740
R3152N017A	3.52537	3.57	3.59678	2.70575	2.74	2.76055	0.01785	0.03570	0.05355	0.01370	0.02740	0.04110
R3152N020A	1.23438	1.25	1.25937	1.10600	1.12	1.12840	0.00625	0.01250	0.01875	0.00560	0.01120	0.01680
R3152N201B	1.22450	1.24	1.24930	1.15538	1.17	1.17877	0	-	0.01000	0	-	0.01000
R3152N101B	2.56750	2.60	2.61950	2.37988	2.41	2.42807	0	-	0.01000	0	-	0.01000
R3152N102B	3.38713	3.43	3.45572	3.14025	3.18	3.20385	0	-	0.01000	0	-	0.01000
R3152N203A	1.38250	1.40	1.41050	0.98750	1.00	1.00750	0.00700	0.01400	0.02100	0.00500	0.01000	0.01500
R3152N204A	1.60963	1.63	1.64222	1.39238	1.41	1.42057	0.00815	0.01630	0.02445	0.00705	0.01410	0.02115
R3152N103A	5.72750	5.80	5.84350	4.72025	4.78	4.81585	0.02900	0.05800	0.08700	0.02390	0.04780	0.07170
R3152N104A	3.35750	3.40	3.42550	1.58000	1.60	1.61200	0.01700	0.03400	0.05100	0.00800	0.01600	0.02400
R3152N105A	2.96250	3.00	3.02250	2.56750	2.60	2.61950	0.01500	0.03000	0.04500	0.01300	0.02600	0.03900
R3152N106A	3.48588	3.53	3.55647	2.94275	2.98	3.00235	0.01765	0.03530	0.05295	0.01490	0.02980	0.04470

THEORY OF OPERATION

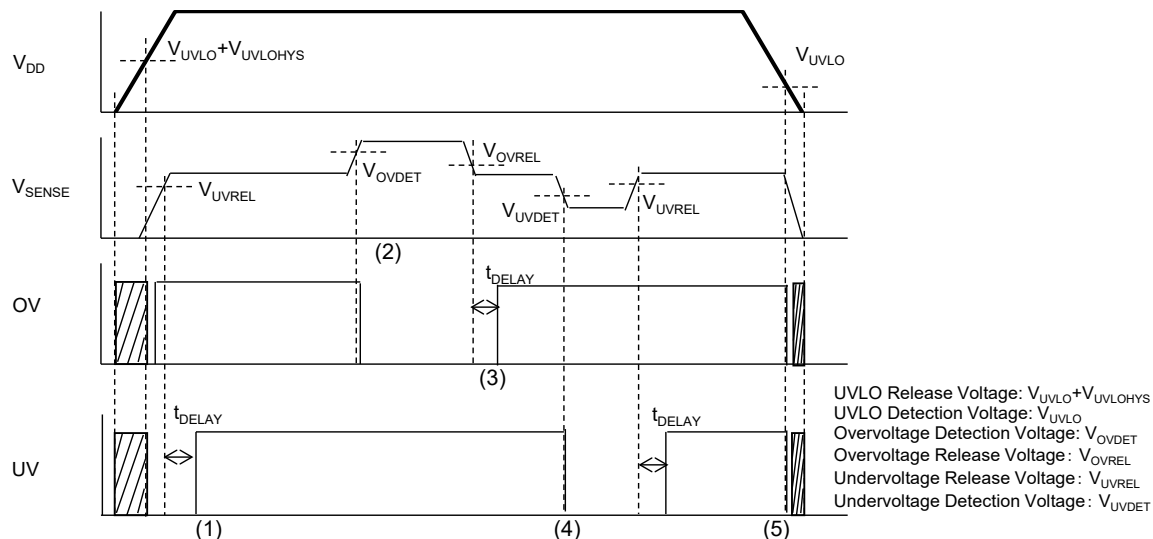

R3152N Timing Chart

- (1) When the SENSE pin voltage (V_{SENSE}) exceeded the undervoltage release voltage (V_{UVREL}), the UV pin output becomes “High” after the release delay time (t_{DELAY}).
- (2) When V_{SENSE} exceeded the overvoltage detection voltage (V_{OVDET}) by increasing in voltage, the OV pin output becomes “Low” after the detection delay time (Typ.10 μ s) and enters the overvoltage detecting state.
- (3) When V_{SENSE} decreases less than the overvoltage release voltage (V_{OVREL}), the OV pin output becomes “High” after the release delay time (t_{DELAY}).
- (4) When V_{SENSE} decreases less than the undervoltage detection voltage (V_{UVDET}), the UV pin output becomes “Low” after the detection delay time (Typ.10 μ s).
- (5) When the VDD pin voltage (V_{DD}) decreases less than the UVLO detection voltage (V_{UVLO}), the OV and UV pins output become “Low”.

Note: A certain tilting angle of power supply voltage of the R3152NxxxB may cause chattering at detection or at release. To prevent the occurrence of chattering, connect a 10-nF or more capacitor to the CD pin.

Delay in Operation and Delay Time (t_{DELAY})

At Undervoltage Detection

When supplying a voltage higher than the undervoltage release voltage (V_{UVREL}) to the SENSE pin, a charging to an external capacitor starts and the CD pin voltage (V_{CD}) increases. The UV pin voltage (V_{UV}) maintains “Low” until V_{CD} reaches the CD pin threshold voltage (V_{TCD}). When V_{CD} exceeds V_{TCD} , V_{UV} is inverted from “Low” to “High”. The release delay time (t_{DELAY}) is the period from the SENSE pin voltage (V_{SENSE}) exceeds V_{UVREL} to a rising edge of V_{UV} . When the output voltage turns from “Low” to “High”, a charge carrier of the external capacitor starts discharging. When the voltage lower than V_{UV} is supplied to the SENSE pin, the detection delay time (t_{PHL}), which is the period that V_{UV} is inverted from “High” to “Low”, remains constant independent of the external capacitor.

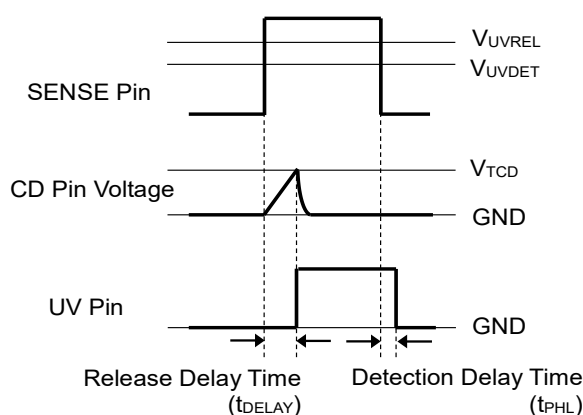

Undervoltage Release Delay Timing Diagram

Calculation of Release Delay Time (t_{DELAY})

The following equation can calculate a typical value of the release delay time (t_{DELAY}) with using the external capacitor (C_{D}).

$$t_{\text{DELAY}} (\text{s}) = 0.73 \times C_{\text{D}} (\text{F}) / (1.5 \times 10^{-6})$$

t_{DELAY} is the period from supplying a pulse voltage of 1.0 V \rightarrow ($V_{\text{UVDET}} + 1.0$ V) to the SENSE pin to the UV pins reached 2.5 V.

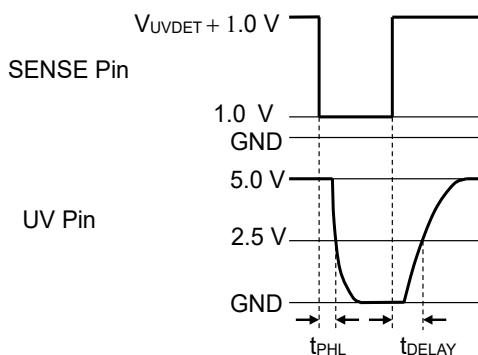

At Overvoltage Detection

When supplying a voltage lower than the overvoltage release voltage (V_{OVREL}) to the SENSE pin, a charging to an external capacitor starts and the CD pin voltage (V_{CD}) increases. The OV pin voltage (V_{OV}) maintains “Low” until V_{CD} reaches the CD pin threshold voltage (V_{TCD}). When V_{CD} exceeds V_{TCD} , V_{OV} is inverted from “Low” to “High”. The release delay time (t_{DELAY}) is the period from the SENSE pin voltage (V_{SENSE}) falls below V_{OVREL} to a rising edge of V_{OV} . When the output voltage turns from “Low” to “High”, a charge carrier of the external capacitor starts discharging. When the voltage higher than V_{OV} is supplied to the SENSE pin, the detection delay time (t_{PHL}), which is the period that V_{OV} is inverted from “High” to “Low”, remains constant independent of the external capacitor.

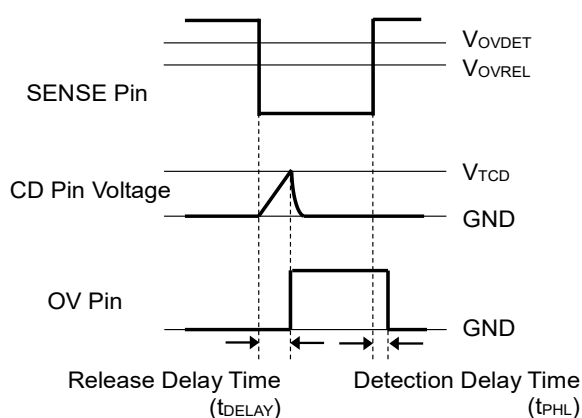

Overvoltage Release Delay Timing Diagram

Calculation of Release Delay Time (t_{DELAY})

The following equation can calculate a typical value of the release delay time (t_{DELAY}) with using the external capacitor (C_D).

$$t_{DELAY} \text{ (s)} = 0.73 \times C_D \text{ (F)} / (1.5 \times 10^{-6})$$

t_{DELAY} is the period from supplying a pulse voltage of $1.0 \text{ V} \rightarrow (V_{OVREL}) + 1.0 \text{ V}$ to the SENSE pin to the OV pin reached 2.5 V after the OV pin is pulled up to 5 V by connecting with a resistor of $100 \text{ k}\Omega$.

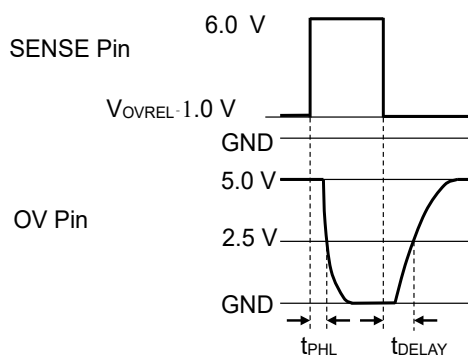

APPLICATION INFORMATION

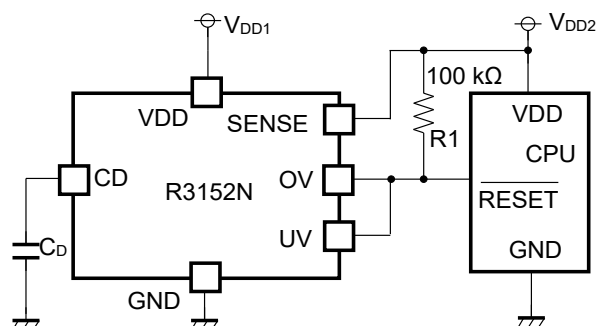

R3152N Typical Application Circuit

Recommended External Components

Symbol	Description
C_D	A capacitor corresponding to setting of Release Delay Time is required. Refer to "Delay in Operation and Released Delay Time (t_{DELAY})" in Operation Description for details.
R1	A resistor is required to set with consideration of the output current at Nch. driver's ON and the leakage current at Nch. driver's OFF. Refer to "Electrical Characteristic" for details – provided the evaluation result with using a resistor of 100kΩ.

TYPICAL CHARACTERISTICS

Typical Characteristics are intended to be used as reference data, they are not guaranteed.

1) Load Dump

$V_{UVSET} = 3.0\text{ V}$, $V_{OVSET} = 3.6\text{ V}$, $V_{SENSE} = 3.3\text{ V}$, Pulled-up to 5.0 V

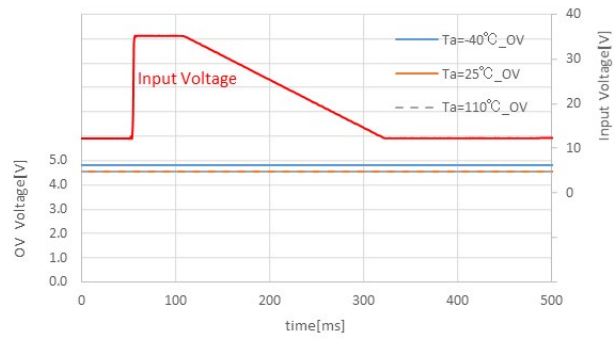
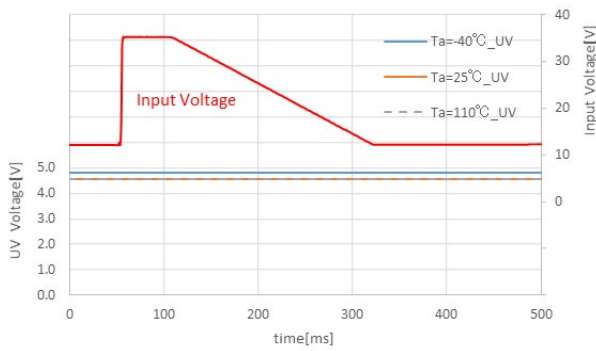

2) Cranking

$V_{UVSET} = 3.0\text{ V}$, $V_{OVSET} = 3.6\text{ V}$, $V_{SENSE} = 3.3\text{ V}$, Pulled-up to 5.0 V

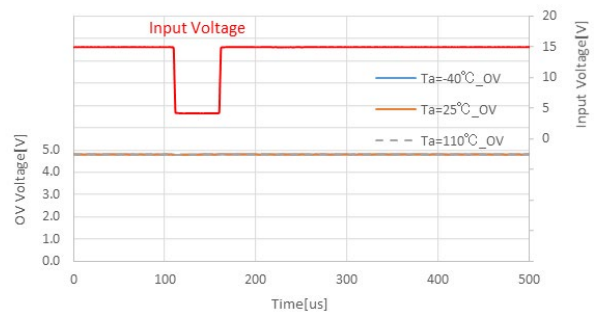
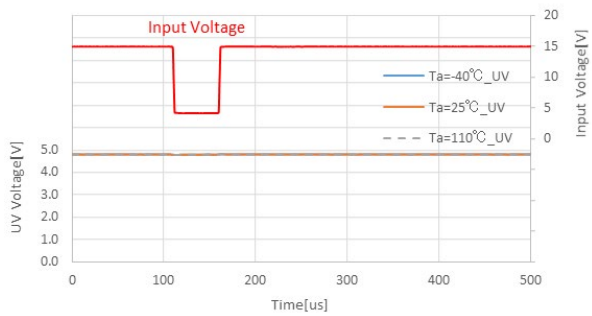

3) Supply Current vs. V_{DD}

$V_{UVSET} = 1.6\text{ V}$, $V_{OVSET} = 2.0\text{ V}$

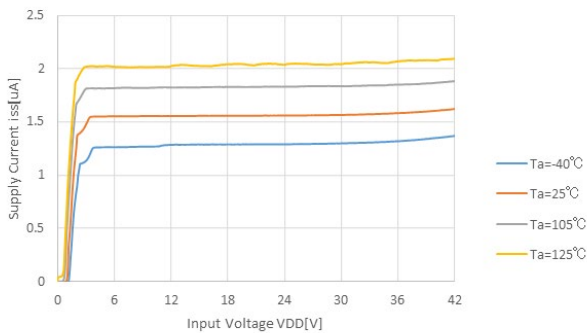

$V_{UVSET} = 3.0\text{ V}$, $V_{OVSET} = 3.6\text{ V}$

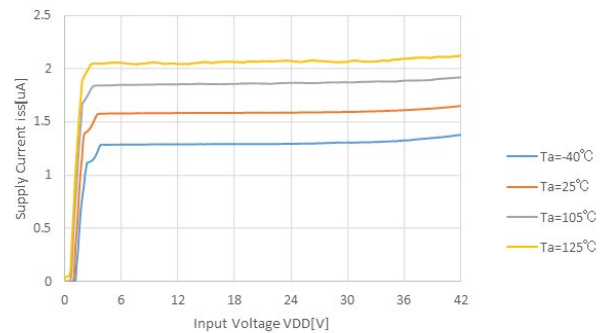

$V_{UVSET} = 4.7\text{ V}$, $V_{OVSET} = 5.3\text{ V}$

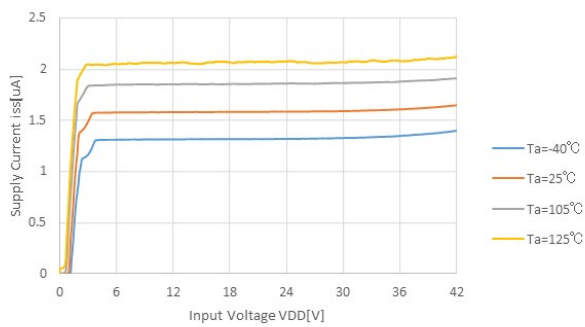

4) Supply Current vs. V_{SENSE}

$V_{UVSET} = 1.6\text{ V}$, $V_{OVSET} = 2.0\text{ V}$

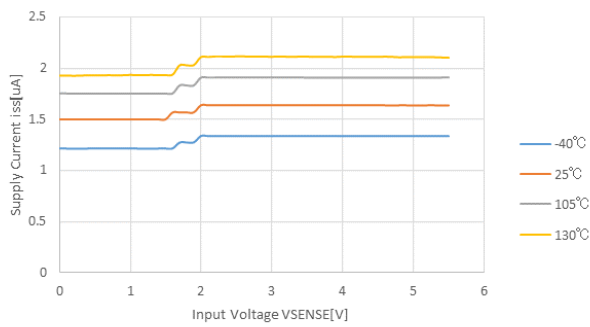

$V_{UVSET} = 3.0\text{ V}$, $V_{OVSET} = 3.6\text{ V}$

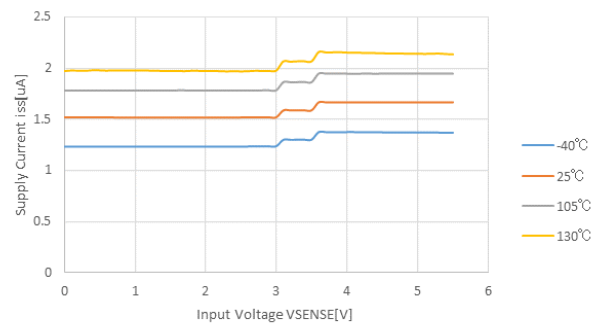

$V_{UVSET} = 4.7\text{ V}$, $V_{OVSET} = 5.3\text{ V}$

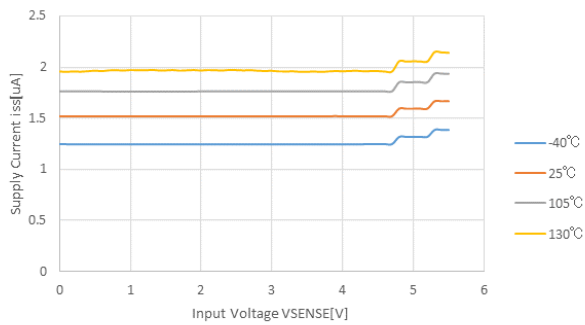

5) UV/OV Detection Voltage vs. Ambient Temperature

$V_{UVSET} = 1.6\text{ V}$, $V_{OVSET} = 2.0\text{ V}$

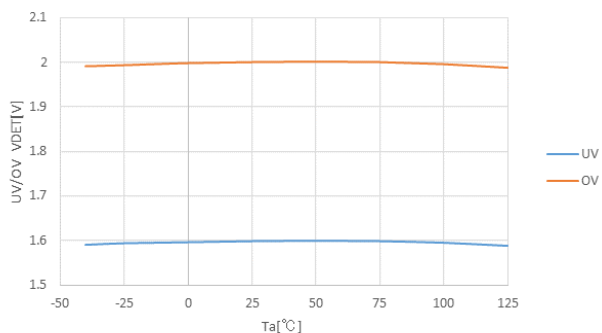

$V_{UVSET} = 3.0\text{ V}$, $V_{OVSET} = 3.6\text{ V}$

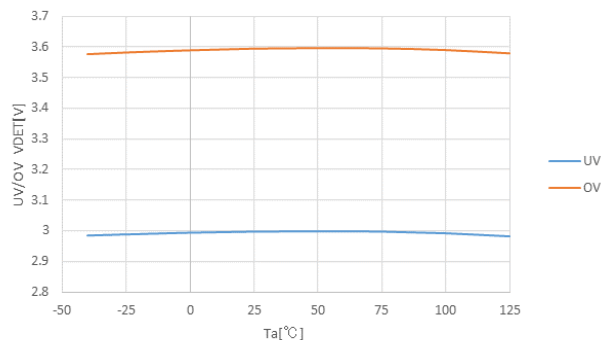

$V_{UVSET} = 4.7\text{ V}$, $V_{OVSET} = 5.3\text{ V}$

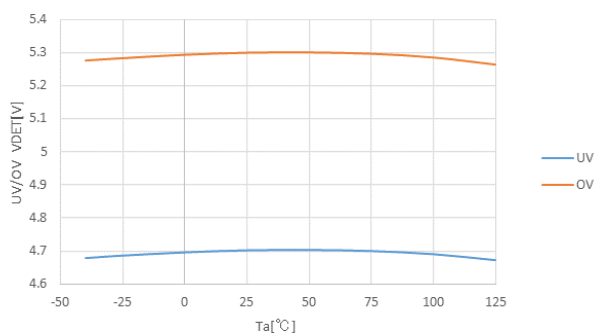

6) UV/OV Release Voltage vs. Ambient Temperature

$V_{UVSET} = 1.6\text{ V}$, $V_{OVSET} = 2.0\text{ V}$

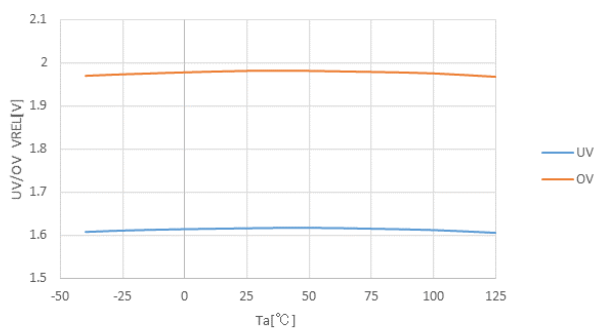

$V_{UVSET} = 3.0\text{ V}$, $V_{OVSET} = 3.6\text{ V}$

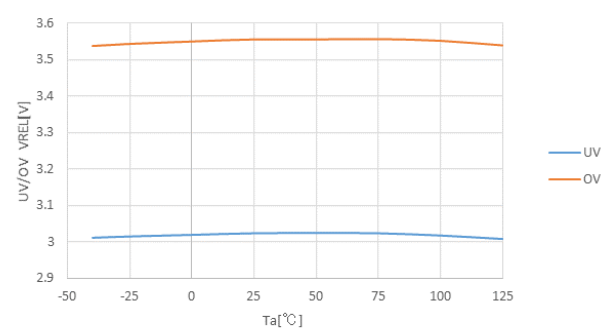

$V_{UVSET} = 4.7\text{ V}$, $V_{OVSET} = 5.3\text{ V}$

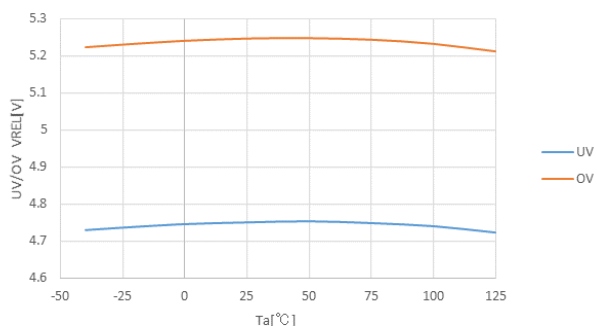

7) UV/OV Detection Voltage vs. V_{DD}

$V_{UVSET} = 1.6\text{ V}$, $V_{OVSET} = 2.0\text{ V}$

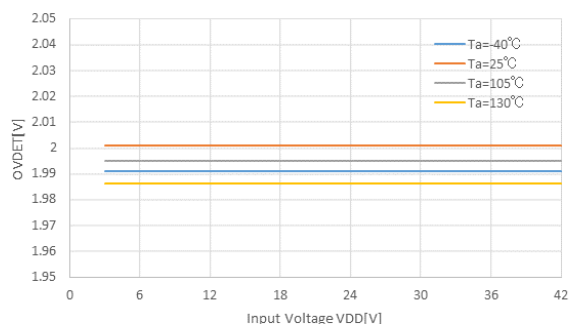
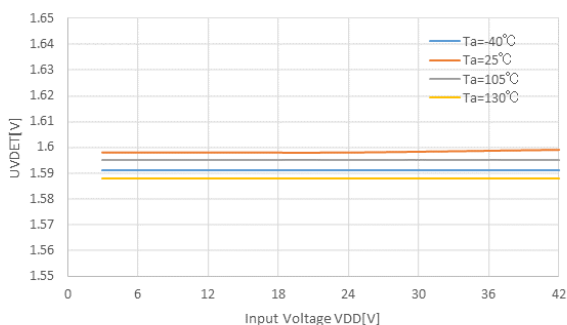

$V_{UVSET} = 3.0\text{ V}$, $V_{OVSET} = 3.6\text{ V}$

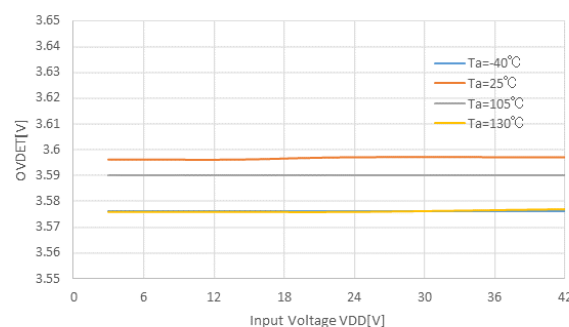
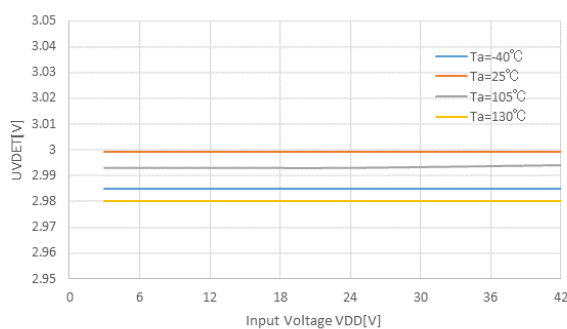

$V_{UVSET} = 4.7\text{ V}$, $V_{OVSET} = 5.3\text{ V}$

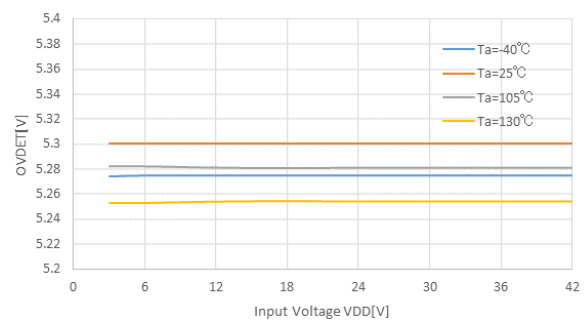
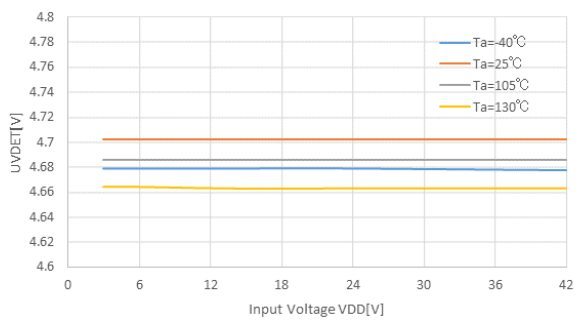

8) UV/OV Release Voltage vs. VDD

$V_{UVSET} = 1.6\text{ V}$, $V_{OVSET} = 2.0\text{ V}$

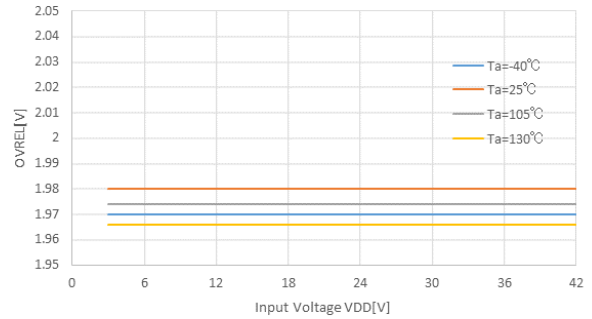
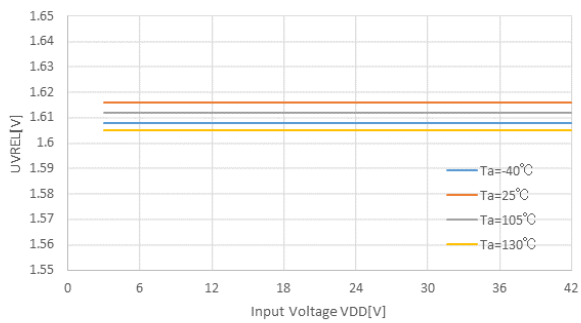

$V_{UVSET} = 3.0\text{ V}$, $V_{OVSET} = 3.6\text{ V}$

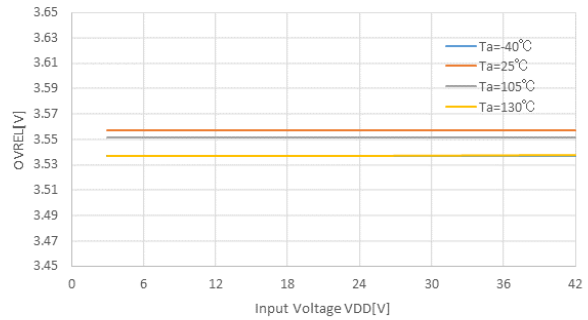
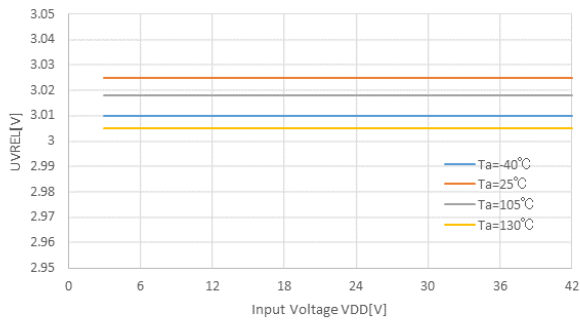

$V_{UVSET} = 4.7\text{ V}$, $V_{OVSET} = 5.3\text{ V}$

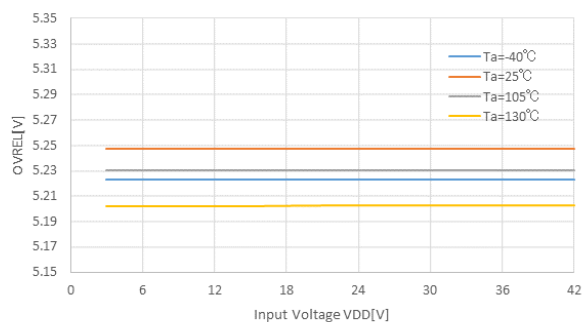
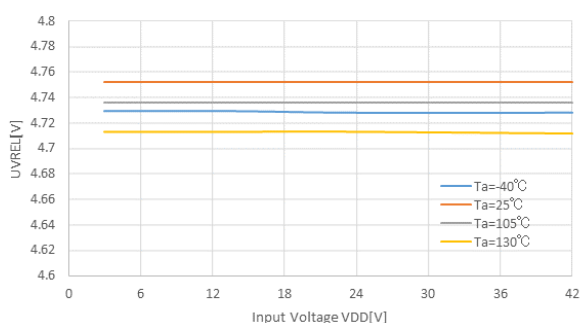

9) UV/OV Voltage vs. V_{DD} ($T_a = 25^\circ\text{C}$)

$V_{UVSET} = 1.6\text{ V}$, $V_{OVSET} = 2.0\text{ V}$, Pulled-up to 5.0 V

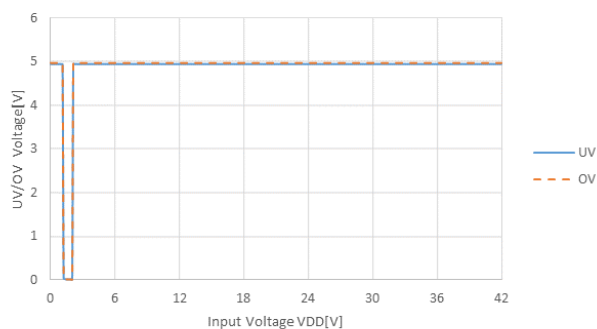

$V_{UVSET} = 4.7\text{ V}$, $V_{OVSET} = 5.3\text{ V}$, Pulled-up to 5.0 V

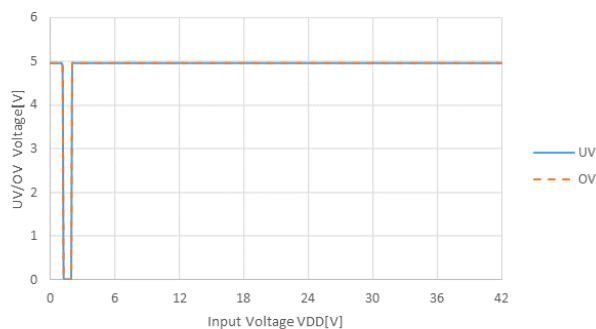

10) UV/OV Voltage vs. V_{SENSE} ($T_a = 25^\circ\text{C}$)

$V_{UVSET} = 1.6\text{ V}$, $V_{OVSET} = 2.0\text{ V}$, Pulled-up to 5.0 V

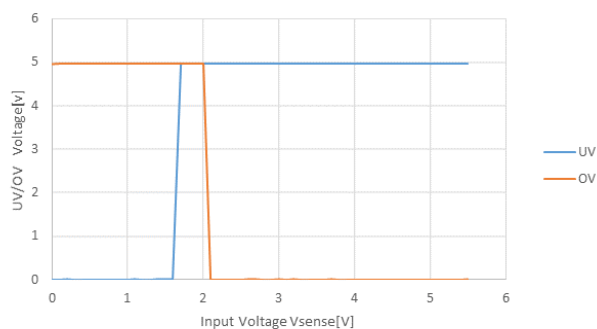

$V_{UVSET} = 4.7\text{ V}$, $V_{OVSET} = 5.3\text{ V}$, Pulled-up to 5.0 V

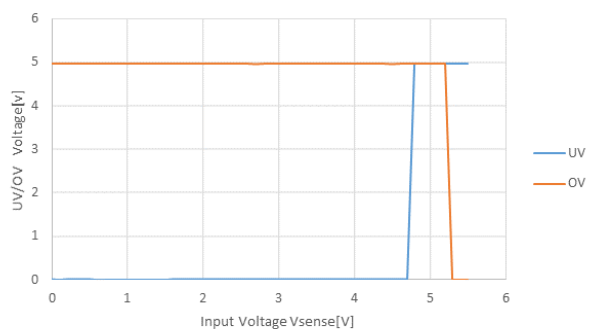

11) Driver Output Current vs. V_{DD}

V_{UVSET} = 4.7 V, V_{OVSET} = 5.3 V

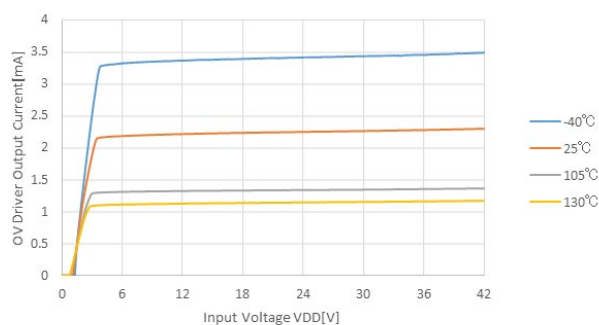
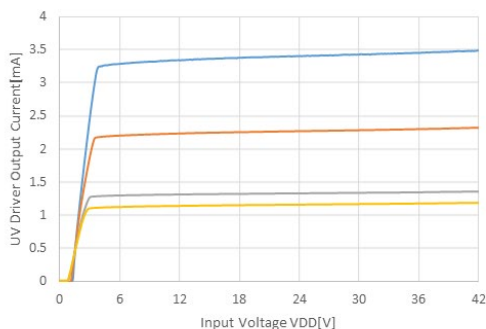

12) Driver Output Current vs. V_{DS} (Ta = 25°C)

V_{UVSET} = 1.6 V, V_{OVSET} = 2.0 V

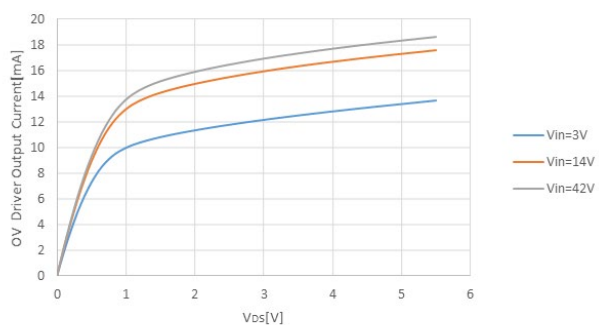
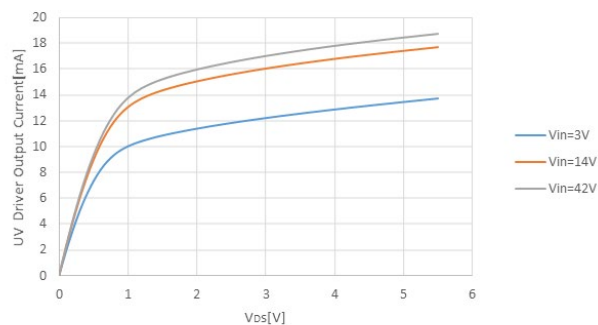

V_{UVSET} = 4.7 V, V_{OVSET} = 5.3 V

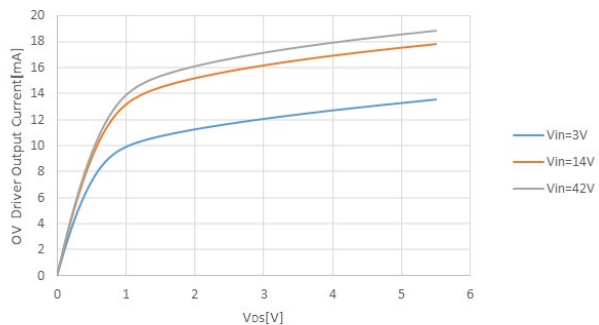
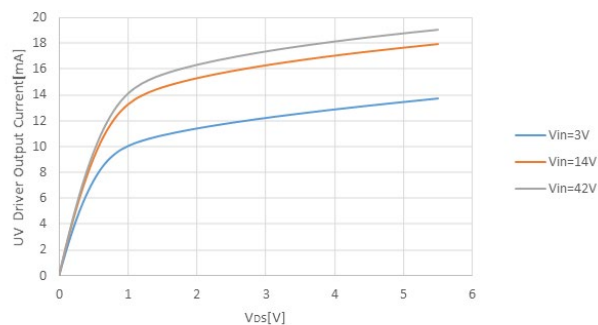

13) Release Delay Time vs. Ambient Temperature

$V_{UVSET} = 4.7\text{ V}$, $V_{OVSET} = 5.3\text{ V}$

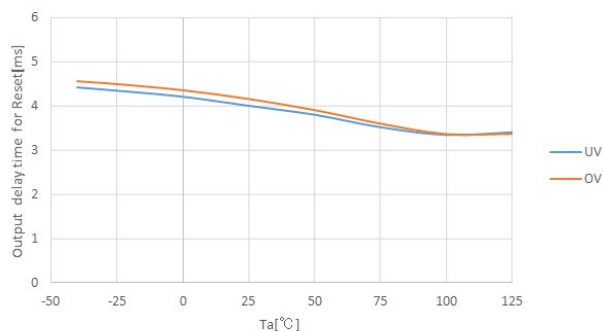

14) Release Delay Time vs. V_{DD}

$V_{UVSET} = 4.7\text{ V}$, $V_{OVSET} = 5.3\text{ V}$

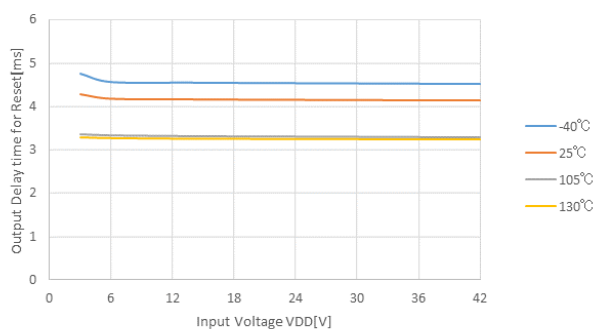
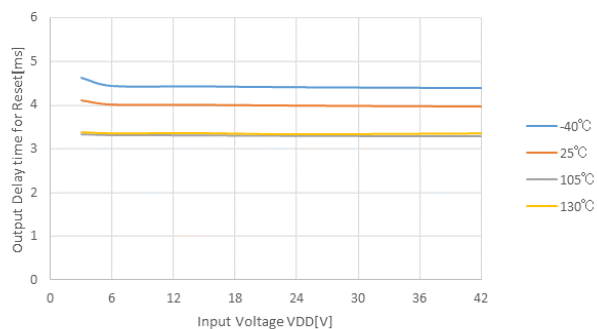

15) Detection / Release Delay Time vs. External Capacitor for CD Pin

$V_{UVSET} = 4.7\text{ V}$, $V_{OVSET} = 5.3\text{ V}$

(Ta = 25°C)

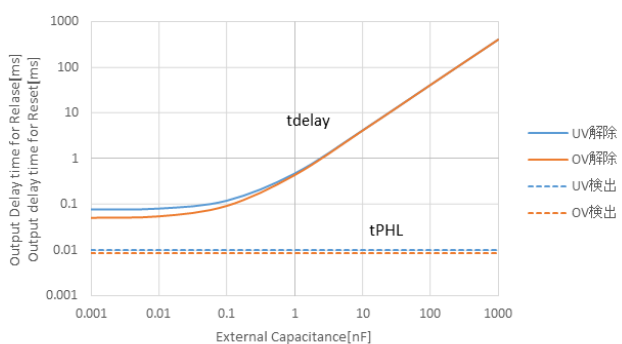

16) SENSE Pulse Width vs. Over Drive Voltage

(Ta = 25°C)

Release State Threshold Pulse

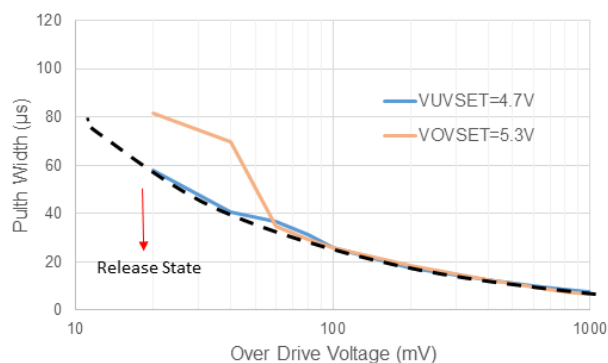

The power dissipation of the package is dependent on PCB material, layout, and environmental conditions. The following measurement conditions are based on JEDEC STD. 51-7.

Measurement Conditions

Item	Measurement Conditions
Environment	Mounting on Board (Wind Velocity = 0 m/s)
Board Material	Glass Cloth Epoxy Plastic (Four-Layer Board)
Board Dimensions	76.2 mm × 114.3 mm × 0.8 mm
Copper Ratio	Outer Layer (First Layer): Less than 95% of 50 mm Square Inner Layers (Second and Third Layers): Approx. 100% of 50 mm Square Outer Layer (Fourth Layer): Approx. 100% of 50 mm Square
Through-holes	φ 0.3 mm × 7 pcs

Measurement Result

(Ta = 25°C, Tjmax = 150°C)

Item	Measurement Result
Power Dissipation	830 mW
Thermal Resistance (θja)	θja = 150°C/W
Thermal Characterization Parameter (ψjt)	ψjt = 51°C/W

θja: Junction-to-Ambient Thermal Resistance

ψjt: Junction-to-Top Thermal Characterization Parameter

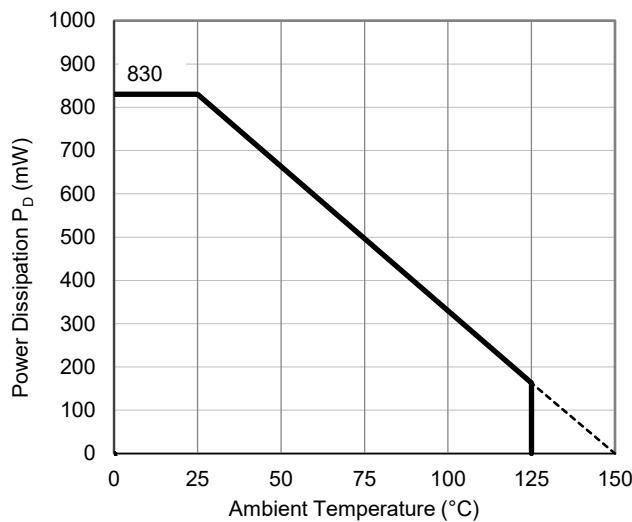

Power Dissipation vs. Ambient Temperature

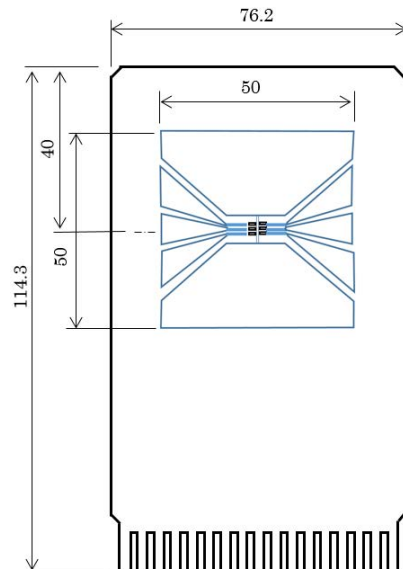

Measurement Board Pattern

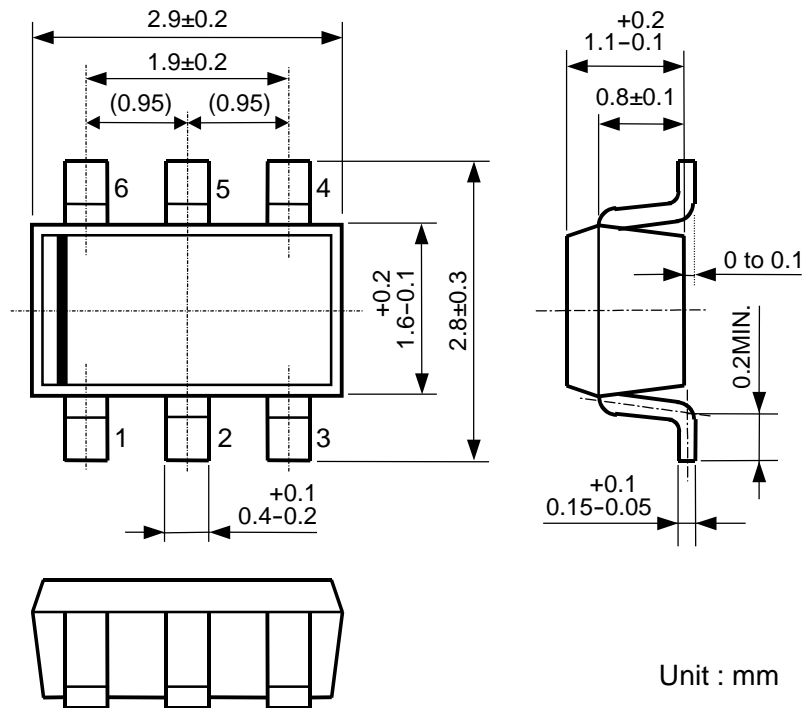

SOT-23-6 Package Dimensions (Unit: mm)

①②: Product Code ... Refer to *Part Marking List*

③④: Lot Number ... Alphanumeric Serial Number

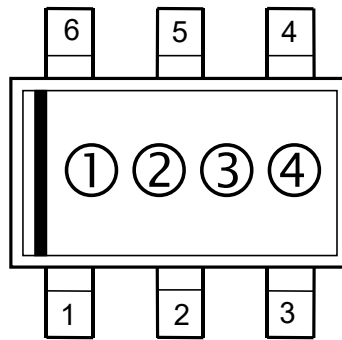

SOT-23-6 Part Markings

NOTICE

There can be variation in the marking when different AOI (Automated Optical Inspection) equipment is used. In the case of recognizing the marking characteristic with AOI, please contact our sales or distributor before attempting to use AOI.

R3152NxxxA Part Marking List

Product Name	①②
R3152N001A	GA
R3152N002A	GB
R3152N004A	GD
R3152N005A	GE
R3152N013A	GN
R3152N014A	GP
R3152N015A	GR
R3152N017A	GT
R3152N020A	GW
R3152N203A	G1
R3152N204A	G2
R3152N103A	G3
R3152N104A	G7
R3152N105A	G8
R3152N106A	G9

R3152NxxxB Part Marking List

Product Name	①②
R3152N003B	HC
R3152N201B	HX
R3152N101B	HY
R3152N102B	HZ

1. The products and the product specifications described in this document are subject to change or discontinuation of production without notice for reasons such as improvement. Therefore, before deciding to use the products, please refer to our sales representatives for the latest information thereon.
2. The materials in this document may not be copied or otherwise reproduced in whole or in part without the prior written consent of us.
3. This product and any technical information relating thereto are subject to complementary export controls (so-called KNOW controls) under the Foreign Exchange and Foreign Trade Law, and related politics ministerial ordinance of the law. (Note that the complementary export controls are inapplicable to any application-specific products, except rockets and pilotless aircraft, that are insusceptible to design or program changes.) Accordingly, when exporting or carrying abroad this product, follow the Foreign Exchange and Foreign Trade Control Law and its related regulations with respect to the complementary export controls.
4. The technical information described in this document shows typical characteristics and example application circuits for the products. The release of such information is not to be construed as a warranty of or a grant of license under our or any third party's intellectual property rights or any other rights.
5. The products listed in this document are intended and designed for automotive applications. Those customers intending to use a product in an application requiring extreme quality and reliability, for example, in a highly specific application where the failure or misoperation of the product could result in human injury or death should first contact us.
 - Aerospace Equipment
 - Equipment Used in the Deep Sea
 - Power Generator Control Equipment (nuclear, steam, hydraulic, etc.)
 - Life Maintenance Medical Equipment
 - Fire Alarms / Intruder Detectors
 - Vehicle Control Equipment (airplane, railroad, ship, etc.)
 - Various Safety Devices
 - Traffic control system
 - Combustion equipment

In case your company desires to use this product for any applications other than general electronic equipment mentioned above, make sure to contact our company in advance. Note that the important requirements mentioned in this section are not applicable to cases where operation requirements such as application conditions are confirmed by our company in writing after consultation with your company.

6. We are making our continuous effort to improve the quality and reliability of our products, but semiconductor products are likely to fail with certain probability. In order to prevent any injury to persons or damages to property resulting from such failure, customers should be careful enough to incorporate safety measures in their design, such as redundancy feature, fire containment feature and fail-safe feature. We do not assume any liability or responsibility for any loss or damage arising from misuse or inappropriate use of the products.
7. The products have been designed and tested to function within controlled environmental conditions. Do not use products under conditions that deviate from methods or applications specified in this datasheet. Failure to employ the products in the proper applications can lead to deterioration, destruction or failure of the products. We shall not be responsible for any bodily injury, fires or accident, property damage or any consequential damages resulting from misuse or misapplication of the products.
8. **Quality Warranty**
 - 8-1. **Quality Warranty Period**
In the case of a product purchased through an authorized distributor or directly from us, the warranty period for this product shall be one (1) year after delivery to your company. For defective products that occurred during this period, we will take the quality warranty measures described in section 8-2. However, if there is an agreement on the warranty period in the basic transaction agreement, quality assurance agreement, delivery specifications, etc., it shall be followed.
 - 8-2. **Quality Warranty Remedies**
When it has been proved defective due to manufacturing factors as a result of defect analysis by us, we will either deliver a substitute for the defective product or refund the purchase price of the defective product.
Note that such delivery or refund is sole and exclusive remedies to your company for the defective product.
 - 8-3. **Remedies after Quality Warranty Period**
With respect to any defect of this product found after the quality warranty period, the defect will be analyzed by us. On the basis of the defect analysis results, the scope and amounts of damage shall be determined by mutual agreement of both parties. Then we will deal with upper limit in Section 8-2. This provision is not intended to limit any legal rights of your company.
9. Anti-radiation design is not implemented in the products described in this document.
10. The X-ray exposure can influence functions and characteristics of the products. Confirm the product functions and characteristics in the evaluation stage.
11. WLCSP products should be used in light shielded environments. The light exposure can influence functions and characteristics of the products under operation or storage.
12. Warning for handling Gallium and Arsenic (GaAs) products (Applying to GaAs MMIC, Photo Reflector). These products use Gallium (Ga) and Arsenic (As) which are specified as poisonous chemicals by law. For the prevention of a hazard, do not burn, destroy, or process chemically to make them as gas or power. When the product is disposed of, please follow the related regulation and do not mix this with general industrial waste or household waste.
13. Please contact our sales representatives should you have any questions or comments concerning the products or the technical information.



Nisshinbo Micro Devices Inc.

Official website

<https://www.nisshinbo-microdevices.co.jp/en/>

Purchase information

<https://www.nisshinbo-microdevices.co.jp/en/buy/>