

NOTE:

1. MATERIAL:  
HSG & CAP - NYLON, GLASS-FILLED, UL 94V-0, COLOUR BLACK  
PIN - 0.50 SQ. PHOSPHOR BRONZE
2. PLATING OPTION:  
1: 0.38µm MIN. GOLD PLATE AT CONTACT AREA, TIN PLATE AT SOLDER AREA, BOTH OVER NICKEL UNDERPLATE  
2: 0.05-0.25µm MIN. GOLD PLATE AT CONTACT AREA, TIN PLATE AT SOLDER AREA, BOTH OVER NICKEL UNDERPLATE
3. PIN PUSHOUT FORCE: 1kg MIN. IN EITHER DIRECTION.
4. PRODUCT SPEC PS-87761-100 APPLIES.
5. BEND DEPRESSION IS ACCEPTABLE SO LONG AS IT DOES NOT AFFECT THE OVERALL COPLANARITY OF TAIL.
6. COPLANARITY IS TO BE MEASURED BY RESTING THE SOLDER TAIL ON A GAUGE SURFACE.
7. CAP TO BE LOCATED AS CENTRAL OF PART AS POSSIBLE  
TOP SURFACE OF CAP TO BE FLAT FOR THE PURPOSE OF PICK & PLACE BY VACCUM SUCTION NOZZLE.
8. FOR ILLUSTRATION PURPOSES, 10CKT IS SHOWN (WITH TAPE & REEL ON 2ND SHEET). SHT 3 INDICATES THE TYPE OF EMBOSSED USED IN GENERAL.
9. TUBE LENGTH IS 560MM REF STANDARD.
10. RECOMMENDED PCB BOARD THK IS 1.60±0.10 MM.

THIS DRAWING CONTAINS INFORMATION THAT IS PROPRIETARY TO MOLEX ELECTRONIC TECHNOLOGIES, LLC AND SHOULD NOT BE USED WITHOUT WRITTEN PERMISSION									
DIMENSION UNITS		SCALE		CURRENT REV DESC:				<b>molex</b>	
mm		NTS							
GENERAL TOLERANCES (UNLESS SPECIFIED)				EC NO: 699037		CUSTOMER		CUSTOMER	
				DRWN: DANUSA		MGRID, 2MM DUAL ROW HDR WITH PEG, SMT			
				CHK'D: DANUSA		PRODUCT CUSTOMER DRAWING			
				APPR: MRAMAKRISHNA		DOCUMENT NUMBER		DOC TYPE DOC PART REVISION	
				INITIAL REVISION:		SD-87759-208		PSD 001 D7	
				DRWN: KSEE		SERIES		SHEET NUMBER	
				APPR: MLONG		87759		1 OF 4	
DRAFT WHERE APPLICABLE MUST REMAIN WITHIN DIMENSIONS				THIRD ANGLE PROJECTION		DRAWING		MATERIAL NUMBER	
				A3-SIZE		SEE TABLE		GENERAL MARKET	

CAP TYPE	D
C1	5.20
C2	4.60

EMBOSED TYPE "A"  
PART WITH CAP IN TAPE & REEL ORIENTATION

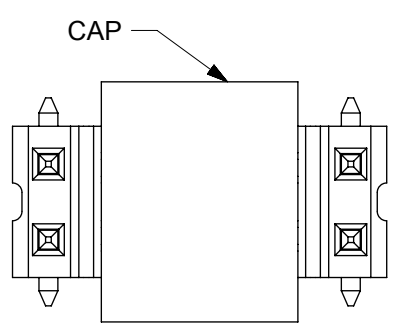
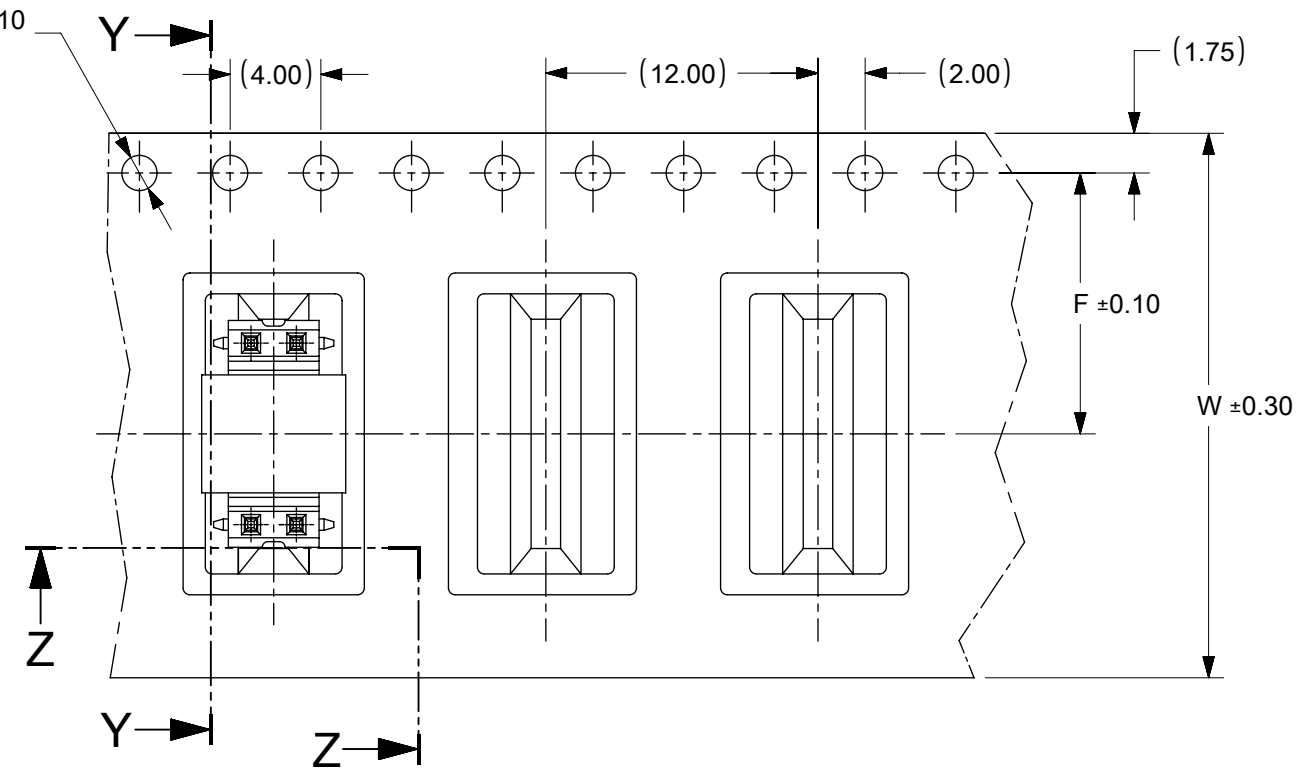
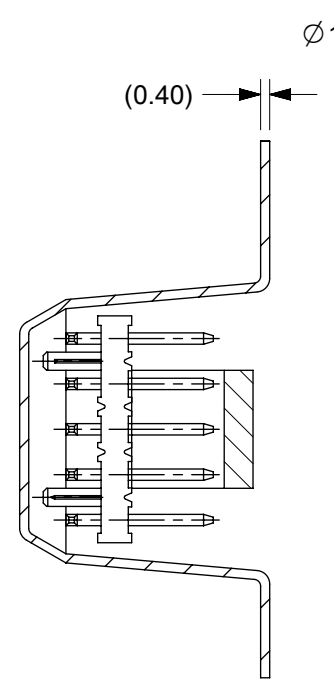
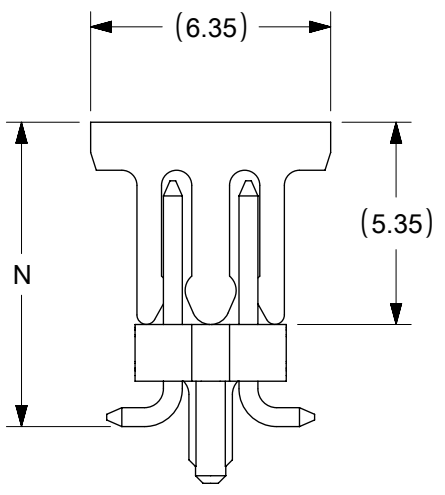
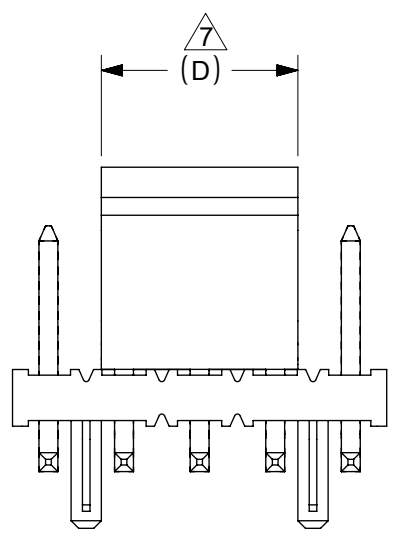

SECTION Y-Y

CUSTOMER  
PULL OUT DIRECTION

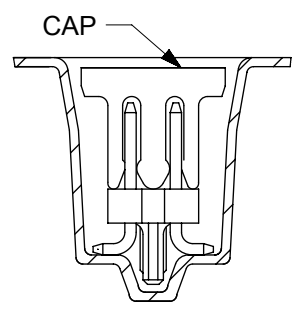

SECTION Z-Z

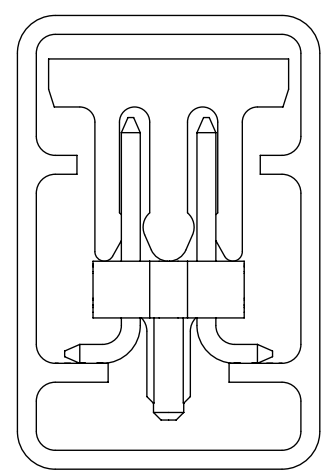

PART WITH CAP IN  
TUBE ORIENTATION

THIS DRAWING CONTAINS INFORMATION THAT IS PROPRIETARY TO MOLEX ELECTRONIC TECHNOLOGIES, LLC AND SHOULD NOT BE USED WITHOUT WRITTEN PERMISSION									
DIMENSION UNITS		SCALE		CURRENT REV DESC:				<b>molex</b>	
mm		NTS							
GENERAL TOLERANCES (UNLESS SPECIFIED)				EC NO: 699037		CUSTOMER		CUSTOMER	
		MM	INCH	DRWN: DANUSA 2021/11/26		MGRID, 2MM DUAL ROW HDR WITH PEG, SMT			
4 PLACES ±				CHK'D: DANUSA 2022/03/10		PRODUCT CUSTOMER DRAWING			
3 PLACES ±				APPR: MRAMAKRISHNA 2022/03/10					
2 PLACES ± 0.2				INITIAL REVISION:		DOCUMENT NUMBER		DOC TYPE	DOC PART
1 PLACE ±				DRWN: KSEE 2003/12/22		SD-87759-208		PSD	001
0 PLACES ±				APPR: MLONG 2009/12/17					D7
ANGULAR TOL ± 3.0°				DRAFT WHERE APPLICABLE MUST REMAIN WITHIN DIMENSIONS		THIRD ANGLE PROJECTION	DRAWING	SERIES	MATERIAL NUMBER
							A3-SIZE	87759	SEE TABLE
									CUSTOMER
									GENERAL MARKET
									SHEET NUMBER
									2 OF 4

EMBOSED TYPE "B"

PART WITH CAP IN  
TAPE & REEL ORIENTATION

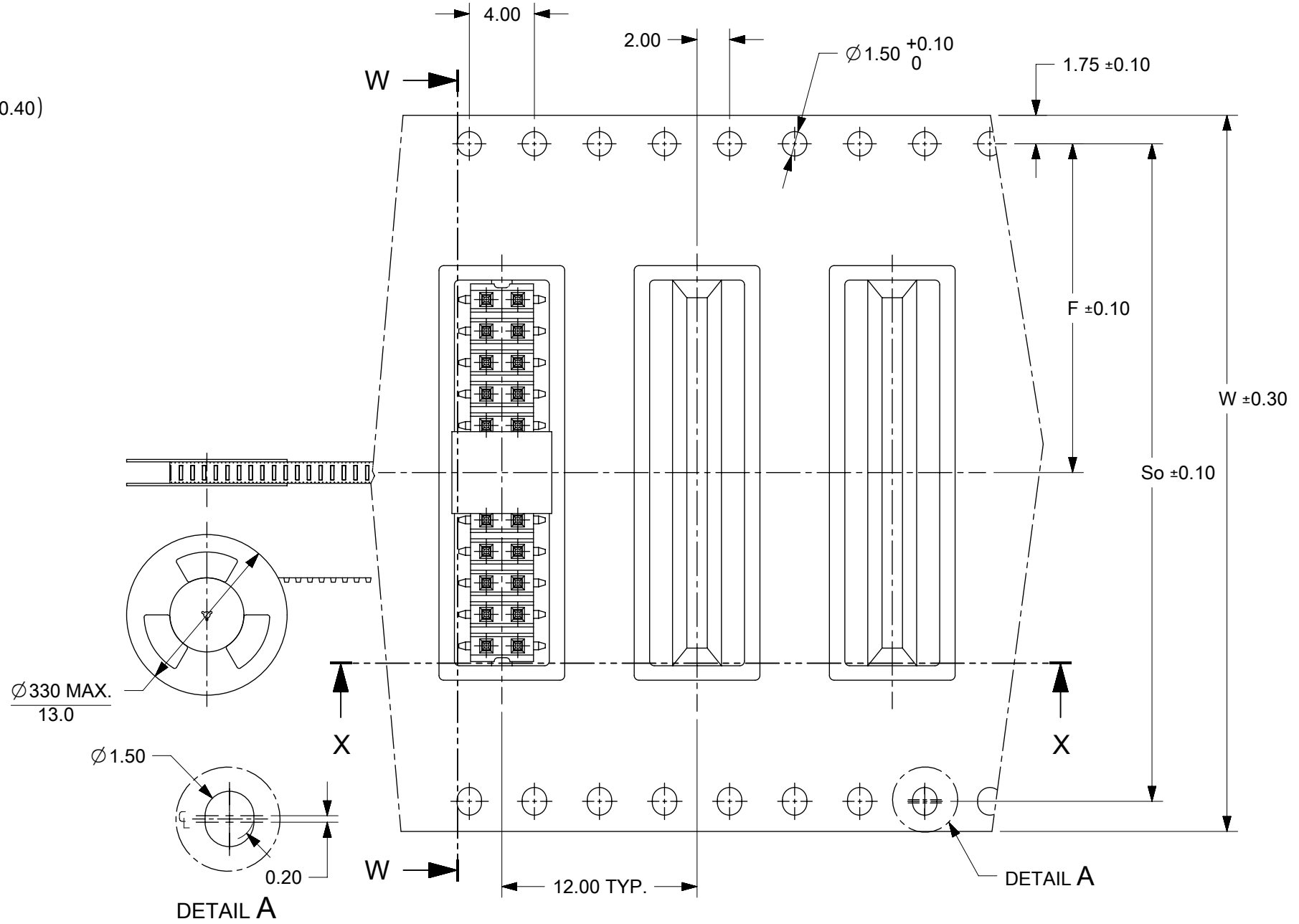
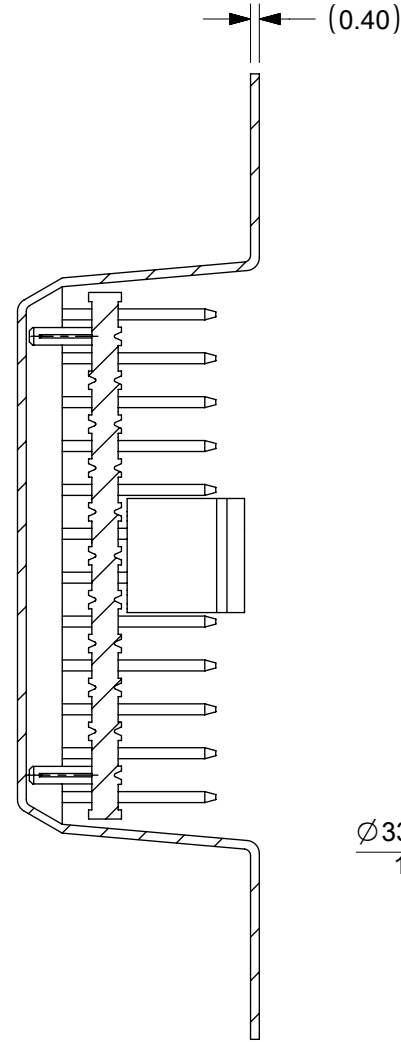

$\varnothing 330$  MAX.  
13.0

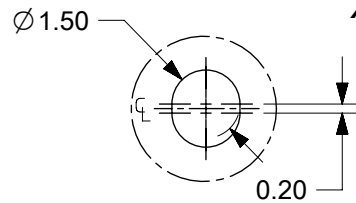

NOTES:

1. LEADER AND TRAILER TAPE

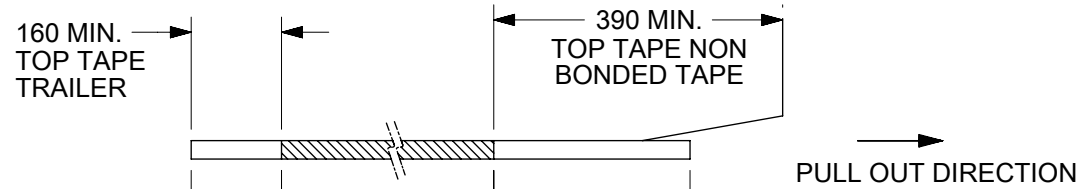

2. PEELING OFF FORCE OF THE TOP TAPE: 20 - 80gf.  
(PEELING DIRECTION AS SHOWN IN FOLLOWING FIGURE)





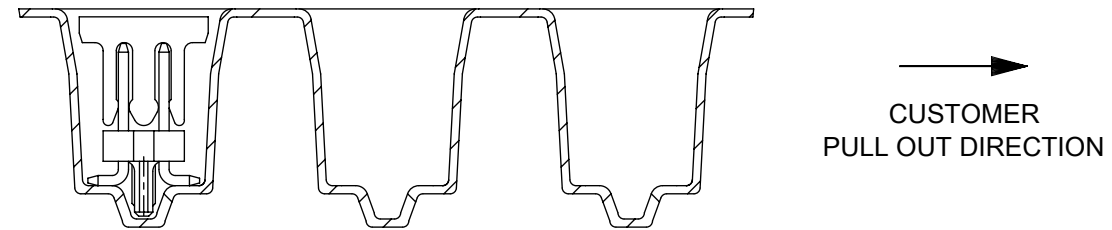

3. TAPE AND REEL SPECIFICATION IS AS PER EIA-481.  
4. TAPE & REEL QUANTITY = 500 PCS/REEL  
5. THE TAPE IS TREATED FOR ANTI-STATIC

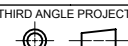

THIS DRAWING CONTAINS INFORMATION THAT IS PROPRIETARY TO MOLEX ELECTRONIC TECHNOLOGIES, LLC AND SHOULD NOT BE USED WITHOUT WRITTEN PERMISSION									
DIMENSION UNITS		SCALE		CURRENT REV DESC:					
mm		NTS		<b>molex</b> CUSTOM HEADER MGRID, 2MM DUAL ROW HDR WITH PEG, SMT PRODUCT CUSTOMER DRAWING DOCUMENT NUMBER: SD-87759-208 DOC TYPE: PSD DOC PART: 001 REVISION: D7 MATERIAL NUMBER: SEE TABLE CUSTOMER: GENERAL MARKET SHEET NUMBER: 3 OF 4					
GENERAL TOLERANCES (UNLESS SPECIFIED)									
		MM	INCH						
4 PLACES	±								
3 PLACES	±								
2 PLACES	±	0.2	±						
1 PLACE	±								
0 PLACES	±								
ANGULAR TOL ± 3.0°				EC NO: 699037 DRWN: DANUSA 2021/11/26 CHK'D: DANUSA 2022/03/10 APPR: MRAMAKRISHNA 2022/03/10 INITIAL REVISION: DRWN: KSEE 2003/12/22 APPR: MLONG 2009/12/17					
DRAFT WHERE APPLICABLE MUST REMAIN WITHIN DIMENSIONS				THIRD ANGLE PROJECTION		DRAWING		SERIES	
						A3-SIZE		87759	

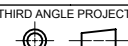
9		8		7		6		5		4		3		2		1	
PART NUMBER WITH CAP IN TUBE		PART NUMBER WITH CAP IN TAPE AND REEL.		PART NUMBER WITHOUT CAP IN TAPE AND REEL.		CKT SIZE	A	B	C	M	N	F	So	W	EMBOSSSED TYPE	CAP TYPE	PLATING OPTION
E		87759-0876	87759-7626			08	7.90	6.00	4.00	3.80	8.05	11.50	-	24.00	A	C1	1
		87759-5276	87759-7648			08	7.90	6.00	4.00	8.80	13.00	11.50	-	24.00	A	C2	
		87759-1076	87759-7627			10	9.90	8.00	6.00	3.80	8.05	11.50	-	24.00	A	C1	
		87759-1276	87759-7628	87759-7649	(D7)	12	11.90	10.00	8.00	3.80	8.05	11.50	-	24.00	A		
		87759-1476	87759-7629			14	13.90	12.00	10.00	3.80	8.05	11.50	-	24.00	A	C1	
		87759-1676	87759-7630			16	15.90	14.00	12.00	3.80	8.05	14.20	28.40	32.00	B	C1	
		87759-1876	87759-7631	87759-7650	(D7)	18	17.90	16.00	14.00	3.80	8.05	14.20	28.40	32.00	B	C1	
		87759-2076	87759-7632			20	19.90	18.00	16.00	3.80	8.05	20.20	40.40	44.00	B	C1	
		87759-2276	87759-7633			22	21.90	20.00	18.00	3.80	8.05	20.20	40.40	44.00	B	C1	
		87759-2476	87759-7634			24	23.90	22.00	20.00	3.80	8.05	20.20	40.40	44.00	B	C1	
		87759-2676	87759-7635			26	25.90	24.00	22.00	3.80	8.05	20.20	40.40	44.00	B	C1	
D		87759-2876	87759-7636			28	27.90	26.00	24.00	3.80	8.05	20.20	40.40	44.00	B	C1	
		87759-3076	87759-7637			30	29.90	28.00	26.00	3.80	8.05	20.20	40.40	44.00	B	C1	
		87759-3276	87759-7638			32	31.90	30.00	28.00	3.80	8.05	26.20	52.40	56.00	B	C1	
		87759-3476	87759-7639			34	33.90	32.00	30.00	3.80	8.05	26.20	52.40	56.00	B	C1	
		87759-3676	87759-7640			36	35.90	34.00	32.00	3.80	8.05	26.20	52.40	56.00	B	C1	
		87759-3876	87759-7641			38	37.90	36.00	34.00	3.80	8.05	26.20	52.40	56.00	B	C1	
		87759-4076	87759-7642			40	39.90	38.00	36.00	3.80	8.05	26.20	52.40	56.00	B	C1	
C		87759-4276	87759-7643			42	41.90	40.00	38.00	3.80	8.05	26.20	52.40	56.00	B	C1	
		87759-4476	87759-7644			44	43.90	42.00	40.00	3.80	8.05	26.20	52.40	56.00	B	C1	
		87759-4676	87759-7645			46	45.90	44.00	42.00	3.80	8.05	34.20	68.40	72.00	B	C1	
		87759-4876	87759-7646			48	47.90	46.00	44.00	3.80	8.05	34.20	68.40	72.00	B	C1	
		87759-5076	87759-7647			50	49.90	48.00	46.00	3.80	8.05	34.20	68.40	72.00	B	C1	

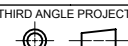
B																																																																																																																																																																																																																					
A																																																																																																																																																																																																																					
<table border="1"> <tr> <td colspan="16">THIS DRAWING CONTAINS INFORMATION THAT IS PROPRIETARY TO MOLEX ELECTRONIC TECHNOLOGIES, LLC AND SHOULD NOT BE USED WITHOUT WRITTEN PERMISSION</td> </tr> <tr> <td colspan="2">DIMENSION UNITS</td> <td colspan="2">SCALE</td> <td colspan="10">CURRENT REV DESC:</td> <td colspan="2" rowspan="2">  </td> </tr> <tr> <td colspan="2">mm</td> <td colspan="2">NTS</td> <td colspan="10"></td> </tr> <tr> <td colspan="4">GENERAL TOLERANCES (UNLESS SPECIFIED)</td> <td colspan="10">EC NO: 699037</td> <td colspan="2" rowspan="2">CUSTOM HEADER</td> </tr> <tr> <td colspan="4"></td> <td colspan="10">DRWN: DANUSA 2021/11/26</td> </tr> <tr> <td colspan="4"></td> <td colspan="10">CHK'D: DANUSA 2022/03/10</td> <td colspan="2" rowspan="2">PRODUCT CUSTOMER DRAWING</td> </tr> <tr> <td colspan="4"></td> <td colspan="10">APPR: MRAMAKRISHNA 2022/03/10</td> </tr> <tr> <td colspan="4"></td> <td colspan="10">INITIAL REVISION:</td> <td colspan="2" rowspan="2">DOCUMENT NUMBER</td> </tr> <tr> <td colspan="4"></td> <td colspan="10">DRWN: KSEE 2003/12/22</td> </tr> <tr> <td colspan="4"></td> <td colspan="10">APPR: MLONG 2009/12/17</td> <td colspan="2" rowspan="2">SD-87759-208</td> </tr> <tr> <td colspan="4"></td> <td colspan="10">ANGULAR TOL ± 3.0°</td> </tr> <tr> <td colspan="4">DRAFT WHERE APPLICABLE MUST REMAIN WITHIN DIMENSIONS</td> <td colspan="2">THIRD ANGLE PROJECTION</td> <td colspan="2">DRAWING</td> <td colspan="2">SERIES</td> <td colspan="2">MATERIAL NUMBER</td> <td colspan="2">CUSTOMER</td> <td colspan="2">SHEET NUMBER</td> </tr> <tr> <td colspan="4"></td> <td colspan="2">  </td> <td colspan="2">A3-SIZE</td> <td colspan="2">87759</td> <td colspan="2">SEE TABLE</td> <td colspan="2">GENERAL MARKET</td> <td colspan="2">4 OF 4</td> </tr> </table>																THIS DRAWING CONTAINS INFORMATION THAT IS PROPRIETARY TO MOLEX ELECTRONIC TECHNOLOGIES, LLC AND SHOULD NOT BE USED WITHOUT WRITTEN PERMISSION																DIMENSION UNITS		SCALE		CURRENT REV DESC:												mm		NTS												GENERAL TOLERANCES (UNLESS SPECIFIED)				EC NO: 699037										CUSTOM HEADER						DRWN: DANUSA 2021/11/26														CHK'D: DANUSA 2022/03/10										PRODUCT CUSTOMER DRAWING						APPR: MRAMAKRISHNA 2022/03/10														INITIAL REVISION:										DOCUMENT NUMBER						DRWN: KSEE 2003/12/22														APPR: MLONG 2009/12/17										SD-87759-208						ANGULAR TOL ± 3.0°										DRAFT WHERE APPLICABLE MUST REMAIN WITHIN DIMENSIONS				THIRD ANGLE PROJECTION		DRAWING		SERIES		MATERIAL NUMBER		CUSTOMER		SHEET NUMBER								A3-SIZE		87759		SEE TABLE		GENERAL MARKET		4 OF 4	
THIS DRAWING CONTAINS INFORMATION THAT IS PROPRIETARY TO MOLEX ELECTRONIC TECHNOLOGIES, LLC AND SHOULD NOT BE USED WITHOUT WRITTEN PERMISSION																																																																																																																																																																																																																					
DIMENSION UNITS		SCALE		CURRENT REV DESC:																																																																																																																																																																																																																	
mm		NTS																																																																																																																																																																																																																			
GENERAL TOLERANCES (UNLESS SPECIFIED)				EC NO: 699037										CUSTOM HEADER																																																																																																																																																																																																							
				DRWN: DANUSA 2021/11/26																																																																																																																																																																																																																	
				CHK'D: DANUSA 2022/03/10										PRODUCT CUSTOMER DRAWING																																																																																																																																																																																																							
				APPR: MRAMAKRISHNA 2022/03/10																																																																																																																																																																																																																	
				INITIAL REVISION:										DOCUMENT NUMBER																																																																																																																																																																																																							
				DRWN: KSEE 2003/12/22																																																																																																																																																																																																																	
				APPR: MLONG 2009/12/17										SD-87759-208																																																																																																																																																																																																							
				ANGULAR TOL ± 3.0°																																																																																																																																																																																																																	
DRAFT WHERE APPLICABLE MUST REMAIN WITHIN DIMENSIONS				THIRD ANGLE PROJECTION		DRAWING		SERIES		MATERIAL NUMBER		CUSTOMER		SHEET NUMBER																																																																																																																																																																																																							
						A3-SIZE		87759		SEE TABLE		GENERAL MARKET		4 OF 4																																																																																																																																																																																																							
<table border="1"> <tr> <td>DOCUMENT STATUS</td> <td>P1</td> <td>RELEASE DATE</td> <td>2022/03/10</td> <td>13:29:35</td> <td colspan="11"></td> </tr> </table>																DOCUMENT STATUS	P1	RELEASE DATE	2022/03/10	13:29:35																																																																																																																																																																																																	
DOCUMENT STATUS	P1	RELEASE DATE	2022/03/10	13:29:35																																																																																																																																																																																																																	
A																																																																																																																																																																																																																					