

ON Semiconductor

Is Now

The logo for onsemi, featuring the word "onsemi" in a dark teal, lowercase, sans-serif font. The letter "i" is stylized with a white dot and a teal vertical bar. A small orange triangle is positioned above the top right of the "i". A trademark symbol (TM) is located to the right of the logo.

To learn more about onsemi™, please visit our website at
www.onsemi.com

onsemi and **onsemi** and other names, marks, and brands are registered and/or common law trademarks of Semiconductor Components Industries, LLC dba "**onsemi**" or its affiliates and/or subsidiaries in the United States and/or other countries. **onsemi** owns the rights to a number of patents, trademarks, copyrights, trade secrets, and other intellectual property. A listing of **onsemi** product/patent coverage may be accessed at www.onsemi.com/site/pdf/Patent-Marking.pdf. **onsemi** reserves the right to make changes at any time to any products or information herein, without notice. The information herein is provided "as-is" and **onsemi** makes no warranty, representation or guarantee regarding the accuracy of the information, product features, availability, functionality, or suitability of its products for any particular purpose, nor does **onsemi** assume any liability arising out of the application or use of any product or circuit, and specifically disclaims any and all liability, including without limitation special, consequential or incidental damages. Buyer is responsible for its products and applications using **onsemi** products, including compliance with all laws, regulations and safety requirements or standards, regardless of any support or applications information provided by **onsemi**. "Typical" parameters which may be provided in **onsemi** data sheets and/or specifications can and do vary in different applications and actual performance may vary over time. All operating parameters, including "Typicals" must be validated for each customer application by customer's technical experts. **onsemi** does not convey any license under any of its intellectual property rights nor the rights of others. **onsemi** products are not designed, intended, or authorized for use as a critical component in life support systems or any FDA Class 3 medical devices or medical devices with a same or similar classification in a foreign jurisdiction or any devices intended for implantation in the human body. Should Buyer purchase or use **onsemi** products for any such unintended or unauthorized application, Buyer shall indemnify and hold **onsemi** and its officers, employees, subsidiaries, affiliates, and distributors harmless against all claims, costs, damages, and expenses, and reasonable attorney fees arising out of, directly or indirectly, any claim of personal injury or death associated with such unintended or unauthorized use, even if such claim alleges that **onsemi** was negligent regarding the design or manufacture of the part. **onsemi** is an Equal Opportunity/Affirmative Action Employer. This literature is subject to all applicable copyright laws and is not for resale in any manner. Other names and brands may be claimed as the property of others.

User Guide for
FEBFAN6756MR_T03U065A
Evaluation Board

Green-Mode mWSaver™ PWM Controller
for Flyback Converter FAN6756MRMY
65 W (19 V/3.42 A) NB Adapter

Featured Fairchild Product: FAN6756

***Direct questions or comments
about this evaluation board to:
“Worldwide Direct Support”***

Fairchild Semiconductor.com

Table of Contents

1. Introduction.....	3
1.1. Description	3
1.2. Features	4
2. Functional Test Report.....	5
2.1. Input Current	6
2.2. Input Power At No-Load Condition.....	6
2.3. Turn-On Time	6
2.4. DC Output Rising Time	7
2.5. Line and Load Regulation	7
2.6. Efficiency	7
2.7. Output Ripple & Noise.....	8
2.8. Step Response	10
2.9. Over-Current Protection (OCP)	11
2.10. Hold-up Time	11
2.11. Short-Circuit Protection (SCP).....	12
2.12. Brown-in / out Test.....	12
2.13. V _{DD} Voltage Level.....	12
2.14. Voltage Stress of MOSFET and Rectifiers.....	13
2.15. Limit Power Source (LPS)	15
2.16. HV Discharge Test	15
2.17. Maximum Output Load for Exiting Standby Mode	16
2.18. Conducted Emission (EMI).....	16
2.19. Lighting Surges	19
2.20. Electrostatic Discharge (ESD).....	19
3. Photographs.....	20
4. Printed Circuit Board	21
5. Schematic.....	22
6. Bill of Materials	23
7. Transformer / Output Inductor / Heat Sink.....	25
8. Revision History	31

This user guide supports the evaluation kit for the FAN6765MR. It should be used in conjunction with the FAN6756MR datasheets as well as Fairchild’s application notes and technical support team. Please visit Fairchild’s website at www.fairchildsemi.com.

1. Introduction

This document describes a 65W power supply using FAN6756MR. The FAN6756MR mWSaver™ controller targets power adapters that demand extremely low standby power consumption. With innovative mWSaver™ technology, FAN6756MR dramatically reduces standby and no-load power consumption. The AX-CAP® technology minimizes losses in the EMI filter stage by eliminating the X-cap discharge resistors while meeting IEC61010-1 safety requirements. Standby Mode switches feedback impedance during Burst Mode operation, which forces the system to operate in a “deep” Burst Mode with minimum switching losses. Proprietary asynchronous jitter decreases EMI emission and built-in synchronized slope compensation allows more stable Peak-Current-Mode control over a wide range of input voltage and load conditions.

1.1. Description

The FAN6756 is a next-generation Green Mode PWM controller with innovative mWSaver™ technology, which dramatically reduces standby and no-load power consumption, conforming to worldwide Standby Mode efficiency guidelines.

An innovative AX-CAP® method minimizes losses in the EMI filter stage by eliminating the X-cap discharge resistors while meeting IEC61010-1 safety requirements. Standby Mode clamps feedback voltage and modulates feedback impedance with an impedance modulator during Burst Mode operation, which forces the system to operate in a “deep” Burst Mode with minimum switching losses.

Protections ensure safe operation of power system in various abnormal conditions. Proprietary asynchronous jitter decreases EMI emission and built-in synchronized slope compensation allows more stable Peak-Current-Mode control over wide range of input voltage and load conditions. The proprietary internal line compensation ensures constant output power limit over entire universal line voltage range.

Requiring a minimum number of external components, FAN6756 provides a basic platform that is well suited for cost-effective flyback converter designs that require extremely low standby power consumption.

Table 1. Specifications

Specification	Min.	Max.	Unit
Input Voltage	90	264	V _{AC}
Frequency	47	63	Hz
Output Voltage		19	V
Output Current		3.42	A
Total Output Power		65	W

2. Functional Test Report

Table 2. Summary of Features and Performance

Test Model	FEBFAN6756MR_T03U065A
Test Date	2011-07-19
Test Temperature	Ambient
Test Equipment	<ol style="list-style-type: none"> 1. AC Source: 6220 AC POWER SOURCE 2. Electronic Load: Chroma 63030 3. Power Meter: WT210 4. Oscilloscope: Tektronix TDS3014B 5. Differential Probe: LDP-6002
Test Items	<ol style="list-style-type: none"> 1. Input current 2. Input power at no-load condition 3. Turn on time 4. DC output rise time 5. Line and load regulation 6. Efficiency 7. Output ripple & noise 8. Step response 9. Over-Current Protection (OCP) 10. Hold-up time 11. Short-Circuit Protection (SCP) 12. Brownin/out test 13. V_{DD} voltage level 14. Voltage stress of MOSFET and rectifiers 15. Limit Power Source (LPS) 16. HV discharge test 17. Maximum output load of exiting Standby Mode 18. Conducted emission 19. Lighting surges 20. Electrostatic Discharge (ESD)

2.1. Input Current

2.1.1 Test Conditions

The input current at max-load is recorded after meter readings are stable. The specification for input current at maximum load condition is under 2 A.

2.1.2 Test Results

Input Voltage	Input Current	Specification
90 V / 60 Hz	1.595 A	<2 A
264 V / 50 Hz	0.689 A	

2.2. Input Power At No-Load Condition

2.2.1 Test Conditions

The no-load input power and output voltage measurements are recorded after the input power is stable. The specification for input power at no-load condition is under 30 mW.

2.2.2 Test Results

Input Voltage	Input Wattage	Burst Frequency	Output Voltage	Specification
230 V / 50 Hz	24 mW	0.95 Hz	18.8~19.2 V	<30 mW
264 V / 50 Hz	27 mW	0.88 Hz	18.8~19.2 V	

2.2.3 Measured Waveforms

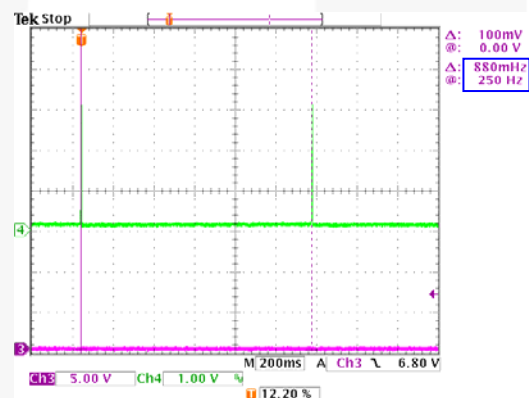

Figure 2. Burst Frequency, 264 V / 50 HZ at No Load, (CH3: Gate, CH4: FB)

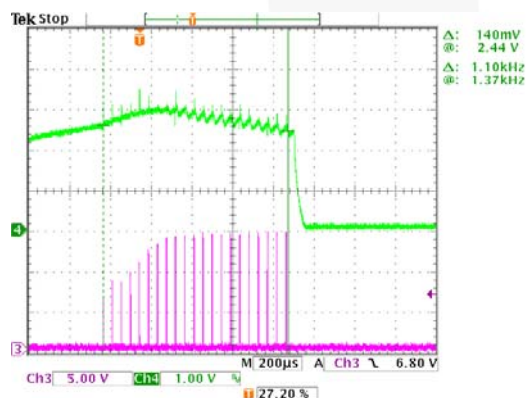

Figure 3. Switching Frequency, 264 V / 50 HZ at No Load, (CH3: Gate, CH4: FB)

2.3. Turn-On Time

2.3.1 Test Conditions

The electronic load is set to the maximum continuous output current. The specification for turn-on time at the maximum load condition is under three seconds.

2.3.2 Test Results

Input Voltage	Turn-On Time	Specification
90 V / 60 Hz	1.48 s	<3 s
264 V / 50 Hz	0.44 s	

2.4. DC Output Rising Time

2.4.1 Test Conditions

The electronic load is set to the maximum continuous output current. The specification for DC output rising time from 10% to 90% of the maximum load condition is within 20 ms.

2.4.2 Test Results

Input Voltage	Maximum Load	Specification
90 V/60 Hz	9.76 ms	<20 ms
264 V/50 Hz	3.41 ms	

2.5. Line and Load Regulation

2.5.1 Test Conditions

Output voltage measurements are recorded after output voltage is stable. The specification for line and load regulation at no load and full load condition is under 5%.

2.5.2 Test Results

Input Voltage	Output Voltage at 0% Load	Output Voltage at 100% Load	Load Regulation	Specification
90 V / 60 Hz	19.07 V~18.83 V	18.908 V	0.85%	<5%
115 V / 60 Hz	19.06 V~18.81 V	18.776 V	1.49%	
230 V / 50 Hz	19.03 V~18.82 V	18.868 V	0.85%	
264 V / 50 Hz	19.03 V~18.81 V	18.866 V	0.86%	
Line Regulation	1.37%	0.69%		

2.6. Efficiency

2.6.1 Test Conditions

Efficiency measurements are recorded after meter readings are stable. The specification for the average efficiency at 25%, 50%, 75%, and 100% of full load condition is above 86%, while the specification for efficiency at light-load condition is above 60%.

2.6.2 Test Results

20AWG Output Cable without Remote Sense

Input Voltage	25% (0.855 A)	50% (1.71 A)	75% (2.565 A)	100% (3.42 A)	Average	Specification
90 V / 60 Hz	87.65%	87.29%	86.04%	84.38%	86.34%	Avg.> 86%
115 V / 60 Hz	88.48%	88.58%	87.45%	86.22%	87.68%	
230 V / 50 Hz	88.00%	87.89%	87.92%	87.47%	87.82%	
264 V / 50 Hz	87.72%	88.24%	87.88%	87.46%	87.83%	

Input Voltage	10.4 mA Loading (0.199 W)	12 mA Loading (0.232 W)	25.5 mA Loading (0.495 W)	30 mA Loading (0.582 W)	Specification
90 V/60 Hz	72.17%	74.51%	80.50%	81.89%	>60%
115 V/60 Hz	71.58%	74.27%	80.69%	82.01%	
230 V/50 Hz	67.31%	68.34%	77.03%	78.89%	
264 V/50 Hz	65.34%	67.71%	75.38%	77.32%	

2.7. Output Ripple & Noise

2.7.1 Test Conditions

Output ripple and noise are measured in maximum and minimum load condition using a 20 MHz-bandwidth oscilloscope. The output is shunted with a 10 μ F capacitor and a high-frequency 0.1 μ F capacitor. The minimum load is defined by the minimum normal operation loading for FAN6756MR. If the output load is under the minimum load, FAN6756 may enter Standby Mode operation.

2.7.2 Test Results

Input Voltage	Max. Load (3.42 A)	Min. Load (6 mA)	No Load
90 V / 60 Hz	88 mV	34 mV	348 mV
115 V / 60 Hz	64 mV	41 mV	332 mV
230 V / 50 Hz	47 mV	80 mV	384 mV
264 V / 50 Hz	46 mV	78 mV	404 mV

2.7.3 Measured Waveforms

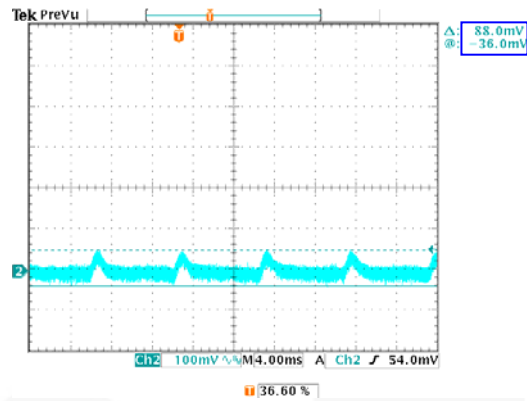

Figure 4. Maximum Load, 90 V / 60 Hz, (CH2: V_{OUT})

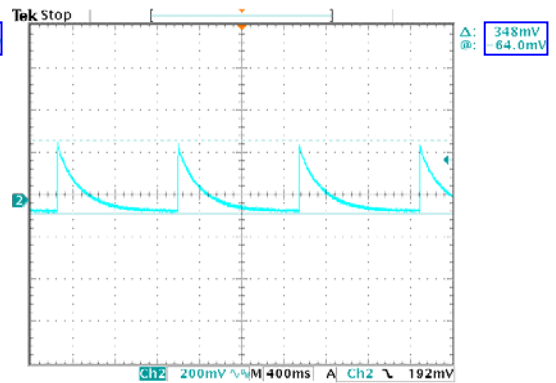

Figure 5. No-Load, 90 V / 60 Hz, (CH2: V_{OUT})

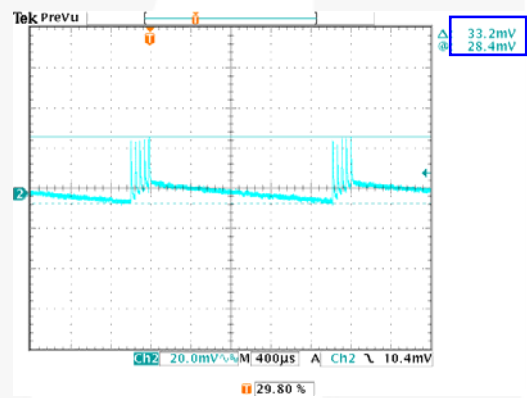

Figure 6. Minimum Load, 90 V / 60 Hz, (CH2: V_{OUT})

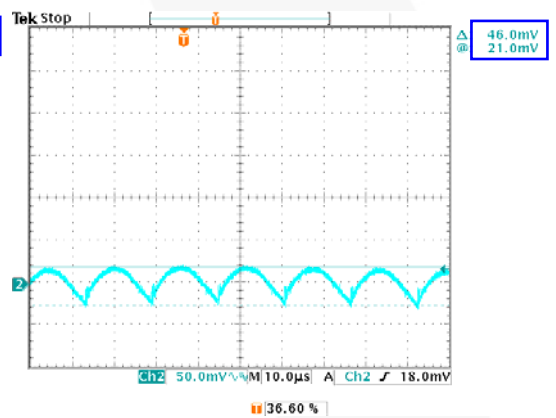

Figure 7. Maximum Load, 264 V / 50 Hz, (CH2: V_{OUT})

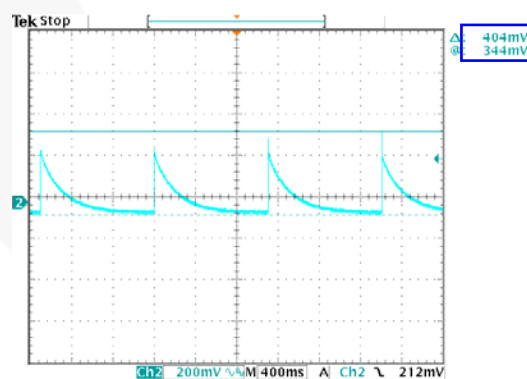

Figure 8. No-Load, 264 V / 50 Hz, (CH2: V_{OUT})

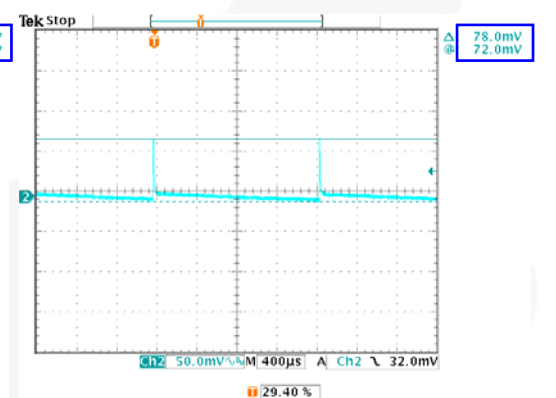

Figure 9. Minimum Load, 264 V / 50 Hz, (CH2: V_{OUT})

2.8. Step Response

2.8.1 Test Conditions

The output load changes from 20% to 80% of full load at 5ms duty cycle with a slew rate of 2.5 A/ μ s. The specification for overshoot and under shoot is under 250 mV.

2.8.2 Test Results

Input Voltage	Overshoot	Undershoot	Specification
115 V / 60 Hz	136 mV	138 mV	<250 mV
230 V / 50 Hz	136 mV	146 mV	

2.8.3 Measured Waveforms

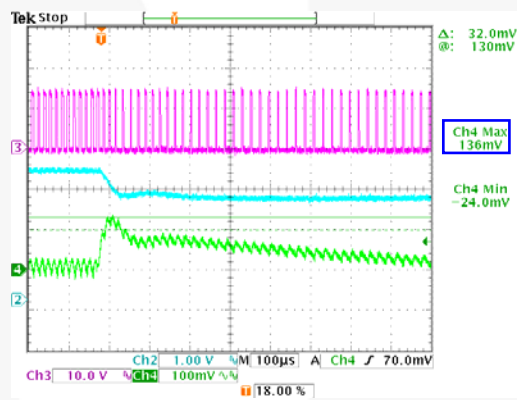

Figure 10. Overshoot, 115 V / 60 Hz, (CH2: V_{OUT}, CH3: Gate, CH4: V_{OUT})

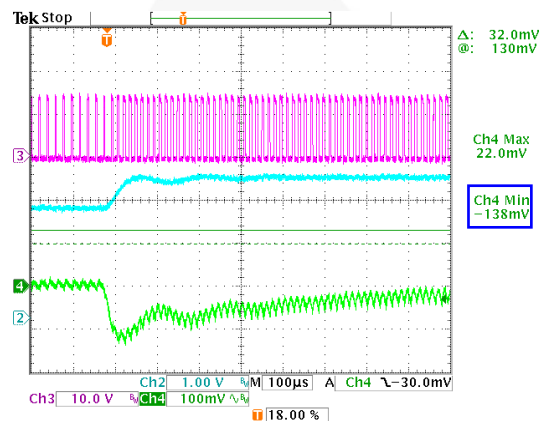

Figure 11. Undershoot, 115 V / 60 Hz, (CH2: V_{OUT}, CH3: Gate, CH4: V_{OUT})

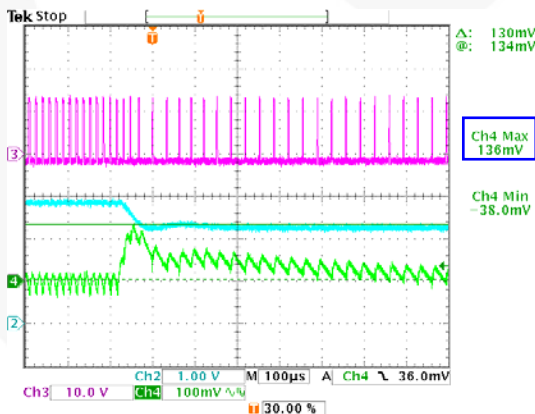

Figure 12. Overshoot, 230 V / 50 Hz, (CH2: V_{OUT}, CH3: Gate, CH4: V_{OUT})

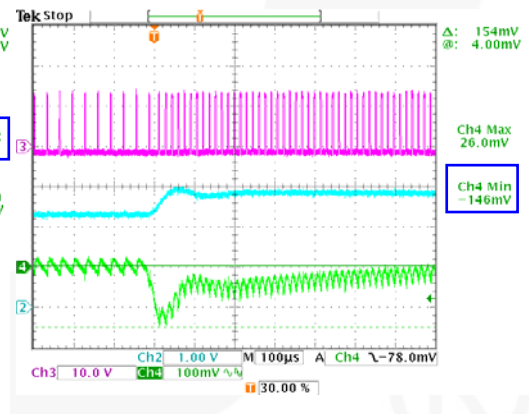

Figure 13. Undershoot, 230 V / 50 Hz, (CH2: V_{OUT}, CH3: Gate, CH4: V_{OUT})

Note:

1. CH2 = DC coupling, CH4 = AC coupling.

2.9. Over-Current Protection (OCP)

2.9.1 Test Conditions

The electronic load is set in Constant Current (CC) Mode and the output load is gradually increased until the Over-Current Protection (OCP) is triggered. The specification for OCP is under 5.5 A.

2.9.2 Test Results

Input Voltage	Output Current	Specification
90 V / 60 Hz	4.400 A	<5.5 A
115 V / 60 Hz	4.740 A	
230 V / 50 Hz	4.875 A	
264 V / 50 Hz	4.830 A	

2.10. Hold-up Time

2.10.1 Test Conditions

The electronic load is set to be the maximum continuous output load. The AC waveform should be turned-off at zero degree. The hold-up time is measured time from AC-off to the falling edge of output voltage.

2.10.2 Test Results

Input Voltage	Hold-up Time
90 V / 60 Hz	6.0 ms
115 V / 60 Hz	13.2 ms
230 V / 50 Hz	81.6 ms
264 V / 50 Hz	111.0 ms

2.10.3 Measured Waveforms

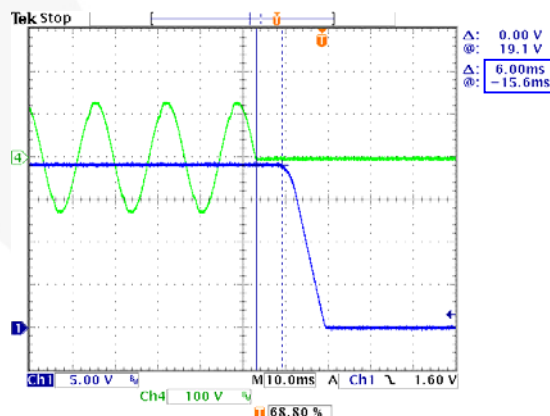

Figure 14. 90 V / 60 Hz at Maximum Load, (CH1: V_{OUT}, CH4: V_{AC})

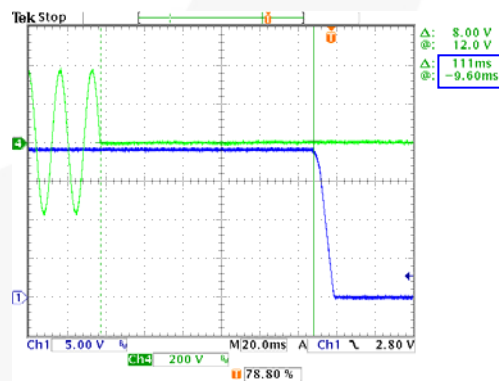

Figure 15. 264 V / 50 Hz at Maximum Load, (CH1: V_{OUT}, CH4: V_{AC})

2.11. Short-Circuit Protection (SCP)

2.11.1 Test Conditions

The output is pre-short and the average input power is measured after stabilization of the meter. The specification for average input power in short-circuit protection condition is under 5 W.

2.11.2 Test Results

Input Voltage	Average Input Power at Maximum Loading	Specification
90 V / 60 Hz	0.95 W	<5 W
264 V / 50 Hz	1.87 W	

2.12. Brown-in / out Test

2.12.1 Test Conditions

The electronic load is set to the maximum continuous output current. The HV pin resistor is set to 150 k Ω and 200 k Ω , respectively. The brownout level is measured by decreasing the input voltage from 85 V gradually; while the brown-in level is measured by increasing the input voltage gradually after brownout. The specification for the difference of brown-in and brown-out level at maximum output load condition is under 10 V.

2.12.2 Test Results

R _{HV}	Brown-in	Brownout	$\Delta V = \text{Brown-in} - \text{Brownout}$
150 k Ω	66 V	63 V	3 V
200 k Ω	78 V	74 V	4 V

2.13. V_{DD} Voltage Level

2.13.1 Test Conditions

The V_{DD} voltage levels are measured while the output load is increased from no load, minimum load, and maximum load to near over-power protection (OPP). The maximum value of V_{DD} at output-short condition is recorded.

2.13.2 Test Results

	No Load	Min. Load	Max. Load	Near OPP	Output Short
90 V / 60 Hz	7.1~16.6 V	16.4 V	22.2 V	23.4 V	22.5 V
264 V / 50 Hz	7.1~16.6 V	16.3 V	21.2 V	22.3 V	21.2 V

2.14. Voltage Stress of MOSFET and Rectifiers

2.14.1 Test Conditions

The peak voltage of the MOSFET (V_{DS}) and secondary rectifier (V_{KA}) is measured at 264 V input voltage and maximum output load. Measurements are taken in steady-state, output short, startup, and turn-off conditions. The specification for the voltage rating of MOSFET and rectifiers are under 650 V and 150 V, respectively.

2.14.2 Test Results

	Stress on MOSFET (V_{DS})	Rating	Stress on Output Rectifier (V_{KA})	Rating
264 V / 50 Hz, Max. Load (Steady-State)	570 V	650 V	130 V	150 V
264 V / 50 Hz, Max. Load, (Output Short)	596 V		122 V	
264 V / 50 Hz, Max. Load, (Startup)	592 V		124 V	
264 V / 50 Hz, Max. Load, (Turn-Off)	596 V		128 V	

2.14.3 Measured Waveforms

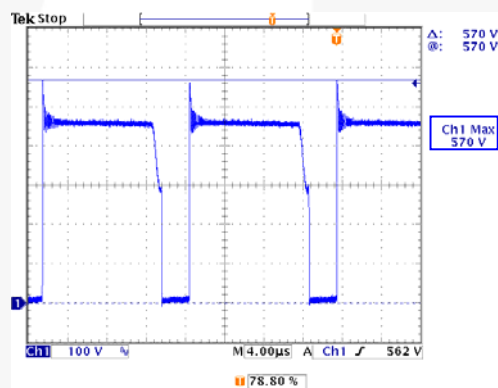

Figure 16. V_{DS} at Max. Load, (Steady-State Operation), 264 V / 50 Hz, (CH1: V_{DS})

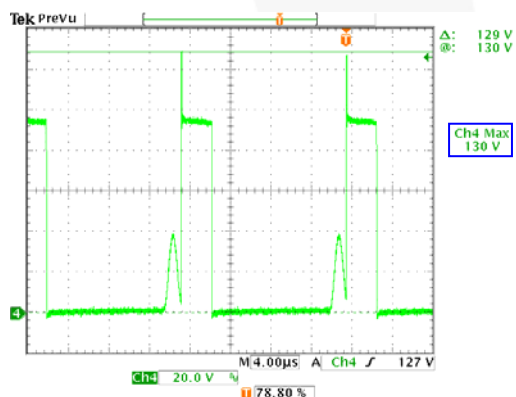

Figure 17. V_D at Max. Load, (Steady-State Operation), 264 V / 50 Hz, (CH4: V_{KA})

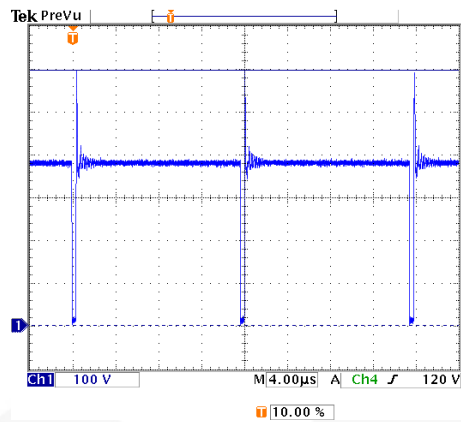

Figure 18. V_{DS} at Max. Load, (Output Short), 264 V / 50 Hz, (CH1: V_{DS})

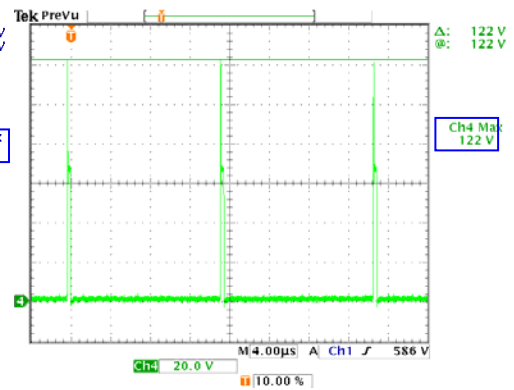

Figure 19. V_D at Max. Load, (Output Short), 264 V / 50 Hz, (CH4: V_{KA})

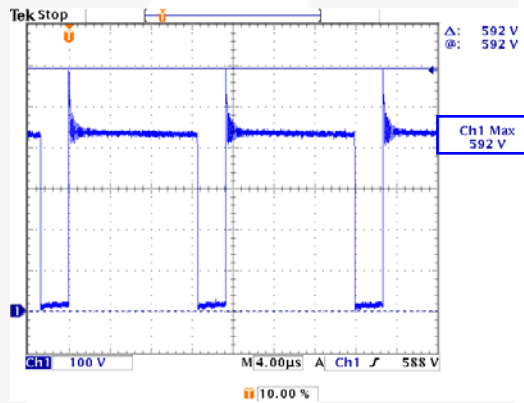

Figure 20. V_{DS} at Max. Load, (Startup), 264 V / 50 Hz, (CH1: V_{DS})

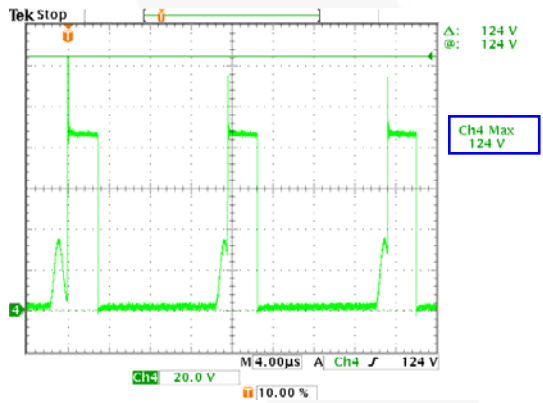

Figure 21. V_D at Max. Load, (Startup), 264 V / 50 Hz, (CH4: V_{KA})

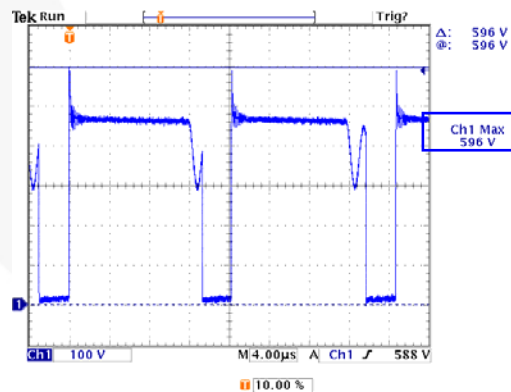

Figure 22. V_{DS} at Max. Load, (Turn-Off), 264 V / 50 Hz, (CH1: V_{DS})

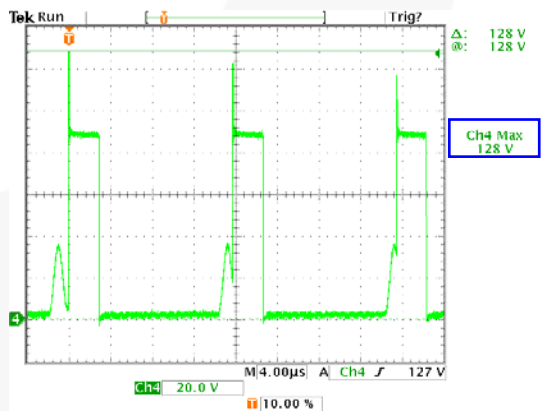

Figure 23. V_D at Max. Load, (Turn-Off), 264 V / 50 Hz, (CH4: V_{KA})

2.15. Limit Power Source (LPS)

2.15.1 Test Conditions

The sense pin is shorted to ground at first then the system is turned-on to check if the Limit Power Source (LPS) function is triggered. If LPS is triggered, the system enters Auto-Recovery Mode.

2.15.2 Test Results

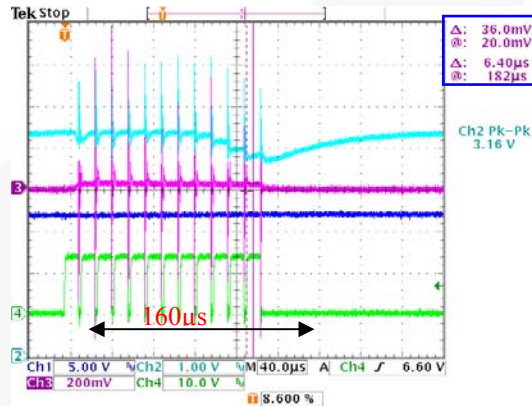

Figure 24. 90 V / 60 Hz at (CH1: V_{DD}, CH2: FB, CH3: Sense, CH4: Gate)

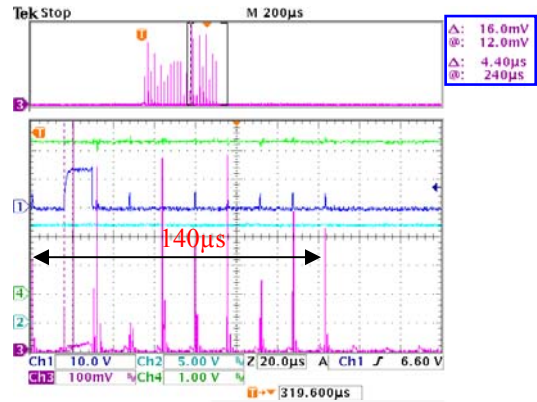

Figure 25. 264 V / 50 Hz at (CH1: V_{DD}, CH2: FB, CH3: Sense, CH4: Gate)

2.16. HV Discharge Test

2.16.1 Test Conditions

Unplug the power line and measure the discharge time of the X-cap at no-load condition. The discharge time must be less than 1 second when X-cap voltage reaches 37% of its peak value.

2.16.2 Test Results

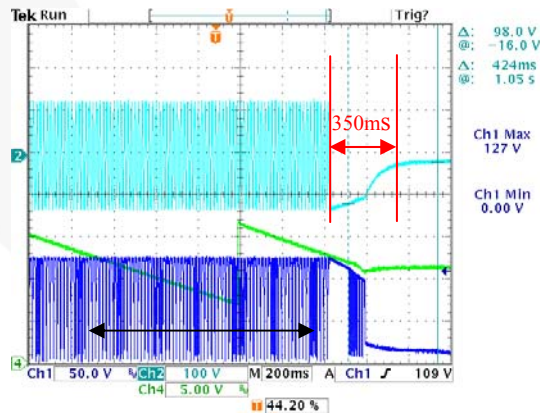

Figure 26. 90 V / 60 Hz at No-Load, (CH1: HV, CH2: V_{AC}, CH4: V_{DD})

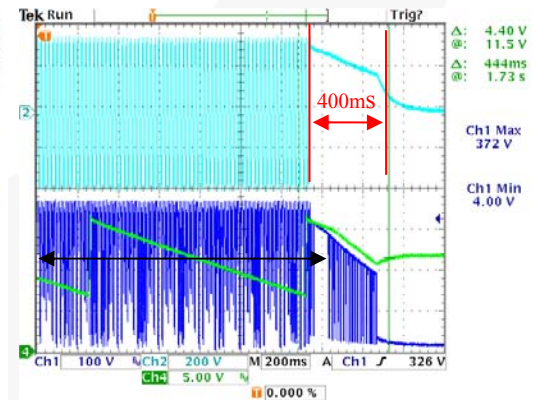

Figure 27. 264 V / 50 Hz at No-Load, (CH1: HV, CH2: V_{AC}, CH4: V_{DD})

2.17. Maximum Output Load for Exiting Standby Mode

2.17.1 Test Conditions

Increase output load gradually until exiting Standby Mode. The specification for the maximum output load of exiting Standby Mode is under 10 mA.

2.17.2 Test Results

Input Voltage	Enter Normal Mode Loading	Specification
90 V / 60 Hz	4.5 mA (87.3 mW)	<10 mA
115 V / 60 Hz	4.5 mA (87.3 mW)	
230 V / 50 Hz	6.0 mA (116.4 mW)	
264 V / 50 Hz	6.0 mA (116.4 mW)	

2.18. Conducted EMI

2.18.1 Test Conditions

Input voltage is set to 115 V and 230 V, respectively. The output ground is not connected to EMI ground (earth ground). The specification for conducted emission of peak reading at maximum load condition is under 6dB of QP line.

2.18.2 Test Results

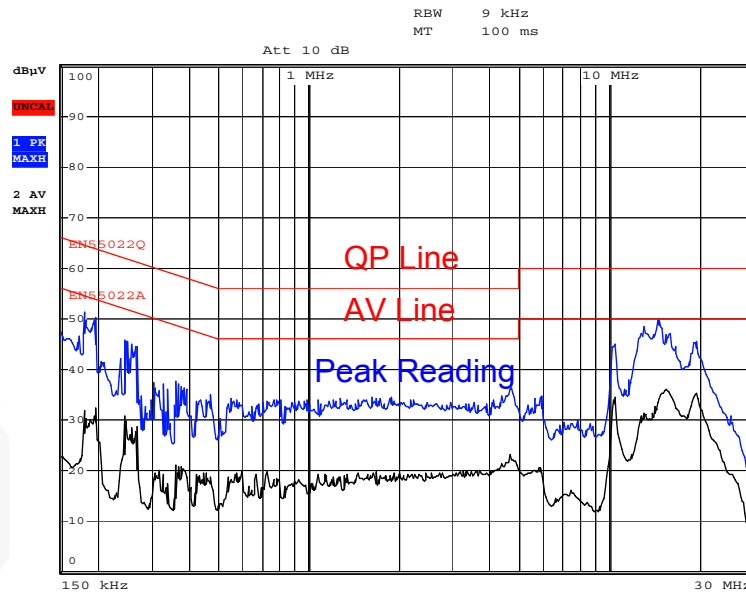

Date: 10.AUG.2011 06:08:01

Figure 28. Conduction-Line at 115 V_{AC}

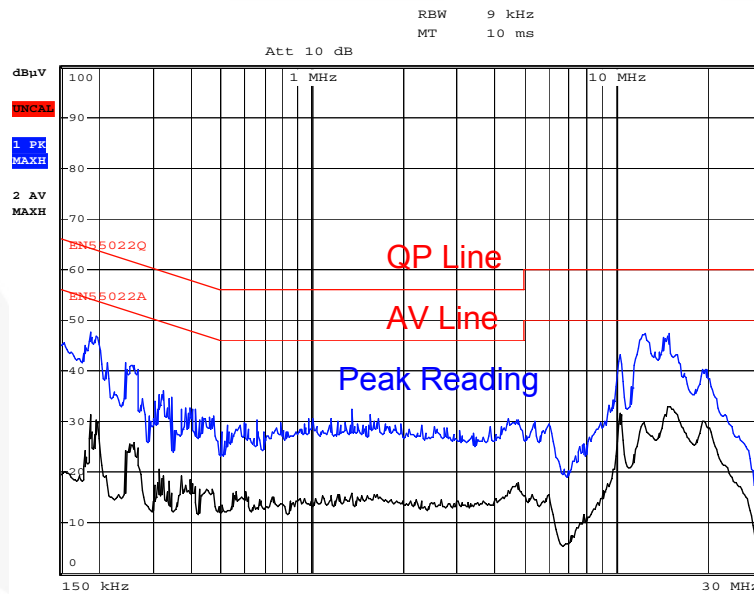

Date: 10.AUG.2011 06:17:43

Figure 29. Conduction-Neutral at 115 V_{AC}

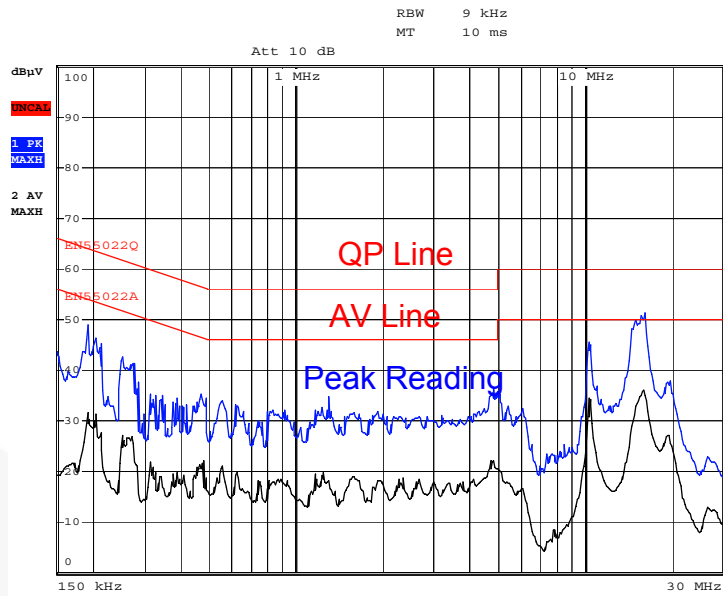

Date: 10.AUG.2011 06:21:28

Figure 30. Conduction-Line at 230 V_{AC}

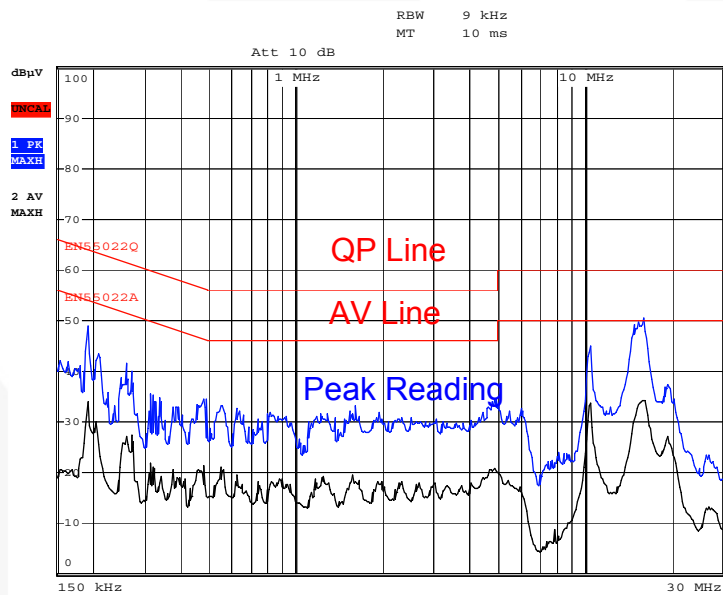

Date: 10.AUG.2011 06:24:02

Figure 31. Conduction-Neutral at 230 V_{AC}

2.19. Lightning Surges

2.19.1 Test Conditions

1. Input voltage: 230 V; Output power: 65 W
2. Combination wave: 1.2/50 μ s open-circuit voltage and 8/20 μ s short-circuit current.
3. The ground connection of the output terminal is connected to earth ground.
4. Mode impedance set: L-to-N: 2 Ω ; L-to-PE, and N-to-PE: 12 Ω .
5. Test voltage: 6 kV at L-to-PE, and N-to-PE; 1 kV at L-to-N.
6. Phase angle: 0°, 90°, 180°, and 270°
7. Polarity: positive and negative.
8. Pulse repetition rate: 20 s.
9. No disruption of functionality in three test samples.

2.19.2 Test Results

Mode	Polarity	Phase	Voltage	Condition
L-N	±	0°	1kV	Pass
	±	90°		Pass
	±	180°		Pass
	±	270°		Pass
L-PE	±	0°	6kV	Pass
	±	90°		Pass
	±	180°		Pass
	±	270°		Pass
N-PE	±	0°	6kV	Pass
	±	90°		Pass
	±	180°		Pass
	±	270°		Pass

2.20. Electrostatic Discharge (ESD)

2.20.1 Test Conditions

1. Input voltage: 230 V; output power: 65 W.
2. Test voltage: 16.5 kV at air discharge and 8.8 kV at contact discharge.
3. Polarity: positive and negative.
4. The ground connection of the output terminal is not connected to AC line ground.
5. No disruption of functionality in three test samples.

2.20.2 Test Results

Air Discharge ±16.5 kV		Contact Discharge ±8.8 kV	
Pass	Pass	Pass	Pass

3. Photographs



Figure 32. Top View

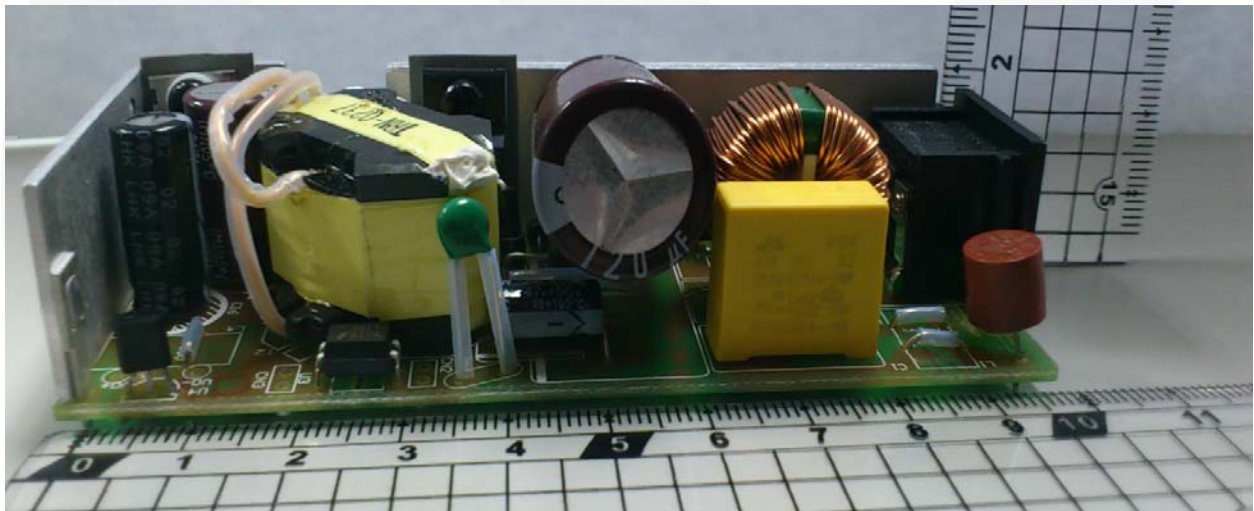

Figure 33. Lateral View

4. Printed Circuit Board

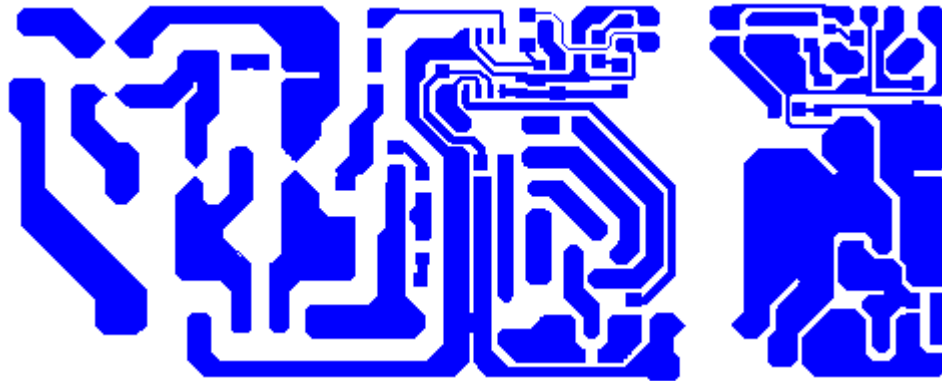

Figure 34. Bottom Layer

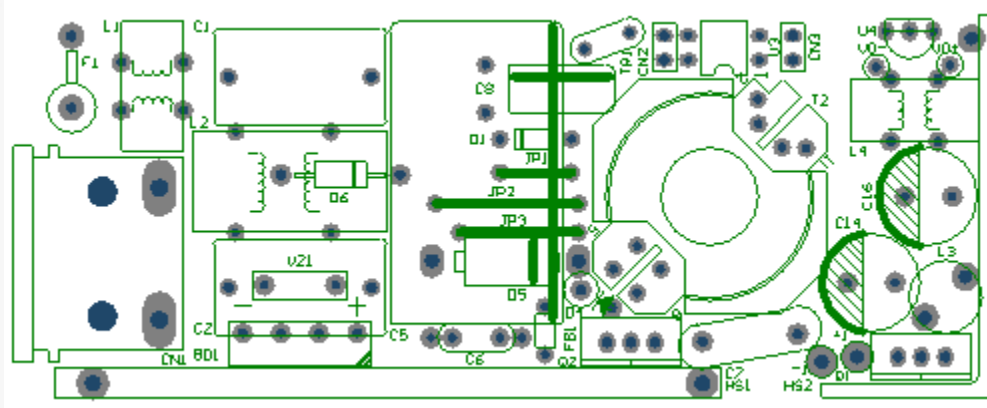

Figure 35. Top Assembly

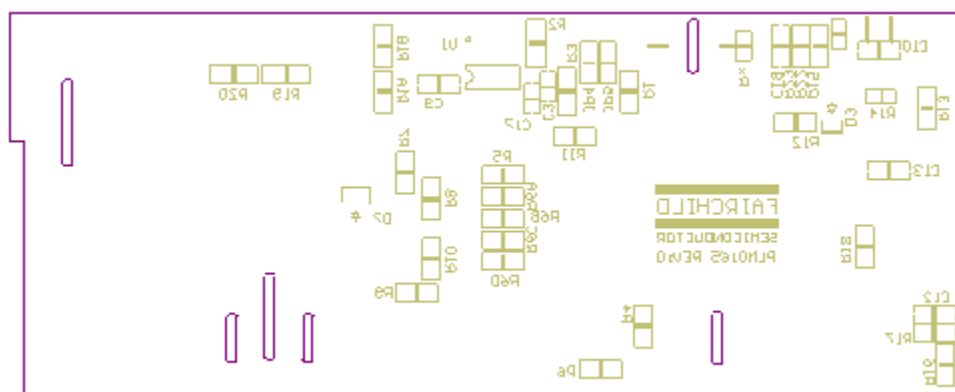

Figure 36. Bottom Assembly

6. Bill of Materials

Reference	Qty.	Part Number	Value	Description	Manufacturer
L1, L4, JP1, JP2, JP3, JP6	8		0.8 ψ (mm)	Jumper Wire	STD
JP4, JP5	2	SMD 0805	0 Ω \pm 5%	Resistor	STD
R15	1	SMD 0805	4.7 k Ω \pm 1%	Resistor	STD
R14	1	SMD 0805	30 k Ω \pm 5%	Resistor	STD
R13	1	SMD 0805	200 k Ω \pm 5%	Resistor	STD
R2, R11	2	SMD 1206	0 Ω \pm 5%	Resistor	STD
R6A, R6B	2	SMD 1206	1.2 Ω \pm 5%	Resistor	STD
R6C, R6D	2	SMD 1206	0.5 Ω \pm 5%	Resistor	STD
R4	1	SMD 1206	20 Ω \pm 5%	Resistor	STD
R16, R17	2	SMD 1206	47 Ω \pm 5%	Resistor	STD
R5	1	SMD 1206	100 Ω \pm 5%	Resistor	STD
R12	1	SMD 1206	1.2 k Ω \pm 5%	Resistor	STD
R3	1	SMD 1206	5.6 k Ω \pm 1%	Resistor	STD
R23	1	SMD 1206	10 k Ω \pm 1%	Resistor	STD
R6	1	SMD 1206	47 k Ω \pm 5%	Resistor	STD
R1A, R1B	2	SMD 1206	100 k Ω \pm 5%	Resistor	STD
TR1	1	TTC05104L	100 k Ω	Thermistor, B25/50=4400 K	TKS
C6	1		10 nF +80/-20% 500 V	Capacitor, Ceramic, Thru-Hole	STD
C17, C3	2	SMD 0805	1 nF \pm 10% 50 V	Capacitor, Ceramic, X7R	STD
C18	1	SMD 1206	100 nF \pm 10% 50 V	Capacitor, Ceramic, X7R	STD
C12	1	SMD 1206	1 nF \pm 10% 100 V	Capacitor, Ceramic, X7R	STD
C13	1	SMD 1206	10 nF \pm 10% 50 V	Capacitor, Ceramic, X7R	STD
C9	1	SMD 1206	470 pF \pm 10% 50 V	Capacitor, Ceramic, X7R	STD
C10	1	SMD 1206	2.2 nF \pm 10% 50 V	Capacitor, Ceramic, X7R	STD
C8	1		47 μ F 50 V	Capacitor, Electrolytic, 105°C, 6.3x11, LHK	JACKCON
C14	1		1000 μ F 25 V	Capacitor, Electrolytic, 105°C, 10x20, KMG	NCCNippon Chemi-con
C5	1		120 μ F 400 V	Capacitor, Electrolytic, 105°C, 18x31.5, KMG	NCCNippon Chemi-con
C16	1		47 0 μ F 25 V	Capacitor, Electrolytic, 105°C, 8x20, LHK	JACKCON
C1	1	HQX334K275I20SANY FY	0.33 μ F \pm 10% 275 V _{AC}	Capacitor, X2 Type, Interference Suppression	uTx
C7	1	CS13-E2GA332MYVSA	222P 250 V \pm 20%	Capacitor, Y2 Type, Ceramic	TDK
L3	1	TRN0083	1.6 μ H	Inductor, R4X12	SEN HUEI
L2	1	TRN0211	9 mH	Common-Mode Choke, RT181007	SEN HUEI
FB1	1	MCH0041		BEAD, C8B, 3.5x3x0.8+T	Bullwill

Reference	Qty.	Part Number	Value	Description	Manufacturer
D4, C7	2	MCH0040		BEAD, C8B, 3.5x3.2x1.0	Bullwill
T2	1	TRN0237	510 μ H	Transformer, RM-10	SEN HUEI
D4	1	FR107	1 A, 700 V	Diode, Fast Recovery, DO-41	CP
D6	1	1N4007	1 A, 1000 V	Diode, General Purpose, DO-41	Fairchild Semiconductor
D1	1	1N4935	1 A, 200 V	Diode, Fast Recovery, DO-41	Fairchild Semiconductor
D7	1	S1M	1 A, 1000 V	Diode, General Purpose, SMA/DO-214AC	Fairchild Semiconductor
BD1	1	2KBP06M	2 A, 600 V,	Bridge Rectifier, KBPM	Fairchild Semiconductor
Q1	1	MBR20150CT	20 A, 150 V	Dual Schottky Rectifier, TO-220	Fairchild Semiconductor
D3	1		20 V, 1/2 W	Diode, Zener, SMD	STD
U4	1	TL431ACZ	\pm 1%, 2.5 V	Shunt Regulator, TO-92R	Fairchild Semiconductor
Q2	1	FQPF7N65C	7 A, 650 V	MOSFET, TO-220F	Fairchild Semiconductor
U3	1	FOD817A	Current Transfer Ratio: 80–160%	Opto-Coupler, DIP-B	Fairchild Semiconductor
U1	1	FAN6756MRMY		PWM Controller, SOP-8	Fairchild Semiconductor
F1	1	MET005	250V 5A	Fuse, Time-Lag, Radial Lead, \varnothing 8.35xH7.7	CONQUER
D5	1	P6KE150A	Breakdown Voltage=143~158 V	TVS, DO-15	Fairchild Semiconductor
CN1	1	R-201SN90(B06)		AC Socket, INLET 2P 90°	STD
HS1	1	MCH0534		Heat Sink, 70(L)x20(H)x3(W)mm	Hardware
HS2	1	MCH0555		Heat Sink, L Type 40x18(L)x 20(H)x1.6(W)mm	Hardware
PWB	1	PLM0165 REV 0		1 Layer, PLM0165 REV 0	PCB

7. Transformer / Output Inductor / Heat Sink SPECIFICATION APPROVAL

1.DIMENSION:

UNIT: mm

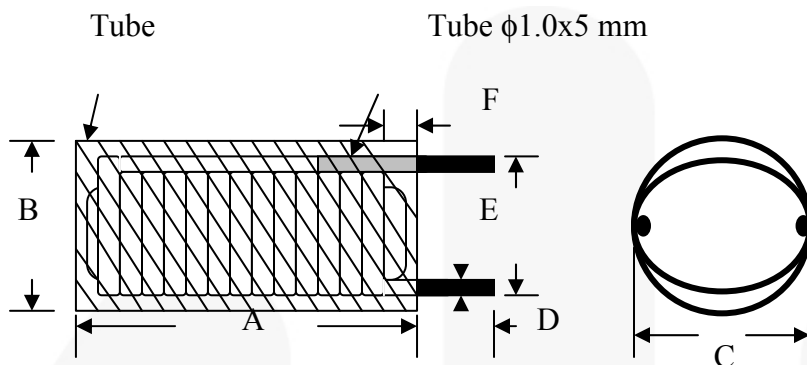

A	14 max.
B	9.0 max.
C	6.0±1
D	3.5±0.3
E	φ0.8±0.1
F	1-2

2.ELECTRICAL SPECIFICATION: at 1 KHz,0.3 V

2.1 INDUCTANCE: 1.6 μH min

2.2 DC RESISTANCE: 11 mOhm max

2.3 TURN & WIRE : φ 0.8x12.5TS(ref)

MATERIALS LIST :

COMPONENT	MAT'L	MANUFACTURE	UL FILE NO.
1.CORE	S6,SGB or equal	Ferrite core R4x12 Jaw Shianq.	
2.WIRE	THFN-216 130°C	Ta Ya Electronic Wire & Cable Co., Ltd.	E197768
	UEWN/U 130°C	Pacific Electronic Wire & Cable Co., Ltd.	E201757
	UEY 130°C	Chuen Yih Wire Co., Ltd.	E174837
3.TUBE	UL TUBE	Shengzhen Changyuan Co., Ltd.	E180908
4.TERMINALS	Tin coated- Copper wire	Will Fore Special Wire Corp.	
5.SOLDER	96.5% Su 3% Ag,0.5% Cu	Xin Yuan Co., Ltd.	

UNIT	m/m	DRAWN	CHECK	TITLE	
TEL	(02)29450588	Ci wun Chen	Guo long Huang	IDENT N O.	TRN-0083
FAX	(02)29447647	SEN HUEI INDUSTRIAL CO.,LTD.		D W G N O.	I0026
No.26-1, Lane 128, Sec. 2, Singnan Rd., Jhonghe City, Taipei County 235, Taiwan (R.O.C.)					

SPECIFICATION APPROVAL

1. DIMENSION:

UNIT: mm

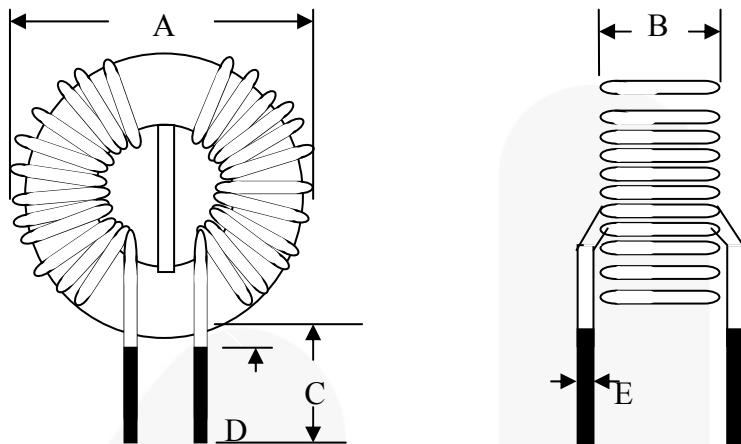

A	25 max.
B	15 max.
C	5 ±1
D	1 max
E	φ0.65±0.1

2. ELECTRICAL SPECIFICATION: at 1kHz, 1V

- 2.1 INDUCTANCE : L1=L2 : 9.0 mH min.
- 2.2 DC RESISTANCE : L1=L2 : 0.78 Ohm max.
- 2.3 TURN & WIRE : L1=L2 : φ 0.65 x 37.5TS

MATERIALS LIST :

COMPONENT	MAT'L	MANUFACTURE	UL FILE NO.
1.CORE	T18x10x7	Core T18x10x7 TOMITA.	
2.WIRE	THFN-216	Ta Ya Electronic Wire & Cable Co., Ltd.	E197768
	UEWN/U	Pacific Wire & Cable Co., Ltd.	E201757
	UEWE	Tai-I Electronic Wire & Cable Co., Ltd.	E85640
	UWY	Jang Shing Wire Co., Ltd.	E174837
3.SOLDER	96.5% Sn,3% Ag,0.5% Cu,	Xin Yuan Co., Ltd.	

UNIT	m/m	DRAWN	CHECK	TITLE	
TEL	(02)29450588	Ci wun Chen	Guo long Huang	IDENT N O.	TRN-0211
FAX	(02)29447647	SEN HUEI INDUSTRIAL CO.,LTD.		D W G N O.	10060
No.26-1, Lane 128, Sec. 2, Singnan Rd., Jhonghe City, Taipei County 235, Taiwan (R.O.C.)					

SPECIFICATION APPROVAL

1. DIMENSION:

Unit: mm

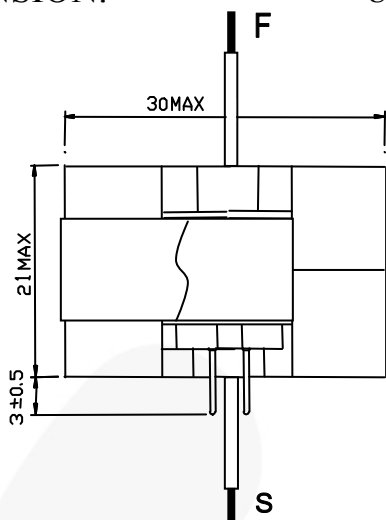

ELEVATION VIEW

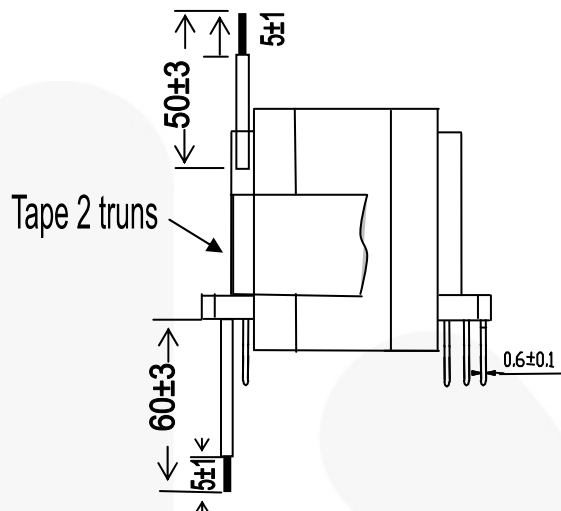

SIDE VIEW

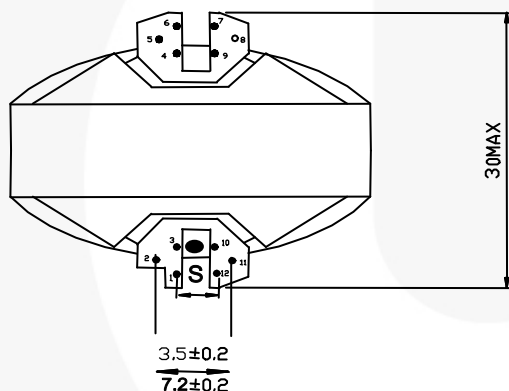

BOTTOM VIEW

TRN-0237

Past label on the top of transformer,
and the wording peak faces pin 1 & pin 12

NOTE:

- 1) Pin 8 No.
- 2) Pin 5 cut off 2/3.
- 3) Add insulation tape *2 turns to fix core and bobbin.

UNIT	m/m	DRAWN	CHECK	TITLE	TRANS
TEL	(02)29450588	Ci wun Chen	Guo long Huang	IDENT N O.	TRN-0237
FAX	(02)29447647	SEN HUEI INDUSTRIAL CO.,LTD.		D W G N O.	I9903 KB773-9192
No.26-1, Lane 128, Sec. 2, Singnan Rd., Jhonghe City, Taipei County 235, Taiwan (R.O.C.)					

SPECIFICATION APPROVAL

2. SCHEMATIC :

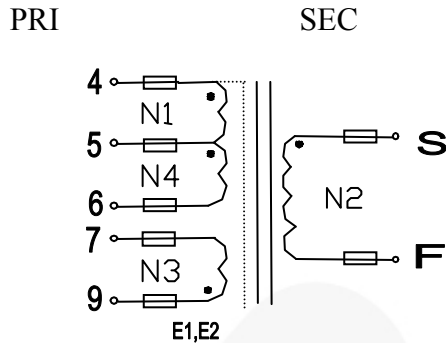

2.1 SCHEMATIC :

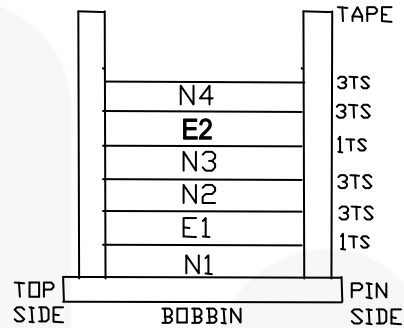

Note: All wires shield winds 0.2 ϕ lead, and Teflon pipe connect to pin4.

2.3 WINDING

STEP	WINDING	MATERIAL	START-FINISH	TURNS	TAPE	REMARK
1	N1	2UEW- ϕ 0.50 \times 1P	4-5	19 ^{TS}	1 ^{TS}	
2	E1	T0.025 \times 7 mm	-4	1.2 ^{TS}	3 ^{TS}	Adhesive tape of copper foil
3	N2	TEX-E - ϕ 0.90 \times 1P	S-F	8 ^{TS}	3 ^{TS}	
4	N3	2UEW- ϕ 0.40 \times 1P	9-7	7 ^{TS}	1 ^{TS}	Middle densely circles
5	E2	T0.025 \times 7 mm	-4	1.2 ^{TS}	3 ^{TS}	Adhesive tape of copper foil
6	N4	2UEW- ϕ 0.50 \times 1P	5-6	19 ^{TS}	3 ^{TS}	

UNIT	m/m	DRAWN	CHECK	TITLE	TRANS
TEL	(02)29450588	Ci wun Chen	Guo long Huang	IDENT N O.	TRN-0237
FAX	(02)29447647	SEN HUEI INDUSTRIAL CO.,LTD.		D W G N O.	19903 KB773-9192
No.26-1, Lane 128, Sec. 2, Singnan Rd., Jhonghe City, Taipei County 235, Taiwan (R.O.C.)					

SPECIFICATION APPROVAL

3. ELECTRICAL SPECIFICATION:

3.1 Inductance test: at 1 kHz ,1 V

$$L_{4-6} = 510 \mu\text{H} \pm 5\%$$

3.2 Leakage inductance: at 1 kHz ,1 V

P(4-6): 20 μH max. (shorted A,B)

3.3 DC Resistance test at 25°C

P(4-6) : 23 mOhm max.

3.4 Hi-pot test:

AC 3.0 kV / 60 Hz / 0.5 mA hi-pot for one minute between pri. to sec.

AC 1.5 kV / 60 Hz / 0.5 mA hi-pot for one minute between pri. to core.

AC 1.5 kV / 60 Hz / 0.5 mA hi-pot for one minute between sec. to core.

3.5 Insulation test:

The insulation resistance is between pri. to sec. and windings to core measured by DC 500 V, must Be over 100 MOhm.

3.6 Terminal strength:

1.0 Kg on terminals for 30 seconds, test the breakdown.

UNIT	m/m	DRAWN	CHECK	TITLE	TRANS
TEL	(02)29450588	Ci wun Chen	Guo long Huang	IDENT NO.	TRN-0237
FAX	(02)29447647	SEN HUEI INDUSTRIAL CO., LTD.		DWG NO.	19903 KB773-9192
No.26-1, Lane 128, Sec. 2, Singnan Rd., Jhonghe City, Taipei County 235, Taiwan (R.O.C.)					

SPECIFICATION APPROVAL

MATERIALS LIST :

COMPONENT	MAT'L	MANUFACTURE	FILE NO.
1.Bobbin	Phenolic 94v-0,T375J,150 °C	RM-10 Chang Chun Plastics Co., Ltd.	E59481(S)
2.Core	FERRITE RM10 R2K (GAP)	Ferrite Core RM-10 Yang Guang Da Co., Ltd.	
3.Wire	UEY 130°C	Hoi Luen Electrical MFR Co., Ltd.	E164409
	TEX-E 130°C	Shenzhen Changyuan Electronic Material Co., Ltd.	E249037
4.Varnish	48562/C 155°C	Hang Cheung Petrochemical Ltd.	E200154
5.Tape	MYLAR TAPE (PZ-YELLOW)	Jingjiang Ya Hua Pressure Sensitive Glue Co., Ltd.	E165111(N)
6.Tube	TEFOLN 200°C 150V	Shenzhen Woer Heat Shrinkable Material Co., Ltd.	E203950
7.Terminals	Tin coated- Copper wire	Will Fore Special Wire Corp.	
8.Shield	Copper foil	Bo Tong Co., Ltd. (copper foil : T0.025mm×7mm +TAPE)	
9.SOLDER	96.5% Su 3% Ag 0.5% Cu	Xin Yuan Co., Ltd.	

UNIT	m/m	DRAWN	CHECK	TITLE	TRANS
TEL	(02)29450588	Ci wun Chen	Guo long Huang	IDENT NO.	TRN-0237
FAX	(02)29447647	SEN HUEI INDUSTRIAL CO., LTD.		DWG NO.	19903 KB773-9192
No.26-1, Lane 128, Sec. 2, Singnan Rd., Jhonghe City, Taipei County 235, Taiwan (R.O.C.)					

8. Revision History

Rev.	Date	Description
1.0.0	February 2012	Initial Release
1.0.1	January 2013	Correct some error in parameter usage and naming in descriptions, added non breaking space before UNOM.

WARNING AND DISCLAIMER

Replace components on the Evaluation Board only with those parts shown on the parts list (or Bill of Materials) in the Users' Guide. Contact an authorized Fairchild representative with any questions.

This board is intended to be used by certified professionals, in a lab environment, following proper safety procedures. Use at your own risk. The Evaluation board (or kit) is for demonstration purposes only and neither the Board nor this User's Guide constitute a sales contract or create any kind of warranty, whether express or implied, as to the applications or products involved. Fairchild warrants that its products meet Fairchild's published specifications, but does not guarantee that its products work in any specific application. Fairchild reserves the right to make changes without notice to any products described herein to improve reliability, function, or design. Either the applicable sales contract signed by Fairchild and Buyer or, if no contract exists, Fairchild's standard Terms and Conditions on the back of Fairchild invoices, govern the terms of sale of the products described herein.

DISCLAIMER

FAIRCHILD SEMICONDUCTOR RESERVES THE RIGHT TO MAKE CHANGES WITHOUT FURTHER NOTICE TO ANY PRODUCTS HEREIN TO IMPROVE RELIABILITY, FUNCTION, OR DESIGN. FAIRCHILD DOES NOT ASSUME ANY LIABILITY ARISING OUT OF THE APPLICATION OR USE OF ANY PRODUCT OR CIRCUIT DESCRIBED HEREIN; NEITHER DOES IT CONVEY ANY LICENSE UNDER ITS PATENT RIGHTS, NOR THE RIGHTS OF OTHERS.

LIFE SUPPORT POLICY

FAIRCHILD'S PRODUCTS ARE NOT AUTHORIZED FOR USE AS CRITICAL COMPONENTS IN LIFE SUPPORT DEVICES OR SYSTEMS WITHOUT THE EXPRESS WRITTEN APPROVAL OF THE PRESIDENT OF FAIRCHILD SEMICONDUCTOR CORPORATION.

As used herein:

- Life support devices or systems are devices or systems which, (a) are intended for surgical implant into the body, or (b) support or sustain life, or (c) whose failure to perform when properly used in accordance with instructions for use provided in the labeling, can be reasonably expected to result in significant injury to the user.
- A critical component is any component of a life support device or system whose failure to perform can be reasonably expected to cause the failure of the life support device or system, or to affect its safety or effectiveness.

ANTI-COUNTERFEITING POLICY

Fairchild Semiconductor Corporation's Anti-Counterfeiting Policy. Fairchild's Anti-Counterfeiting Policy is also stated on our external website, www.fairchildsemi.com, under Sales Support.

Counterfeiting of semiconductor parts is a growing problem in the industry. All manufacturers of semiconductor products are experiencing counterfeiting of their parts. Customers who inadvertently purchase counterfeit parts experience many problems such as loss of brand reputation, substandard performance, failed applications, and increased cost of production and manufacturing delays. Fairchild is taking strong measures to protect ourselves and our customers from the proliferation of counterfeit parts. Fairchild strongly encourages customers to purchase Fairchild parts either directly from Fairchild or from Authorized Fairchild Distributors who are listed by country on our web page cited above. Products customers buy either from Fairchild directly or from Authorized Fairchild Distributors are genuine parts, have full traceability, meet Fairchild's quality standards for handling and storage and provide access to Fairchild's full range of up-to-date technical and product information. Fairchild and our Authorized Distributors will stand behind all warranties and will appropriately address any warranty issues that may arise. Fairchild will not provide any warranty coverage or other assistance for parts bought from Unauthorized Sources. Fairchild is committed to combat this global problem and encourage our customers to do their part in stopping this practice by buying direct or from authorized distributors.

EXPORT COMPLIANCE STATEMENT

These commodities, technology, or software were exported from the United States in accordance with the Export Administration Regulations for the ultimate destination listed on the commercial invoice. Diversion contrary to U.S. law is prohibited.

U.S. origin products and products made with U.S. origin technology are subject to U.S. Re-export laws. In the event of re-export, the user will be responsible to ensure the appropriate U.S. export regulations are followed.