



ELARA-II USER MANUAL

2613021137000

VERSION 1.7

AUGUST 26, 2021

MUST READ

Check for firmware updates

Before using the product make sure you use the most recent firmware version, data sheet and user manual. This is especially important for Wireless Connectivity products that were not purchased directly from Würth Elektronik eiSos. A firmware update on these respective products may be required.

We strongly recommend to include in the customer system design, the possibility for a firmware update of the product.

Revision history

Manual version	FW version	HW version	Notes	Date
1.0	1.0	1.0	<ul style="list-style-type: none"> Initial release of the manual 	February 2020
1.1	1.0	1.0	<ul style="list-style-type: none"> Updated power up description: Figure 4, Table 25 	April 2020
1.2	1.0	1.0	<ul style="list-style-type: none"> Added information about light sensitivity: Chapter 2 Corrected peak reflow temperature: Chapter 12.2 Corrected version of harmonized norm EN 303 413 according to test reports: Chapter 16.5 	May 2020
1.3	1.0	1.0	<ul style="list-style-type: none"> Added assembly information in Chapter 7.1.5 	June 2020
1.4	1.0	1.0	<ul style="list-style-type: none"> Extended description of I²C host connection: Chapter 9.2 Added default UART baud rate to Table 33 	July 2020
1.5	1.0	1.0	<ul style="list-style-type: none"> Added description of SPI host connection and interface: Chapter 8.3 and 9.3 Updated Chapter 6 with recommendation for baud rate selection Updated Chapter 5.4 with information about leap seconds Corrected operating temperature in Table 30 Added Chapter 7.3.1.2 	October 2020

Manual version	FW version	HW version	Notes	Date
1.6	1.0	1.0	<ul style="list-style-type: none"> • Added reference to SPI interface, where missing • Updated ordering information with Extended EV-Kit: Table 1 	March 2021
1.7	1.0	1.0	<ul style="list-style-type: none"> • Updated Desing In Guide and layout recommendation (Chapter 7.1) • Added References chapter (Chapter 15) • Updated Chapter 3.1 	August 2021

Abbreviations

Abbreviation	Name	Description
CEP	Circular Error Probability	Radius of a circle including accuracy measurements data with a given probability
CS	Chip Select	
CTS	Clear To Send	
ECEF	Earth-Centered Earth-Fixed	Coordinate system
EEPROM	Electrically Erasable Programmable Read-Only Memory	
EHE	Estimated Heading Error	
EHPE	Estimated Horizontal Position Error	
EHVE	Estimated Velocity Error	
ESD	Electrostatic Discharge	
FCC	Federal Communications Commission	
FIFO	First In First Out	
GDOP	Geometric Dilution Of Precision	
GLONASS	Global Navigation Satellite System	Russian satellite navigation system
GNSS	Global Navigation Satellite System	
GPIO	General Purpose Input/Output	
GPS	Global Positioning System	American satellite navigation system
HDOP	Horizontal Dilution of Precision	
I ² C	Inter-Integrated Circuit	
IC	Integrated Circuit	
LNA	Low-Noise Amplifier	
LSB	Least Significant Bit	
LPM	Low Power Mode	
MID	Message Identifier	OSP sentence identifier
MISO	Master In Slave Out	
MOSI	Master Out Slave In	
MSL	Mean Sea Level	

Abbreviation	Name	Description
μ C	Microcontroller	
NMEA	National Marine Electronics Association	Standard communication protocol for navigation
OSP	One Socket Protocol	Qualcomm-proprietary communication protocol
PDOP	Position Dilution of Precision	
PPS	Pulse per Second	Pulse signal sent by the GNSS module once a fix with at least 5 SVs is obtained
PRN	Pseudo-Random Noise	SV-specific codes used for ranging and as satellite identifiers
PVT	Position, Velocity, and Time	
QZSS	Quasi-Zenith Satellite System	Satellite-based augmentation system for the Asia-Oceania regions
REACH	Registration, Evaluation, Authorisation and Restriction of Chemicals	
RED	Radio Equipment Directive	Regulatory framework for radio equipment
RF	Radio Frequency	Describes everything relating to the wireless transmission
RNSS	Regional Navigation Satellite System	
RoHS	Restriction of Hazardous Substances	
RTC	Real-Time Clock	
RTS	Ready To Send	
SBAS	Satellite-Based Augmentation System	Satellite systems enhancing GNSS
SCL	Serial Clock Line	
SCLK	Serial Clock	
SDA	Serial Data Line	
SPI	Serial Peripheral Interface	
SV	Space Vehicle	
SWDCLK	Serial Wire Debug Clock	
TCXO	Temperature-Compensated Crystal Oscillator	
TDOP	Time Dilution Of Precision	
TOW	Time Of Week	
TP	Trickle Power	Self-managed low power mode
TTF	Time To First Fix	Time required by the GNSS receiver to obtain first valid position fix

Abbreviation	Name	Description
UART	Universal Asynchronous Receiver Transmitter	
UTC	Coordinated Universal Time	24-h primary time standard
VDOP	Vertical Dilution of Precision	
XTAL	Crystal Oscillator	
WGS84	World Geodetic System 1984	Earth model and reference system

Contents

1	Introduction	9
1.1	Block diagram	10
1.2	Ordering information	10
2	Electrical specifications	11
2.1	Recommended operating conditions	11
2.2	Absolute maximum ratings	11
2.3	Current consumption	12
2.4	Radio characteristics	12
2.5	Pin characteristics	13
3	GNSS performances	14
3.1	Satellite constellations supported	14
3.2	Accuracy	15
3.2.1	Position Accuracy	15
3.2.2	Velocity Accuracy	15
3.2.3	Heading Accuracy	15
3.2.4	Time Accuracy	15
3.3	Time To First Fix	16
3.4	Sensitivity	16
3.5	Dynamic constraints	17
4	Pinout	18
4.1	ON_OFF pin	19
4.2	WAKE_UP pin	20
4.3	/RESET pin	20
4.4	1PPS pin	20
4.5	/RTS and /CTS pins	21
5	Quick start guide	22
5.1	External GNSS antenna	22
5.2	Minimal pin configuration	22
5.3	Power up	22
5.4	Acquisition, first fix, and tracking	24
5.5	Quick start example	26
6	Functional description	27
6.1	Cold, warm, and hot start	28
6.2	Low power modes	29
6.2.1	Host-controlled low power mode	29
6.2.2	Self-managed low power modes	30
6.2.3	Push To Fix	30
6.2.4	Trickle Power mode	32
7	Design in guide	33
7.1	Advice for schematic and layout	33
7.1.1	Footprint	34
7.1.2	Module Footprint on PCB	35
7.1.3	PCB Stackup	36
7.1.4	Module's placement	37

7.1.5	Assembly Information	37
7.2	Dimensioning of the micro strip antenna line	38
7.3	Antenna solutions	39
7.3.1	Antennas provided by Würth Elektronik eiSos	40
7.3.1.1	2600130016 - GNSS Active antenna	40
7.3.1.2	7488920157 - GNSS multilayer chip antenna	41
8	Reference design	42
8.1	Schematic	43
8.2	Layout	46
8.3	Interface Selection for SPI	47
9	Host connection	48
9.1	UART	49
9.2	I ² C multi master	50
9.2.1	General characteristics	50
9.2.2	SDA and SCL logic levels	51
9.2.3	Addressing the GNSS module	51
9.2.4	GNSS communication protocol	51
9.2.5	I ² C timing parameters	51
9.2.6	I ² C communication between Elara-II and a generic Microcontroller	52
9.3	SPI Slave	54
9.3.1	General characteristics	54
9.3.2	Addressing the GNSS module	55
9.3.3	SPI timing parameters	55
9.3.4	GNSS communication protocol	55
9.3.5	SPI communication between Elara-II and a generic Microcontroller	56
10	Elara-II communication protocols	60
10.1	NMEA sentences	60
10.1.1	NMEA sentences overview	63
10.1.2	NMEA output sentences	64
10.1.3	NMEA input sentences	74
10.2	OSP sentences	78
10.2.1	OSP sentences overview	80
10.2.2	OSP output sentences	81
10.2.3	OSP input sentences	88
11	UserSettings	95
11.1	Default Settings	95
12	Manufacturing information	96
12.1	Moisture sensitivity level	96
12.2	Soldering	96
12.2.1	Reflow soldering	96
12.2.2	Cleaning	98
12.2.3	Other notations	98
12.3	ESD handling	99
12.4	Safety recommendations	99
13	Physical dimensions	101
13.1	Dimensions	101

13.2	Weight	101
13.3	Module drawing	102
13.4	Footprint	103
14	Marking	104
14.1	Lot number	104
15	References	105
16	Regulatory compliance information	106
16.1	Important notice EU	106
16.2	Important notice FCC	106
16.3	Conformity assessment of the final product	106
16.4	Exemption clause	106
16.5	EU Declaration of conformity	107
16.6	FCC conformity	108
17	Important notes	109
17.1	General customer responsibility	109
17.2	Customer responsibility related to specific, in particular safety-relevant applications	109
17.3	Best care and attention	109
17.4	Customer support for product specifications	109
17.5	Product improvements	110
17.6	Product life cycle	110
17.7	Property rights	110
17.8	General terms and conditions	110
18	Legal notice	111
18.1	Exclusion of liability	111
18.2	Suitability in customer applications	111
18.3	Trademarks	111
18.4	Usage restriction	111
19	License terms	113
19.1	Limited license	113
19.2	Usage and obligations	113
19.3	Ownership	114
19.4	Disclaimer of warranty	114
19.5	Limitation of liability	114
19.6	Applicable law and jurisdiction	114
19.7	Severability clause	114
19.8	Miscellaneous	115

1 Introduction

Elara-II module is a compact GNSS module for operation in location-based applications, products, and services.

Based on Qualcomm SirfStar V 5e B01 chipset, it supports two major GNSS constellations (GPS and GLONASS) for fast and accurate positioning.

Ultra-compact 4.1mm x 4.1mm design allows the module to fit in small-size applications. UART, I²C and SPI interfaces are available. Connection of external antenna through RF pad is required for module operation. This manual provides design guidelines for hardware integration.

The module can be operated through one of two available communication protocols:

- NMEA (standard) and
- OSP (Qualcomm-proprietary).

Each of these protocols defines a set of commands for module's configuration.

Module's evaluation board [9] (see Table 1) and PC tool [8] allow getting started with the module and testing its functionalities. The evaluation board also represents our reference design. For further information, please refer to the evaluation board manual [3].

The module is RED, RoHS, and REACH certified.

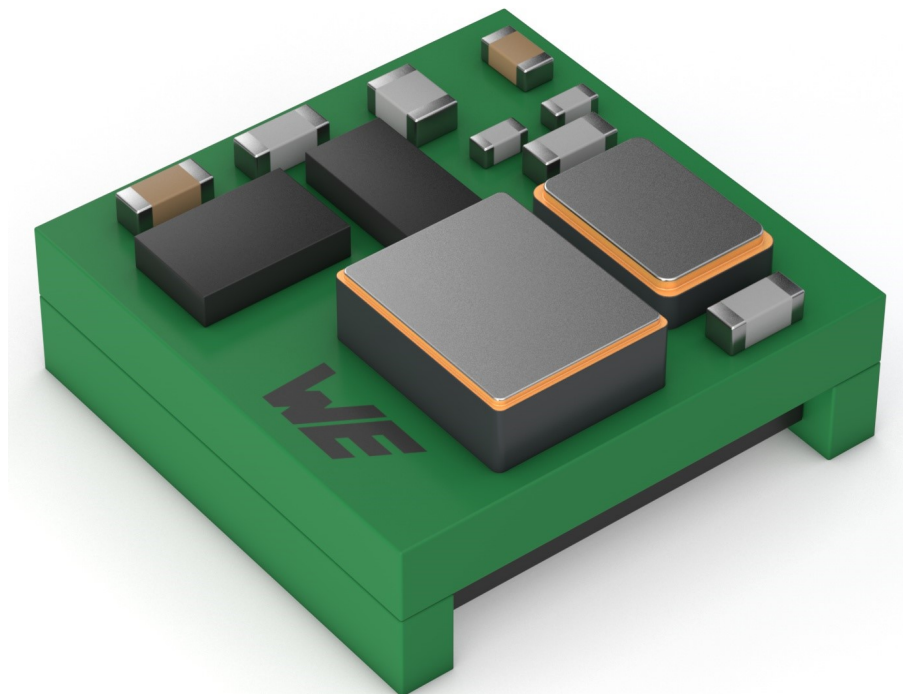

Figure 1: Elara-II module

1.1 Block diagram

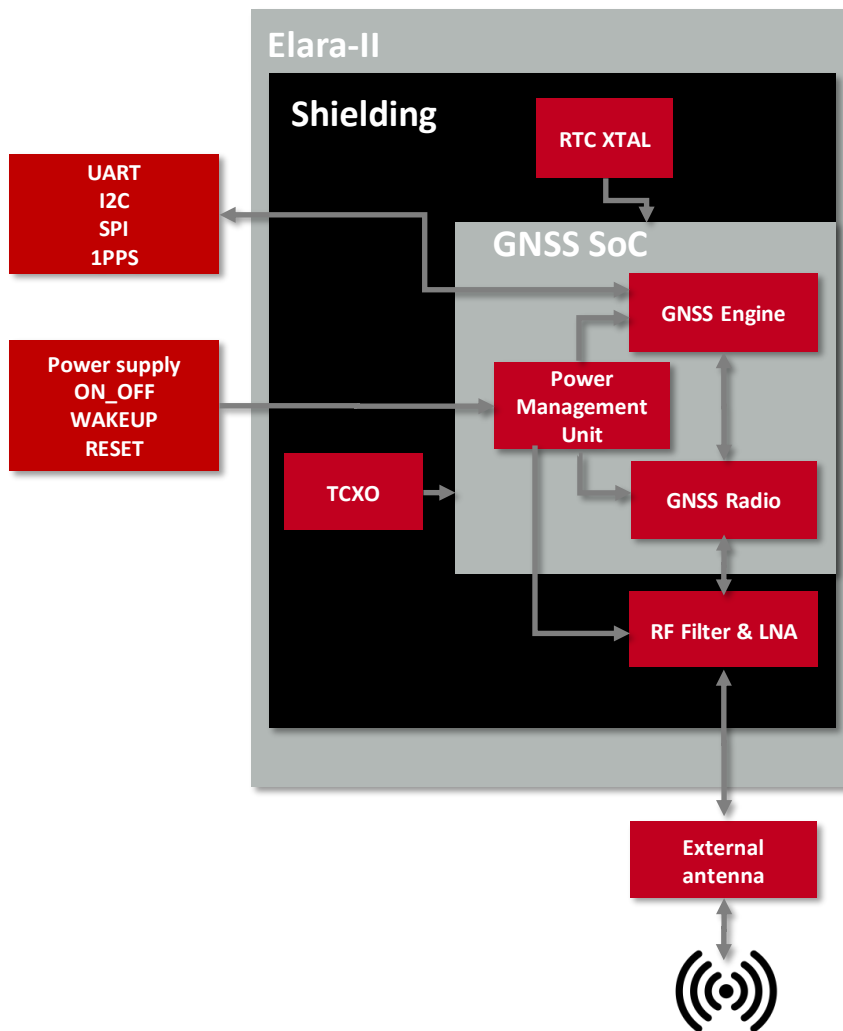

Figure 2: Block diagram

1.2 Ordering information

WE order code	Description
2613021137000	Elara-II GNSS module in T&R packaging
2613029237001	Elara-II Standard EV-Kit
2613029237011	Elara-II Extended EV-Kit (with Thyone-I RF interface)

Table 1: Ordering information

2 Electrical specifications

Unless otherwise stated, all the values given in the manual were measured on the Elara-II evaluation board under the following conditions: T=25°C and VCC=1.8V.



The Elara-II module is sensitive to light. Exposure to light might result in malfunction. For proper functionality the module shall be shielded against light.

2.1 Recommended operating conditions

Description	Min.	Typ.	Max.	Unit
Supply voltage	1.71	1.8	1.89	V
Operating temperature	-40	25	85	°C

Table 2: Recommended operating conditions

1.8 V regulated power supply must be provided to the VCC pin of the module. Inrush current is up to 150 mA for about 20 μ s. Reduction of system noise and voltage ripples is essential to preserve module performances. LC filters, output, bypass and ESR capacitors are recommended in order to maximize stability. Please refer to our reference design.

2.2 Absolute maximum ratings

Description	Min.	Max.	Unit
Supply voltage	-0.3	2.2	V
Supply current		150	mA
GPIO Voltage	-0.3	3.65	V
GPIO Current	-4	4	mA
Power dissipation		350	mW
RF Input power		10	dBm

Table 3: Absolute maximum ratings

2.3 Current consumption

Parameter	State	Mode	Value	Unit
Current consumption	Acquisition	GPS-only	41	mA
		GPS-GLO	52	mA
	Tracking	GPS-only	40	mA
		GPS-GLO	50	mA
	Hibernate		53	μA
	Standby (within TP mode)		170	μA
	Push To Fix	GPS-GLO	1.76	mA
	Trickle Power	GPS-GLO	9.51	mA

Table 4: Current consumption



Current consumption changes according to the received signal strength as well as the GNSS systems. Measurements of the table refer to an average signal strength of -130 dBm.



Push To Fix and Trickle Power mode measurements refer to an average value over a 15 minutes test with 30s rate for Push To Fix and 1s rate for Trickle Power. For details about these low power modes refer to chapter 6

2.4 Radio characteristics

Module performance is based on the quality of the RF link from GNSS satellites to the module. End product design shall foresee:

- external GNSS antenna for signal reception from GNSS satellites
- RF trace delivering the signal from the external antenna to the RF pad of the the GNSS module

A wide range of GNSS antennas exists, varying in dimensions and characteristics. Active antennas have in general higher gain and are the best solution in weak-signal environments. Passive antennas have the advantage that no dedicated power supply is needed. Module EV-Board shows the integration of an active and a passive antenna and serves as reference design. On the EV-board, it is possible to select either external SMA connection to an active antenna or to an integrated passive antenna. This allows comparing module's behavior with different antenna variants.

Also, please refer to our application note on GNSS antennas [1], which provides extensive recommendations and guidelines to select the right antenna solution.

Following factors and tasks are critical for the performance of the GNSS module:

- GNSS antenna selection, integration and matching
- Quality of the RF design from the GNSS antenna to Elara-II
- Minimization of external and environmental effects

Please refer to our hardware layout recommendations (chapter 7).



In the same perspective, be aware that the external antenna shall foresee the freest possible view of GNSS satellites.

Description	Value
Antenna Connector Type	RF pad

Table 5: Antenna connector Type

Description	Min	Typ.	Max	Unit
Input Frequency	1560		1620	MHz
Impedance at 1575.5 MHz		50		Ω
Return Loss at 1575.5 MHz	-7			dB

Table 6: Radio characteristics

2.5 Pin characteristics

Property	Min	Typ.	Max	Unit
GPIO Voltage Input high	$0.70 \times VCC$		3.6	V
GPIO Voltage Input low	-0.3		0.4	V
GPIO Voltage Output high	$0.75 \times VCC$			V
GPIO Voltage Output low			0.4	V
Internal Pull-down resistor	110	1000	2800	Ω
Input Leakage Current	-10		10	μA
Output Leakage Current	-10		10	μA
Input Capacitance		5		pF

Table 7: Pin characteristics

3 GNSS performances

This chapter describes the GNSS behavior of the module. Several GNSS performance indicators are statistical in nature, which intends that the given values are obtained as mean value over a large number of measurements under laboratory conditions.

3.1 Satellite constellations supported

Position calculation is based on one-way signal transmission from navigation satellites flying at around 20000 km altitude from ground. These satellites compose global (GNSS) and regional (RNSS) constellations.

Currently existing GNSS are GPS (US), GLONASS (Russia), Galileo (Europe), and BeiDou (China). These systems are interoperable: satellites from different constellations can be tracked simultaneously by the GNSS module (multi-GNSS). This increases robustness and overall performance of GNSS positioning, and becomes particularly important in obstructed environments (e.g. urban canyons).

Elara-II supports GPS and GLONASS.

Supported GNSS	Frequency Band	Center Frequency	Active by default
GPS	L1	1575.42 MHz	Yes
GLONASS	L1	1602 MHz	Yes

Table 8: GNSS constellations supported

Additional ranging signals are provided by the Japanese regional system QZSS, which serves as enhancement of GPS in the Asia-Oceania region, with focus on Japan. SBAS also provides additional ranging signals, together with correction data.

Supported system	Frequency Band	Function	Active by default
QZSS	L1	Ranging	Yes
SBAS	L1	Corrections and ranging	Yes

Table 9: Additional systems supported

GPS and GLONASS, as well as QZSS and SBAS, are active by default. Changing the set of active systems can be done through software command (refer to MID 222,16 of the OSP protocol, described in chapter 10).

3.2 Accuracy

3.2.1 Position Accuracy

Parameter	Mode	Value	Unit	Test conditions
Horizontal Position Accuracy	GPS-only	2.5	m	Static, VCC = 1.8V, power level = -130 dBm, T=25°C, CEP(50%)
	GPS-GLO	1.5	m	

Table 10: Horizontal Position Accuracy

Parameter	Mode	Value	Unit	Test conditions
Vertical Position Accuracy	GPS-only	4	m	Static, VCC = 1.8V, power level = -130 dBm, T=25°C, 50% of trials
	GPS-GLO	2.5	m	

Table 11: Vertical Position Accuracy

3.2.2 Velocity Accuracy

Parameter	Value	Unit	Test conditions
Speed Over Ground Accuracy	0.1	m/s	VCC = 1.8V, power level = -130 dBm, T=25°C, v<30 m/s, 50% of trials

Table 12: Velocity Accuracy

3.2.3 Heading Accuracy

Parameter	Value	Unit	Test conditions
Heading Accuracy	0.3	°(from North)	VCC = 1.8V, power level = -130 dBm, T=25°C

Table 13: Heading Accuracy

3.2.4 Time Accuracy

Best time synchronization is obtained using the PPS signal (see section 4). The accuracy defined here is the delay between the PPS pulse and the UTC epoch. In case a software message is used for synchronization, the delay between the PPS signal and sending out the message should also be taken into account.

Parameter	Value	Unit	Test conditions
Timing Accuracy	30	ns	VCC = 1.8V, power level = -130 dBm, T=25 °C

Table 14: Time Accuracy

3.3 Time To First Fix

The Time To First Fix (TTFF) is the time needed by the module to achieve the first valid position fix, once the module is powered up or returns from a period of signal blockage.

Depending on the type of start (hot, warm, cold, see chapter 6), different TTFF performance is given.

Parameter	Start Type	Mode	Value	Unit	Test conditions
Time To First Fix	Hot start		1	s	Static, VCC = 1.8V, power level = -130 dBm, T=25 °C, average or 50% of trials
	Warm start	GPS-only	30	s	
		GPS-GLO	27.5	s	
	Cold start	GPS-only	32	s	
		GPS-GLO	28	s	

Table 15: Time To First Fix

3.4 Sensitivity

Module sensitivity is the weakest signal level the receiver can work with and it depends on the state of the module.

- Acquisition sensitivity is the minimum power required by the module to acquire satellites and perform first fix.
- Navigation sensitivity is the minimum power required by the module maintain a position fix.
- Tracking sensitivity is the minimum power required by the module to keep in track of at least one satellite, regardless of the position fix.
- Reacquisition sensitivity is the minimum power required by the module to reobtain the position fix after a temporary RF blockage.



The ultra-high sensitivity of the module increases robustness to obstructed environments. On the other hand, please note that optimal performance are obtained under open sky conditions (no obstacles).

Parameter	Mode	Value	Unit
Acquisition sensitivity	GPS	-148	dBm
Reacquisition sensitivity	GPS	-158	dBm
Navigation sensitivity	GPS	-161	dBm
Tracking sensitivity	GPS	-164	dBm

Table 16: Sensitivity

3.5 Dynamic constraints

The following table describes limits and constraints which apply to Elara-II module.

Parameter	min	max	Unit	Test condition
Altitude	-500	24000	m	velocity < 514 m/s
		18000	m	velocity > 514 m/s or acquisition
Velocity		600	m/s	altitude < 18288 m
		514	m/s	altitude > 18288 m
Acceleration		4	g	
Jerk		5	m/s ³	

Table 17: Dynamic Constraints

4 Pinout

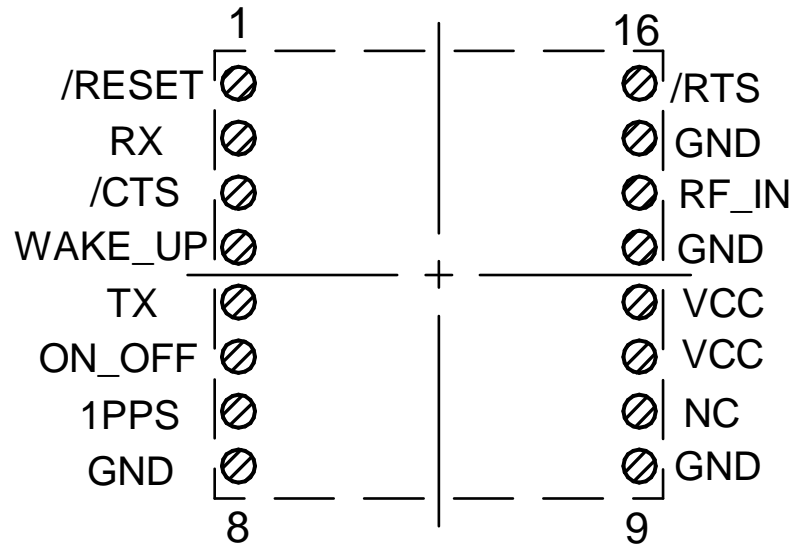

Figure 3: Pinout (top view)

No	Designation	I/O	Description
1	<i>/RESET</i>	Input	Reset
2	<i>RX</i>	Input/Output	Receive
3	<i>/CTS</i>	Input/Output	Clear to send signal
4	<i>WAKE_UP</i>	Output	Operation mode status
5	<i>TX</i>	Input/Output	Transmit
6	<i>ON_OFF</i>	Input	Power State Control
7	<i>1PPS</i>	Output	UTC Time Mark
8	<i>GND</i>	Supply	Negative supply voltage
9	<i>GND</i>	Supply	Negative supply voltage
10	<i>NC</i>	–	Not connected
11	<i>VCC</i>	Supply	Positive supply voltage
12	<i>VCC</i>	Supply	Positive supply voltage
13	<i>GND</i>	Supply	Negative supply voltage
14	<i>RF_IN</i>	Input	RF Signal Input
15	<i>GND</i>	Supply	Negative supply voltage
16	<i>/RTS</i>	Input/Output	Request to send signal

Table 18: Pinout

Specific pin connection for UART, I²C and SPI interfaces is described in the tables below.

Pin number	Designation	I/O	Description
2	<i>RX</i>	Input	UART Receive
3	<i>/CTS</i>	Input	UART Clear to send signal
5	<i>TX</i>	Output	UART Transmit
16	<i>/RTS</i>	Output	UART Request to send signal

Table 19: Pinout - UART communication

Pin number	Designation	I/O	Description
2	<i>RX</i>	Input/Output	I ² C data
5	<i>TX</i>	Input/Output	I ² C clock

Table 20: Pinout - I²C Multi Master communication

Pin number	Designation	I/O	Description
2	<i>RX</i>	Input	MOSI, SPI Data In (MO)
3	<i>/CTS</i>	Input	SPI Clock (SCLK)
5	<i>TX</i>	Output	MISO, SPI Data Out (MI)
16	<i>/RTS</i>	Input	SPI Chip Select (CS_N)

Table 21: Pinout - SPI slave communication

4.1 ON_OFF pin

Connection of *ON_OFF* pin to host is mandatory for module operation. *ON_OFF* pin allows changing of module's power state according to the following table.

Initial state	Final state
Hibernate	Full Power
Full Power	Hibernate
Push To Fix	Full power (until position fix is obtained)
Trickle Power	Full Power

Table 22: ON_OFF pin function

Recommended length of pulse is 100 ms. Detection of low and high logic levels after trigger requires the new logic level to persist at least 100 μ s. Do not perform any of the following actions:

- do not trigger for less than 100 μ s

- do not trigger multiple times with less than 1 second interval
- do not drive high permanently
- do not pull-up

Pull-down resistor of 10-33 k Ω is recommended to avoid untriggered power state change.

4.2 WAKE_UP pin

Connection of *WAKE_UP* pin is not mandatory for module operation. It indicates module's operating power state according to the following table.

Logic level	Power state
Low	Hibernate
High	Full Power

Table 23: WAKE_UP pin function

WAKE_UP output is LVCMOS 1.8V compatible and can be used to control external devices, provided the logic level and GPIO current are supported. Connecting WAKEUP to ON_OFF enables autonomous start to Full Power state.

Do not connect if not used.

4.3 /RESET pin

Connection of */RESET* pin is not mandatory for module operation. It is triggered by applying a low level pulse, has internal pull-up resistor of 1 M Ω , and signal shall be applied for at least 1 μ s. Power-On-Reset (POR) sequence is generated internally.

Please do not perform any of the following actions:

- do not drive high
- do not connect if not used

4.4 1PPS pin

Connection of *1PPS* pin is not mandatory for module operation. It provides a pulse signal for precise timing, as it is synchronized with the UTC time epoch with 30 ns accuracy. It starts once the module obtains a 3D position fix based on at least 5 GNSS satellites. If this condition is lost, PPS output stops.

After pulse is generated, UTC time is reported in the NMEA ZDA message. This message is the one sent with shortest time delay with respect to the real UTC time and should be used whenever software-based time synchronization is foreseen in the application.

1PPS is LVCMOS 1.8V compatible and pulse length is 200 ms with rising edge of less than 30ns.

Do not connect if not used.

4.5 /RTS and /CTS pins

/CTS and */RTS* states are active low and define the interface used for communication (see chapter 9).

5 Quick start guide

The Elara-II GNSS module comes pre-flashed, tested and ready-to-use out-of-the-box. This chapter describes the steps to quickly build a prototype system and test the capabilities of the module.

5.1 External GNSS antenna

The Elara-II has a RF pad for connection of an external GNSS antenna. Module EV-Board includes two ready-to-use selectable antenna options allowing getting started with Elara-II without previous effort for RF design.

5.2 Minimal pin configuration

The following pins must be connected as described in the following table for correct operation. Remaining pins can be left unconnected. With this configuration the UART will be selected as communication interface and will be running in 4800 Baud 8n1 as default.

Pin Number	Pin Function	Pin connection
2	<i>RX</i>	Host TX
3	<i>/CTS</i>	external pull-up required, UART flow control during application
5	<i>TX</i>	Host RX
6	<i>ON_OFF</i>	Host GPIO for power state selection
8	<i>GND</i>	<i>GND</i>
12	<i>VCC</i>	Power supply
16	<i>/RTS</i>	UART flow control during application

Table 24: Minimal pin configuration, UART mode

Use of */CTS* and */RTS* defines the interface (UART, I²C or SPI) for communication with the host (see chapter 9).

For further information about pin configuration, refer to chapter 4.

5.3 Power up

After first power up, module boots to hibernate state. If */RESET* is left unconnected, it is asserted to high level automatically after power up. In order for RTC to start and for *WAKE_UP* pulse to occur, */RESET* pin must be in high level. *WAKE_UP* pulse indicates that the module is in ready-to-start state.

From ready-to-start state, the module can be driven to full power state through a low-high-low pulse on the *ON_OFF* pin.

Once transition to full power state is complete, Ok-To-Send message \$PSRF150,1*3E is sent out by the module (refer to chapter 10).



If *WAKE_UP* and *ON_OFF* pins are connected, the module goes by default into full power state, without pulse on *ON_OFF* pin needed.

Further details are shown in the picture and table below.

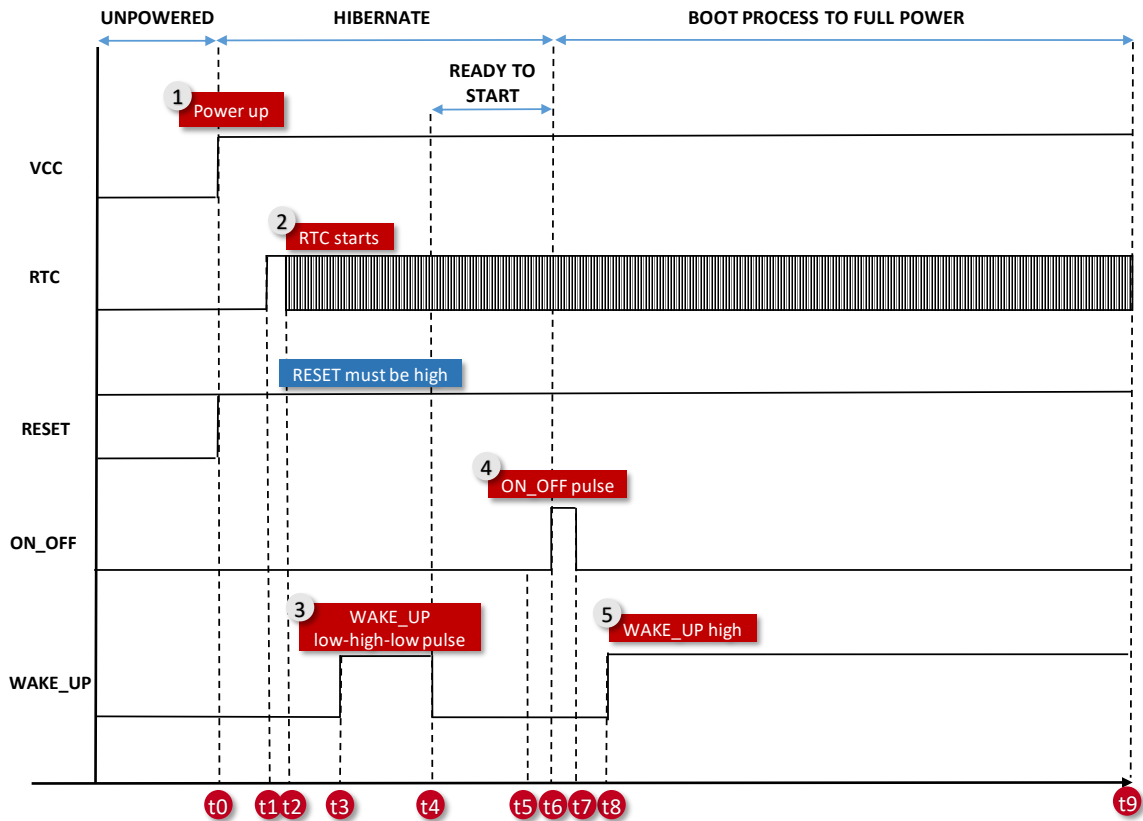

Figure 4: Power up

Symbol	Event/parameter	Value	Unit
f_{RTC}	RTC frequency	32768	Hz
t_{RTC}	RTC Tick	30.5176	μs
t_2-t_1	RTC startup time	300 (typ)	ms
t_2-t_0	Power stabilization	$7 * t_{\text{RTC}} + (t_2-t_1)$	μs
t_4-t_3	<i>WAKE_UP</i> pulse	10 (typ)	t_{RTC}
t_6-t_5	<i>ON_OFF</i> low	3 (min)	t_{RTC}
t_7-t_6	<i>ON_OFF</i> high	3 (min)	t_{RTC}
t_8-t_6	<i>ON_OFF</i> to <i>WAKE_UP</i> high	6 (typ)	t_{RTC}
t_9-t_6	boot process to full power	2130 (typ)	t_{RTC}

Table 25: Startup timing

5.4 Acquisition, first fix, and tracking

When powered up, the module enters hibernate state by default.

In this state the module:

- does not track navigation signals;
- does not compute position;
- is not able to receive or send commands to the host

For applications where infrequent positioning is required, this state can be set to achieve minimum power consumption for the module, until new position fix is needed.

When brought to full power through the *ON_OFF* pin, the module starts searching for GNSS satellite signals (acquisition) on its available channels in order to compute the first position. Only satellites corresponding to the default constellation settings (GPS, GLONASS) are searched. In full power state, the module sends out messages automatically according to the default protocol (NMEA) and update rate (1 Hz) and is able to receive messages from the host and react. This phase corresponds to the maximum power consumption of the module.

Once at least 3 GNSS satellites are tracked, the receiver returns the first position fix (2D). Once at least 4 GNSS satellites are tracked, 3D position fix is achieved. The time needed to provide first valid position (2D or 3D) is called Time To First Fix (see section 3.3).

After first fix, the receiver enters tracking conditions. In this phase, navigation as well as communication with the module are possible. The receiver keeps searching for GNSS satellites to acquire. A higher number of tracked satellites improves accuracy and stability of the positioning.



During tracking, further information about the satellite constellations (almanac) are downloaded from the GNSS satellites. This leads to a higher power consumption. At the end of the download phase (that takes approximately 15 minutes), a drop in the current consumption can be observed.

Within this download phase, the receiver updates the leap seconds count with the value reported in the incoming satellites signal. This allows the module to convert correctly between GPS time and UTC time. Before that and if GPS is used, the UTC time reported by the Elara-II module is 2 seconds ahead.

After stable tracking conditions are achieved, low power modes can be activated through software commands.



A new pulse on the *ON_OFF* pin brings the module back from full power to hibernate state.

Mode of Operation	Tracking Navigation Signals	Compute Position	Receive/Send Command from/to host	Power Consumption
Hibernate	NO	NO	NO	LOW
Full Power	YES	YES	YES	HIGH

Table 26: Module Mode of Operation

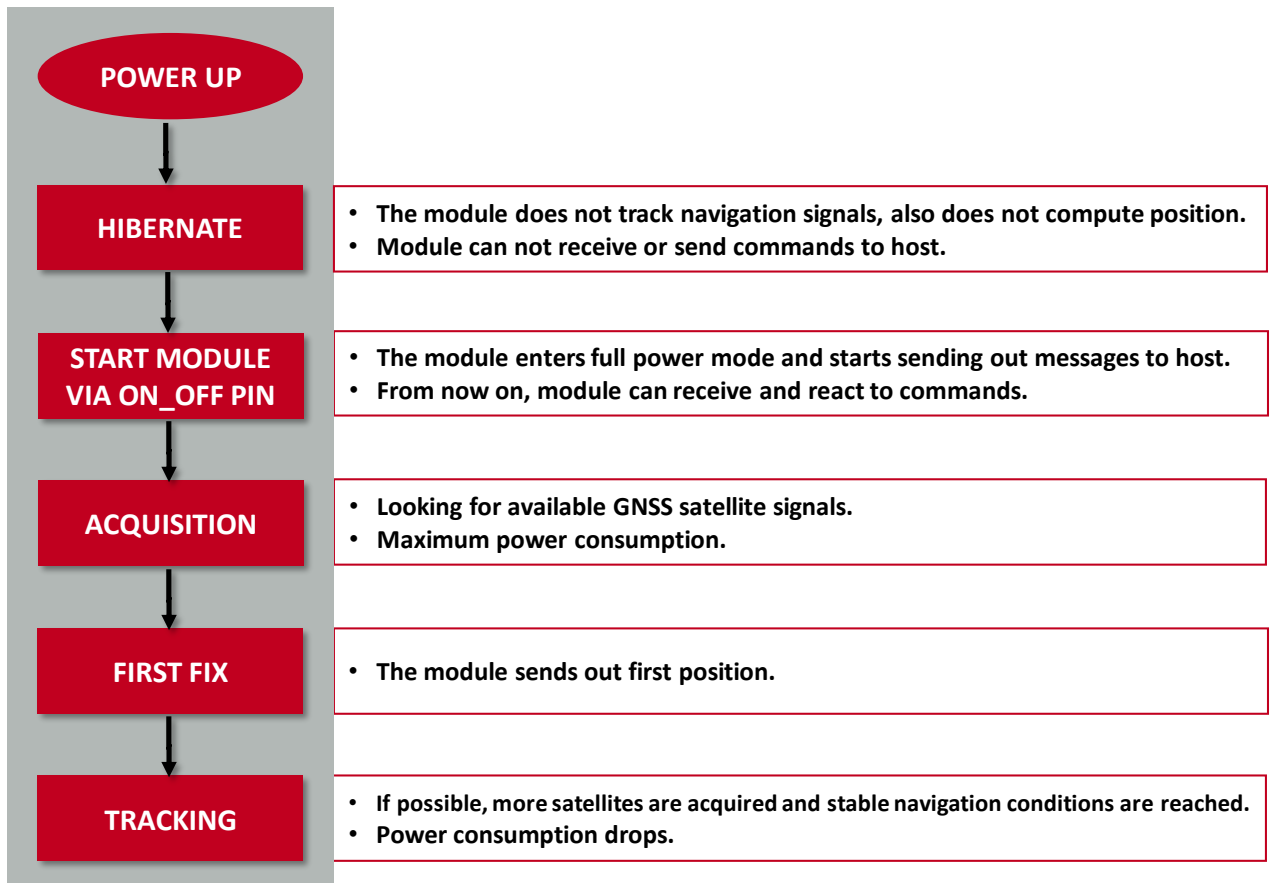

Figure 5: Elara-II (Module Start-up)

5.5 Quick start example

It is recommended to use the Elara-II evaluation kit [9] and WENSS PC tool [8] for putting the GNSS module into operation. Passive and active antenna options are available for antenna connection. Please refer to the evaluation board [3] and WENSS PC tool user manual for detailed information.

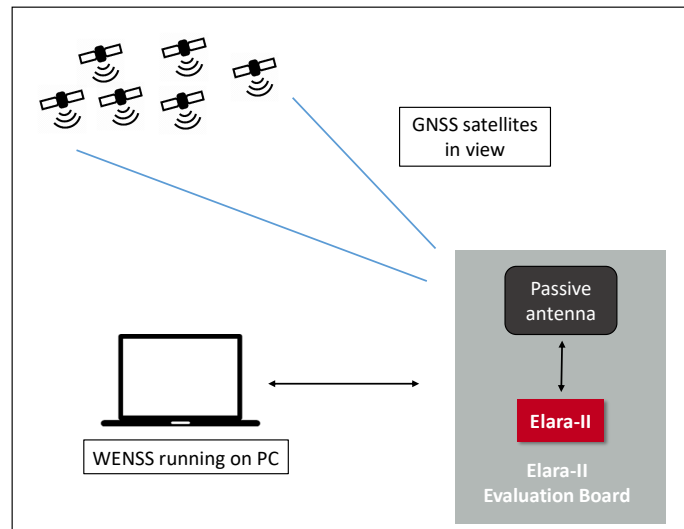

Figure 6: Elara-II - Quick start setup (passive antenna)

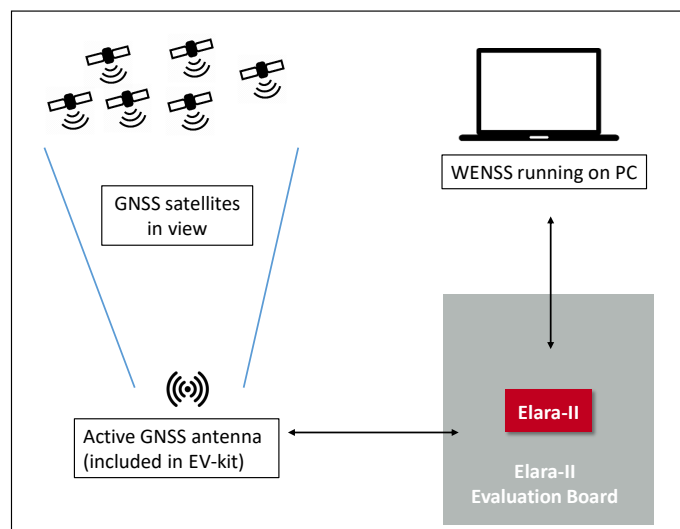

Figure 7: Elara-II - Quick start setup (active antenna)



Be sure that GNSS satellites are in view. Typically this is not possible inside buildings!

6 Functional description

Elara-II GNSS module is meant to be integrated in systems where position, velocity, and time information are needed. When in full power mode, the module sends out sentences containing this information to the host. Validity and accuracy of these data depends on the quality of the link established with the GNSS satellites.

Use and/or further path of these data has to be built-up and configured on host side.

Information	Values
Position	Latitude
	Longitude
	Altitude (MSL and WGS84)
Time	Coordinated Universal Time (UTC)
Motion	Course (heading from North)
	Speed over ground

Table 27: PVT data

These messages are sent from the module according to the following communication parameters:

Parameter	Value
Communication interface	UART, I ² C, SPI
Communication protocol	NMEA or OSP
Baud rate	4800 , 9600, 19200, 38400, 57600, 115200, 230400, 460800, 921600, 1228800
Update rate	1 Hz or 5 Hz
Single message rate	1 to 255 seconds

Table 28: Communication Settings

The data rate used must be larger than the amount of data sent out by the module. This depends on the protocol, the active messages and the update rate. In Elara-II typical configuration (UART 4800 baud, NMEA) the amount of messages was selected according to the communication interface speed. In general, when working with OSP and/or with update rates greater than 1 Hz, switching from the default data rate to a higher data rate is mandatory in order to avoid loss of data.



Communication interface and data rate between the host and module must comply with each other



Default communication parameters values are defined in the firmware. After power up or factory reset, module returns to these settings

6.1 Cold, warm, and hot start

Different types of start are defined for GNSS receivers. They are performed according to available data which might support and shorten acquisition phase until first fix. The type of start depends on the following data.

- satellite ephemeris:
set of data containing prediction of GNSS satellites orbit, valid for max. 4 hours.
- valid position estimate
(within 100 km from true position)
- valid time estimate

These data result from user injection or from previous tracking conditions.

- **Cold start**
Module needs to perform a sky search to acquire GNSS satellites without any known information or estimate. Complete re-learning of satellite data and ephemeris download is needed in order to compute first position.
- **Warm Start**
In warm start conditions, valid position and time estimates are known. Complete re-learning of satellite data and ephemeris download is needed.
- **Hot Start**
In hot start, position and time estimates, as well as satellite ephemeris, are available.

	Valid position estimate	Valid time estimate	Valid satellite ephemeris
Cold Start	Not known	Not known	Not known
Warm Start	Known	Known	Not known
Hot Start	Known	Known	Known

Table 29: Cold, Warm and Hot Start

6.2 Low power modes

Power saving in Elara-II is accomplished by setting the module in hibernate state during time slots when a new position fix is not required. Therefore, all power saving modes are based on scheduling low and full power states for the GNSS module at variable rates.

When in hibernate, the module maintains configuration and critical data (f.e. clock synchronization) which are used for faster reacquisition once the module returns to full power state. If the module stays in hibernate for more than 4 hours, satellite ephemeris expires and a new download is needed at wake up for position fix.

If the module is not needed for a longer phase, complete un-powering of the module shall be considered to achieve zero power consumption. In this case, all critical data and settings are lost. Complete re-learning of satellite data, time and location is needed at power up.

6.2.1 Host-controlled low power mode

The module can be set to hibernate state by triggering the ON_OFF pin or by software command (see chapter 10). Triggering the ON_OFF again sets the module back to full power. This means that a schedule of hibernate and full power time slots can be defined on host side according to the application. Alternatively, the host can wake up the module when a specific event occurs. If needed, this mechanisms have to be implemented on host side.

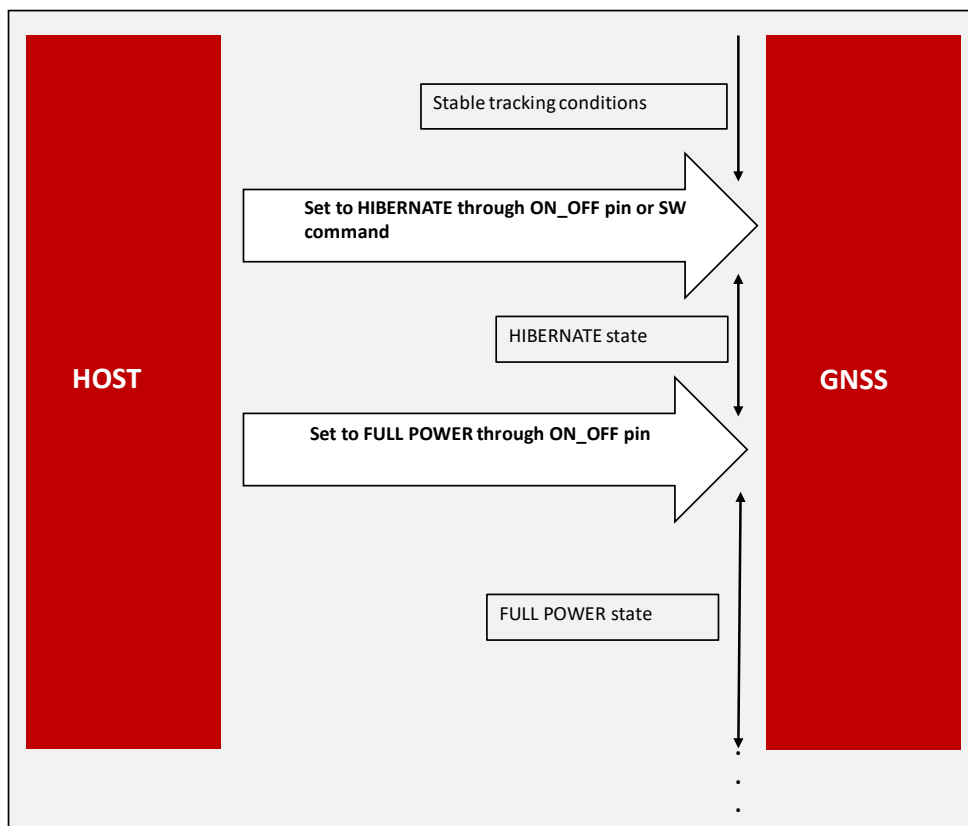

Figure 8: Host Based Low Power Mode

6.2.2 Self-managed low power modes

The module offers different self managed low power modes, which automatically switch between hibernate and full power according to a configurable time schedule. Please note that:

- self managed low power modes shall be activated from stable tracking conditions, since update of the position has to be performed in a short full power time slot;
- in general, degradation of position accuracy has to be expected when using low power modes.

6.2.3 Push To Fix

Push To Fix is the recommended low power mode when infrequent navigation solution is required.

It consists of alternating longer sleep times (PTF period) and short acquisition attempts (maximum duration defined by MAX_SEARCH_TIME). If a position fix could not be obtained during MAX_SEARCH_TIME, the module goes to hibernate for a time defined by MAX_OFF_TIME, before waking up and trying again. During sleep time, a new acquisition attempt can be requested by triggering the ON_OFF pin.

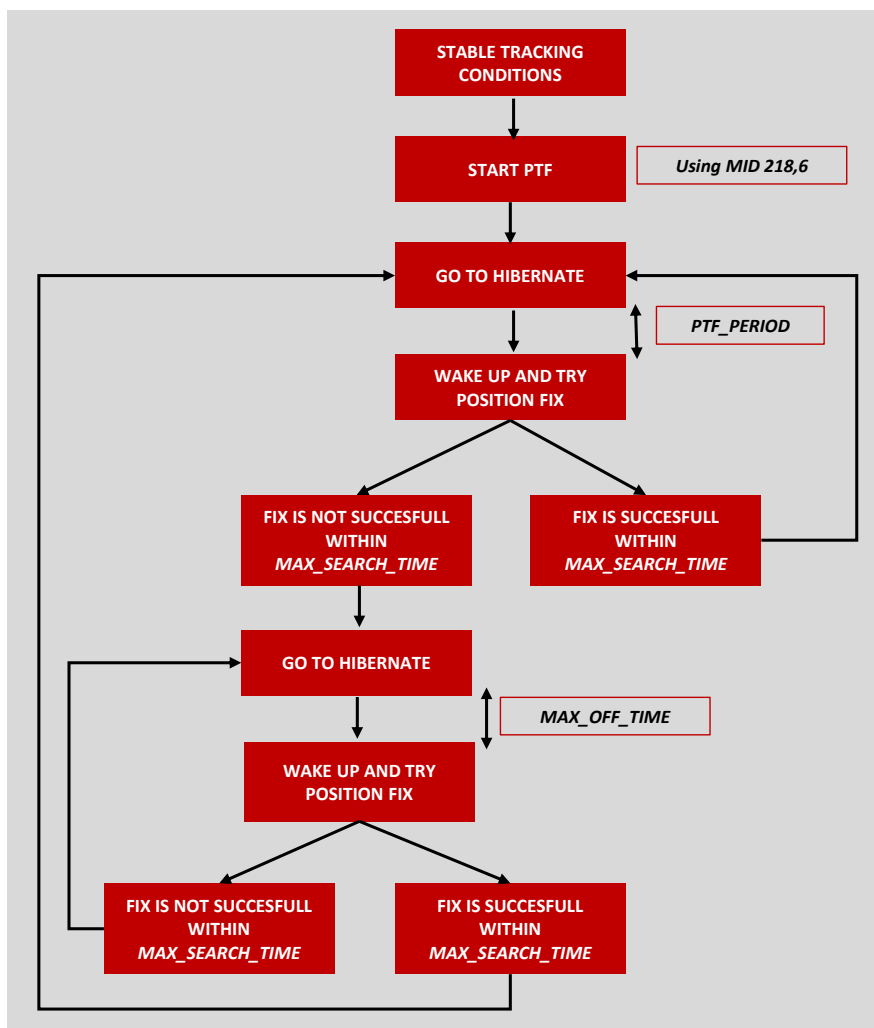

Figure 9: Push To Fix

Figure 10 shows a diagram of Push To Fix current consumption profile.

Please see chapter 10 (MID 218,6) for configuration of PTF.

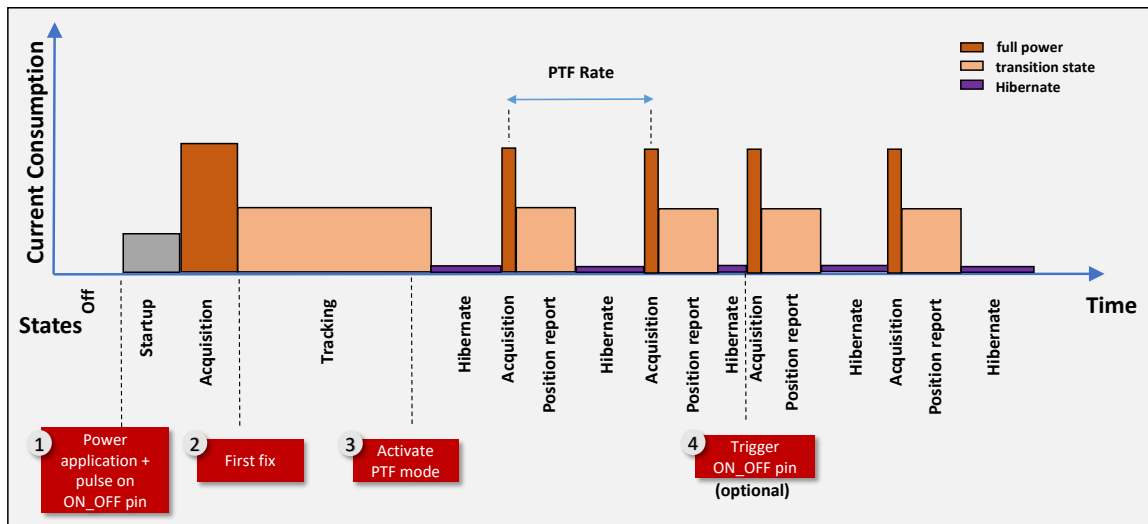

Figure 10: Push-To-Fix Current Consumption Profile

6.2.4 Trickle Power mode

Trickle power is the recommended state when positioning is required:

- at a fixed rate;
- with low power consumption
- with the ability to track weak signals retained

In Trickle Power mode, the receiver cycles between full power (RF and CPU on), CPU-only mode, and STANDBY according to a configurable rate. At wake up, GNSS signals are recorded (RF on), then position fix is computed during CPU-only state. Similarly to PTF, the parameter MAX_SEARCH TIME defines how long the receiver tries to compute position during the full power time slots. MAX_OFF_Time defines how long the receiver stays in sleep mode, if no position fix could be computed during MAX_SEARCH_TIME.



In weak-signal environment, the receiver switches to full power automatically.

Figure 11 shows a diagram of Trickle Power current consumption profile.

Please refer to chapter 10 (MID 218,6) for configuration of Trickle Power mode.

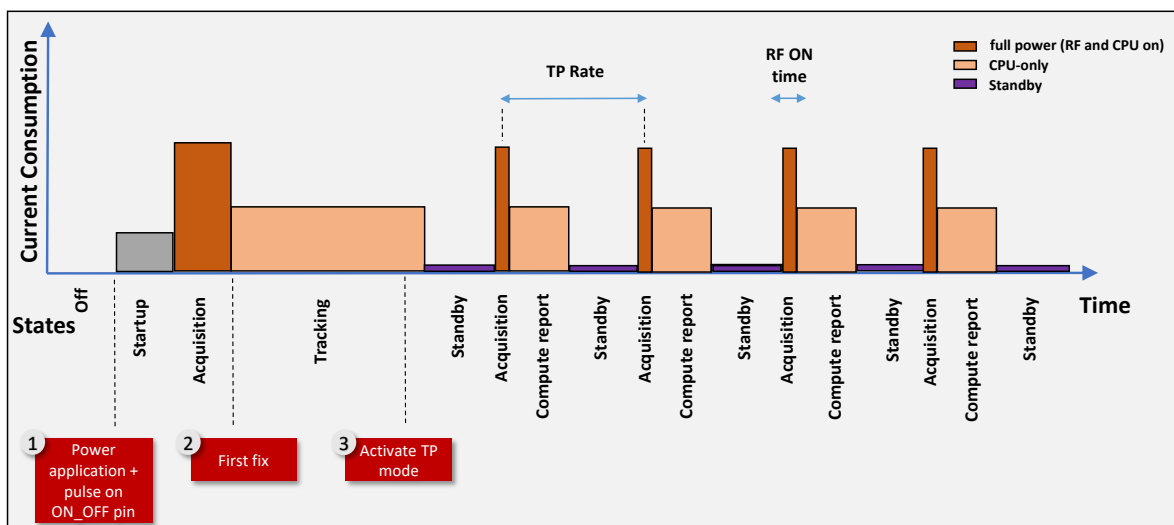

Figure 11: Trickle Power Mode Current Consumption Profile

7 Design in guide

7.1 Advice for schematic and layout

For users with less RF experience it is advisable to closely copy the related evaluation board [3] with respect to schematic and layout, as it is a proven reference design. The layout should be designed with particular care, because even small deficiencies could affect the radio performance and its range or even the conformity.

The following general advice should be taken into consideration.

Power Supply

- A clean, stable power supply is strongly recommended. Interference, especially oscillation can severely restrain range and conformity.
- Variations in voltage level should be avoided.
- A dedicated LDO should be used to power the module and placed close to the VCC pad.
- Blocking capacitors (e.g. WCAP-CGSP product family) and a ferrite bead (e.g. WE-CBF product family) in the power supply line can be included to filter and smoothen the supply voltage when necessary. These components should be placed as close as possible to the VCC pad of the radio module.



No specific blocking capacitors and ferrite bead values can be recommended, as these depend on the types of interferences, ripples or disturbances.



The use of an external reset IC should be considered if one of the following points is relevant:



- The slew rate of the power supply exceeds the electrical specifications.
- The effect of different current consumptions on the voltage level of batteries or voltage regulators should be considered. The module draws higher currents in certain scenarios, which might lead to a voltage drop on the supply. In such scenarios, the reset IC voltage should be chosen as high as the static (battery) voltage from which it is known to break down below the module's minimum supply voltage (VCCmin). This would avoid events like module improper start up, voltage break down and restarting.
- Voltage levels below the minimum recommended voltage level may lead to malfunction. The /Reset pin of the module shall be held on LOW logic level whenever the VCC is not stable or below the minimum operating voltage.
- Special care must be taken in case of battery powered systems.

ESD Protection

- Elements for ESD protection should be placed on all pins that are accessible from the outside and should be placed close to the accessible area. For example a voltage suppression diode (e.g. WE-TVS product family) should be implemented near the USB connector for ESD protection.
- ESD protection for the antenna connection must be chosen such as to have a minimum effect on the RF signal. For example, a protection diode with low capacitance (e.g. WE-VE femtoF product family) connecting the RF-line to ground give good results.
- ESD protection device should be placed on the pins that may influence the module's operation. For example, an accidental trigger on the *ON_OFF* and */RESET* may cause a module reset. It could be avoided by placing 1nF blocking capacitor.



No specific values can be recommended, as they depend on the influencing circumstances of the application (antenna, interferences etc.).

7.1.1 Footprint

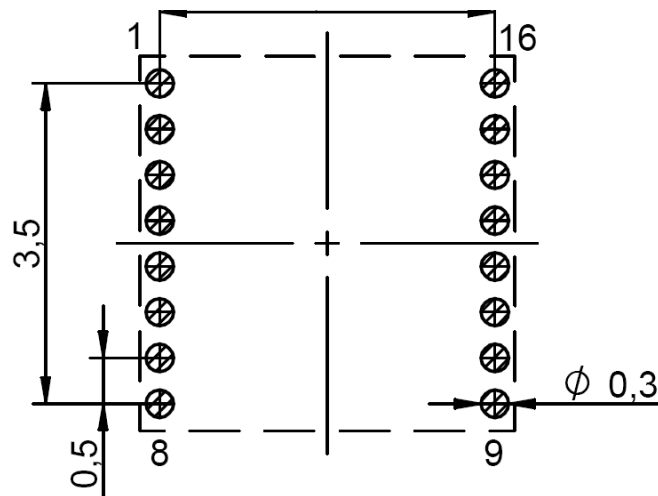

Figure 12: Footprint Design

The footprint of the module shall be connected to the extensive GND plane on the second layer with 4 x 0.3 mm drill ground plane vias, shown as green circles on Figure 13.

It is recommended to use the libraries from Würth Elektronik eiSos for hardware design as they already include the necessary implementation [6] [7].

7.1.2 Module Footprint on PCB

It is recommended to design a keep out area of minimum 3mm around the module. It is highly recommended to avoid placing other components in the keep out area as shown in Figure 13.

Blocking capacitors should be placed close to the VCC pin of the module, which is an exception to the keep out area.

Filter and decoupling capacitors should be placed directly in the tracks without stubs, to achieve the best effect.

Any component having a ground connection should be directly connected to the ground plane. So it is recommended to use a separate via connection to ground plane by placing the via close to the components.

The antenna path should be kept as short as possible.

Antenna matching elements should be placed close to the antenna / connector.

Place holders for optional antenna matching or additional filtering are recommended.

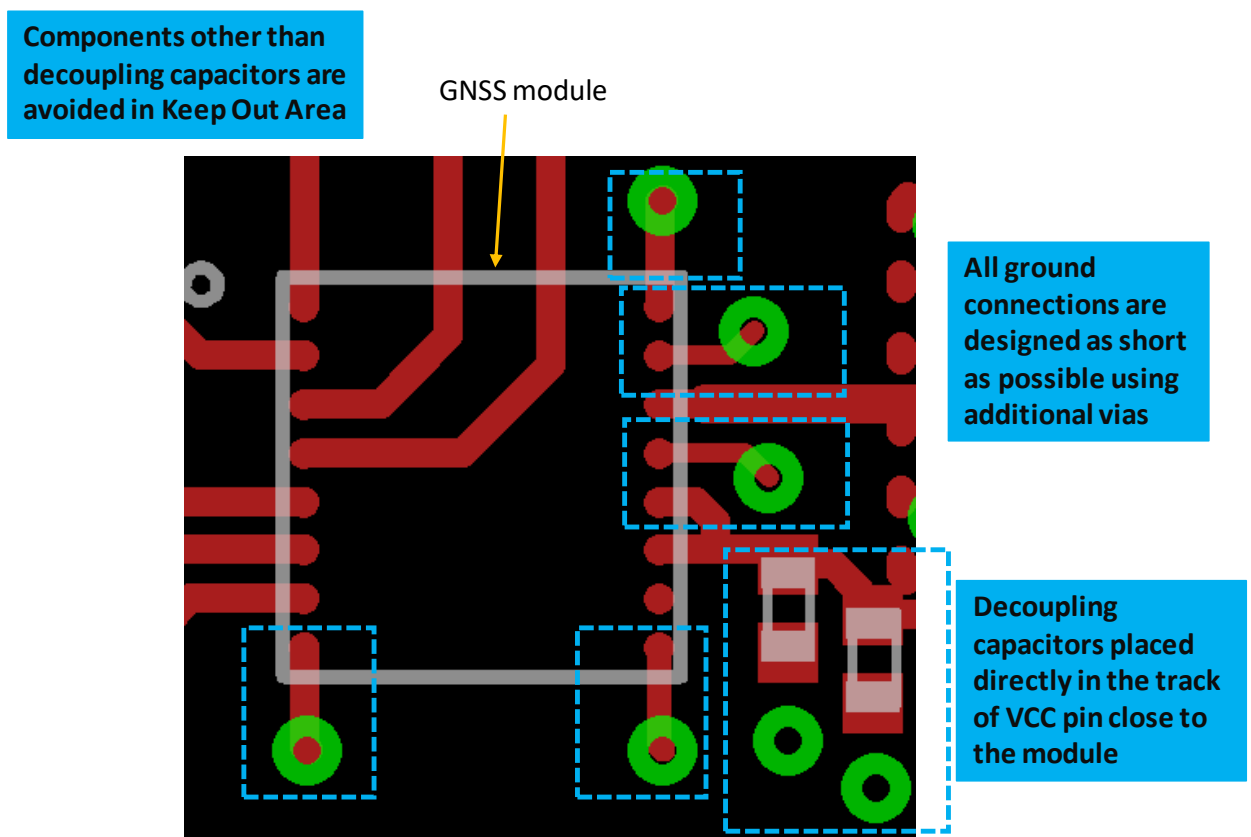

Figure 13: Layout Design

7.1.3 PCB Stackup

On the top layer, signal routing is recommended. On the third layer, signal as well as power routing can be designed.

On the second and bottom layer, a ground plane is recommended, to provide good grounding and shielding to any adjacent layers as well as application environment. The bottom layer functions as the main ground plane which has to be connected to the second layer using vias.

The ground plane on second layer should at least cover the filter and blocking devices and has to be connected to the main ground layer using vias.

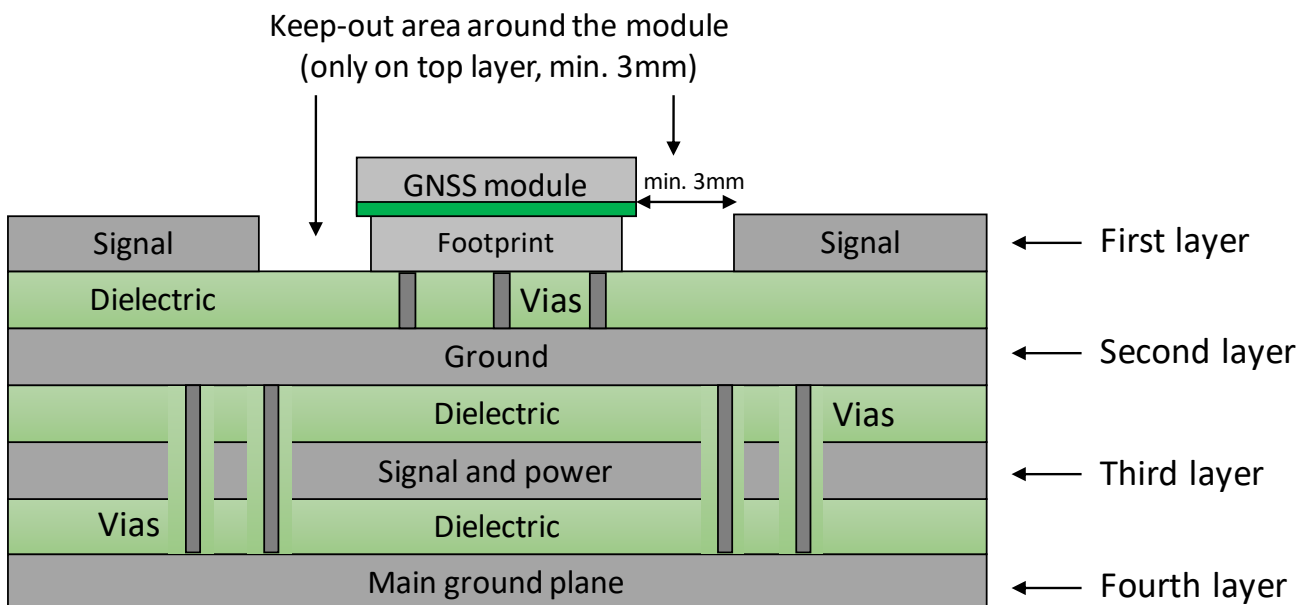

Figure 14: Stackup

7.1.4 Module's placement

The GNSS module should be positioned in the center of the board to have symmetrical or nearly symmetrical ground distribution as shown in the Figure 15.

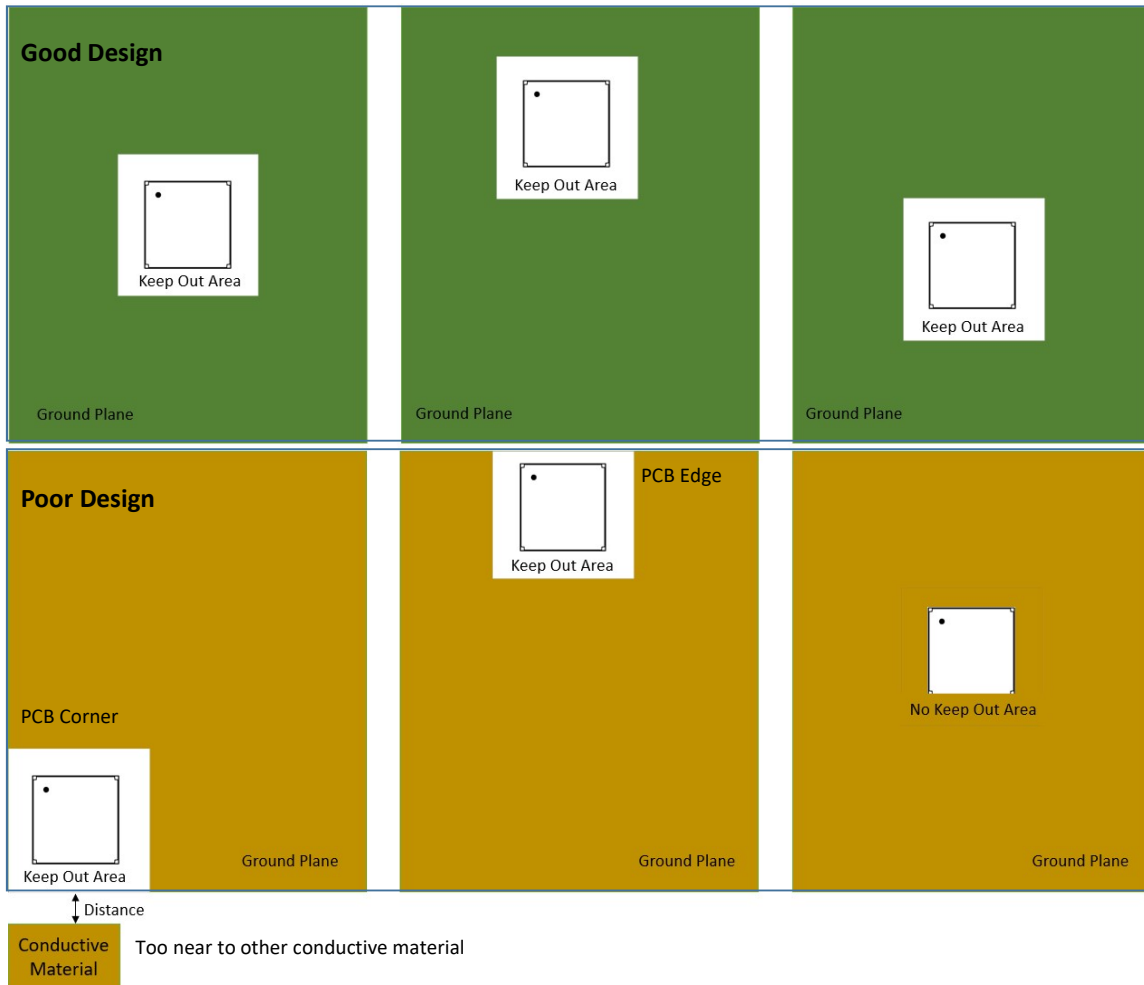

Figure 15: Placement of the module

7.1.5 Assembly Information

For proper assembly of module on the host PCB, the recommended soldering parameters given below shall be followed.



Solder stencil thickness:	max. 100 μm
Solder stencil opening:	80 % to 100 %
Solder stencil type:	Electroformed or Laser cut stencil
Solder paste type:	Type 4.5 to Type 6
Peak reflow temperature:	245 $^{\circ}\text{C}$

7.2 Dimensioning of the micro strip antenna line

The antenna track has to be designed as a 50Ω feed line. In the following, calculation of the type "micro strip line" is described. An other possibility would be to use a coplanar line.

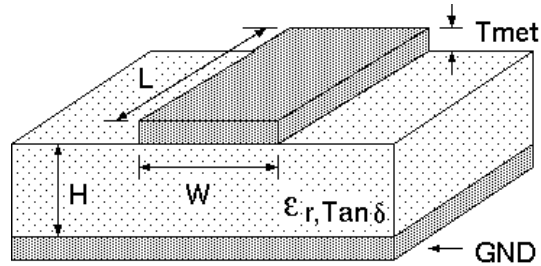

Figure 16: Dimensioning the antenna feed line as micro strip

The width W for a micro strip can be calculated using the following equation:

$$W = 1.25 \times \left(\frac{5.98 \times H}{e^{\frac{50 \times \sqrt{\epsilon_r + 1.41}}{87}}} - T_{met} \right) \quad (1)$$

Example:

A FR4 material with $\epsilon_r = 4.3$, a height $H = 1000 \mu\text{m}$ and a copper thickness of $T_{met} = 18 \mu\text{m}$ will lead to a trace width of $W \sim 1.9 \text{ mm}$. To ease the calculation of the micro strip line (or e.g. a coplanar) many calculators can be found in the internet.

- As rule of thumb a distance of about $3 \times W$ should be observed between the micro strip and other traces / ground.
- The micro strip refers to ground, therefore there has to be the ground plane underneath the trace.
- Keep the feeding line as short as possible.

7.3 Antenna solutions

There exist several kinds of antennas, which are optimized for different needs. Chip antennas are optimized for minimal size requirements but at the expense of range, PCB antennas are optimized for minimal costs, and are generally a compromise between size and range. Both usually fit inside a housing.

Higher received signal strength is in general at the expense of space. Antennas that are bigger in size, which would probably not fit in a small housing, are usually equipped with a RF connector. A benefit of this connector may be to used to lead the RF signal through a metal plate (e.g. metal housing, cabinet).

As a rule of thumb a minimum distance of $\lambda/10$ (which is 1.9 cm @ 1.575 GHz) from the antenna to any other metal should be kept. Metal placed further away will not directly influence the behaviour of the antenna, but will anyway produce shadowing.



Keep the antenna as far as possible from large metal objects to avoid electromagnetic field blocking.

Please refer to our application note [1] for further information and recommendations on GNSS antenna selection.

GNSS antennas from Würth Elektronik are described in the following chapters.

7.3.1 Antennas provided by Würth Elektronik eiSos

7.3.1.1 2600130016 - GNSS Active antenna



Figure 17: GNSS Active antenna

Specification	Value
Frequency range [MHz]	1575.42MHz \pm 5MHz 1610MHz \pm 10MHz
Impedance [Ω]	50
VSWR	≤ 2
Peak Gain [dBic]	5 (min)
Axial Ratio [dB]	2 (max)
Polarization	R.H.C.P.
LNA Gain [dB]	30 (typ)
LNA Noise Figure [dB]	1.5 (max)
Cable insertion loss [dB/m]	1.2 (typ)
DC Voltage [V]	3 - 5
DC Current [mA]	11.5 (typ) @ 3V
Dimensions (L x W x H) [mm]	48.6 x 39.2 x 15.2
Weight [g]	106
Mounting	Magnet Base
Cable type	RG-174
Cable Length [m]	5
Connector	SMA plug
Operating Temp. [$^{\circ}$ C]	-40 to +80

Table 30: 2600130016 - antenna specifications

Further information and datasheet of the this antenna can be found on our website [5].

7.3.1.2 7488920157 - GNSS multilayer chip antenna



Figure 18: GNSS multilayer chip antenna

Specification	Value
Frequency range [MHz]	1550 MHz - 1600 MHz
Impedance [Ω]	50
VSWR	≤ 2
Peak Gain [dBi]	3.4 (typ.)
Dimensions (L x W) [mm]	5.2 x 3.7
Operating Temp. [$^{\circ}\text{C}$]	-40 to +85

Table 31: 7488920157 - antenna specifications

Further information and datasheet of the this antenna can be found on our website [4].

8 Reference design

Elara-II was tested and certified on the corresponding Elara-II evaluation board, which serves as reference design. For the compliance with the EU directive 2014/53/EU Annex I, the evaluation board serves as reference design.

This is no discrepancy due to the fact that the evaluation board itself does not fall within the scope of the EU directive 2014/53/EU Annex I as the module is tested on the evaluation board, which is also the recommended use.

Further information concerning the use of the evaluation board can be found in the manual of the Elara-II evaluation board [3].

8.1 Schematic

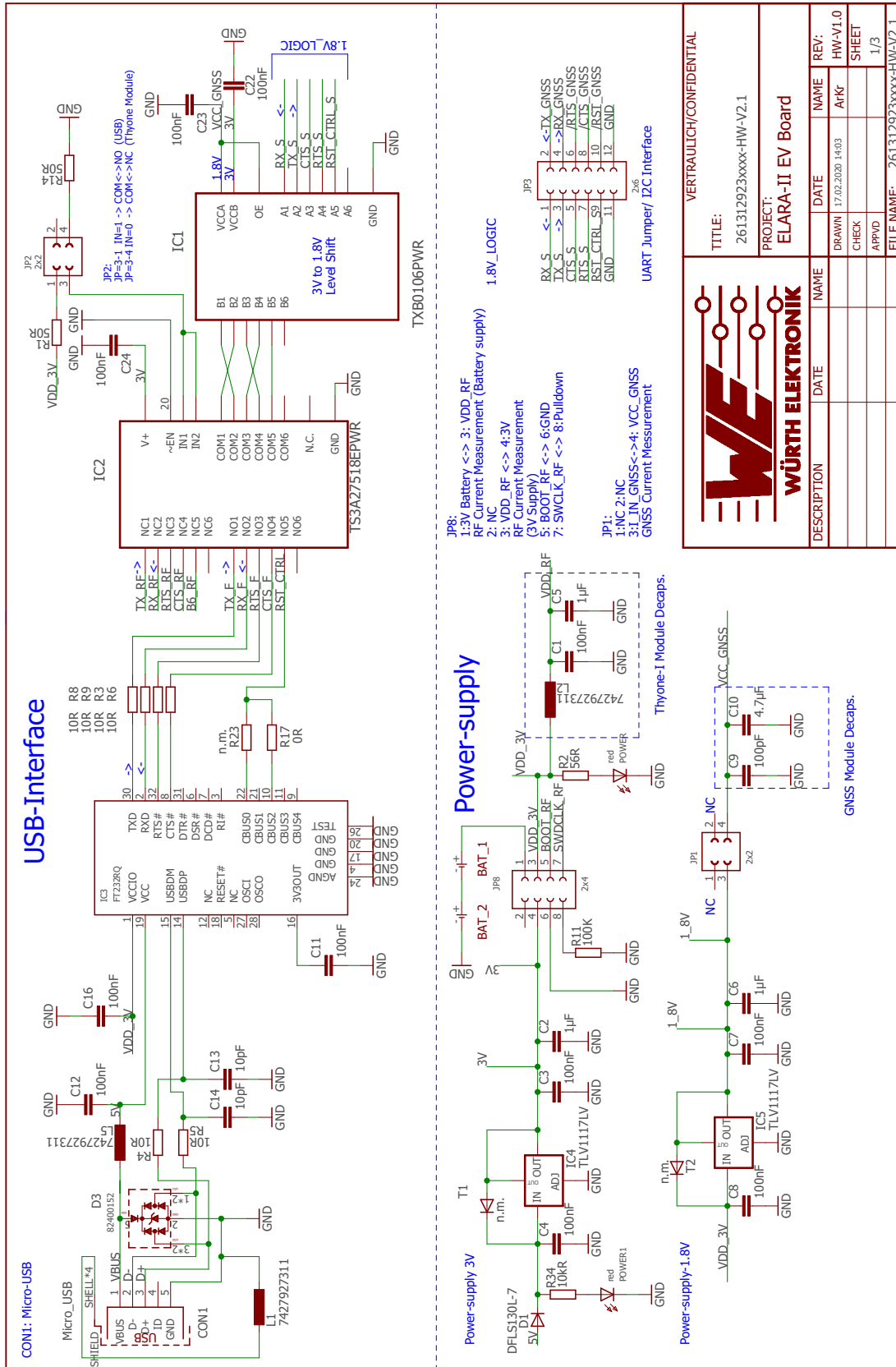

Figure 19: Reference design: Schematic sheet-1

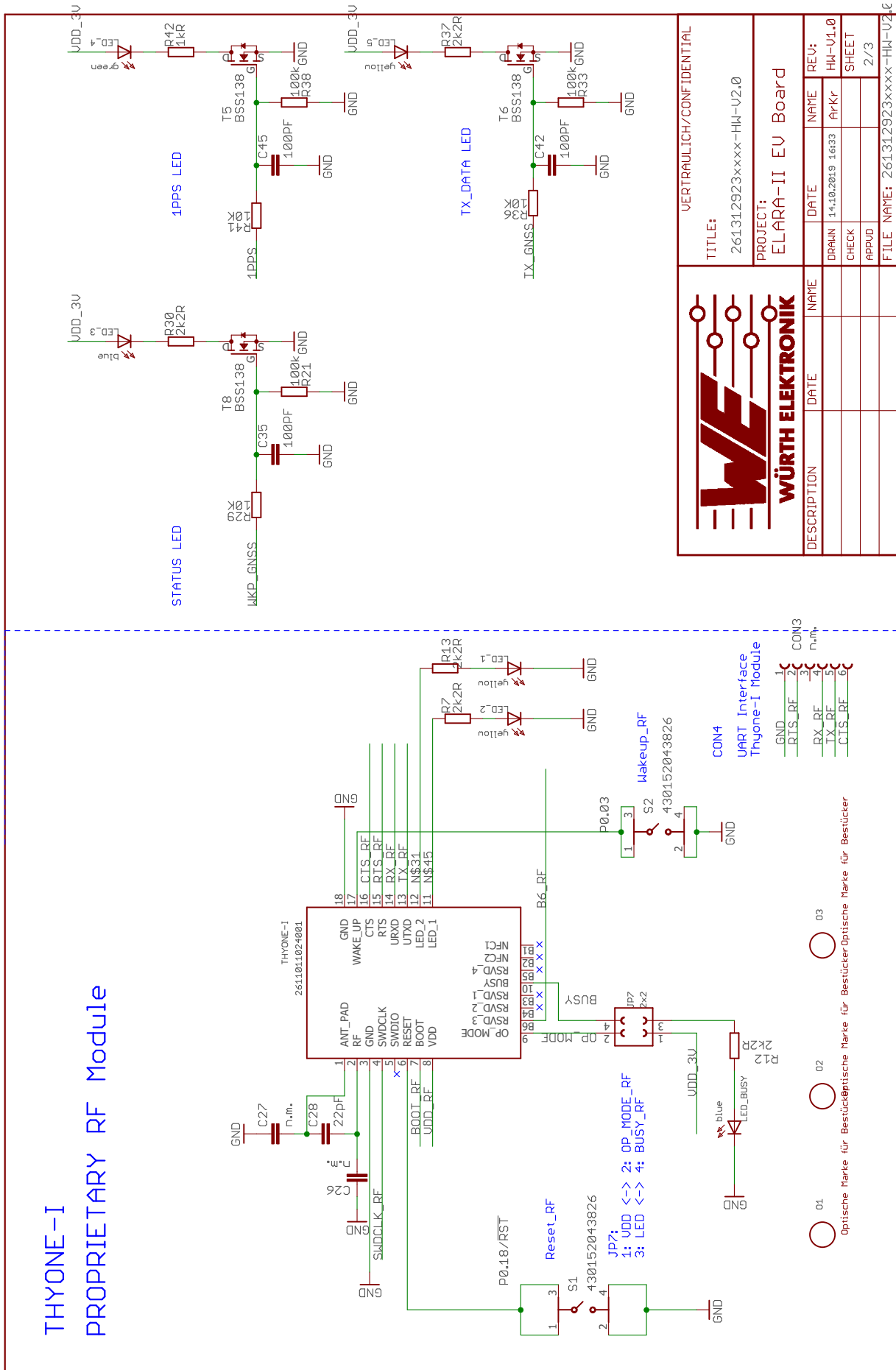

Figure 20: Reference design: Schematic sheet-2

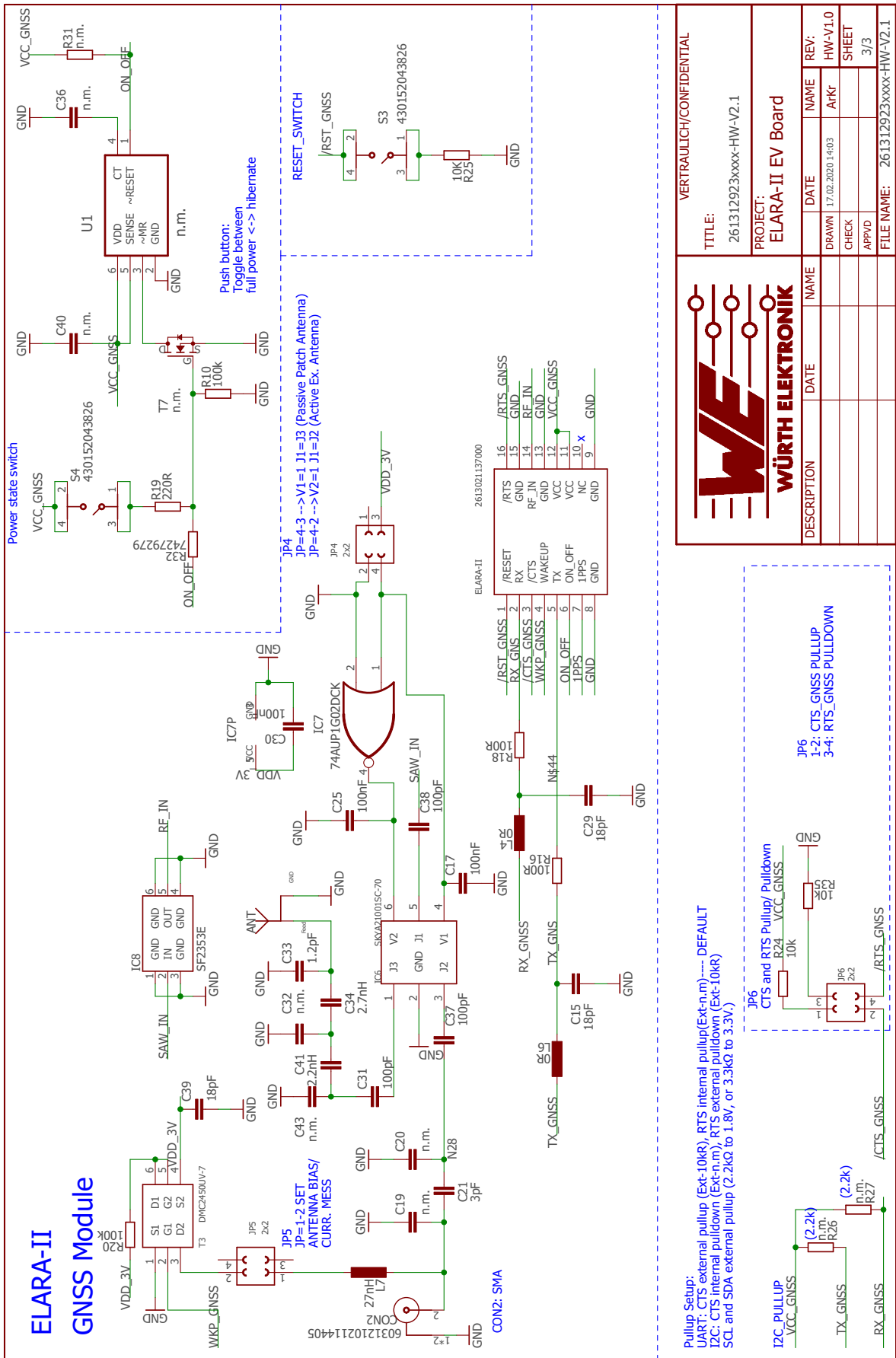

Figure 21: Reference design: Schematic sheet-3

8.2 Layout

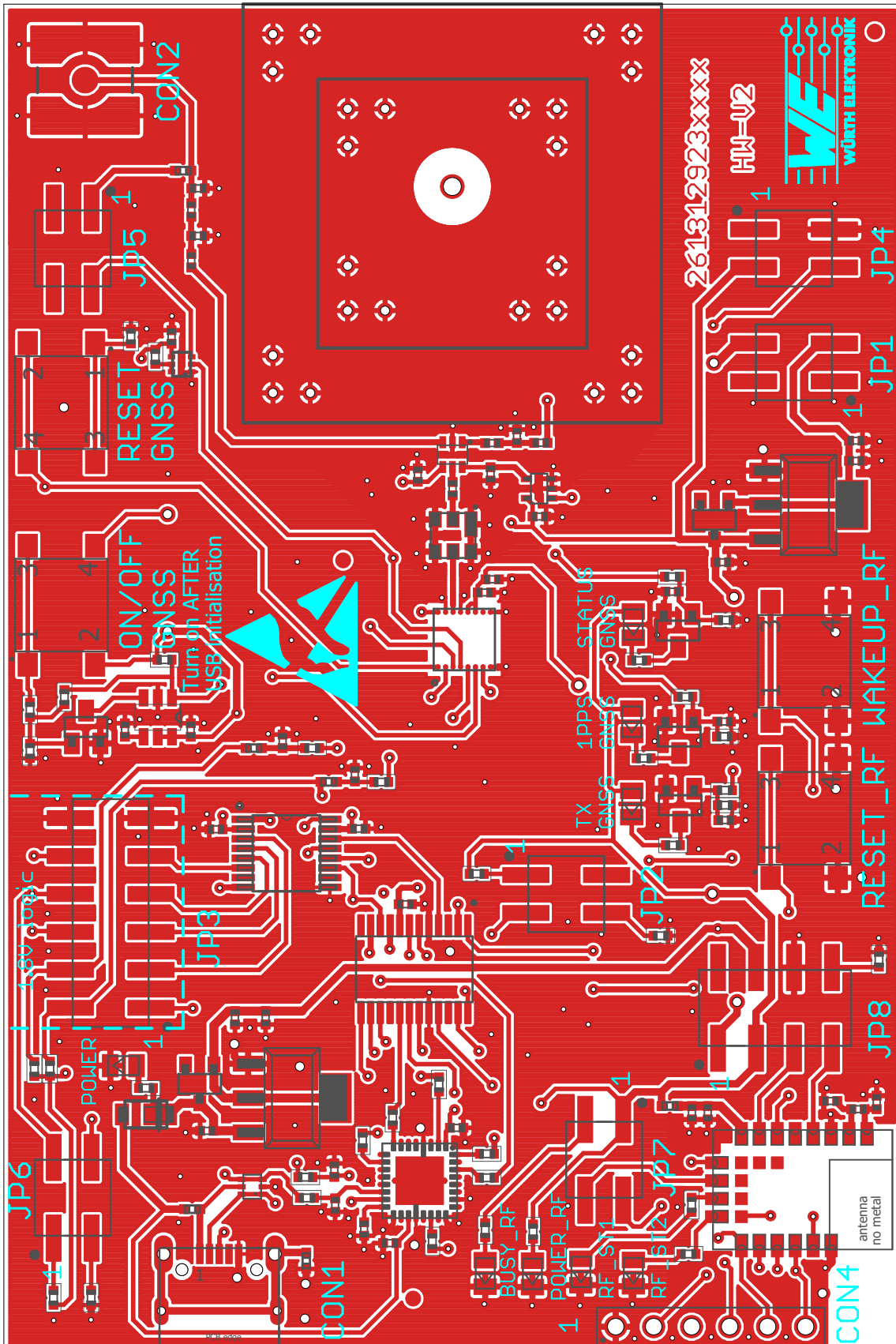

Figure 22: Reference design: Layout

8.3 Interface Selection for SPI

Figure 23 shows the hardware setup for SPI communication.

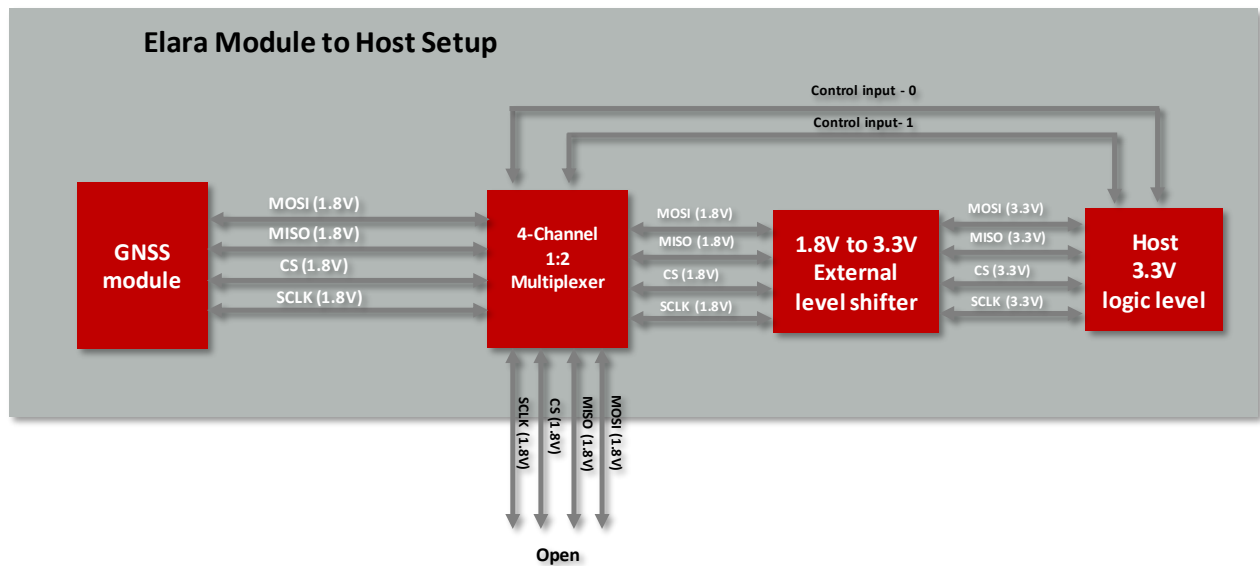

Figure 23: Interface Selection for SPI



During module power up the SPI pins shall be switched open through the multiplexer. Please ensure that the multiplexer does not have internal pull resistors on the input/output lines.

Please refer to Chapter 9.3 for more details about the use of this interface with the Elara-II.

9 Host connection

Elara-II is intended to be used as GNSS module in a system, interfaced with a host microcontroller. Connection to host is possible via UART, I²C or SPI interfaces on the same set of pads. */CTS* and */RTS* lines are used by the module to recognize the interface at module power up. UART is implemented in Elara-II evaluation board as reference design.

Interface	<i>/CTS</i>	<i>/RTS</i>
UART	External pull-up	Open
I ² C	Open	External pull-down
SPI	Open	Open

Table 32: Interface selection

- external resistor of 10kΩ is recommended
- pull-up resistor is referenced to 1.8V

9.1 UART

Elara-II implements the standard UART interface with following properties.

Item	Property
TX line	Output logic high voltage level: 1.8V compatible
RX line	Input logic high voltage level: min 1.45V, max 3.6V
Flow control	Default: disabled
Baud rate (default)	4800 baud

Table 33: UART properties

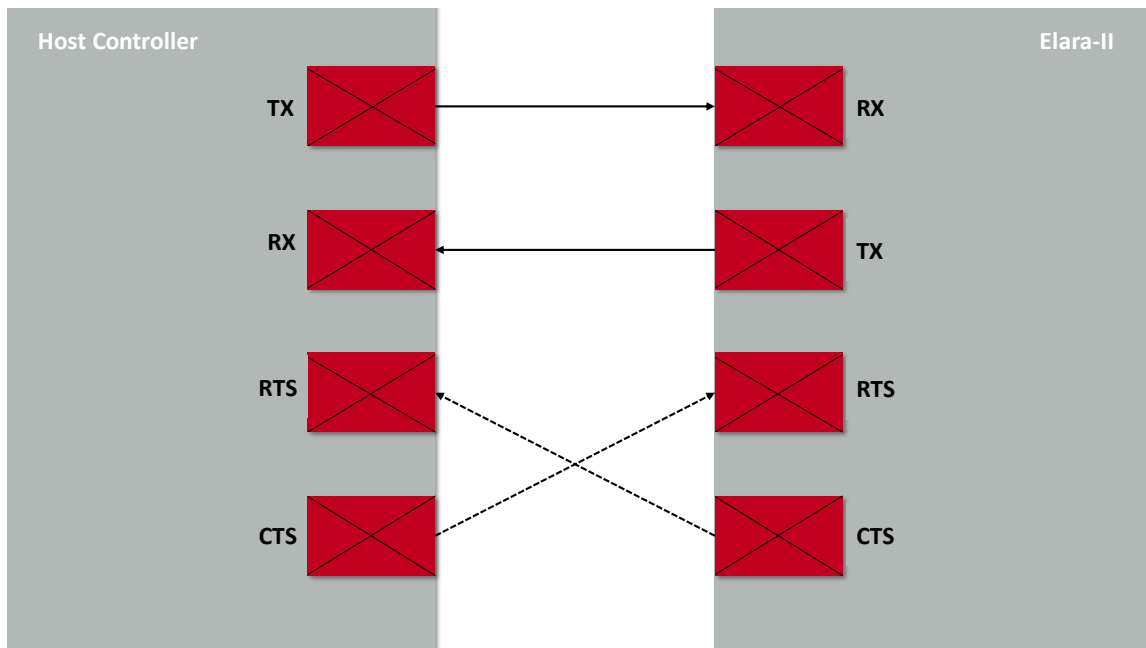

Figure 24: UART host interface

9.2 I²C multi master

Elara-II supports standard I²C (Inter-IC) bus interface as an alternative to the UART interface.

I²C is a serial 8-bit protocol with two-wire interface, which supports communication between different ICs. For example between the μ C and other peripheral devices such as a GNSS module or sensors.

9.2.1 General characteristics

The GNSS module supports the role of I²C multi-master which means it will act as a I²C master and send data to a specific slave address whenever it has data available and the bus is idle. In case the GNSS module has no data to send, it will switch into the I²C slave role to be able to receive data from another master that addresses the GNSS module via the bus.

Item	Property
I ² C mode	Multi Master
I ² C clock (GNSS role = master)	400 kHz (fast mode)
I ² C clock (GNSS role = slave)	up to 400 kHz (normal mode, fast mode)
Supported addressing type	7-bit addressing
Elara-II RX	address 0x60
Elara-II TX	address 0x62
FIFO length	64 bytes
SCL, SDA	pseudo open-drain lines, external pull-up resistors needed: 2.2k Ω to 1.8V

Table 34: I²C properties

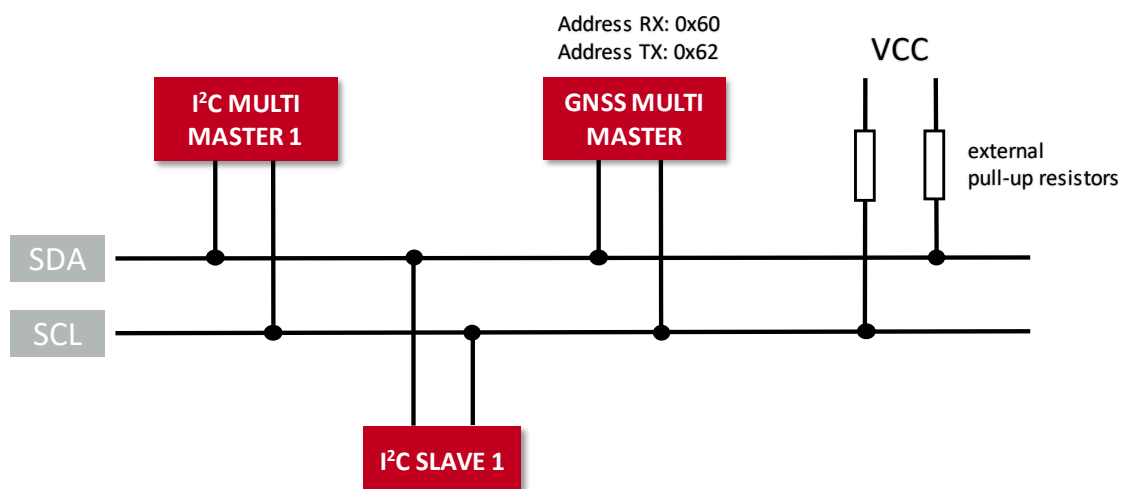

Figure 25: I²C host interface

9.2.2 SDA and SCL logic levels

The Elara-II supports specified logic levels which must be either used by every device on the I²C bus or a logic level conversion must be implemented in-between the GNSS module and the other bus participants. This conversion IC must be selected in a manner that it supports the requirements of I²C set by the GNSS module, i.e. open-drain / open-collector and at least 400kHz clock speed.

9.2.3 Addressing the GNSS module

The GNSS module supports 7-bit addressing. Users must make sure that each device on the I²C bus has a unique address. The master selects the slave by sending a slave address after each START condition.

When the GNSS module takes the role of a master/transmitter it will always try to send data to a fixed 7-bit slave address 1100010b (0x62).

The 7-bit slave/receiving address of the GNSS module is 1100000b (0x60). This address is used by the GNSS module only to receive data from a master.

The R/W bit determines the data direction. A '0' (LOW logic level) indicates a write operation (transmission from master to slave) and a '1' (HIGH) indicates a read operation (data request from slave).

In the master role the GNSS module only uses "write" operation as indicated by the R/W bit in the first byte of a transfer. In the slave role it only supports "write" operations from the master that is sending data to the GNSS module.

The GNSS module does not support I²C messages indicating "read" in the R/W bit.

9.2.4 GNSS communication protocol

The GNSS module uses the NMEA protocol (default) or the OSP binary protocol (optional, can be enabled temporarily by the user). This is valid for any of its host communication interfaces. Details regarding the protocols can be found in 10. The first protocol byte is directly following the 7-bit address and 1 R/W bit.

Users need to ensure that the bus capacity is adequate for the bus data transfer load peaks and that resulting latencies are not detrimental to system performance. This means that only a limited number of participants can be part of the shared bus.

Depending on the enabled messages, the GNSS module will send more or less data to the slave that is addressed by the 0x62 address.

9.2.5 I²C timing parameters

The clock is fixed to 400 kHz during master operation of the module and sending data (fast mode). During slave mode (receiving data from a master) fast mode (400kHz) as well as normal mode (100kHz) are supported by the GNSS module. The bus contention/arbitration

timeout is 30 ms and cannot be changed.

Old data in the GNSS module buffer is discarded when a slave is not acknowledging the reception of the messages from the GNSS module. For optimal operation, the GNSS module assumes unrestricted outflow of serial messages and no periodic inflow of serial messages into the GNSS module.

When a message is sent to the GNSS module the reaction to this message may be delayed until all pending messages in the buffer are sent by the GNSS module and acknowledged by a slave.

9.2.6 I²C communication between Elara-II and a generic Microcontroller

Figure 26 shows the principle that needs to be implemented into the μ C firmware to allow a communication with the GNSS module over the I²C interface and the protocol used in the GNSS module.

The protocol used by the GNSS module is typically different to common sensor protocols. Therewith many existing drivers or hardware abstraction layers are not matching the requirements of the GNSS protocol. It may be necessary to modify existing drivers or write new drivers.

A μ C host driver for use with the GNSS module is required to support at least 400kHz clock, slave mode, 7-bit addressing with the own address 0x62 and a variable I²C transfer length.

The application in the host is also required to support concatenating and parsing NMEA messages that will be sent by the GNSS module.

This scheme assumes that the GNSS module was started into I²C mode and has been woken up from hibernate mode.

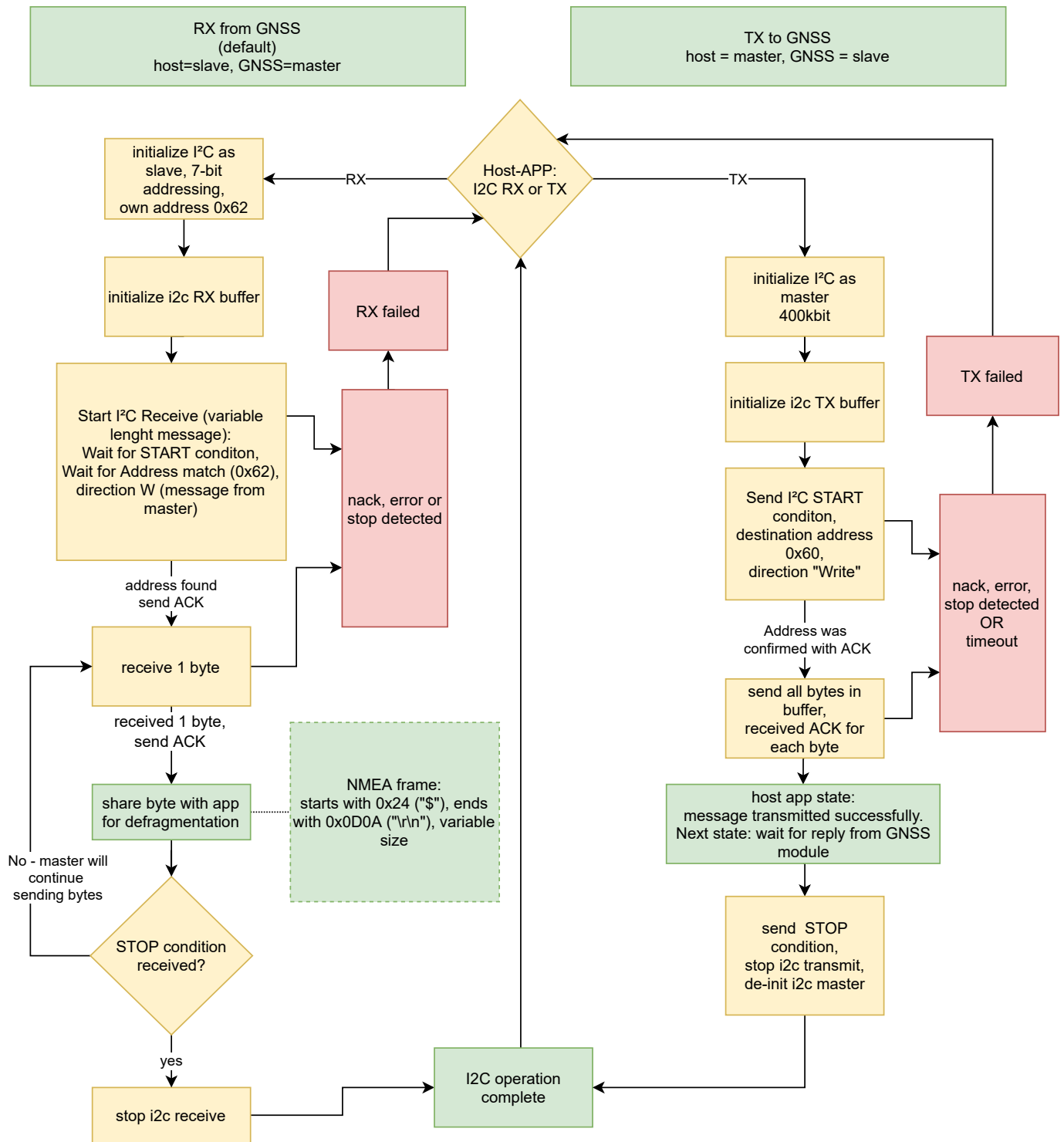

Figure 26: Flowchart for host implementation

For further information about I²C communication with the Elara-II, including description of the hardware setup and taking into operation, please refer to our dedicated application note [2].

9.3 SPI Slave

Elara-II supports standard SPI (Serial Peripheral Interface) bus interface as an alternative to the UART interface. The Elara-II will take the role of a SPI Slave.

SPI, as used by the GNSS module, is a serial 8-bit protocol with 4-wire interface, which supports communication between different ICs. It operates in full duplex mode, which means Master and Slave can send data at the same time to each other. For example between the μC and other peripheral devices such as a GNSS module or sensors.

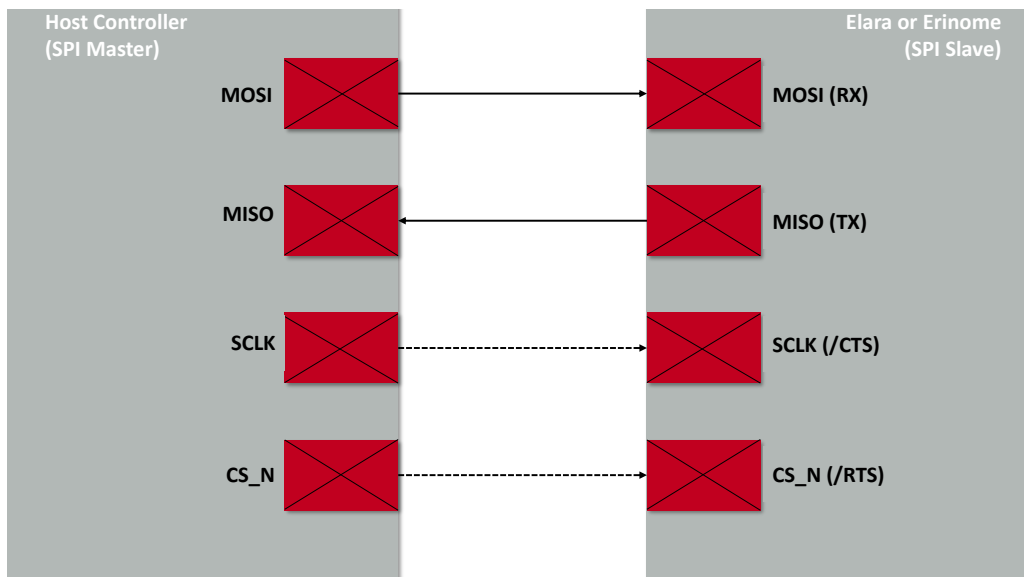

Figure 27: SPI interface

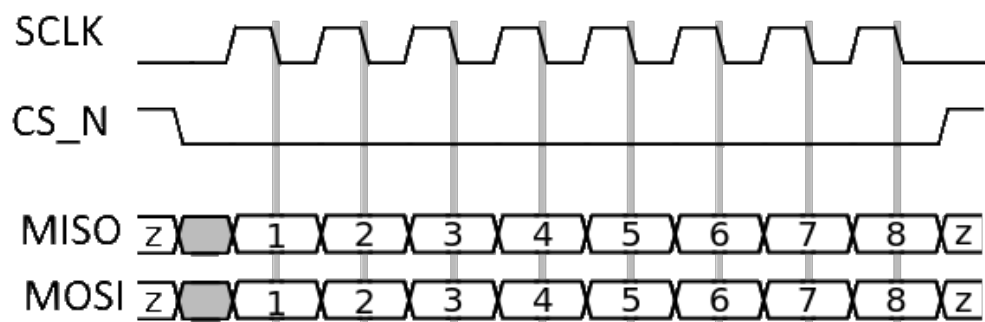

Figure 28: SPI Mode 1 (CPHA=1, CPOL=0)

9.3.1 General characteristics

The GNSS module supports the role of SPI Slave. That means a SPI Master needs to be connected to the GNSS module and readout the FIFO content of the GNSS module whenever data is available. This process is called polling. The SPI Master needs to select the SPI Slave device by signaling CS_N (chip select) LOW towards the Slave. The SPI Master has to provide the clock signal for the bit sampling.

In case the FIFO of the GNSS module is empty, it will indicate that by sending GNSS FIFO idle bytes. this means the Master may stop the current transmission by ending the pending byte and signaling CS_N HIGH. A later transmission session will be signaled by CS_N LOW by the Master again.

Any traffic on the SPI data lines goes directly into or comes out from the respective rx or tx FIFO of the two devices. There is no additional register mapping or addressing in case of SPI communication with the Elara-II.

Item	Property
SPI role	Slave
SPI clock, max	6.8 MHz
SPI Mode	Mode 1 (CPHA=1, CPOL=0)
GNSS FIFO size	1024 Byte
GNSS FIFO idle bytes	0xA7B4
SPI Master idle bytes	0xFFFF
SPI MOSI, SCLK, CS_N	input for GNSS
SPI MISO	output for GNSS
SPI bit order	MSB first (most significant bit first)

Table 35: SPI properties of GNSS module

9.3.2 Addressing the GNSS module

The GNSS module is addressed by a LOW signal on the CS_N line. Any byte received is directly handed over to the receive FIFO and vice versa.

9.3.3 SPI timing parameters

The maximum clock speed supported by the Elara-II is 6.8 MHz. Depending on the user's hardware layout, the SPI clock must be adopted (i.e. be reduced) to ensure clean edges of the level changes. This is very important, since the change of the edges is used for sampling data.

9.3.4 GNSS communication protocol

The GNSS module uses the NMEA protocol (default) or the OSP binary protocol (optional, can be enabled temporarily by the user). This is valid for any of its host communication interfaces. Details regarding the protocols can be found in Chapter 10.

Users need to ensure that the bus capacity is adequate for the bus data transfer load peaks and that resulting latencies are not detrimental to system performance. The SPI Master is required to poll any available data from the GNSS module to prevent malfunction and data loss.

Depending on the enabled messages, a different amount of data will be available in the Slave's FIFO buffer per time interval. Any data in the GNSS module FIFO has to be read ("polled") by the SPI Master.

9.3.5 SPI communication between Elara-II and a generic Microcontroller

The following figures show the principle that needs to be implemented into the μ C firmware to allow a communication with the GNSS module over the SPI interface.

The SPI protocol used by the GNSS module is different to common sensor protocols. There-with many existing drivers or hardware abstraction layers are not matching the requirements of the GNSS module SPI communication handling. It may be necessary to modify existing drivers or write new drivers for the SPI Master in the host.

A μ C host driver for use with the Elara-II is required to support:

- SPI Master role
- SPI Mode 1 (CPHA=1, CPOL=0)
- handling of variable SPI transfer lengths
- receiving of at least 1024 byte in one SPI transfer
- configuring the GNSS module interface select lines (/RTS and /CTS) in the state "open" while GNSS boot-up
- configuring the GNSS module interface select lines (/RTS and /CTS) for SPI Clock and Chip Select (CS_N) during the normal operation

The application in the host is required to support concatenating and parsing NMEA messages that will be sent by the GNSS module. The OSP protocol must be implemented when the end-application is required to use it.

The following schemes assume that the GNSS module was started properly into SPI Slave mode and has been woken up from hibernate mode.

The host has no possibility to check if the SPI boot-up was proper until communication with the module can or cannot be established by performing the "READ process" shown below.

After a re-boot the first message from the GNSS module will be the "OK_TO_SEND" message (\$PSRF150,1*3E followed by one byte carriage return 0x0D and one byte line feed 0x0A).

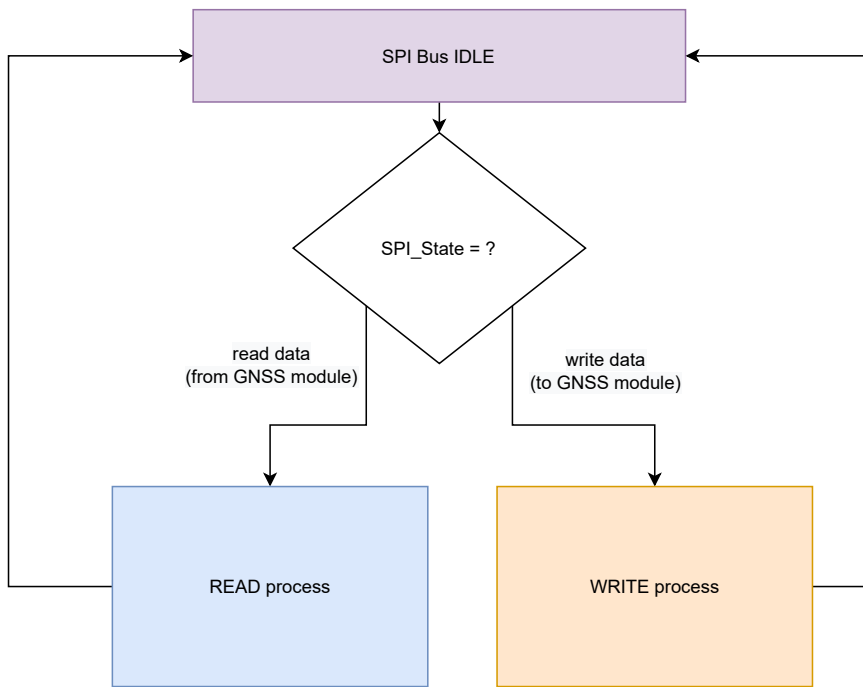

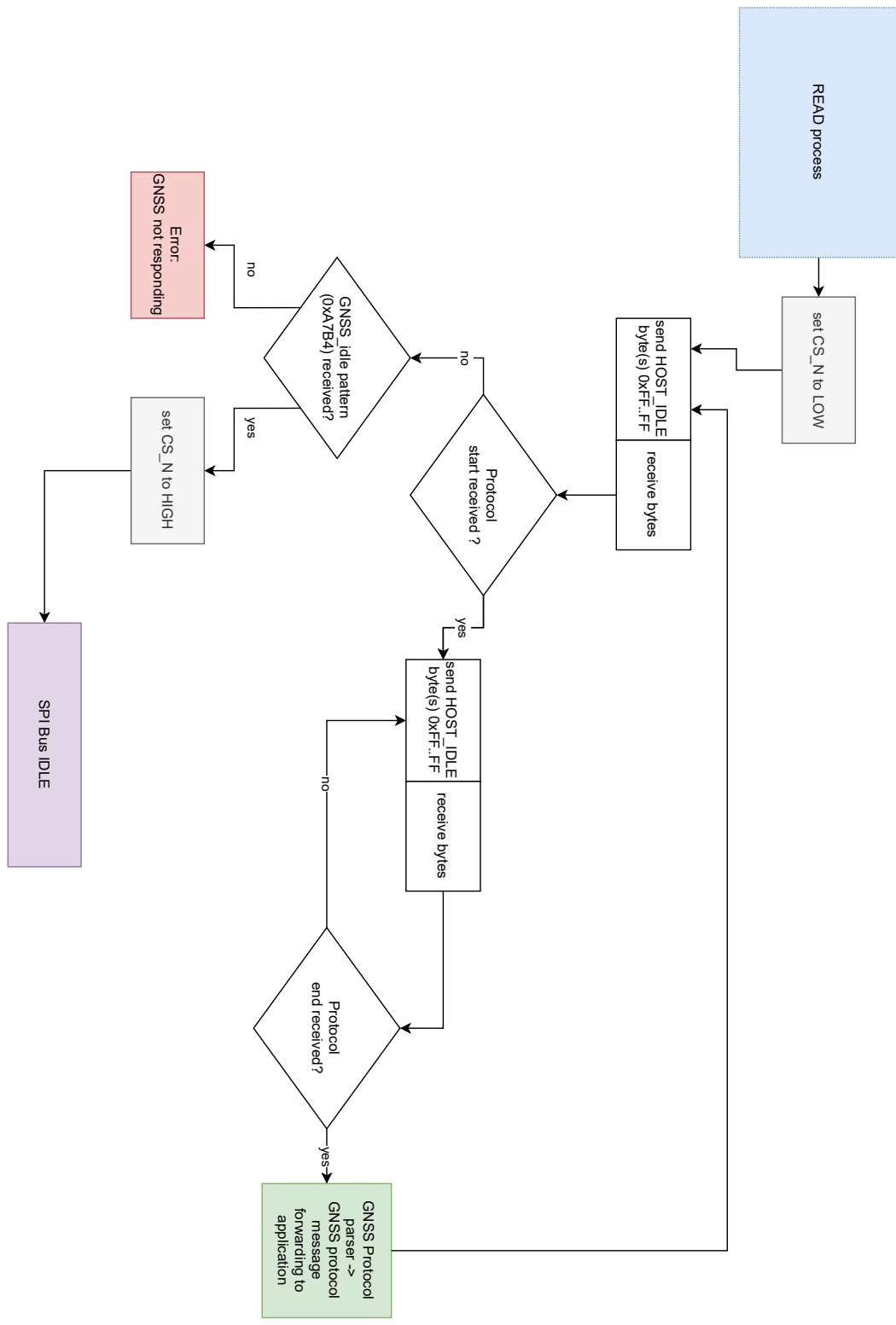

Figure 29: Flowchart Read for SPI Master implementation

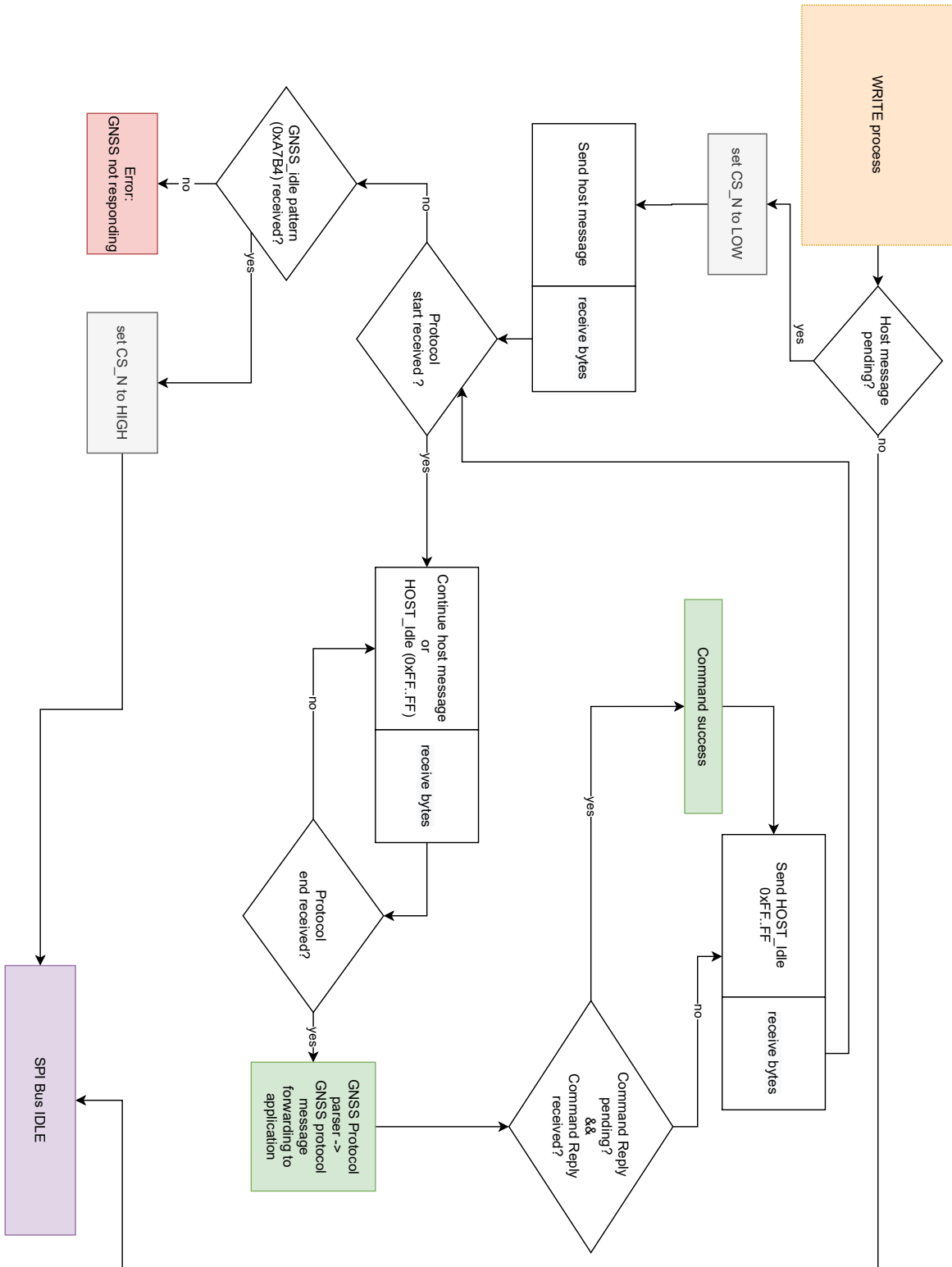

Figure 30: Flowchart Write for SPI Master implementation

10 Elara-II communication protocols

The Elara-II module can communicate with the host through two available protocols: NMEA and OSP. OSP is the Qualcomm proprietary protocol. NMEA protocol foresees standard compliant as well as product-specific sentences.

While NMEA is simpler than OSP, some of the module functions can be activated only via OSP. Both NMEA and OSP protocols include input messages (commands sent from host) and output messages (messages sent from the module to host). Scope of the input commands is changing module configuration settings and modes of operation.

In end applications, relevant information (e.g. position and time) can be extracted from the output messages through parsing of the messages.

This chapter contains the description of a selection of NMEA and OSP messages and commands which are relevant for module's operation. This chapter will be revised with additional information in future manual revisions.

Our proprietary PC tool (WENSS) [8], together with the EV-board [9], can be used to understand and test communication with Elara-II. It supports the user in getting familiar with NMEA and OSP protocols. It implements parsing of NMEA and OSP messages, pre-defined commands, and a utility for checksum calculation.

WENSS is using the UART communication interface and does not support SPI or I²C as communication interface.

Communication Protocol	Description
NMEA	- standard sentences (start with Talker ID) - product-specific sentences (start with protocol header \$PSRFMessageNumber)
OSP	product-specific

Table 36: Communication Protocol

10.1 NMEA sentences

NMEA is a protocol originally used for communication between marine electronics and is widely used in GNSS receivers. It is simpler than OSP and widely documented. It is extended with product-specific sentences with a slightly different message structure.

Overall NMEA message structure is represented here below and is the basis for understanding all sentences and commands. NMEA messages are encoded in human readable ASCII characters 0-9, a-z, A-Z, and some special ASCII characters like \$,*. All fields are comma-separated. All messages are completed by the checksum. NMEA messages are sent as ASCII data.

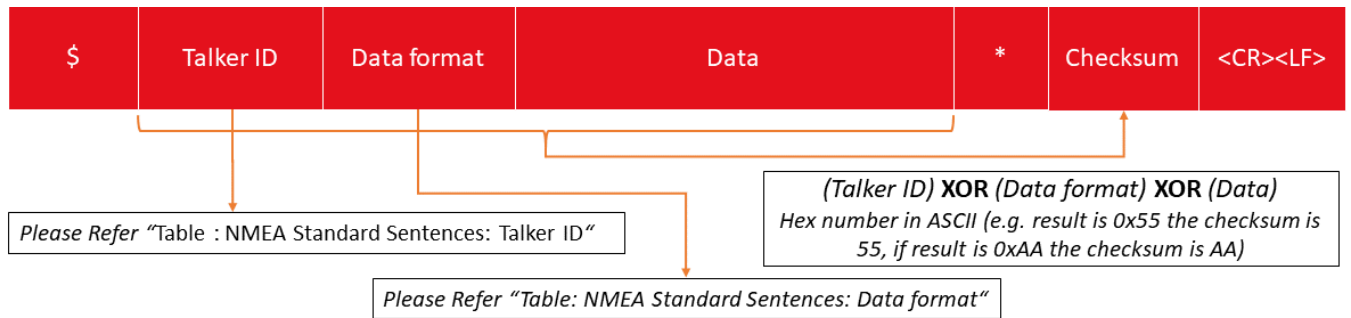

Figure 31: NMEA Standard Sentences for Elara-II

Field	Description
GP	GPS satellites
GL	GLONASS satellites
GN	Satellites from multiple constellations

Table 37: NMEA Standard Sentences: Talker ID

Field	Description
GGA	Time, position and fix type data for GPS constellations
GLL	Latitude, longitude, UTC time of position fix and status
GNS	Time, position and fix type date for all constellations
GSA	GPS receiver operating mode, satellites used in the position solution and DOP values
GSV	Number of GPS satellites in view, satellite ID numbers, elevation, azimuth and SNR values
RMC	Time, date, position, course and speed data
VTG	Course and speed information relative to the ground
ZDA	PPS timing message, synchronized to PPS

Table 38: NMEA Standard Sentences: Data format

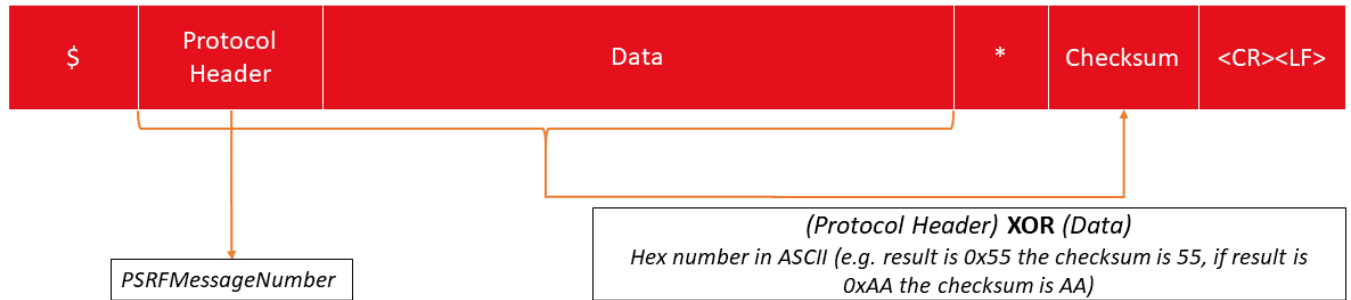

Figure 32: NMEA Product-Specific Sentences for SiRFStar V

For standard compliant sentences, checksum is calculated with the following formula, where conversion to HEX is needed before XOR operation.

Talker ID XOR Data format XOR Data

Example sentence:

`$GNZDA,204519.000,25,12,2019,,*4D`

In this example, checksum 4D is obtained as following:

- $\text{HEX}(G) \text{ XOR } \text{HEX}(N) \text{ XOR } \text{HEX}(Z) \text{ XOR } \text{HEX}(D) \text{ XOR } \text{HEX}(A) \text{ XOR } \text{HEX}(,) \text{ XOR } \text{HEX}(2) \text{ XOR } \dots \text{ XOR } (,) = 0x4D_{\text{hex}}$
- $\text{ASCII}[0x4D_{\text{hex}}] = 4D$

For non-compliant sentences, checksum is calculated with the following formula:

Protocol Header XOR Data

Example:

`$PSRF100,0,115200,8,1,0,*04`

In this command, checksum 04 is obtained as following:

Checksum = Protocol Header XOR Data =

$\text{ASCII}[\text{HEX}(P) \text{ XOR } \text{HEX}(S) \text{ XOR } \text{HEX}(R) \text{ XOR } \dots \text{ XOR } \text{HEX}(,)] = 04$

10.1.1 NMEA sentences overview

Data Format	Input/Output	Short description	Link to description
GGA	Output	Time, position, and fix type data	GGA
GLL	Output	Latitude, longitude, time, and status	GLL
GNS	Output	Time, position, and fix type data	GNS
GSA	Output	GNSS receiver operating mode, satellites used in the position solution and DOP values	GSA
GSV	Output	Number of GPS satellites in view, satellite ID numbers, elevation, azimuth and SNR values	GSV
RMC	Output	Time, date, position, course and speed data	RMC
VTG	Output	Course and speed information relative to the ground	VTG
ZDA	Output	Timing message, synchronized to PPS pulse	ZDA
PSRFEPE	Output	Navigation data	PSRFEPE
PSRF150	Output	Module status. Indicates if host can communicate with the module	PSRF150
PSRF195	Output	Software version. Response to PSRF125	PSRF195
PSRF103	Input	Change message rate	PSRF103
PSRF100	Input	Switch protocol and baud rate	PSRF100
PSRF125	Input	Poll software version	PSRF125
PSRF101	Input	Restart the module	PSRF101

Table 39: Message overview

10.1.2 NMEA output sentences

Most relevant NMEA output messages are the ones containing position, time and related information about the position fix. If the module is in full power mode, these are sent automatically with the configured update rate. Other NMEA output messages are product specific and sent from the module in response to specific commands or events.

Most relevant NMEA output message types and corresponding data fields are described in the following pictures and table.

- **GGA Data Format:**

Field	Description
UTC Time	hhmmss.sss (Hours Minutes Seconds)
Latitude	ddmm.mmmm (Degree Minutes)
N/S	N: North S: South
Longitude	Ddmm.mmmm (Degree Minutes)
E/W	E: East W: West
Position Fix Indicator	0: Fix not available or invalid 1: Fix valid
Satellites used	In fix: 0-12
HDOP	Horizontal Dilution of Precision
MSL Altitude	In meters
Units	M (meters)
Geoid Separation	Geoid-to-ellipsoid separation Ellipsoid altitude = Geoid MSL altitude + Geoid separation
Units	M (meters)
Empty field	Empty field
Null field	0000

Table 40: GGA Data Format

An example of GGA sentence is:

```
$GPGGA,153219.000,4809.0013,N,01135.0012,E,1,08,0.8,457.7,M,47.6,M,,0000*57
```

- **GLL Data Format:**

Field	Description
Latitude	Ddmm.mmmm (Degree Minutes)
N/S	N: North S: South
Longitude	Ddmmmmmm (Degree Minutes)
E/W	E: East W: West
UTC Time	Hhmmss.sss (Hours Minutes Seconds)
Status	A: Data Valid V: Data not Valid
Mode	A: Autonomous N: Output Data Not Valid R: Coarse Position (SV states based on almanac, not ephemeris)

Table 41: GLL Data Format

Talker ID for this message is GP only.

An example of GLL sentence is:

```
$GNGLL,4809.0009,N,01135.0008,E,153450.000,A,A*43
```

- **GNS Data Format:**

Field	Description
UTC of position	hhmmss.sss (Hours Minutes Seconds)
Latitude	ddmm.mmmm (Degree Minutes)
N/S	N: North S: South
Longitude	ddmm.mmmm (Degree Minutes)
E/W	E: East W: West
Mode Indicator	A: Autonomous (satellite system used in standard mode) E: Estimated M: Manual Input N: No fix Variable length, max. 2 characters, order: GPS-GLO
Satellites used	In fix: 0-99
HDOP	Horizontal Dilution of Precision
MSL Altitude	In meters
Geoid Separation	Geoid-to-ellipsoid separation Ellipsoid altitude = Geoid MSL altitude + Geoid separation
Empty field	Empty field
Null field	0000

Table 42: GNS Data Format

An example of GNS sentence is:

```
$GNGNS,152715.000,4809.0010,N,01134.9989,E,AA,08,1.2,467.7,47.6,,0000*63
```

- **GSA Data Format:**

Field	Description
Mode 1	A: Automatic. Enabled to automatically switch 2D/3D
Mode 2	1: Fix not available 2: 2D (<4 SVs used) 3: 3D (>4 SVs used)
Satellite used [1...12]	1 to 32: GPS (PRN code) 33 to 51: SBAS (PRN-87) 52 to 61: QZSS 65 to 96: GLONASS (Slot#+64)
PDOP	Position Dilution of Precision
HDOP	Horizontal Dilution of Precision
VDOP	Vertical Dilution of Precision

Table 43: GSA Data Format

An example of GSA sentence is:

```
$GNGSA,A,3,06,21,29,19,18,31,27,05,,,,,1.5,0.8,1.2*2E
```

- **GSV Data Format:**

Field	Description
Number of Messages	Total number of GSV messages to be sent in this group
Message Number	Message number in this group of GSV messages
Satellites in View	Number of satellites in view
Satellite ID	1 to 32: GPS (PRN code) 33 to 51: SBAS (PRN-87) 52 to 61: QZSS 65 to 96: GLONASS (Slot#+64)
Elevation angle	0 to 90 degrees
Azimuth angle	0 to 359 degrees clockwise from North
C/N ₀	Carrier-to-Noise density: 0 to 99 dB-Hz, null when not tracking
...	Satellite ID, elevation, azimuth and C/N ₀ are repeated for three additional satellites

Table 44: GSV Data Format

An example of GSV sentence is:

```
$GPGSV,3,1,10,21,54,218,40,06,40,286,40,19,35,279,40,29,54,079,40*7B
$GPGSV,3,2,10,18,33,135,40,31,29,251,40,05,35,074,40,27,32,283,40*75
$GPGSV,3,3,10,57,17,303,,07,04,337,,*78
```

- **RMC Data Format:**

Field	Description
UTC Time	hhmmss.sss (Hours Minutes Seconds)
Status	A: Data Valid V: Data not Valid
Latitude	ddmm.mmmm (Degree Minutes)
N/S	N: North S: South
Longitude	ddmm.mmmm (Degree Minutes)
E/W	E: East W: West
Speed Over Ground	in Knots
Course Over Ground	in Degrees
Date	ddmmyy (Day Month Year)
Empty field	Empty field
Empty field	Empty field
Mode	A: Autonomous (standard) N: Output Data Not Valid R: Coarse Position (SV states based on almanac, not ephemeris)

Table 45: RMC Data Format

An example of RMC sentence is:

```
$GNRMC,155401.000,A,4809.0000,N,01135.0002,E,0.00,0.00,251219,,A*79
```

- **VTG Data Format:**

Field	Description
Course	Measured heading (degrees)
Reference	True
Empty field	Empty field
Reference	Magnetic
Speed	Measured horizontal speed (knots)
Units	In knots
Speed	Measured horizontal speed (km/h)
Units	In km/hour
Mode	A: Autonomous N: Output Data Not Valid R: Coarse Position (SV states based on almanac, not ephemeris)

Table 46: VTG Data Format

An example of VTG sentence is:

```
$GNVTG,0.00,T,M,0.00,N,0.0,K,A*13
```

- **ZDA Data Format:**

Field	Description
UTC Time	hhmmss.sss (Hours Minutes Seconds)
Day	Day of the month (range 1 to 31)
Month	Month of the year (range 1 to 12)
Year	Year
Empty field	Empty field
Empty field	Empty field

Table 47: ZDA Data Format

An example of ZDA sentence is:

\$GNZDA,163101.000,25,12,2019,,*42

- **\$PSRFEPE:** If activated through command \$PSRF103, \$PSRFEPE is sent from the receiver together with standard output messages with the configured rate.

Field	Description
\$PSRFEPE	Protocol header
UTC	Hhmmss.sss (Hours Minutes Seconds)
HDOP	Horizontal Dilution Of Precision
EHPE	Estimated Horizontal Position Error (meters)
EVPE	Estimated Vertical Position Error (meters)
EHVE	Estimated Velocity Error (m/s)
EHE	Estimated Heading Error (degrees)

Table 48: Estimated Position Error

An example of EPE sentence is:

```
$PSRFEPE,163910.000,A,0.6,2.65,2.56,0.0,180.0*19
```

- **\$PSRF150:** \$PSRF150 is sent from the receiver to indicate status and if communication with host is possible.

Field	Description
\$PSRF150	Protocol header
OkToSend	0: CPU is about to go Off and stay in Hibernate. 1: CPU has just come On in Full Power Mode.

Table 49: Ok To Send

This sentence is sent as last message when transiting from full power to hibernate state (not ok to send) and as first message when transiting from hibernate state to full power (ok to send)

The two possible versions of this sentence are:

```
$PSRF150,0*3F
```

```
$PSRF150,1*3E
```

- **\$PSRF195**: \$PSRF195 is sent from the receiver in response to the "poll SW version" command (\$PSRF125).

Field	Description
\$PSRF195	Protocol header
Version String	SW version string

Table 50: Response to Poll SW version

An example of this sentence is:

\$PSRF195,5xp__5.5.2-R32+5xpt_5.5.2-R32*06

10.1.3 NMEA input sentences

Most relevant NMEA input message types and corresponding data fields are described in the following pictures and table. All NMEA input messages are manufacturer or even IC specific.

- **\$PSRF103:**

NMEA command \$PSRF103 allows selecting which NMEA output message types are sent out from the module and at which rate. 5 Hz update rate (5 messages/second) supports applications where a finer grid of navigation points is needed (ex. high speed). If enabled, 5 Hz update rate applies to all standard compliant NMEA output messages, unless deactivated.

Field	Description
\$PSRF103	Protocol header
Message to control	0: GGA / Update rate > 1 Hz 1: GLL 2: GSA 3: GSV 4: RMC 5: VTG 7: EPE 8: ZDA 9: GNS
Action	0: set rate 1: query one time 6: activate 5 Hz update rate 7: deactivate 5 Hz update rate
Rate	0: deactivate message / Update Rate > 1Hz 1-255: seconds between messages
En. Checksum	1: checksum enabled (do not change)

Table 51: Message rate selection

If overflow causes delay in delivering the NMEA messages, this message can be used to reduce the number of messages sent from the module in the time unit.

Example: change rate of output message GLL to 5 seconds.

```
$PSRF103,1,0,5,1*3D
```

Example: enable 5 Hz navigation.

```
$PSRF103,0,6,0,1*22
```

Example: query GSV message once.

\$PSRF103,3,1,0,1*26



When 5 Hz navigation is active, baud rate has to be increased in order to support the higher data flow

The different update rates (1 msg/sec, 5 msg/sec) can be observed along the time stamps of the single messages. See an example from WENSS PC tool here below.

```
[06:40:40.119] $GNGNS,195648.000,4808.9996,N,01135.0004,E,AA,18.0,6.462.8,47.6,,0000*64
[06:40:41.120] $GNGNS,195649.000,4808.9996,N,01135.0004,E,AA,18.0,6.462.8,47.6,,0000*65
[06:40:42.104] $GNGNS,195650.000,4808.9996,N,01135.0004,E,AA,18.0,6.462.8,47.6,,0000*6D
[06:40:43.104] $GNGNS,195651.000,4808.9996,N,01135.0004,E,AA,18.0,6.462.8,47.6,,0000*6C
[06:40:44.120] $GNGNS,195652.000,4808.9996,N,01135.0004,E,AA,18.0,6.462.8,47.6,,0000*6F
[06:40:45.104] $GNGNS,195653.000,4808.9996,N,01135.0004,E,AA,18.0,6.462.8,47.6,,0000*6E
[06:40:46.104] $GNGNS,195654.000,4808.9996,N,01135.0004,E,AA,18.0,6.462.8,47.6,,0000*69
[06:40:47.105] $GNGNS,195655.000,4808.9996,N,01135.0004,E,AA,18.0,6.462.8,47.6,,0000*68
[06:40:48.136] $GNGNS,195656.000,4808.9996,N,01135.0004,E,AA,18.0,6.462.8,47.6,,0000*6B
[06:40:49.105] $GNGNS,195657.000,4808.9996,N,01135.0004,E,AA,18.0,6.462.8,47.6,,0000*6A
[06:40:50.089] $GNGNS,195658.000,4808.9996,N,01135.0004,E,AA,18.0,6.462.8,47.6,,0000*65
[06:40:51.152] $GNGNS,195659.000,4808.9996,N,01135.0004,E,AA,18.0,6.462.8,47.6,,0000*64
[06:40:52.074] $GNGNS,195700.000,4808.9996,N,01135.0004,E,AA,18.0,6.462.8,47.6,,0000*69
[06:40:53.043] $GNGNS,195701.000,4808.9996,N,01135.0004,E,AA,18.0,6.462.8,47.6,,0000*68
```

Figure 33: Example of 1 Hz navigation

```
[06:44:03.062] $GNGNS,200011.000,4808.9996,N,01135.0004,E,AA,18.0,6.462.8,47.6,,0000*61
[06:44:03.249] $GNGNS,200011.200,4808.9996,N,01135.0004,E,AA,18.0,6.462.8,47.6,,0000*63
[06:44:03.436] $GNGNS,200011.400,4808.9996,N,01135.0004,E,AA,18.0,6.462.8,47.6,,0000*65
[06:44:03.811] $GNGNS,200011.600,4808.9996,N,01135.0004,E,AA,18.0,6.462.8,47.6,,0000*67
[06:44:03.929] $GNGNS,200011.800,4808.9996,N,01135.0004,E,AA,18.0,6.462.8,47.6,,0000*69
[06:44:04.070] $GNGNS,200012.000,4808.9996,N,01135.0004,E,AA,18.0,6.462.8,47.6,,0000*62
[06:44:04.242] $GNGNS,200012.200,4808.9996,N,01135.0004,E,AA,18.0,6.462.8,47.6,,0000*60
[06:44:04.430] $GNGNS,200012.400,4808.9996,N,01135.0004,E,AA,18.0,6.462.8,47.6,,0000*66
[06:44:04.645] $GNGNS,200012.600,4808.9996,N,01135.0004,E,AA,18.0,6.462.8,47.6,,0000*64
[06:44:04.880] $GNGNS,200012.800,4808.9996,N,01135.0004,E,AA,18.0,6.462.8,47.6,,0000*6A
[06:44:05.067] $GNGNS,200013.000,4808.9996,N,01135.0004,E,AA,18.0,6.462.8,47.6,,0000*63
[06:44:05.255] $GNGNS,200013.200,4808.9996,N,01135.0004,E,AA,18.0,6.462.8,47.6,,0000*61
[06:44:05.442] $GNGNS,200013.400,4808.9996,N,01135.0004,E,AA,18.0,6.462.8,47.6,,0000*67
[06:44:05.629] $GNGNS,200013.600,4808.9996,N,01135.0004,E,AA,18.0,6.462.8,47.6,,0000*65
[06:44:05.817] $GNGNS,200013.800,4808.9996,N,01135.0004,E,AA,18.0,6.462.8,47.6,,0000*6B
[06:44:06.020] $GNGNS,200014.000,4808.9996,N,01135.0004,E,AA,18.0,6.462.8,47.6,,0000*64
```

Figure 34: Example of 5 Hz navigation

- **\$PSRF100:**

NMEA command \$PSRF100 can be used to switch protocol and to select baud rate.

Field	Description
\$PSRF100	Protocol header
Protocol	0: OSP 1: NMEA
Baud rate	4800, 9600, 19200, 38400, 57600, 115200, 230400, 460800, 921600, 12288001
DataBits	8
StopBits	1
Parity	0

Table 52: Baud rate selection

Example: switch to OSP at 115200 bd

```
$PSRF100,0,115200,8,1,0*04
```

Example: switch to NMEA at 921600 bd

```
$PSRF100,1,921600,8,1,0*0E
```

- **\$PSRF125:**

\$PSRF125 allows polling SW version string. The complete command is simply:

```
$PSRF125*21
```

Module responds with NMEA output message \$PSRF195.

Field	Description
\$PSRF195	Protocol header
Version String	SW version string

Table 53: Response to Poll SW version

- **\$PSRF101:**

Hot, warm and cold start can be performed using NMEA command \$PSRF101. Initialization data (position and time) can be injected through the corresponding parameters.

Field	Description
\$PSRF101	Protocol header
ECEF X	X position (ECEF coordinate system, meters)
ECEF Y	Y position (ECEF coordinate system, meters)
ECEF Z	Z position (ECEF coordinate system, meters)
ClkDrift	Clock drift: 0 (Hz) for last saved value
Time Of Week	GPS time of week (seconds)
Week number	GPS week number
Channel count	12
Reset Configuration	1: Hot Start 2: Warm start with no initialization data (fields ECEF X, ECEF Y, ECEF Z) 3: Warm start with initialization data (fields ECEF X, ECEF Y, ECEF Z) 4: Cold start

Table 54: Navigation initialization

Example: Execute hot start (without initialization data)

```
$PSRF101,0,0,0,0,0,0,12,1*15
```

Example: Execute cold start (without initialization data)

```
$PSRF101,0,0,0,0,0,0,12,4*10
```

Example: Execute warm start (with initialization data)

```
$PSRF101,-2686700,-4304200,3851624,96000,497260,921,12,3*1C
```

10.2 OSP sentences

Overall OSP message structure is represented here below. It is the basis for understanding all OSP input and output messages. All messages start with the sequence A0 A2 and end with the sequence B0 B3. The start sequence is followed by payload length, payload, and payload checksum fields. Data format is HEX.

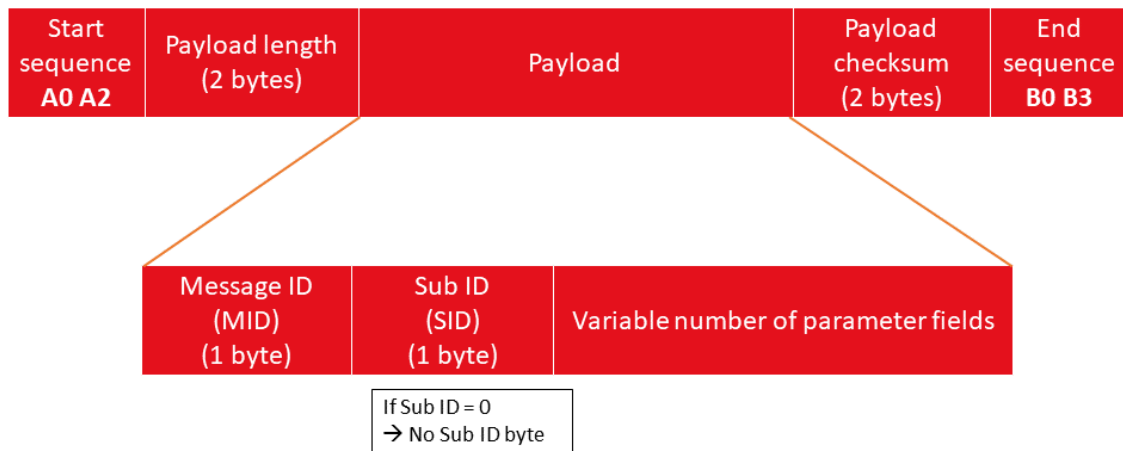

Figure 35: OSP Sentences for Elara-II

The checksum is calculated through the following formula:

$$(\text{Payload_byte1} + \text{Payload_byte2} + \dots + \text{Payload_byteN}) \text{ AND } (0x7FFF)$$

If not differently specified, MSB comes first in all OSP data fields.

Example message with following payload:

- ID 56 (HEX 38) , SubID 95 (HEX 5F)

- 4 bytes of data (all zeros): total payload length (including ID and SubID): 6 bytes (HEX 00 06)

$$\text{Checksum} = (38 + 5F + 00 + 00 + 00 + 00 + 00 + 00) \text{ AND } (7FFF) = 00 97$$

Completing with start and end sequence we obtain:

A0 A2 00 06 38 5F 00 00 00 00 00 97 B0 B3

Data types are indicated in the descriptions through following symbols.

Data Type	Description
n U	Unsigned value of byte length n
n S	Signed value of byte length n
n D	Discrete, bitmapped values occupying n bytes
n F	Floating point number, n is either 4 or 8

Table 55: Data types

10.2.1 OSP sentences overview

MID	Input/Output	Short description	Link to description
MID 67,1	Output	Multiconstellation navigation data	MID67,1
MID 67,16	Output	Multiconstellation satellite data	MID67,16
MID 2	Output	Measure navigation data indication	MID2
MID 51,01	Output	Navigation cycle complete	MID51,1
MID 6	Output	Software version. Response to MID 132	MID6
MID18	Output	Indicates module status	MID18
MID 11	Output	Positive acknowledgement. Indicates successful request.	MID11
MID 12	Output	Negative acknowledgement. Indicates unsuccessful request.	MID12
MID 129	Input	Switch protocol and baud rate.	MID129
MID 134	Input	Switch baud rate.	MID134
MID 132	Input	Poll software version	MID132
MID 222,16	Input	Manage constellation settings	MID222,16
MID 136	Input	Enable/Disable 5 Hz navigation	MID136
MID 218,6	Input	Configure power modes	MID218,6

Table 56: Message overview for OSP messages

10.2.2 OSP output sentences

Most relevant OSP output messages are the ones containing position, time and related information about the position fix. If the module is in full power mode, these are sent automatically with the configured update rate. Other OSP output messages are sent in response to specific commands or events. OSP output message types and corresponding payload fields are explained in the following pictures and table.

- **MID 67,1- Multiconstellation Navigation Data:**

Field	Bytes	Description
ID, optional SubID	2 U	67,1 (HEX 43 01)
Navigation valid	4 D	00 00 00 00: Navigation valid else: Navigation not optimal (<5 SV)
Not supported	4 D	-
GPS Week	2 U	GPS week number. Week 0 starts on 6th January 1980
Time of Week	4 U	Measured in seconds (scaled by 10^3)
Not supported	8 U	-
UTC year	2 U	UTC year
UTC month	1 U	UTC month, 1 to 12
UTC day	1 U	UTC day of month, 1 to 31
UTC hour	1 U	UTC hour, 0 to 23
UTC minute	1 U	UTC minute, 0 to 59
UTC second	2 U	UTC second, 0 to 59.999 in s, scaled by 10^3
UTC offset	1 U	Integer offset between UTC and GPS time (sec)
Model	1 U	21 (HEX 15): WGS84
Not supported	20 U	-
Latitude	4 S	Position Latitude. Positive value indicates North, degrees, scaled by 10^7
Longitude	4 S	Position Longitude. Positive value indicates East, degrees, scaled by 10^7
Altitude (WGS 84)	4 S	Altitude relative to the WGS-84 ellipsoid, meters, scaled by 10^2
Altitude (MSL)	4 S	Altitude from mean sea level: altitude using geoid model, meters, scaled by 10^2
Speed Over Ground	2 U	Speed Over Ground (horizontal component of velocity), m/s, scaled by 10^2
Course Over Ground	2 U	Course over ground, clockwise from true north, degrees, scaled by 10^2

Field	Bytes	Description
Climb rate	2 S	Vertical component of velocity, m/s, scaled by 10^2
Heading rate	2 S	Rate of change of course over ground, deg/sec, scaled by 10^2
Distance traveled	4 U	Distance traveled since reset (m)
Heading error	2 U	Estimate of error in course over ground (COG), degrees, scaled by 10^2
Distance traveled error	2 U	Estimate of error in distance (m)
EHPE	4 U	Estimated Horizontal Position Error (m), scaled by 10^2
EVPE	4 U	Estimated Vertical Position Error (m), scaled by 10^2
EHVE	2 U	Estimated Horizontal Velocity Error (m/s), scaled by 10^2
GDOP	1 U	Geometric Dilution Of Precision, scaled by 5
PDOP	1 U	Position Dilution Of Precision, scaled by 5
HDOP	1 U	Horizontal Dilution Of Precision, scaled by 5
VDOP	1 U	Vertical Dilution Of Precision, scaled by 5
TDOP	1 U	Time Dilution Of Precision, scaled by 5
Satellites used	1 U	Number of satellites used in solution
SV List (1)	4 D	List of GPS satellites used in solution (Bits 0-31: PRNs 1-31)
SV List (2)	4 D	List of SBAS satellites used in solution (Bits 0-18: PRNs 1-18)
SV List (3)	4 D	List of GLONASS satellites used in solution (Bits 0-23: Slot Numbers 1-24)
SV List (4)	4 D	List of QZSS satellites used in solution. Bits [0:4] correspond to Slot Numbers 193-197 Bits [5:9] future QZSS satellites 198-202 Bits [10:14] not supported
Not supported	8 D	Not supported

Table 57: MID 67,1 - Multiconstellation Navigation Data

An example of this message is:

```
A0 A2 00 7E 43 01 00 00 00 00 00 00 04 08 25 12 C7 F0 07 00 0F 41 DF 00
00 02 01 07 E3 0C 19 0F 1F 42 10 15 E1 00 00 00 41 B8 03 48 00 00 00 00 00 1B 7B
24 00 00 00 00 1C B3 1C 9A 06 E7 7A 42 00 00 D4 8A 00 00 C1 F7 00 00 60 22 00
00 00 00 00 00 00 00 00 00 00 00 00 02 DC 00 00 05 C2 00 02 0E 0C 06 0B 07 09
54 16 00 30 00 00 00 00 00 00 02 00 00 00 00 00 00 00 00 00 00 00 00 00 03 08 11 B1 B0
B3
```

- **MID 67,16 - Multiconstellation Satellite Data:**

Field	Bytes	Description
ID, optional SubID	2 U	67,16 (HEX 43 10)
GPS Week	2 U	GPS week number. Week 0 starts on 6th January 1980
Time of Week	4 U	Measured in seconds (scaled by 10^3)
Not supported	8	-
Messages info	1 U	Bits 7 - 4: number of messages in this group Bits 3 - 0: message number within the group
Number of sats	1 U	Total number of satellites reported in this group of messages (range 1-15)
Satellite	[15] × 12	Repetitions of data pattern described in table 59: MID 67,16 - Satellite information

Table 58: MID 67,16 - Multiconstellation Satellite Data

Field	Bytes	Description
Satellite info	2 U	Satellite information and status, packed as follows: Bits [15:13]: Constellation type enumeration 0 = GPS/QZSS 1 = SBAS 2 = GLONASS other: reserved Bits [12:8]: Other info For GLONASS, frequency channel -7 to 6. For SBAS 0 = WAAS 1 = EGNOS 2 = MSAS 3 = GAGAN other: reserved [Bits 7:0] : ID For GPS and SBAS, this field reports PRN. For GLONASS, Slot Number 1-24.
Azimuth	2 U	Satellite azimuth angle, degrees, clockwise from true north, scaled by 10
Elevation	2 U	Satellite elevation angle above horizon, degrees, scaled by 10
Carrier-to-noise	2 U	Average Carrier-to-noise ratio, dB-Hz, scaled by 10
Status	4 D	Satellite status. Following description of each bit is effective when the specified bit is set. Bit 0: successful acquisition/re-acquisition Bit [1:5]: not supported Bit 6: reserved Bit 7: ephemeris data is available. Bits [8:14]: reserved Bit 15: satellite used in solution. Bits [16:31]: reserved

Table 59: MID 67,16 - Satellite information

An example of this message is:

```
A0 A2 00 C6 43 10 08 25 13 0E E7 FF 00 0F 41 FC 00 00 02 01 21 1A 00 15 09 3A
03 36 01 92 00 00 82 BF 00 06 0B B1 02 94 01 90 00 00 82 BF 00 13 0B A9 02 61 01
91 00 00 82 BF 00 1B 0B AA 02 41 01 91 00 00 82 BF 00 12 04 0F 01 FA 01 91 00 00
82 BF 00 1D 03 F3 01 31 01 91 00 00 82 BF 00 05 01 D8 00 F3 01 91 00 00 82 BF 00
16 06 F7 00 E0 01 90 00 00 82 BF 00 20 06 AC 00 D8 01 8B 00 00 82 BF 00 10 0C
61 00 CC 01 91 00 00 82 BF 00 07 0C 5C 00 88 01 92 00 00 82 BF 00 1F 09 0B 00
57 01 91 00 00 82 BF 00 0F 02 06 00 4F 01 92 00 00 82 BF 00 C1 0B AF 00 B2 00 00
00 00 00 00 00 1A 01 5C 00 2B 00 00 00 00 00 00 2D BB B0 B3
```

- **MID 2 - Measure Navigation Data Indication:**

Field	Bytes	Description
ID	1 U	2 (HEX 02)
ECEF X	4 S	X position (ECEF system), meters
ECEF Y	4 S	Y position (ECEF system), meters
ECEF Z	4 S	Z position (ECEF system), meters
ECEF vel X	2 S	X velocity (ECEF system), m/s, scaled by 8
ECEF vel Y	2 S	Y velocity (ECEF system), m/s, scaled by 8
ECEF vel Z	2 S	Z velocity (ECEF system), m/s, scaled by 8
Not supported	1	-
HDOP	1 U	Horizontal Dilution Of Precision, scaled by 5
Not supported	1	-
GPS Week	2 U	GPS week number. Week 0 starts on 06.01.1980
Time of Week	4 U	Measured in seconds (scaled by 10 ³)
Satellites used	1 U	Number of satellites used in solution, 0 to 18
SV used	[18]	Satellite ID (see table 61: for PRN mapping)

Table 60: MID 2 - Measure Navigation Data Indication

Value	Constellation	Description
0	None	No report
1-32	GPS	Satellite PRN code
65-88	GLONASS	Channel (-7 to +6) + 77
120-138	GPS SBAS	SBAS PRN code
173-187, 193-202	QZSS	Satellite PRN code

Table 61: Satellite PRN mapping

An example of this message is:

```
A2 00 2F 02 00 55 F8 C6 00 1F 4A 89 00 21 13 92 00 00 00 00 00 00 04 04 02 00 23
02 35 8D 40 0A 17 11 01 13 0D 1F 0B 14 03 20 00 00 00 00 00 00 00 00 05 B2 B0 B3
```

- **MID 51,1:**

MID 51,1 is sent at the end of every navigation cycle and indicates that all messages for this cycle have been sent.

Field	Bytes	Description
ID, optional SubID	2 U	51,01 (HEX 33 01)
Reserved	1 U	Reserved (set to 0)

Table 62: MID 51,1 - Navigation Cycle Complete

The complete sentence is:

A0 A2 00 03 33 01 00 00 34 B0 B3

- **MID 6:**

MID 6 is sent from the receiver in response to poll SW version command (MID 132).

Field	Bytes	Description
ID	1 U	6 (HEX 06)
Length SiRF SW Version	1 U	Size of SiRF SW version field including terminating 0x00
Length Customer SW Version	1 U	Size of Customer SW version field including terminating 0x00
SiRF SW Version	specified in field Length SiRF SW Version	SiRF SW version as ASCII. Terminated by 0x00
Customer SW Version	specified in field Length Customer SW Version	Customer SW version as ASCII (optional). Terminated by 0x00

Table 63: MID 6 - SW Version

An example of this message with SiRF software version "5xp__5.5.2-R32+5xpt_5.5.2-R32" and undefined Customer SW Version:

A0 A2 00 22 06 1E 01 35 78 70 5F 5F 35 2E 35 2E 32 2D 52 33 32 2B 35 78 70 74 5F 35 2E 35 2E 32 2D 52 33 32 00 00 07 D3 B0 B3

- **MID 18:**

MID 18 is sent from the receiver to indicate status and if communication with host is possible.

Field	Bytes	Description
ID	1 U	18 (HEX 12)
Send indicator	1 U	0: Receiver is about to be in sleep mode (HEX 00) 1: Receiver is not in sleep mode (HEX 01)

Table 64: MID 18 - Ok To Send

Example of Ok To Send at module start-up:

A0 A2 00 02 12 01 00 13 B0 B3

- **MID 11:**

MID 11 is sent from the receiver to indicate that a request from host was accepted and successfully executed (ACK).

Field	Bytes	Description
ID	1 U	11 (HEX 0B)
Send indicator	1 U	ID of the successful request
Send indicator	1 U	SubID of the successful request

Table 65: MID 11 - Command Acknowledgment Response

Example of ACK for poll SW version request (MID 132, HEX 84):

A0 A2 00 03 0B 84 00 8F B0 B3

- **MID 12:**

MID 12 is sent from the receiver to indicate that a request from host failed (NACK).

Field	Bytes	Description
ID	1 U	12 (HEX 0C)
Send indicator	1 U	ID of the failed request
Send indicator	1 U	SubID of the failed request

Table 66: MID 12 - Command Negative Acknowledgment Response

Example of NACK for poll SW version request (MID 132, HEX 84):

A0 A2 00 03 0C 84 00 90 B0 B3

10.2.3 OSP input sentences

Most relevant OSP input message types and corresponding payload fields are described in the following pictures and table.

- **MID 129:**

MID 129 switches the protocol to NMEA with the desired baud and messages rate configuration.

Field	Bytes	Description
ID	1 U	129 (HEX 81)
Mode	1 U	0: Enable NMEA debug messages 1: Disable NMEA debug messages
NMEA config	[10] × 2U	Array specifying output rate for each NMEA message. Mapping inside the array: GGA, GLL, GSA, GSV, RMC, VTG, MSS, EPE, ZDA, unused. Entry (2 bytes) for each message: 1 U: number of seconds between reports. If 0 (HEX 00): no reports. 1 U: 1 (HEX 01)
Baud rate	2 U	Valid baud rates: 4800, 9600, 19200, 38400, 57600

Table 67: MID 129 - Switch NMEA protocol request

Example: switch to NMEA, with: baud rate 4800, GGA, GLL, GSA, GSV, RMC, VTG messages active at 1 Hz (1 msg/sec)

Start sequence: A0 A2

Length: 24 (HEX 00 18)

ID: 129 (HEX 81)

Mode: 0 (HEX 00)

NMEA config: 0101 0101 0101 0101 0101 0101 0001 0001 0001 0101

baud rate: 4800 (HEX 12C0)

Checksum: 0164

End sequence: B0B3

The complete message is therefore:

```
A0 A2 00 18 81 00 01 01 01 01 01 01 01 01 01 01 01 01 00 01 00 01 00 01 01 01
01 12 C0 01 64 B0 B3
```

- **MID 134:**

MID 134 switches the baud rate without changing the protocol.

Field	Bytes	Description
ID	1 U	134 (HEX 86)
Mode	4 U	Valid baud rates: 4800 9600 19200 38400 57600 115200 230400 460800 921600 1228800
Data bits	1 U	Valid bits per byte: 8 (HEX 08)
Stop bits	1 U	Valid number of stop bits: 1 (HEX 01)
Parity	1 U	0: none (HEX 00)
Reserved	1 U	0 (HEX 00)

Table 68: MID 134 - Baud rate selection

Example: set baud rate 4800

A0 A2 00 09 86 00 00 12 C0 08 01 00 00 01 61 B0 B3

- **MID 132:**

MID 132 request software version. Module responds with MID 6.

Field	Bytes	Description
ID	1 U	132 (HEX 84)
Reserved	1 U	Reserved (set to 0)

Table 69: MID 132 - SW version request

Full sentence is:

A0 A2 00 02 84 00 00 84 B0 B3

- **MID 222,16:**

MID 222,16 manages constellation settings.

Field	Bytes	Description
ID	2 U	222,16 (HEX 0xDE,0x10)
Reserved	3 U	Reserved (set to 0)
PrimConst.	1 U	Primary GNSS constellation 0: GPS 1: GLONASS
TechSet	2 U	GNSS technologies (enabled when set to 1) Bit [15:9]: Reserved (set to 0) Bit 8: not supported (set to 0) Bit 7: GPS L1C Bit 6: QZSS-IMES Bit 5: QZSS Bit 4: SBAS Bit 3: not supported (set to 0) Bit 2: not supported (set to 0) Bit 1: GLONASS Bit 0: GPS
Not supported	2 U	Not supported (set to 0)
Reserved	4 U	Reserved (set to 0)

Table 70: MID 222,16 - Location Technology Constraints Request

Example: set GPS-GLONASS mode

A0 A2 00 0E DE 10 00 00 00 00 00 03 00 00 00 00 00 00 F1 B0B3

Example: set GLONASS-only mode

A0 A2 00 0E DE 10 00 00 00 01 00 02 00 00 00 00 00 00 F1 B0 B3

Example: set GPS-only mode

A0 A2 00 0E DE 10 00 00 00 00 00 01 00 00 00 00 00 00 EF B0 B3

- **MID 136:**

This message enables and disables 5 Hz navigation

Field	Bytes	Description
ID	1 U	136 (HEX 88)
Reserved	2 U	Reserved (set to 0)
Degraded mode	1 U	Disabled: 04
Pos. Mode	1 D	5 Hz navigation enabled: 0x04 5 Hz navigation disabled: 0x00
Reserved	7 U	Reserved (set to 0)
TimeOut	1 U	Range: 1 to 120 s (default 5 s). If signal is lost, last computed position continues to be reported after this time.
AcqAndTrack	1 D	<p>Bit [7:5]: Reserved</p> <p>Bit [4:3]: Channel usage: provides a means to control power used during acquisition and tracking (navigation). "Full" uses all resources available and the most power. "Limited" uses less power and restricts usage to the minimum necessary to find satellites.</p> <p>00 = Acquisition and navigation are full 01 = Acquisition is limited, navigation is full 10 = Acquisition is full, navigation is limited 11 = Acquisition and navigation are limited</p> <p>Bit 2: High sensitivity tracking loop. If this bit is disabled, power usage is reduced while trading high sensitivity.</p> <p>0 = Enable tracking loop 1 = Disable tracking loop</p> <p>Bit 1: Smoothed measurements 0 = Use raw measurements 1 = Use smooth measurements</p> <p>Bit 0: Track smoothing</p> <p>0 = Disable track smoothing 1 = Enable track smoothing</p>

Table 72: MID 136 - Mode control

Example: enable 5 Hz navigation (no track smoothing, smoothed measurements active, tracking loop disabled, acquisition and navigation limited)

A0 A2 00 0E 88 00 00 04 04 00 00 00 00 00 00 0F 1A 00 B9 B0 B3

- **MID 218,6:**

This message can be used to activate and configure available low power modes.

Field	Bytes	Description
ID, optional SubID	2 U	218,6 (HEX 0xDA 0x06)
PowerMode	1 U	Power mode selection 0: Full Power Mode 1: Low Power Mode
Not supported	1 U	Not supported (set to 0)
Version	1 U	Set to 0
LPM rate (upper)	1 U	Upper byte of LPM rate in seconds The value for the LPM rate is computed by combining the value in this field multiplied by 2^{16} and adding to LPM rate (lower).
LPM rate (lower)	2 U	Lower 2 bytes of the LPM rate in seconds Special values of the LMP rate indicate: - If useMask bit 2 is 0: Trickle Power. - If useMASK bit 2 is 1: Push-To-Fix - 1 to 29: Value is rounded to a multiple of 6 - 30 to 86400: Value is rounded to a multiple of 30
UseMask	2 D	Use mask bitmap bit 0: 0: Use LPM defaults 1: Change LPM settings using the corresponding fields below. bit 1: Reserved (set to 0) bit 2: 0: Use Trickle Power 1: Enable PTF at 6s Bit [3-15]: Reserved (set to 0)
MAX_SEARCH_TIME (TP and PTF)	2 U	Max Search Time of acquisition attempts (sec) Valid for both TP and Push-to-Fix. Rounded to a multiple of 30 seconds for PTF. Default: 120 s
MAX_OFF_TIME (TP and PTF)	2 U	Max Off Time when the search fails (sec) Valid for both TP and Push-to-Fix. Rounded to a multiple of 30 seconds for PTF. Default: 30 s
Not supported	6 U	Not supported (set to 0)
RF ON Time (TP only)	2 U	Amount of time for RF to be on for signal acquisition Units: ms, range: 100 to 800 ms (100 ms intervals), recommended 200 ms
Reserved	20 U	Reserved (set to 0)

Table 73: MID 218,6 - Low Power Mode Request

Example: set Trickle Power mode with:

```
rate = 10 s
RF ON time = 200 ms
MAX_OFF_TIME = 30 s
MAX_SEARCH_TIME = 120 s
```

```
A0 A2 00 2A DA 06 01 00 00 00 00 0A 00 01 00 78 00 1E 00 00 00 00 00 00 00
C8 00 00 00 04 00 00 00 00 00 00 00 00 00 00 00 00 00 00 00 00 02 4E B0 B3
```

Example: set Push To Fix with:

```
rate = 10 s
RF ON time = 200 ms
MAX_OFF_TIME = 30 s
MAX_SEARCH_TIME = 120 s
```

```
A0 A2 00 2A DA 06 01 00 00 00 00 1E 00 05 00 5A 00 3C 00 00 00 00 00 00 00
00 00 00 00 04 00 00 00 00 00 00 00 00 00 00 00 00 00 00 00 01 9E B0 B3
```

The sleep times and the LPM rates can be verified through:

- the flow of messages from the module: no messages during sleep times, flow starts again during full power time slots
- Ok To Send and Not Ok To Send messages: sent from the module at every transition full power/sleep
- LEDs on module EV-Board (if used)

11 UserSettings

Default configuration of the module is stored in module's GNSS chipset. As this is a ROM-based unit, changing default settings is not possible. All changes to settings made during runtime are volatile.

While in full power mode, software commands described in this manual allow partial changing of this configuration. Power cycling the module, as well as performing a factory reset, causes the loss of these volatile changes and returning to the default settings as shown below.

11.1 Default Settings

Setting	State
Power On State	Hibernate
Data Format	NMEA
UART Settings	4800 bps, 8 data bits, no parity, one stop bit
I ² C Settings	Multi-Master, 400 kbps
SPI Settings	Slave, up to 6.8 MHz
Satellite Constellation	GPS, GLONASS (+SBAS)
NMEA Messages	\$GPGGA, \$GNGNS, \$GNGSA, \$GNRMC: 1 msg/1 sec; \$GPGSV, \$GLGSV: 1 msg/5 sec

Table 74: Default ROM Settings

12 Manufacturing information

12.1 Moisture sensitivity level

This wireless connectivity product is categorized as JEDEC Moisture Sensitivity Level 3 (MSL3), which requires special handling.

More information regarding the MSL requirements can be found in the IPC/JEDEC J-STD-020 standard on www.jedec.org.

More information about the handling, picking, shipping and the usage of moisture/reflow and/or process sensitive products can be found in the IPC/JEDEC J-STD-033 standard on www.jedec.org.

12.2 Soldering

12.2.1 Reflow soldering

Attention must be paid on the thickness of the solder resist between the host PCB top side and the modules bottom side. Only lead-free assembly is recommended according to JEDEC J-STD020.

Profile feature		Value
Preheat temperature Min	$T_{S \text{ Min}}$	150°C
Preheat temperature Max	$T_{S \text{ Max}}$	200°C
Preheat time from $T_{S \text{ Min}}$ to $T_{S \text{ Max}}$	t_S	60 - 120 seconds
Ramp-up rate (T_L to T_P)		3°C / second max.
Liquidous temperature	T_L	217°C
Time t_L maintained above T_L	t_L	60 - 150 seconds
Peak package body temperature	T_P	see table below
Time within 5°C of actual peak temperature	t_P	20 - 30 seconds
Ramp-down Rate (T_P to T_L)		6°C / second max.
Time 20°C to T_P		8 minutes max.

Table 75: Classification reflow soldering profile, Note: refer to IPC/JEDEC J-STD-020E

Package thickness	Volume mm ³ <350	Volume mm ³ 350-2000	Volume mm ³ >2000
< 1.6mm	260 °C	260 °C	260 °C
1.6mm - 2.5mm	260 °C	250 °C	245 °C
> 2.5mm	250 °C	245 °C	245 °C

Table 76: Package classification reflow temperature, PB-free assembly, Note: refer to IPC/-JEDEC J-STD-020E



Compared to IPC/JEDEC J-STD-020E standard, peak temperature shall not exceed 245 °C.

It is recommended to solder this module on the last reflow cycle of the PCB. For solder paste use a LFM-48W or Indium based SAC 305 alloy (Sn 96.5 / Ag 3.0 / Cu 0.5 / Indium 8.9HF / Type 3 / 89%) type 3 or higher.

The reflow profile must be adjusted based on the thermal mass of the entire populated PCB, heat transfer efficiency of the reflow oven and the specific type of solder paste used. Based on the specific process and PCB layout the optimal soldering profile must be adjusted and verified. Other soldering methods (e.g. vapor phase) have not been verified and have to be validated by the customer at their own risk. Rework is not recommended.

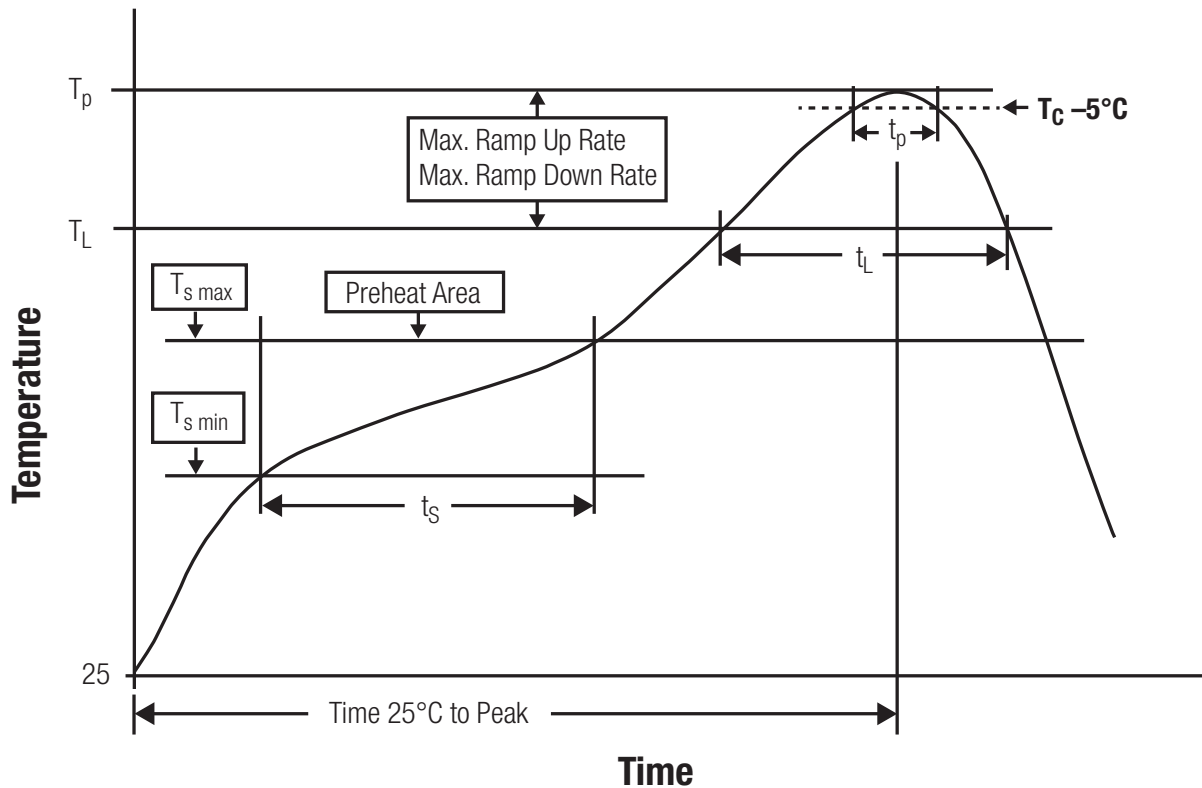

Figure 36: Reflow soldering profile

After reflow soldering, visually inspect the board to confirm proper alignment

12.2.2 Cleaning

Do not clean the product. Any residue cannot be easily removed by washing. Use a "no clean" soldering paste and do not clean the board after soldering.

- Do not clean the product with water. Capillary effects can draw water into the gap between the host PCB and the module, absorbing water underneath it. If water is trapped inside, it may short-circuit adjoining pads. The water may also destroy the label and ink-jet printed text on it.
- Cleaning processes using alcohol or other organic solvents may draw solder flux residues into the housing, which won't be detected in a post-wash inspection. The solvent may also destroy the label and ink-jet printed text on it.
- Do not use ultrasonic cleaning as it will permanently damage the part, particularly the crystal oscillators.

12.2.3 Other notations

- Conformal coating of the product will result in the loss of warranty. The RF shields will not protect the part from low-viscosity coatings.

- Do not attempt to improve the grounding by forming metal strips directly to the EMI covers or soldering on ground cables, as it may damage the part and will void the warranty.
- Always solder every pad to the host PCB even if some are unused, to improve the mechanical strength of the module.
- The part is sensitive to ultrasonic waves, as such do not use ultrasonic cleaning, welding or other processing. Any ultrasonic processing will void the warranty.

12.3 ESD handling

This product is highly sensitive to electrostatic discharge (ESD). As such, always use proper ESD precautions when handling. Make sure to handle the part properly throughout all stages of production, including on the host PCB where the module is installed. For ESD ratings, refer to the module series' maximum ESD section. For more information, refer to the relevant chapter 2. Failing to follow the aforementioned recommendations can result in severe damage to the part.

- the first contact point when handling the PCB is always between the local GND and the host PCB GND, unless there is a galvanic coupling between the local GND (for example work table) and the host PCB GND.
- Before assembling an antenna patch, connect the grounds.
- While handling the RF pin, avoid contact with any charged capacitors and be careful when contacting any materials that can develop charges (for example coaxial cable with around 50-80 pF/m, patch antenna with around 10 pF, soldering iron etc.)
- Do not touch any exposed area of the antenna to avoid electrostatic discharge. Do not let the antenna area be touched in a non ESD-safe manner.
- When soldering, use an ESD-safe soldering iron.

12.4 Safety recommendations

It is your duty to ensure that the product is allowed to be used in the destination country and within the required environment. Usage of the product can be dangerous and must be tested and verified by the end user. Be especially careful of:

- Use in areas with risk of explosion (for example oil refineries, gas stations).
- Use in areas such as airports, aircraft, hospitals, etc., where the product may interfere with other electronic components.

It is the customer's responsibility to ensure compliance with all applicable legal, regulatory and safety-related requirements as well as applicable environmental regulations. Disassembling the product is not allowed. Evidence of tampering will void the warranty.

- Compliance with the instructions in the product manual is recommended for correct product set-up.
- The product must be provided with a consolidated voltage source. The wiring must meet all applicable fire and security prevention standards.

- Handle with care. Avoid touching the pins as there could be ESD damage.

Be careful when working with any external components. When in doubt consult the technical documentation and relevant standards. Always use an antenna with the proper characteristics.



Würth Elektronik eiSos radio modules with high output power of up to 500 mW, as for example the radio module Thebe-II, generate a high amount of warmth while transmitting. The manufacturer of the end device must take care of potentially necessary actions for his application.

13 Physical dimensions

13.1 Dimensions

Dimensions
4.10 * 4.10 * 2.20 mm

Table 77: Dimensions

Tolerances: see chapter 13.3

13.2 Weight

Weight
0.10 g

Table 78: Weight

Tolerance: ± 0.05 g

13.3 Module drawing

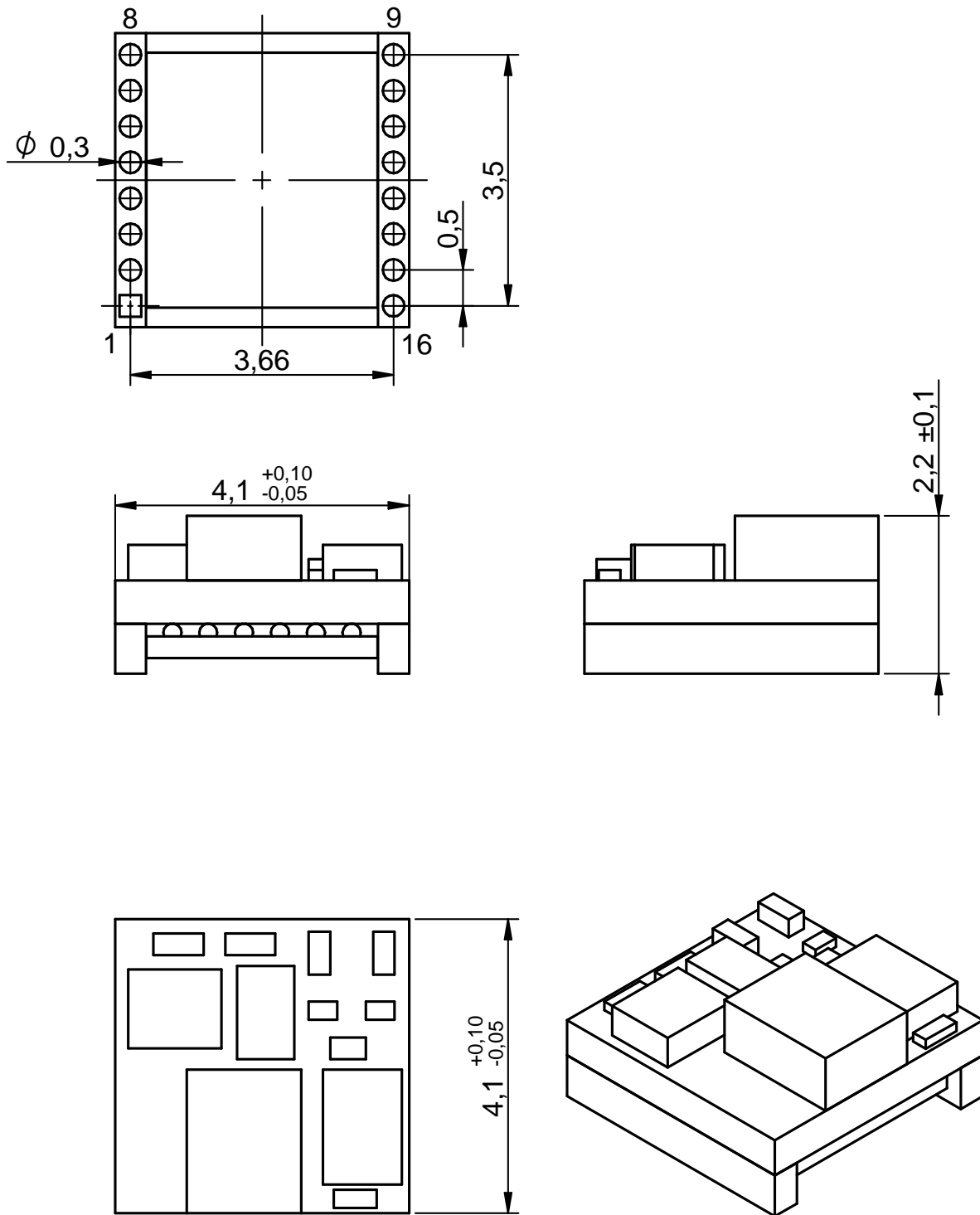

Figure 37: Module dimensions [mm]

13.4 Footprint

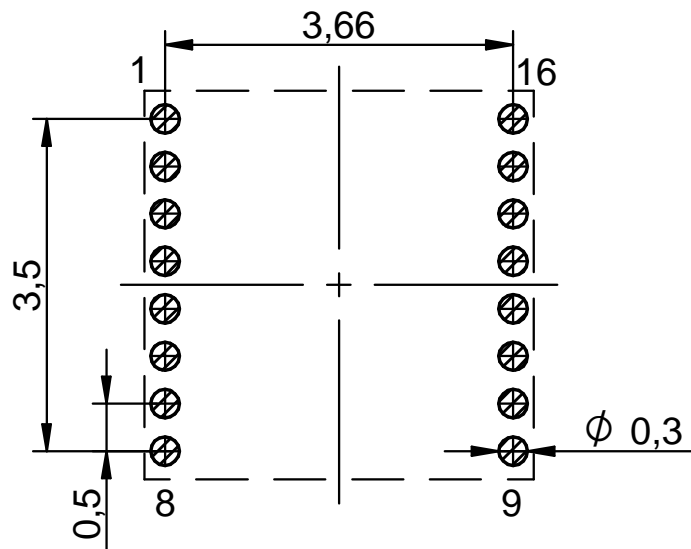

Figure 38: Footprint and dimensions [mm]

14 Marking

14.1 Lot number

The 15 digit lot number is printed in numerical digits as well as in form of a machine readable bar code. It is divided into 5 blocks as shown in the following picture and can be translated according to the following table.

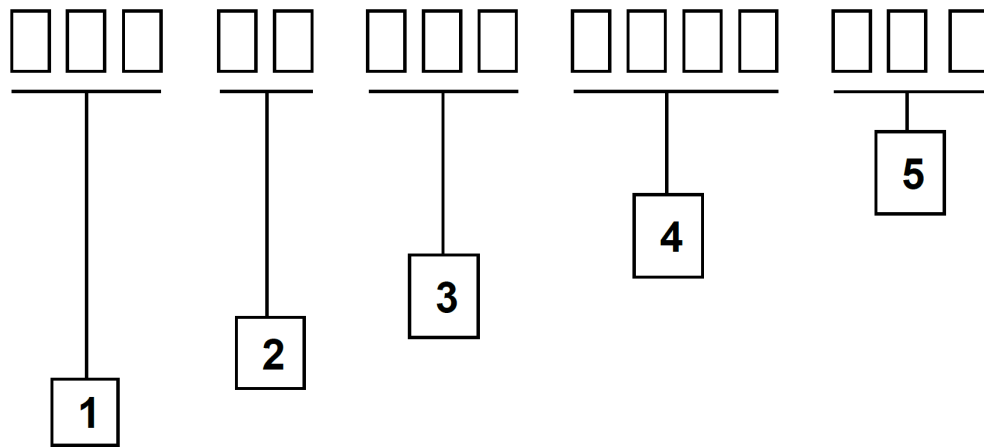

Figure 39: Lot number structure

Block	Information	Example(s)
1	WE eiSos internal, 3 digits	439
2	WE eiSos internal, 2 digits	01
3	Hardware version, 3 digits	V2.4 = 024, V12.2 = 122
4	Date code, 4 digits	1703 = week 03 in year 2017, 1816 = week 16 in year 2018
5	Firmware version, 3 digits	V3.2 = 302, V5.13 = 513

Table 79: Lot number details

15 References

- [1] Würth Elektronik. Application note "GNSS Antenna Selection". <https://www.we-online.com/ANR017>.
- [2] Würth Elektronik. Application note "GNSS I2C Communication". <https://www.we-online.com/ANR018>.
- [3] Würth Elektronik. Elara-II evaluation board user manual. <https://we-online.de/katalog/en/manual/2613029237001>.
- [4] Würth Elektronik. GNSS antenna 7488920157. <https://www.we-online.de/catalog/en/WE-MCA#7488920157>.
- [5] Würth Elektronik. GNSS antenna Halimede-I. <https://www.we-online.de/katalog/en/HALIMEDE-I>.
- [6] Würth Elektronik. RF Modules Altium library. <https://www.we-online.com/WCO-ALTIUM>.
- [7] Würth Elektronik. RF Modules Eagle library. <https://www.we-online.com/WCO-EAGLE>.
- [8] Würth Elektronik. WENSS PC tool. <https://www.we-online.com/WENSS>.
- [9] Würth Elektronik. Würth Elektronik eiSos GNSS Evaluation Kits. <https://www.we-online.com/EVAL-GNSS>.

16 Regulatory compliance information

16.1 Important notice EU

The use of RF frequencies is limited by national regulations. The Elara-II has been designed to comply with the R&TTE directive 1999/5/EC and the RED directive 2014/53/EU of the European Union (EU).

The Elara-II can be operated without notification and free of charge in the area of the European Union. However, according to the R&TTE / RED directive, restrictions (e.g. in terms of duty cycle or maximum allowed RF power) may apply.



Since the module itself is not fused the voltage supply shall be fed from a power source which is class PS2 according to EN 62368-1.

16.2 Important notice FCC

The use of RF frequencies is limited by national regulations. The Elara-II has been designed to comply with the FCC Part 15.

The Elara-II can be operated without notification and free of charge in the area of the United States of America. However, according to the FCC Part 15, restrictions (e.g. in terms of maximum allowed RF power and antenna) may apply.

16.3 Conformity assessment of the final product

The Elara-II is a subassembly. It is designed to be embedded into other products (products incorporating the Elara-II are henceforward referred to as "final products").

It is the responsibility of the manufacturer of the final product to ensure that the final product is in compliance with the essential requirements of the underlying national radio regulations. The conformity assessment of the subassembly Elara-II carried out by Würth Elektronik eiSos does not replace the required conformity assessment of the final product.

16.4 Exemption clause

Relevant regulation requirements are subject to change. Würth Elektronik eiSos does not guarantee the accuracy of the before mentioned information. Directives, technical standards, procedural descriptions and the like may be interpreted differently by the national authorities. Equally, the national laws and restrictions may vary with the country. In case of doubt or uncertainty, we recommend that you consult with the authorities or official certification organizations of the relevant countries. Würth Elektronik eiSos is exempt from any responsibilities or liabilities related to regulatory compliance.

Notwithstanding the above, Würth Elektronik eiSos makes no representations and warranties of any kind related to their accuracy, correctness, completeness and/or usability for customer applications. No responsibility is assumed for inaccuracies or incompleteness.

16.5 EU Declaration of conformity

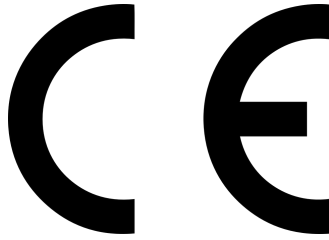

EU DECLARATION OF CONFORMITY

Radio equipment: 2613021137000
Product name: Elara-II
Receiver module for GPS and GLONASS signals
Lot number: 497 01 03 1952 001 and all more recent lots

The manufacturer: Würth Elektronik eiSos GmbH & Co. KG
Max-Eyth-Straße 1
74638 Waldenburg

This declaration of conformity is issued under the sole responsibility of the manufacturer.

Object of the declaration: 2613021137000

The object of the declaration described above is in conformity with the relevant Union harmonisation legislation: Directive 2014/53/EU and 2011/65/EU.

Following harmonised norms or technical specifications have been applied:

EN 303 413 V1.1.1 (2017-06)
EN 301 489-1 V2.2.3 (2019-11)
EN 301 489-19 V2.1.1 (2019-04)
EN 62368-1: 2014/AC: 2015/A11: 2017

i.A. G. Eslerdt

Trier, 13th of January 2020
Place and date of issue

16.6 FCC conformity

The Elara-II is a pure receiver without any transmitting capability. Therefore, no applicable certification exists. Nevertheless, the end device has to be tested for the requirements as per FCC CFR Title 47 chapter I sub chapter A Part 15 Subpart B, unintentional radiators.

Due to the fact, that the Elara-II is intended to receive non-U.S.-licensed space stations §25.137 of CFR Title 47 chapter I sub chapter B Part 25 Subpart B has to be considered. The FCC Form 312 has to be submitted to the international Bureau Filing System.

https://www.ecfr.gov/cgi-bin/retrieveECFR?gp=&SID=b5653e2553e10fdf141e336593203a6d&mc=true&n=pt47.2.25&r=PART&ty=HTML#se47.2.25_1137

In case of non-federal U.S. receive-only earth stations operating with specific Galileo signals, a waiver permits the use of E1 and E5 bands without license or grant of market access.

<https://docs.fcc.gov/public/attachments/FCC-18-158A1.pdf>

It is the integrator's responsibility to configure the GNSS module in such a way, that only permitted bands are used.

17 Important notes

The following conditions apply to all goods within the wireless connectivity product range of Würth Elektronik eiSos GmbH & Co. KG:

17.1 General customer responsibility

Some goods within the product range of Würth Elektronik eiSos GmbH & Co. KG contain statements regarding general suitability for certain application areas. These statements about suitability are based on our knowledge and experience of typical requirements concerning the areas, serve as general guidance and cannot be estimated as binding statements about the suitability for a customer application. The responsibility for the applicability and use in a particular customer design is always solely within the authority of the customer. Due to this fact, it is up to the customer to evaluate, where appropriate to investigate and to decide whether the device with the specific product characteristics described in the product specification is valid and suitable for the respective customer application or not. Accordingly, the customer is cautioned to verify that the documentation is current before placing orders.

17.2 Customer responsibility related to specific, in particular safety-relevant applications

It has to be clearly pointed out that the possibility of a malfunction of electronic components or failure before the end of the usual lifetime cannot be completely eliminated in the current state of the art, even if the products are operated within the range of the specifications. The same statement is valid for all software sourcecode and firmware parts contained in or used with or for products in the wireless connectivity and sensor product range of Würth Elektronik eiSos GmbH & Co. KG. In certain customer applications requiring a high level of safety and especially in customer applications in which the malfunction or failure of an electronic component could endanger human life or health, it must be ensured by most advanced technological aid of suitable design of the customer application that no injury or damage is caused to third parties in the event of malfunction or failure of an electronic component.

17.3 Best care and attention

Any product-specific data sheets, manuals, application notes, PCN's, warnings and cautions must be strictly observed in the most recent versions and matching to the products firmware revisions. This documents can be downloaded from the product specific sections on the wireless connectivity homepage.

17.4 Customer support for product specifications

Some products within the product range may contain substances, which are subject to restrictions in certain jurisdictions in order to serve specific technical requirements. Necessary information is available on request. In this case, the field sales engineer or the internal sales person in charge should be contacted who will be happy to support in this matter.

17.5 Product improvements

Due to constant product improvement, product specifications may change from time to time. As a standard reporting procedure of the Product Change Notification (PCN) according to the JEDEC-Standard, we inform about major changes. In case of further queries regarding the PCN, the field sales engineer, the internal sales person or the technical support team in charge should be contacted. The basic responsibility of the customer as per section 17.1 and 17.2 remains unaffected. All wireless connectivity module driver software "wireless connectivity SDK" and its source codes as well as all PC software tools are not subject to the Product Change Notification information process.

17.6 Product life cycle

Due to technical progress and economical evaluation we also reserve the right to discontinue production and delivery of products. As a standard reporting procedure of the Product Termination Notification (PTN) according to the JEDEC-Standard we will inform at an early stage about inevitable product discontinuance. According to this, we cannot ensure that all products within our product range will always be available. Therefore, it needs to be verified with the field sales engineer or the internal sales person in charge about the current product availability expectancy before or when the product for application design-in disposal is considered. The approach named above does not apply in the case of individual agreements deviating from the foregoing for customer-specific products.

17.7 Property rights

All the rights for contractual products produced by Würth Elektronik eiSos GmbH & Co. KG on the basis of ideas, development contracts as well as models or templates that are subject to copyright, patent or commercial protection supplied to the customer will remain with Würth Elektronik eiSos GmbH & Co. KG. Würth Elektronik eiSos GmbH & Co. KG does not warrant or represent that any license, either expressed or implied, is granted under any patent right, copyright, mask work right, or other intellectual property right relating to any combination, application, or process in which Würth Elektronik eiSos GmbH & Co. KG components or services are used.

17.8 General terms and conditions

Unless otherwise agreed in individual contracts, all orders are subject to the current version of the "General Terms and Conditions of Würth Elektronik eiSos Group", last version available at www.we-online.com.

18 Legal notice

18.1 Exclusion of liability

Würth Elektronik eiSos GmbH & Co. KG considers the information in this document to be correct at the time of publication. However, Würth Elektronik eiSos GmbH & Co. KG reserves the right to modify the information such as technical specifications or functions of its products or discontinue the production of these products or the support of one of these products without any written announcement or notification to customers. The customer must make sure that the information used corresponds to the latest published information. Würth Elektronik eiSos GmbH & Co. KG does not assume any liability for the use of its products. Würth Elektronik eiSos GmbH & Co. KG does not grant licenses for its patent rights or for any other of its intellectual property rights or third-party rights.

Notwithstanding anything above, Würth Elektronik eiSos GmbH & Co. KG makes no representations and/or warranties of any kind for the provided information related to their accuracy, correctness, completeness, usage of the products and/or usability for customer applications. Information published by Würth Elektronik eiSos GmbH & Co. KG regarding third-party products or services does not constitute a license to use such products or services or a warranty or endorsement thereof.

18.2 Suitability in customer applications

The customer bears the responsibility for compliance of systems or units, in which Würth Elektronik eiSos GmbH & Co. KG products are integrated, with applicable legal regulations. Customer acknowledges and agrees that it is solely responsible for compliance with all legal, regulatory and safety-related requirements concerning its products, and any use of Würth Elektronik eiSos GmbH & Co. KG components in its applications, notwithstanding any applications-related information or support that may be provided by Würth Elektronik eiSos GmbH & Co. KG. Customer represents and agrees that it has all the necessary expertise to create and implement safeguards which anticipate dangerous consequences of failures, monitor failures and their consequences lessen the likelihood of failures that might cause harm and take appropriate remedial actions. The customer will fully indemnify Würth Elektronik eiSos GmbH & Co. KG and its representatives against any damages arising out of the use of any Würth Elektronik eiSos GmbH & Co. KG components in safety-critical applications.

18.3 Trademarks

AMBER wireless is a registered trademark of Würth Elektronik eiSos GmbH & Co. KG. All other trademarks, registered trademarks, and product names are the exclusive property of the respective owners.

18.4 Usage restriction

Würth Elektronik eiSos GmbH & Co. KG products have been designed and developed for usage in general electronic equipment only. This product is not authorized for use in equipment where a higher safety standard and reliability standard is especially required or where a failure of the product is reasonably expected to cause severe personal injury or death,

unless the parties have executed an agreement specifically governing such use. Moreover, Würth Elektronik eiSos GmbH & Co. KG products are neither designed nor intended for use in areas such as military, aerospace, aviation, nuclear control, submarine, transportation (automotive control, train control, ship control), transportation signal, disaster prevention, medical, public information network etc. Würth Elektronik eiSos GmbH & Co. KG must be informed about the intent of such usage before the design-in stage. In addition, sufficient reliability evaluation checks for safety must be performed on every electronic component, which is used in electrical circuits that require high safety and reliability function or performance. By using Würth Elektronik eiSos GmbH & Co. KG products, the customer agrees to these terms and conditions.

19 License terms

This License Terms will take effect upon the purchase and usage of the Würth Elektronik eiSos GmbH & Co. KG wireless connectivity products. You hereby agree that this license terms is applicable to the product and the incorporated software, firmware and source codes (collectively, "Software") made available by Würth Elektronik eiSos in any form, including but not limited to binary, executable or source code form.

The software included in any Würth Elektronik eiSos wireless connectivity product is purchased to you on the condition that you accept the terms and conditions of this license terms. You agree to comply with all provisions under this license terms.

19.1 Limited license

Würth Elektronik eiSos hereby grants you a limited, non-exclusive, non-transferable and royalty-free license to use the software and under the conditions that will be set forth in this license terms. You are free to use the provided Software only in connection with one of the products from Würth Elektronik eiSos to the extent described in this license terms. You are entitled to change or alter the source code for the sole purpose of creating an application embedding the Würth Elektronik eiSos wireless connectivity product. The transfer of the source code to third parties is allowed to the sole extent that the source code is used by such third parties in connection with our product or another hardware provided by Würth Elektronik eiSos under strict adherence of this license terms. Würth Elektronik eiSos will not assume any liability for the usage of the incorporated software and the source code. You are not entitled to transfer the source code in any form to third parties without prior written consent of Würth Elektronik eiSos.

You are not allowed to reproduce, translate, reverse engineer, decompile, disassemble or create derivative works of the incorporated Software and the source code in whole or in part. No more extensive rights to use and exploit the products are granted to you.

19.2 Usage and obligations

The responsibility for the applicability and use of the Würth Elektronik eiSos wireless connectivity product with the incorporated Firmware in a particular customer design is always solely within the authority of the customer. Due to this fact, it is up to you to evaluate and investigate, where appropriate, and to decide whether the device with the specific product characteristics described in the product specification is valid and suitable for your respective application or not.

You are responsible for using the Würth Elektronik eiSos wireless connectivity product with the incorporated Firmware in compliance with all applicable product liability and product safety laws. You acknowledge to minimize the risk of loss and harm to individuals and bear the risk for failure leading to personal injury or death due to your usage of the product.

Würth Elektronik eiSos' products with the incorporated Firmware are not authorized for use in safety-critical applications, or where a failure of the product is reasonably expected to cause severe personal injury or death. Moreover, Würth Elektronik eiSos' products with the incorporated Firmware are neither designed nor intended for use in areas such as military, aerospace, aviation, nuclear control, submarine, transportation (automotive control, train control, ship control), transportation signal, disaster prevention, medical, public information network etc. You shall inform Würth Elektronik eiSos about the intent of such usage before design-in stage. In certain customer applications requiring a very high level of safety and in which the malfunction or failure of an electronic component could endanger human life or

health, you must ensure to have all necessary expertise in the safety and regulatory ramifications of your applications. You acknowledge and agree that you are solely responsible for all legal, regulatory and safety-related requirements concerning your products and any use of Würth Elektronik eiSos' products with the incorporated Firmware in such safety-critical applications, notwithstanding any applications-related information or support that may be provided by Würth Elektronik eiSos. YOU SHALL INDEMNIFY WÜRTH ELEKTRONIK EISOS AGAINST ANY DAMAGES ARISING OUT OF THE USE OF WÜRTH ELEKTRONIK EISOS' PRODUCTS WITH THE INCORPORATED FIRMWARE IN SUCH SAFETY-CRITICAL APPLICATIONS.

19.3 Ownership

The incorporated Firmware created by Würth Elektronik eiSos is and will remain the exclusive property of Würth Elektronik eiSos.

19.4 Disclaimer of warranty

THE FIRMWARE IS PROVIDED "AS IS". YOU ACKNOWLEDGE THAT WÜRTH ELEKTRONIK EISOS MAKES NO REPRESENTATIONS AND WARRANTIES OF ANY KIND RELATED TO, BUT NOT LIMITED TO THE NON-INFRINGEMENT OF THIRD PARTIES' INTELLECTUAL PROPERTY RIGHTS OR THE MERCHANTABILITY OR FITNESS FOR YOUR INTENDED PURPOSE OR USAGE. WÜRTH ELEKTRONIK EISOS DOES NOT WARRANT OR REPRESENT THAT ANY LICENSE, EITHER EXPRESS OR IMPLIED, IS GRANTED UNDER ANY PATENT RIGHT, COPYRIGHT, MASK WORK RIGHT, OR OTHER INTELLECTUAL PROPERTY RIGHT RELATING TO ANY COMBINATION, MACHINE, OR PROCESS IN WHICH THE WÜRTH ELEKTRONIK EISOS' PRODUCT WITH THE INCORPORATED FIRMWARE IS USED. INFORMATION PUBLISHED BY WÜRTH ELEKTRONIK EISOS REGARDING THIRD-PARTY PRODUCTS OR SERVICES DOES NOT CONSTITUTE A LICENSE FROM WÜRTH ELEKTRONIK EISOS TO USE SUCH PRODUCTS OR SERVICES OR A WARRANTY OR ENDORSEMENT THEREOF.

19.5 Limitation of liability

Any liability not expressly provided by Würth Elektronik eiSos shall be disclaimed. You agree to hold us harmless from any third-party claims related to your usage of the Würth Elektronik eiSos' products with the incorporated Firmware, software and source code. Würth Elektronik eiSos disclaims any liability for any alteration, development created by you or your customers as well as for any combination with other products.

19.6 Applicable law and jurisdiction

Applicable law to this license terms shall be the laws of the Federal Republic of Germany. Any dispute, claim or controversy arising out of or relating to this license terms shall be resolved and finally settled by the court competent for the location of Würth Elektronik eiSos' registered office.

19.7 Severability clause

If a provision of this license terms is or becomes invalid, unenforceable or null and void, this shall not affect the remaining provisions of the terms. The parties shall replace any such

provisions with new valid provisions that most closely approximate the purpose of the terms.

19.8 Miscellaneous

Würth Elektronik eiSos reserves the right at any time to change this terms at its own discretion. It is your responsibility to check at Würth Elektronik eiSos homepage for any updates. Your continued usage of the products will be deemed as the acceptance of the change.

We recommend you to be updated about the status of new firmware and software, which is available on our website or in our data sheet and manual, and to implement new software in your device where appropriate.

By ordering a wireless connectivity product, you accept this license terms in all terms.

List of Figures

1	Elara-II module	9
2	Block diagram	10
3	Pinout (top view)	18
4	Power up	23
5	Elara-II (Module Start-up)	25
6	Elara-II - Quick start setup (passive antenna)	26
7	Elara-II - Quick start setup (active antenna)	26
8	Host Based Low Power Mode	29
9	Push To Fix	30
10	Push-To-Fix Current Consumption Profile	31
11	Trickle Power Mode Current Consumption Profile	32
12	Footprint Design	34
13	Layout Design	35
14	Stackup	36
15	Placement of the module	37
16	Dimensioning the antenna feed line as micro strip	38
17	GNSS Active antenna	40
18	GNSS multilayer chip antenna	41
19	Reference design: Schematic sheet-1	43
20	Reference design: Schematic sheet-2	44
21	Reference design: Schematic sheet-3	45
22	Reference design: Layout	46
23	Interface Selection for SPI	47
24	UART host interface	49
25	I ² C host interface	50
26	Flowchart for host implementation	53
27	SPI interface	54
28	SPI Mode 1 (CPHA=1, CPOL=0)	54
29	Flowchart Read for SPI Master implementation	58
30	Flowchart Write for SPI Master implementation	59
31	NMEA Standard Sentences for Elara-II	61
32	NMEA Product-Specific Sentences for SiRFStar V	62
33	Example of 1 Hz navigation	75
34	Example of 5 Hz navigation	75
35	OSP Sentences for Elara-II	78
36	Reflow soldering profile	98
37	Module dimensions [mm]	102
38	Footprint and dimensions [mm]	103
39	Lot number structure	104

List of Tables

1	Ordering information	10
2	Recommended operating conditions	11
3	Absolute maximum ratings	11
4	Current consumption	12
5	Antenna connector Type	13
6	Radio characteristics	13

7	Pin characteristics	13
8	GNSS constellations supported	14
9	Additional systems supported	14
10	Horizontal Position Accuracy	15
11	Vertical Position Accuracy	15
12	Velocity Accuracy	15
13	Heading Accuracy	15
14	Time Accuracy	16
15	Time To First Fix	16
16	Sensitivity	17
17	Dynamic Constraints	17
18	Pinout	18
19	Pinout - UART communication	19
20	Pinout - I ² C Multi Master communication	19
21	Pinout - SPI slave communication	19
22	ON_OFF pin function	19
23	WAKE_UP pin function	20
24	Minimal pin configuration, UART mode	22
25	Startup timing	23
26	Module Mode of Operation	25
27	PVT data	27
28	Communication Settings	27
29	Cold, Warm and Hot Start	28
30	2600130016 - antenna specifications	40
31	7488920157 - antenna specifications	41
32	Interface selection	48
33	UART properties	49
34	I ² C properties	50
35	SPI properties of GNSS module	55
36	Communication Protocol	60
37	NMEA Standard Sentences: Talker ID	61
38	NMEA Standard Sentences: Data format	61
39	Message overview	63
40	GGA Data Format	64
41	GLL Data Format	65
42	GNS Data Format	66
43	GSA Data Format	67
44	GSV Data Format	68
45	RMC Data Format	69
46	VTG Data Format	70
47	ZDA Data Format	71
48	Estimated Position Error	72
49	Ok To Send	72
50	Response to Poll SW version	73
51	Message rate selection	74
52	Baud rate selection	76
53	Response to Poll SW version	76
54	Navigation initialization	77
55	Data types	79
56	Message overview for OSP messages	80
57	MID 67,1 - Multiconstellation Navigation Data	82

58	MID 67,16 - Multiconstellation Satellite Data	83
59	MID 67,16 - Satellite information	84
60	MID 2 - Measure Navigation Data Indication	85
61	Satellite PRN mapping	85
62	MID 51,1 - Navigation Cycle Complete	86
63	MID 6 - SW Version	86
64	MID 18 - Ok To Send	87
65	MID 11 - Command Acknowledgment Response	87
66	MID 12 - Command Negative Acknowledgment Response	87
67	MID 129 - Switch NMEA protocol request	88
68	MID 134 - Baud rate selection	89
69	MID 132 - SW version request	89
70	MID 222,16 - Location Technology Constraints Request	90
71	MID 128 - Initialize Data Source Request	91
72	MID 136 - Mode control	92
73	MID 218,6 - Low Power Mode Request	93
74	Default ROM Settings	95
75	Classification reflow soldering profile, Note: refer to IPC/JEDEC J-STD-020E	96
76	Package classification reflow temperature, PB-free assembly, Note: refer to IPC/JEDEC J-STD-020E	97
77	Dimensions	101
78	Weight	101
79	Lot number details	104



more than you expect



**Internet
of Things**



**Monitoring
& Control**



**Automated Meter
Reading**

Contact:

Würth Elektronik eiSos GmbH & Co. KG
Division Wireless Connectivity & Sensors

Max-Eyth-Straße 1
74638 Waldenburg
Germany

Tel.: +49 651 99355-0

Fax.: +49 651 99355-69

www.we-online.com/wireless-connectivity

