

UK +44 (0)151 220 2500 // USA +1 855 958 2502 //
www.brainboxes.com // sales@brainboxes.com

US-842

8 Port RS422/485 USB to Serial Adapter

- High retention USB socket for an unshakeable connection
- Includes 1m / approx. 3ft USB Type A to B cable
- Drivers for all popular operating systems
- IP-30 rated non-conducting case

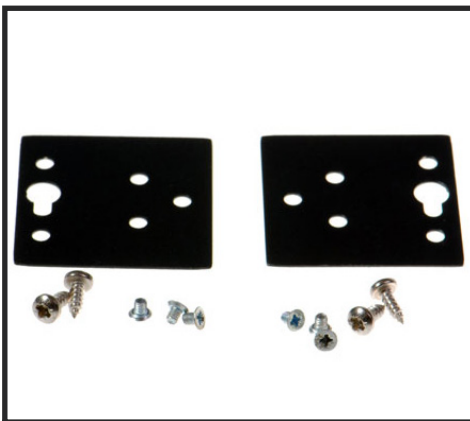
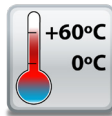

Wall Mounting Kit available - MK-059

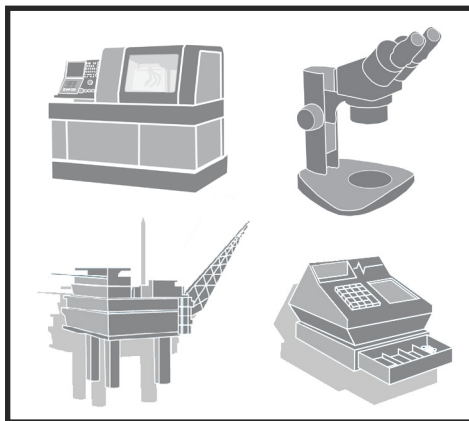

Example applications:

CNC Machine
Laboratory
Oil Rig
Point of Sale



High retention USB connection requires a minimum withdrawal requirement of 15N (thats a force of 1.5Kg or 3.4lbs)



UK +44 (0)151 220 2500 // USA +1 855 958 2502 //
www.brainboxes.com // sales@brainboxes.com

US-842 8 Port RS422/485 USB to Serial Adapter

Plug and play with signed drivers

Orange color-coded insulator to differentiate from standard USB connectors

High retention USB connector for an unshakeable connection



IP-30 rated non-conducting case



USB connection requires a minimum withdrawal requirement of 15N

Works across the full spectrum of baud rates up to 921,600 including standard and arbitrary values

LED Information

Status LED	Green Power	On
Serial Port LEDs	Green Light On	Data TX
	Green Light On	Data RX

Power Input	5V DC input
Power Consumption	1A @ 5V

Port	
Connector	DB9 Connector - 9 Pin Male connector (9 Pin Male)
FIFO Size	384 RX FIFO + 128 TX FIFO
Operating Distance	EIA - RS422/485 Standard
Cable	USB cable Type A to B 1 metre / approx. 3ft

Port Settings - RS422/485

Baud Rate	300 to 921,600 baud
Data Bits	7 or 8
Parity	Odd, Even, None, Mark or Space
Stop Bits	1 or 2
Flow Control	RTS/CTS, DSR/DTR, XON/XOFF
Tx/Rx Modes	Point to Point

US-842 8 Port RS422/485 USB to Serial Adapter

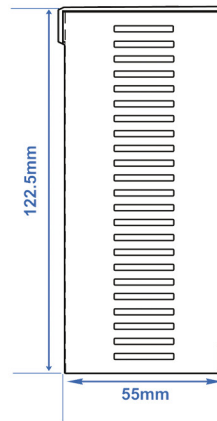
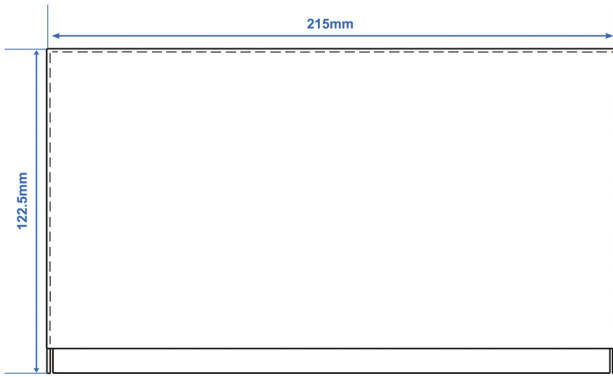

RS422/485

Pin 1	TXD-
Pin 2	TXD+
Pin 3	RTS-
Pin 4	RTS+
Pin 5	GND
Pin 6	RXD-
Pin 7	RXD+
Pin 8	CTS
Pin 9	CTS+

RS422/485 Pinout (9 Pin)

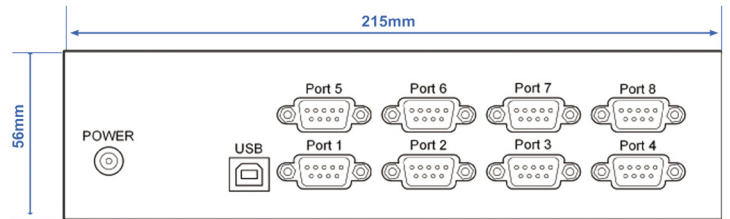
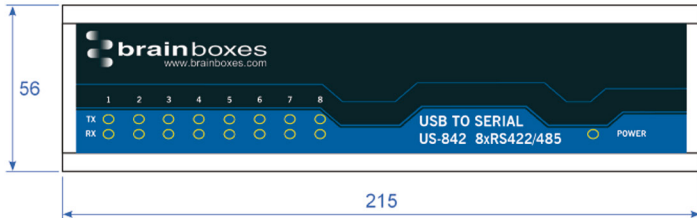
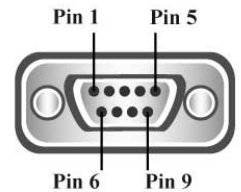

Software

OS Compatibility

Brainboxes' software provides a Serial COM port interface. All software versions and updates available to download from our website.

Microsoft

Windows 8, Windows 8.1, Windows 10
Windows Server 2016
Windows Server 2019



Lifetime Warranty and Support:

We can help with every aspect of your project, from getting you up and running to custom application.

UK +44 (0)151 220 2500 // USA +1 855 958 2502 //
www.brainboxes.com // sales@brainboxes.com

US-842 8 Port RS422/485 USB to Serial Adapter

Packaging Information	QSG, Device, 1.8m / 70.1in USB Type A to B cable (signed drivers are automatically downloaded by Windows OS)
Product Weight	0.881 kg, 31.08 ounces
Product Dims	215x123x56 mm, 8.5x4.8x2.2 inches
Packaged Weight	1.206 kg, 42.54 ounces
Packaged Dims	300x135x80 mm, 11.8x5.3x3.1 inches
GTIN Universal Code	837324002133
Industry Approvals	Microsoft Certified Gold Partner, WEEE, RoHS, AEO (C-TPAT), CE, UKCA, UL
HTS	8471800000
ECCN	4A994
CAGE	8QCY6
Warranty	Lifetime - online registration required
Support	Lifetime Web, Email & Phone Support from fully qualified, friendly staff who work in and alongside the Product Development Team
Standards	ISO9001, ISO14001
OEM option	Available for bulk buy OEM
Customisable	Brainboxes operate a 'Perfect Fit Custom Design' policy for volume users More info:sales@brainboxes.com

USB to Serial Range

USB to Serial adaptors available in a range of formats and specifications

www.brainboxes.com



US-101

USB 1 Port RS232 1MBaud



US-159

Ultra 1 Port RS232 Isolated
USB to Serial Adapter



US-235

Ultra 1 Port RS232 USB to
Serial Adapter