



SPECIFICATIONS

Model	Stroke mm	Max Energy Absorption J(kgf·m)	Max Equiv. Mass kg(kgf)	Range of Impact Rate m/s	Orifice Type
FA-3650UD-S	50	392(40)	1400(1400)	0.7~3	Single-orifice type

COMMON SPECIFICATIONS

Max Drag N(kgf)	Max Cycle Rate cycle/min	Max Energy Absorption per min. J/min(kgf·m/min)	Extension Force N(kgf)	Operating Temp. C°	Mass g
23520(2400)	30	2352(240)	68.6(7.0) or lower	-5~70	1330

PRECAUTIONS FOR USE

- Do not use this product without carefully reading the attached owner's manual.
- Ensure that an external stopper (Stopper nut OP-020UB) is also used.
- Do not turn the oil inlet screw located at the bottom of the main unit.
- Ensure that sufficient mounting strength is secured for this product. (As a guideline, it should be 2 to 3 times the maximum drag listed in the catalogue.)
- Do not use this product in a vacuum or a location where it may come in contact with oil.
- Ensure that an eccentric load is not applied to the soft absorber. (Allowable eccentric angle: within $\pm 2.5^\circ$)

ADJUSTMENT METHOD

- To adjust, turn the adjustment knob located at the bottom of the main unit.
- Because the adjustment can be done in an analog manner, a value between two integers on the indicator can be set.
- Once the adjustment is complete, secure with a lock screw using a hex wrench.

ABSORPTION CHARACTERISTICS

Orifice type	Multiple-orifice type	<p>Absorption characteristics</p>
Model number	FA-3650UD Series	
Application	For high speed	

OPTIONAL PARTS

Eccentric angle adaptor OP-010UB

- Screw the eccentric angle adaptor into the main unit until the cap for the eccentric angle and the piston rod form a tight connection. While maintaining this position, fasten the main unit's nut until it is secured.
- Use the eccentric angle adaptor when the eccentric angle is 2.5° or larger.
- The main unit can also be used as a stopper.
- Use it with a capless soft absorber.
- The maximum operating eccentric angle with an eccentric angle adaptor is $\pm 10^\circ$.
- The caps and the guides for inclined use are not unbundled.

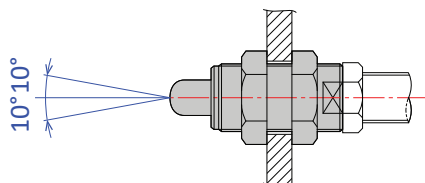
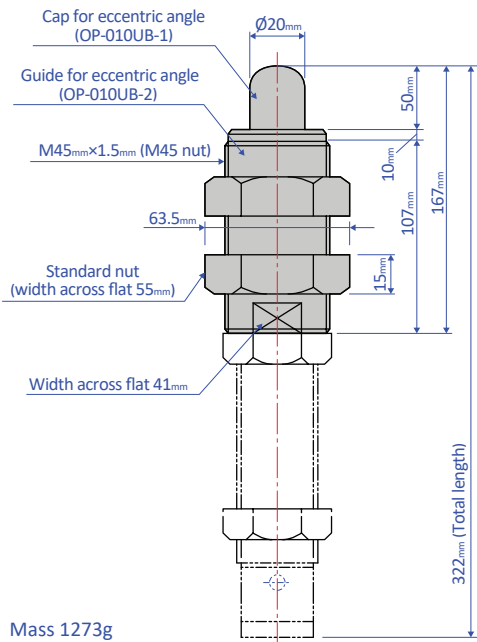

Note: Material of cap for eccentric angle: Metal

Stopper nut OP-020UB

- Adjust so that it stops 1 mm before the stroke end, and fasten with the main unit's nut until secured.

OP-020UB-S
(without cap)

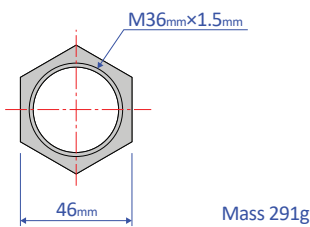
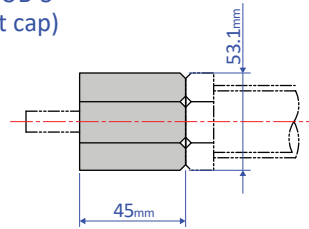

OP-020UB-C
(with cap)

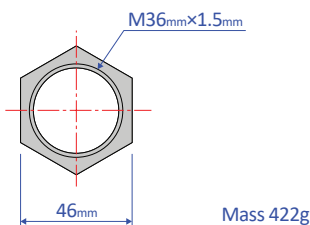
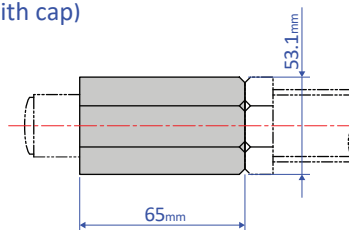

Note: When attaching, make sure that the side without a bearing chamfer is the impact surface.

Standard nuts are sold separately as well - M36 Nut

Square flange OP-040UB

- Once the attachment site is determined, use the main unit's nut to securely fasten in place.

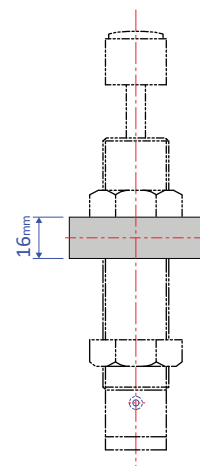
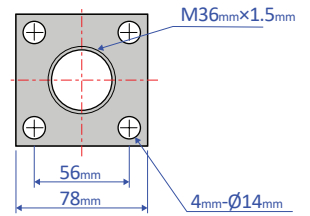

Mass 566g