

User Manual

# HIT-W151

## Healthcare Infotainment Terminal

**ADVANTECH**

*Enabling an Intelligent Planet*

## Copyright

The documentation and the software included with this product are copyrighted 2011 by Advantech Co., Ltd. All rights are reserved. Advantech Co., Ltd. reserves the right to make improvements in the products described in this manual at any time without notice. No part of this manual may be reproduced, copied, translated or transmitted in any form or by any means without the prior written permission of Advantech Co., Ltd. Information provided in this manual is intended to be accurate and reliable. However, Advantech Co., Ltd. assumes no responsibility for its use, nor for any infringements of the rights of third parties, which may result from its use.

## Acknowledgements

Intel and Pentium are trademarks of Intel Corporation.

Microsoft Windows and MS-DOS are registered trademarks of Microsoft Corp.

All other product names or trademarks are properties of their respective owners.

## Declaration of Conformity

### FCC Class B

Note: This equipment has been tested and found to comply with the limits for a Class B digital device, pursuant to part 15 of the FCC Rules. These limits are designed to provide reasonable protection against harmful interference in a residential installation. This equipment generates, uses and can radiate radio frequency energy and, if not installed and used in accordance with the instructions, may cause harmful interference to radio communications. However, there is no guarantee that interference will not occur in a particular installation. If this equipment does cause harmful interference to radio or television reception, which can be determined by turning the equipment off and on, the user is encouraged to try to correct the interference by one or more of the following measures:

- Reorient or relocate the receiving antenna.
- Increase the separation between the equipment and receiver.
- Connect the equipment into an outlet on a circuit different from that to which the receiver is connected.
- Consult the dealer or an experienced radio/TV technician for help.

**Warning!** *Any changes or modifications made to the equipment which are not expressly approved by the relevant standards authority could void your authority to operate the equipment.*



**Caution!** *Danger of explosion if battery is incorrectly replaced. Replace only with the same or equivalent type recommended by the manufacturer. Dispose of used batteries according to the manufacturer's instructions.*



## Technical Support and Assistance

1. Visit the Advantech web site at [www.advantech.com/support](http://www.advantech.com/support) where you can find the latest information about the product.
2. Contact your distributor, sales representative, or Advantech's customer service center for technical support if you need additional assistance. Please have the following information ready before you call:
  - Product name and serial number
  - Description of your peripheral attachments
  - Description of your software (operating system, version, application software, etc)
  - A complete description of the problem
  - The exact wording of any error messages

**Warning!** 1. *Input voltage is rated 19 V<sub>DC</sub>, 3 A (DC Mode).*



2. *Packing: Please carry the unit with both hands; handle with care.*
3. *Maintenance: To properly maintain and clean the surfaces, use only approved products or clean with a dry applicator.*

## Safety Instructions

1. Read these safety instructions carefully.
2. Keep this User Manual for later reference.
3. Disconnect this equipment from any AC outlet before cleaning. Use a damp cloth. Do not use liquid or spray detergents for cleaning.
4. For plug-in equipment, the power outlet socket must be located near the equipment and must be easily accessible.
5. Keep this equipment away from humidity.
6. Put this equipment on a reliable surface during installation. Dropping it or letting it fall may cause damage.
7. The openings on the enclosure are for air convection. Protect the equipment from overheating. **DO NOT COVER THE OPENINGS.**
8. Make sure the voltage of the power source is correct before connecting the equipment to the power outlet.
9. Position the power cord so that people cannot step on it. Do not place anything over the power cord.
10. All cautions and warnings on the equipment should be noted.
11. If the equipment is not used for a long time, disconnect it from the power source to avoid damage by transient overvoltage.
12. Never pour any liquid into an opening. This may cause fire or electrical shock.
13. Never open the equipment. For safety reasons, the equipment should be opened only by qualified service personnel.
14. If one of the following situations arises, get the equipment checked by service personnel:
  - a. The power cord or plug is damaged.
  - b. Liquid has penetrated the equipment.
  - c. The equipment has been exposed to moisture.
  - d. The equipment does not work well, or you cannot get it to work according to the user's manual.
  - e. The equipment has been dropped and damaged.
  - f. The equipment has obvious signs of breakage.
15. **DO NOT LEAVE THIS EQUIPMENT IN AN ENVIRONMENT WHERE THE STORAGE TEMPERATURE MAY GO BELOW -20° C (-4° F) OR ABOVE 60° C (140° F). THIS COULD DAMAGE THE EQUIPMENT. THE EQUIPMENT SHOULD BE IN A CONTROLLED ENVIRONMENT.**
16. If your computer clock loses a significant amount of time or the BIOS configuration resets to default, the battery has no power.

**Caution!** 1. *Do not replace power adaptor yourself. Please contact a qualified technician or your retail.*



2. *The computer is provided with a battery-powered real-time clock circuit. There is a danger of explosion if battery is incorrectly replaced. Replace only with same or equivalent type recommended by the manufacturer. Discard used batteries according to the manufacturer's instructions*
3. *Cleaning: During normal use of the HIT-W151 may become soiled and should, therefore, be cleaned regularly. Agents: Alcohol or water.*
4. *End of Product: for Environmental protection, please follow national requirements to dispose of unit.*

17. CLASSIFICATION:
  - Supplied by Class I adapter
  - No applied parts
  - Continuous operation
  - No AP or APG category
18. Follow national requirements to dispose of unit.
19. Maintenance: To properly maintain and clean the surfaces, use only approved products or clean with a dry cloth.
20. Contact information:  
No.1, Alley 20, Lane 26, Rueiguang Road Neihu District, Taipei, Taiwan 114, R.O.C  
TEL: (02) 2792-7818
- 21.



**Medical Equipment**  
With Respect to Electric Shock,  
Fire, and Mechanical Hazards Only,  
In Accordance with UL 60601-1,  
CAN/CSA C22.2 No. 601.1

22. This equipment is not to be used as a life support system.
23. Accessory equipment connected to the analog and digital interfaces must be in compliance with the respective nationally harmonized IEC standards (i.e. IEC 60950 for data processing equipment, IEC 60065 for video equipment, IEC 61010-1 for laboratory equipment, and IEC 60601-1 for medical equipment.) Furthermore all configurations must comply with the system standard IEC 60601-1-1. Anyone who connects additional equipment to the signal input part or signal output part is configuring a medical system, and is therefore, responsible that the system complies with the requirements of the system standard IEC 60601-1-1. The unit is for exclusive interconnection with IEC 60601-1 certified equipment in the patient environment and IEC 60XXX certified equipment outside of the patient environment. If in doubt, consult the technical services department or your local representative.
24. A user must not allow SIP/SOPs and the patient to come into contact with one another at the same time.
25. The sound pressure level at the operator's position according to IEC 704-1:1982 is no more than 70dB (A).

DISCLAIMER: This set of instructions is given according to IEC 704-1. Advantech disclaims all responsibility for the accuracy of any statements contained herein.

**Note!** *Attention, please thoroughly consult the accompanying documentation.*



**Caution!** *This product: HIT-W151 is only used with the qualified & certificated power adapter listed below:*



*Medical: SINPRO ELECTRONICS CO LTD, model: MPU50-107, Output: 16-21Vdc, 50W max (SET UP19Vdc, 2.63A).*

*ITE: FSP GROUP INC, model: FSP090-DMBB1, Output: 19Vdc, 4.74A Max (90W max).*



# Contents

<b>Chapter 1</b>	<b>Introduction.....</b>	<b>1</b>
1.1	Overview .....	2
1.2	System Configuration.....	3
<b>Chapter 2</b>	<b>Hardware Description .....</b>	<b>5</b>
2.1	General Specifications .....	6
2.2	Mechanical Specifications.....	7
2.2.1	Mechanical Specifications (Terminal) .....	7
2.2.2	Mechanical Drawing for Rear I/O .....	8
2.3	External View .....	8
2.3.1	Front View.....	8
2.3.2	Side & Bottom View .....	9
2.3.3	Rear View .....	9
<b>Chapter 3</b>	<b>Software Description.....</b>	<b>11</b>
3.1	Windows XP Embedded Software Specifications .....	12
<b>Chapter 4</b>	<b>Design Requirements.....</b>	<b>15</b>
4.1	Environmental Specifications .....	16
4.2	Reliability.....	16
<b>Chapter 5</b>	<b>Installation.....</b>	<b>17</b>
5.1	Installation for Terminal.....	18
5.2	Installation for Handset (For PIT Series Only) .....	19
5.3	Installation for Remote Controller (For PIT Series Only).....	20
5.4	Installation for Arm .....	21





# Chapter 1

## Introduction

This chapter briefly introduces the HIT-W151 product.

- Overview
- System Configuration

## 1.1 Overview

The HIT-W151 Healthcare Infotainment Terminal is a standard Advantech product with built-in Windows XP Embedded OS. In addition to providing hospital bedside patient information, remote monitoring, and care functions, the CPU and the LAN-enabled architecture of the HIT-W151 terminal also serves as an integrated hospital gateway device. The HIT-W151 is equipped with an Intel Atom 1.6GHz Dual-core processor, 15.6" wide, full-flat touchscreen, onboard dual Giga-LAN port, and audio. It plays a key role as a hospital bedside care and monitoring solution, and connects service calls and LED light signals of a hospital room through the LAN to other parts of the hospital.

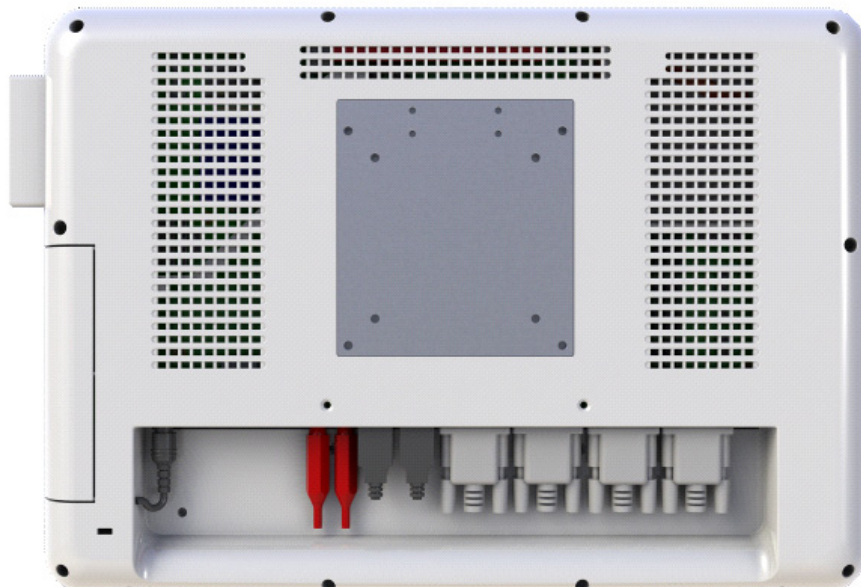

## 1.2 System Configuration

The block diagram of a HIT-W151 Healthcare Infotainment Terminal based on Hospital bedside environment is shown in the following diagram:

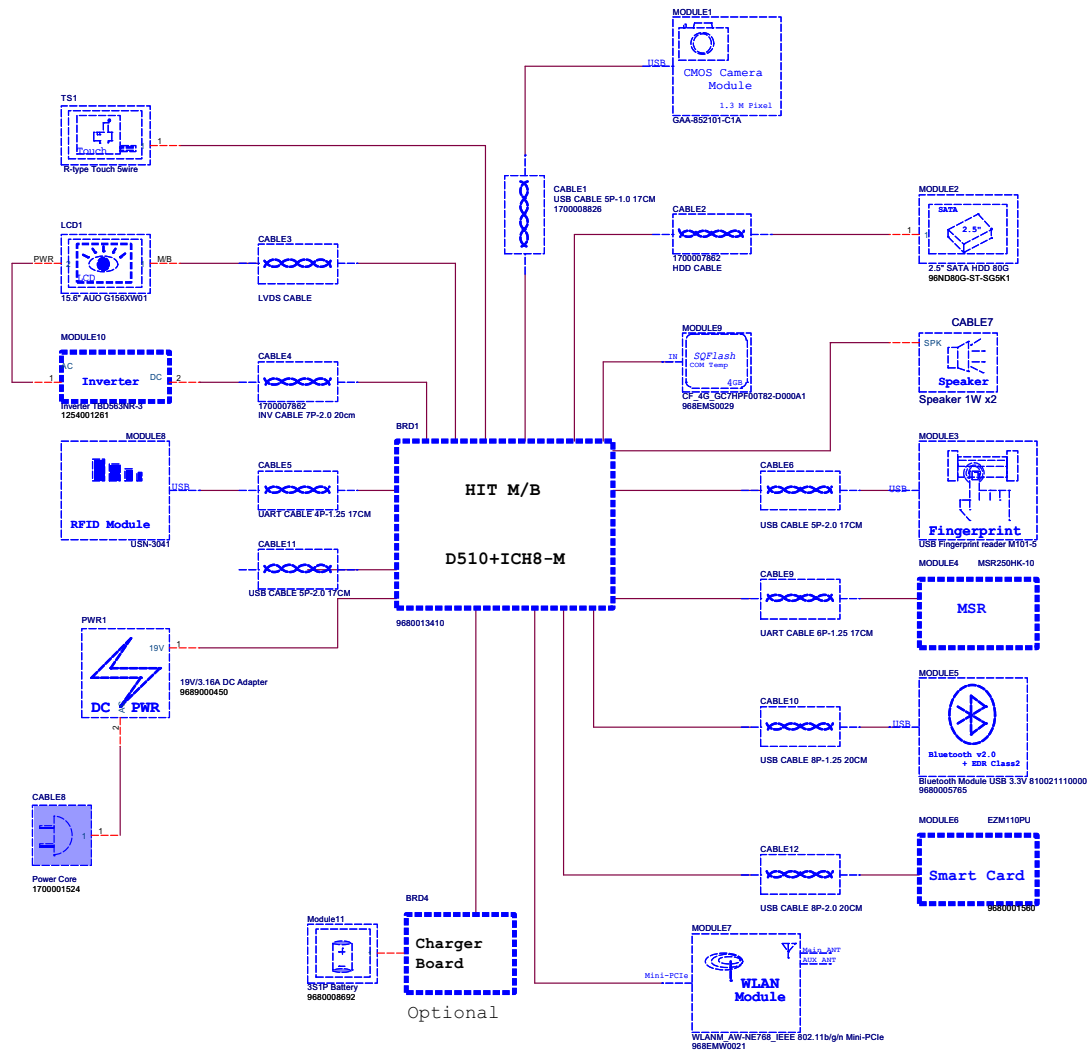



# Chapter 2

## Hardware Description

This Chapter describes the hardware features of the HIT-W151.

- General Specifications
- Mechanical Specifications
- External View

## 2.1 General Specifications

<b>Processor System</b>	CPU	Intel® Atom D510 Dual Core 1.67 GHz Processor	
	Chipset	Intel N450/D510 + ICH8M	
	L2 Cache	512 KB/1 MB	
	FSB Speed	667 MHz	
	Memory	DDR2 200-pin SODIMM x 2	
	SSD	Supports 1 x internal CompactFlash	
	3-in-1 Card Reader	Supports MS & SD & MMC	
	Webcam	Standard, built-in, 2M CMOS camera	
	HDD	1 x 2.5 internal SATA HDD interface	
	Network	2 x Gigabit Ethernet Ports	
	I/O Ports	2 x COM ports, VGA port, GPIO, Mic-in, Line-out	
		4 x USB 2.0 ports	
		2 x Gigabit Ethernet Ports	
	Stereo Speaker	1 W x 2	
	Bus Expansion	MINI PCIe	
Dimensions (W x H x D)	400 mm (W) x 285 mm c 50.3 mm (D) (15.8 x 11.26 x 1.98)		
Weight	5 kg (11 lb.)		
<b>Environmental Specifications</b>	Operating Temperature	0 - 40 °C	
	Relative Humidity	10 - 95% @ 40 °C non-condensing	
	Operating Humidity	20% to 90% (No Condensation)	
	Operating Atmospheric Pressure	700 - 1060 hPa	
	Storage Humidity	10% - 95% (No Condensation)	
	Storage Atmospheric Pressure	700 - 1060 hPa	
	Transportation Temperature	-20 - 60°C	
	Transportation Humidity	10% - 95% (No Condensing)	
	Transportation Atmospheric Pressure	700 - 1060 hPa	
	Vibration	1 G	
	Shock	10 G peak acceleration (11 msec, duration)	
	EMC	BSMI, CE, FCC	
	Safety	CB, CE, UL, CCC, BSMI	
	<b>Power</b>	Output Rating	12-24 V
<b>LCD Display</b>	Size/Type	15.6" TFT LCD	
	Max. Resolution	1366 x 768	
	Max. Color	262 K	
	Pixel Pitch (mm)	248.25 (H) x 248.25 (V)	
	Brightness (cd/m <sup>2</sup> )	300	
	View Angle	170°/160°	
	Backlight MTBF	50,000 hrs	

Touch Screen	Type	Analog Resistive 5-Wire (Touch window)
	Resolutions	Continuous
	Light Transmission	80%
	Controller	USB
	Storage Driver	Windows XP/7/XPE/Linux
	Durability (Touches)	10 million

## 2.2 Mechanical Specifications

### 2.2.1 Mechanical Specifications (Terminal)

- **System Dimensions:** 400 (W) x 285 (H) x 50.8 (D) mm

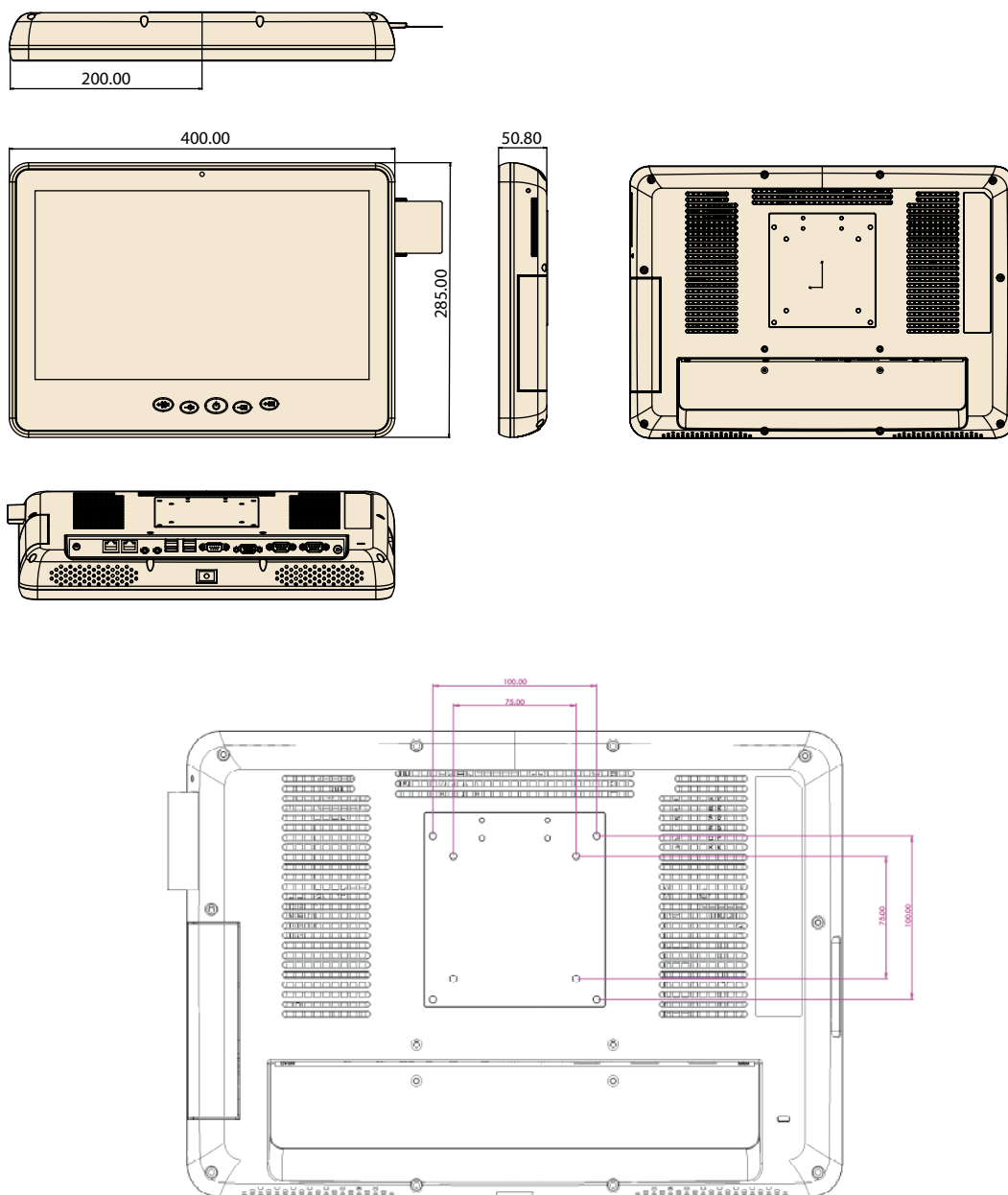

- **Carton Dimensions:** 620 (W) x 540 (H) x 180 (D) (excludes accessories box)
- **Mounting System:** Back box for wall mounting
- **Gross Weight:** 5.0 kg

- **Net Weight:** 3.7 kg
- **VESA Mount:** 75\*75 mm or 100\*100 mm
- **Screws:** M4\*10 mm
- **IPX0**

## 2.2.2 Mechanical Drawing for Rear I/O

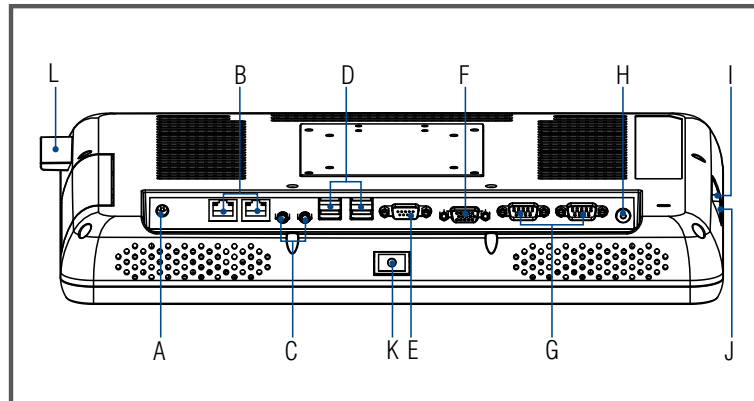

- |   |   |
|---|---|
| A. DC Inlet                               | H. Power Switch                           |
| B. Gigabit LAN x 2                        | I. USB port                               |
| C. Audio Jack (Right: Line-in, Left: MIC) | J. 3-in -1 Memory card reader (MS&SD&MMC) |
| D. USB 2.0 x 4                            | K. Barcode Scanner (optional)             |
| E. GPIO x 1                               | L. Smart Card Reader (optional)           |
| F. VGA x 1                                |   |
| G. COM x 2                                |   |

## 2.3 External View

### 2.3.1 Front View

Front View (Terminal)





## 2.3.2 Side & Bottom View



## 2.3.3 Rear View

### Rear View (Terminal)

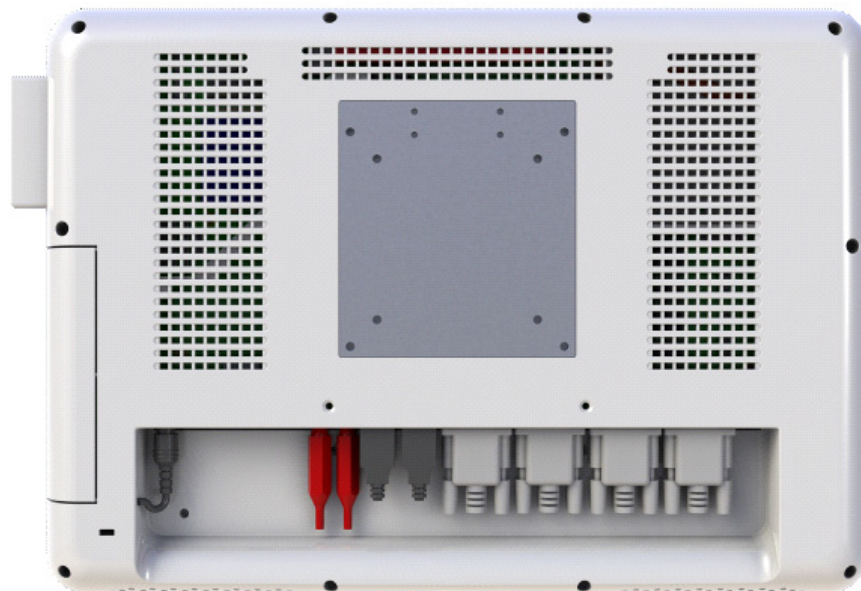



# Chapter 3

## Software Description

This Chapter describes the software features of the HIT-W151.

- Windows XP Embedded Software Specifications

## 3.1 Windows XP Embedded Software Specifications

### Real-Time OS Kernel

- Windows XPE 7 Language Version

### Driver List

■ Chipset	Intel ICH8M	Rev:
■ Graphics	Intel GMA500	Rev:
■ Audio	Realtek Audio ALC880	Rev: 5.10.0.5512
■ LAN	Marvell Yukon Ethernet Controller	Rev: 8.61.7.3
■ Camera	D-Max UVC 1.3M Webcam	Rev: 6.11.200.4
■ Smartcard Reader	ALCOR micro USB smartcard reader	Rev: 5.11.9520.7
■ Touch	Elo TouchSys. 2216 AccuTouch@USB	Rev: 4.4.0.0
■ WLAN	SParkLan WIFI module	Rev:1.2.3.0

### Embedded Application Software

- Advantech SUSI

SUSI Demo Program



## 1. LED Indicator Control.



## 2. LCD Panel Brightness Control.

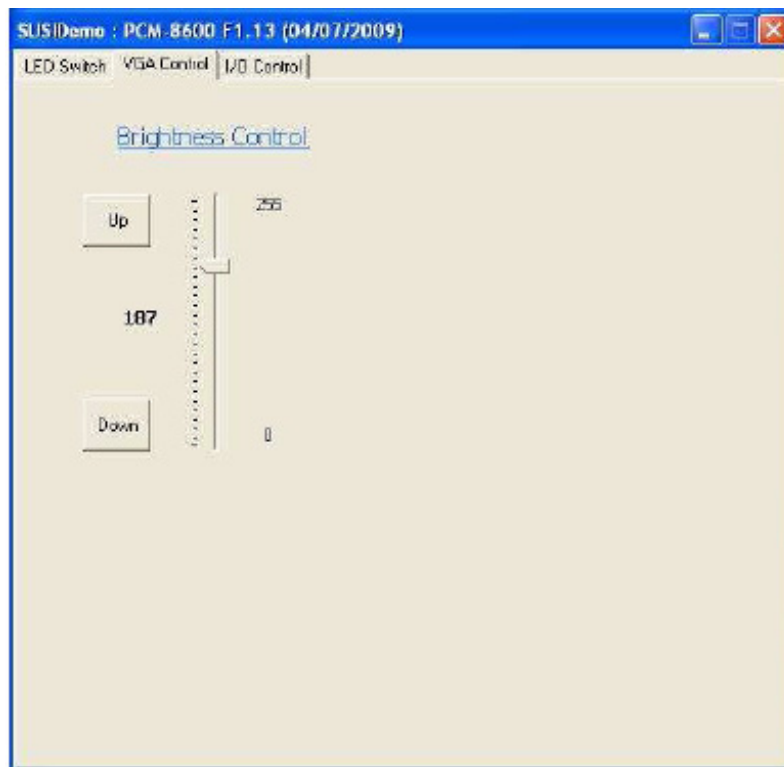



# Chapter 4

## Design Requirements

This Chapter describes the design requirements of the HIT-W151.

- Environmental Specifications
- Reliability

---

## 4.1 Environmental Specifications

### Temperature & Humidity

- Operating temperature: 0 ~ 40° C
- Storage temperature: 0 ~ 60° C
- Relative humidity: 0 ~ 95% RH (Non-condensed)

### Case / Panel Temperature

- Less than 40° C @ 25° C ambient temperature (front bezel)

### Safety

- CE

### EMI

- FCC class B approved

### Vibration:

- 10 ~ 18 Hz, 1.5 mm peak-to-peak displacement
- 18 ~ 500 Hz, 1 G acceleration

## 4.2 Reliability

### MTBF

- 20,000 hours

### Touchscreen

- 1 million touch actuation times on a single point with a 5/8" diameter silicon finger under a 350 g load at 2 Hz

### Power Requirements

- DC Input Voltage: 19 V
- Power Consumption: less than 60 W



# Chapter 5

## Installation

This Chapter describes the installation of the HIT-W151.

- Installation for Terminal
- Installation for Handset (For PIT Series Only)
- Installation for Remote Controller (For PIT Series Only)
- Installation for Arm

## 5.1 Installation for Terminal

Step 1. Fix Hook.

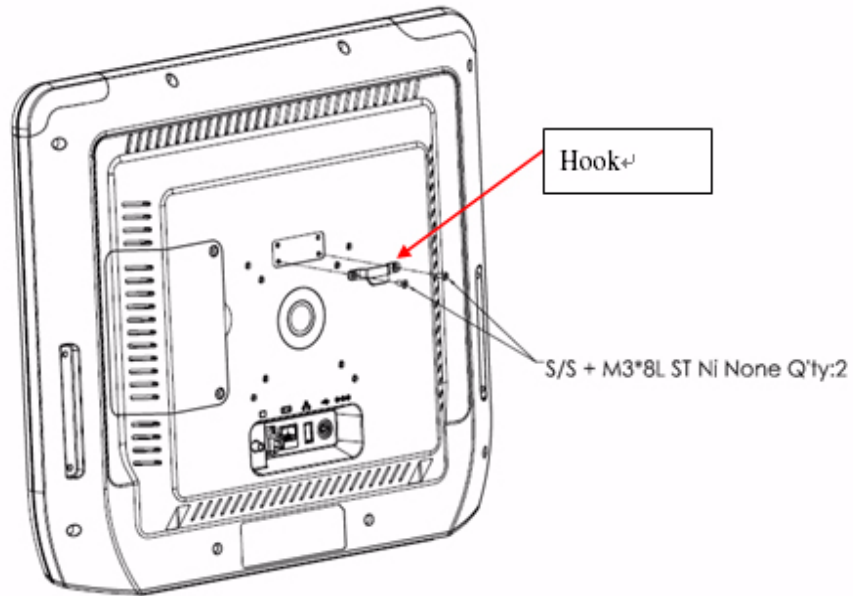

Step 2. Fix ARM + Handset Bracket (for PIT Series only) + Remote Control Bracket (for PIT Series only).

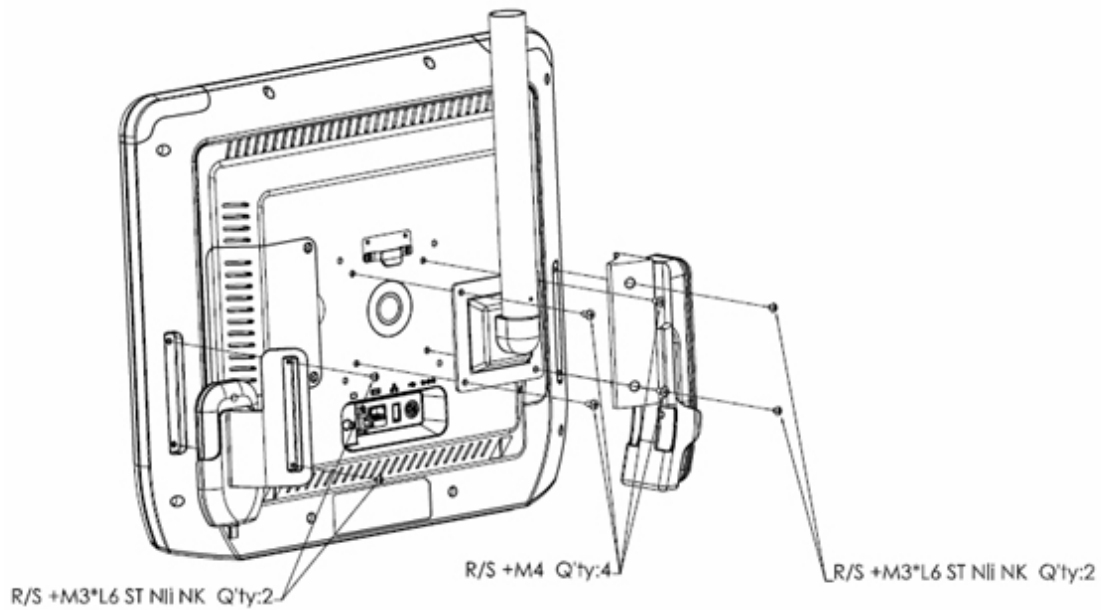

## 5.2 Installation for Handset (For PIT Series Only)

Step 1. Fix Hook.

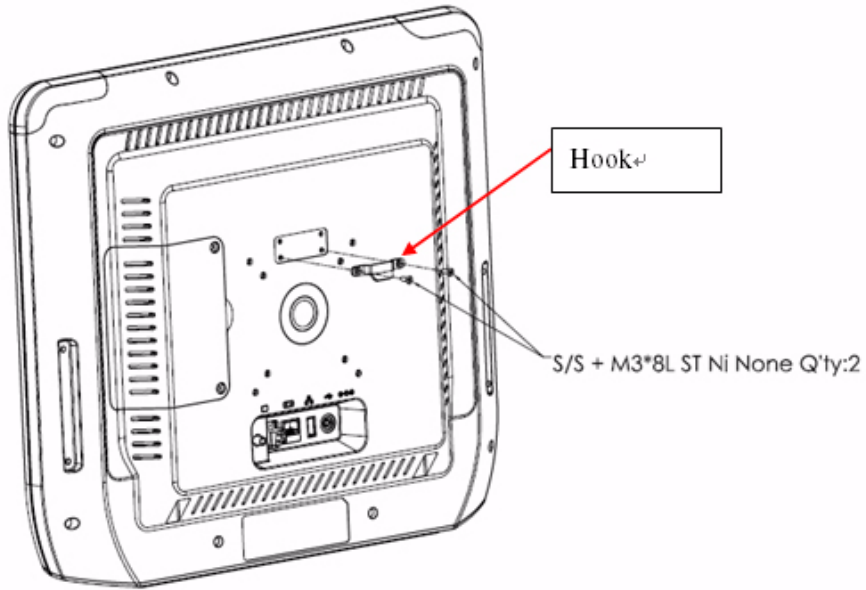

Step 2. Fix ARM + Handset Bracket (for PIT Series only) + Handset (for PIT Series only).

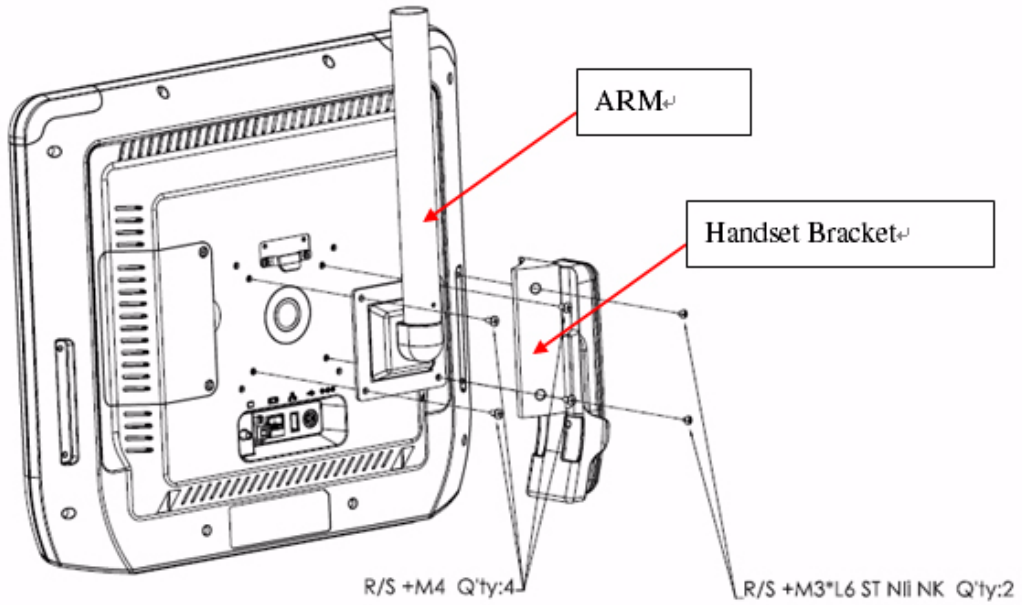

## 5.3 Installation for Remote Controller (For PIT Series Only)

Step 1. Fix Hook.

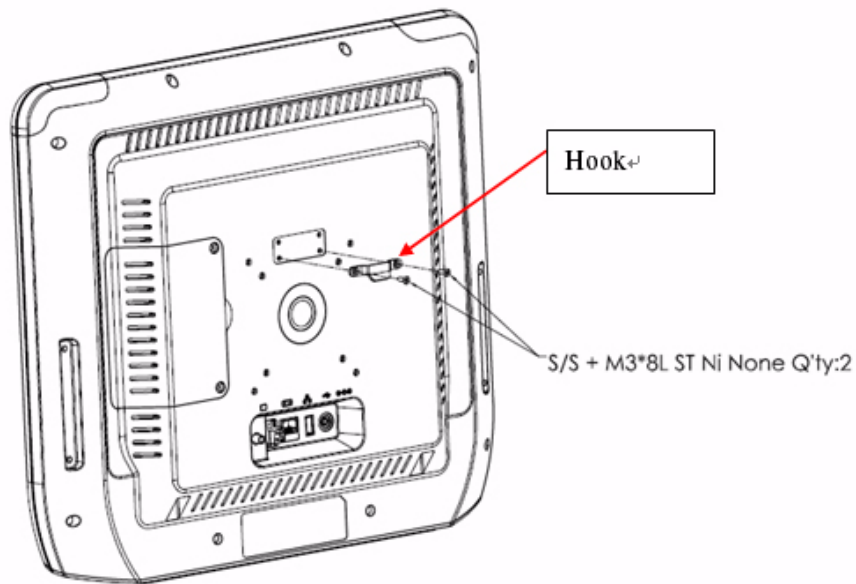

Step 2. Fix ARM + Handset Bracket (for PIT Series only) + Remote Control Bracket (for PIT Series only).

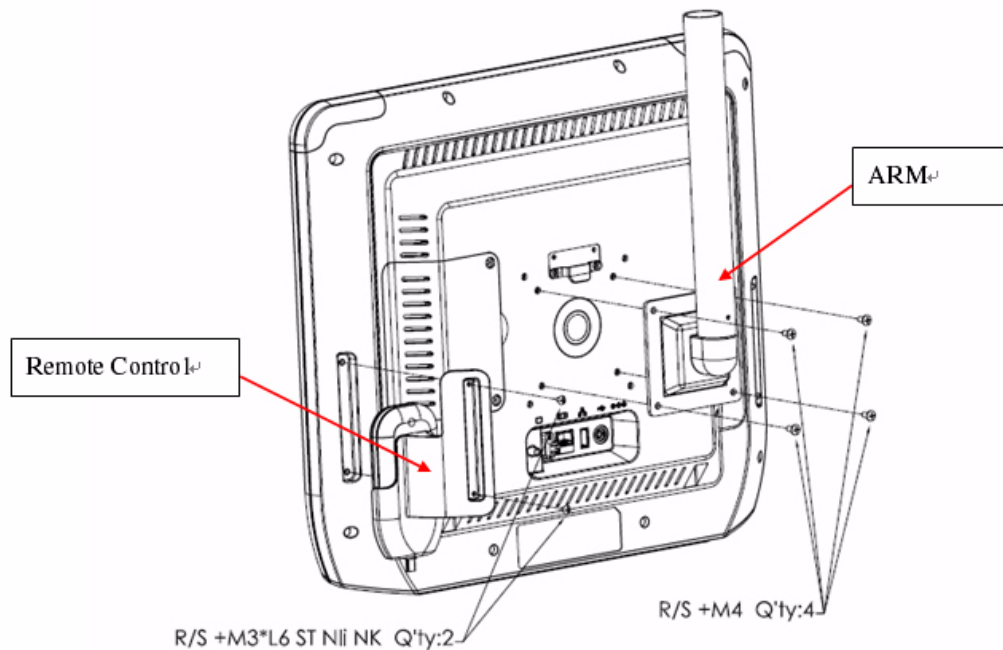

## 5.4 Installation for Arm

Step 1. Fix Hook.

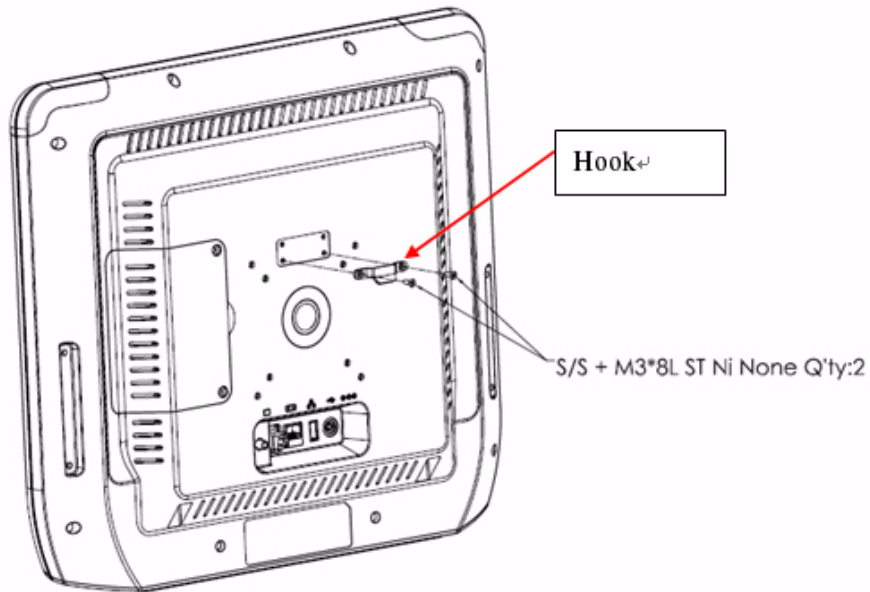

Step 2. Fix ARM + Handset Bracket (for PIT Series only) + Handset (for PIT Series only).

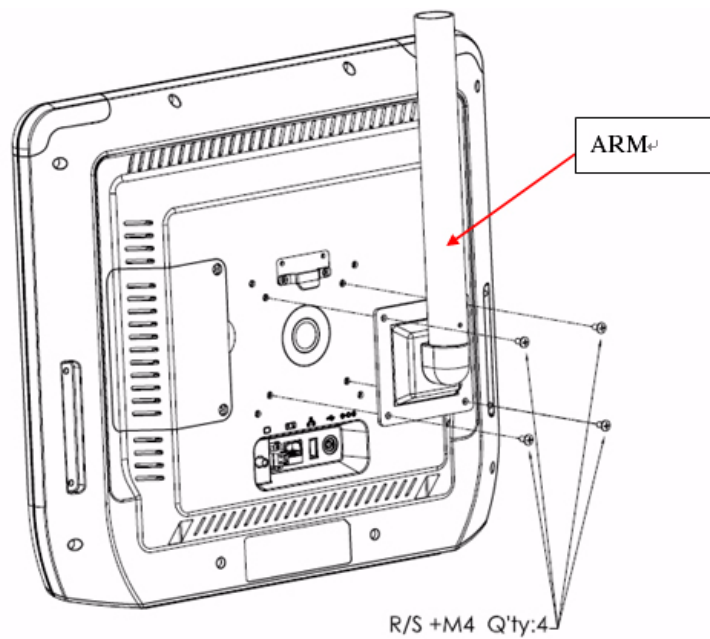

**ADVANTECH**

*Enabling an Intelligent Planet*

**[www.advantech.com](http://www.advantech.com)**

Please verify specifications before quoting. This guide is intended for reference purposes only.

All product specifications are subject to change without notice.

No part of this publication may be reproduced in any form or by any means, electronic, photocopying, recording or otherwise, without prior written permission of the publisher.

All brand and product names are trademarks or registered trademarks of their respective companies.

© Advantech Co., Ltd. 2011