

LM49200 Boomer® Audio Power Amplifier Series Stereo Class AB Audio Subsystem with a True Ground Headphone Amplifier

Check for Samples: [LM49200](#), [LM49200TLEVAL](#)

FEATURES

- Differential Mono Input and Stereo Single-Ended Input
- 32-Step Digital Volume Control (-80 to +18dB)
- Three Independent Volume Channels (Left, Right, Mono)
- Separate Headphone Volume Control
- Flexible Output for Speaker and Headphone Output
- True Ground Headphone Amplifier Eliminates Large DC Blocking Capacitors Reducing PCB Space and Cost
- Receiver Pass-Through Capability
- Soft Enable Function
- RF Immunity Topology
- “Click and Pop” Suppression Circuitry
- Thermal Shutdown Protection
- Micro-Power Shutdown
- I²C Control Interface
- Available in Space-Saving DSBGA Package

KEY SPECIFICATIONS

- Supply Voltage (VDD): $2.7V \leq VDD \leq 5.5V$
- I²C Supply Voltage: $1.7V \leq I2CVDD \leq 5.5V$
- Output power at VDD = 5V, 1% THD+N
 - RL = 8Ω speaker: 1.25W (typ)
 - RL = 32Ω headphone: 38mW (typ)
- Output power at VDD = 3.3V, 1% THD+N
 - RL = 8Ω speaker: 520W (typ)
 - RL = 32Ω headphone: 38mW (typ)
- PSRR:
 - VDD = 3.3V, 217Hz ripple, Mono In: 95dB (typ)
- Shutdown power supply current 0.02μA (typ)

APPLICATIONS

- Portable Electronic Devices
- Mobile Phones
- PDAs

DESCRIPTION

The LM49200 is a fully integrated audio subsystem with a stereo power amplifier capable of delivering 500mW of continuous average power per channel into 8Ω with 1% THD+N using a 3.3V supply. The LM49200 includes a separate stereo headphone amplifier that can deliver 35mW per channel into 32Ω.

The LM49200 has three input channels. A pair of single-ended inputs and a fully differential input channel. The LM49200 features a 32-step digital volume control on the input stage and an 8-step digital volume control on the headphone output stage.

The digital volume control and output modes are programmed through a two-wire I²C compatible interface that allows flexibility in routing and mixing audio channels.

The LM49200 is designed for cellular phone, PDA, and other portable handheld applications. The high level of integration minimizes external components. The True Ground headphone amplifier eliminates the physically large DC blocking output capacitors reducing required board space and reducing cost.



Please be aware that an important notice concerning availability, standard warranty, and use in critical applications of Texas Instruments semiconductor products and disclaimers thereto appears at the end of this data sheet.

All trademarks are the property of their respective owners.

Typical Application

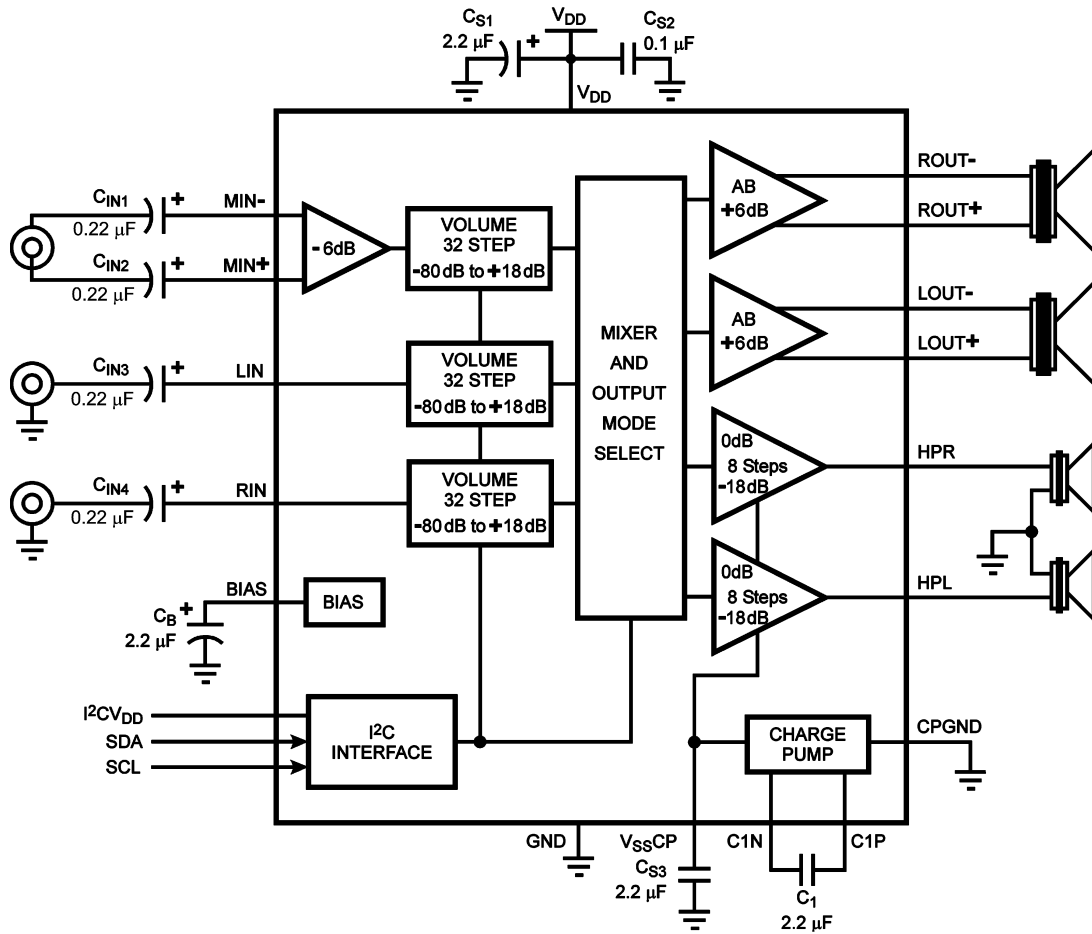
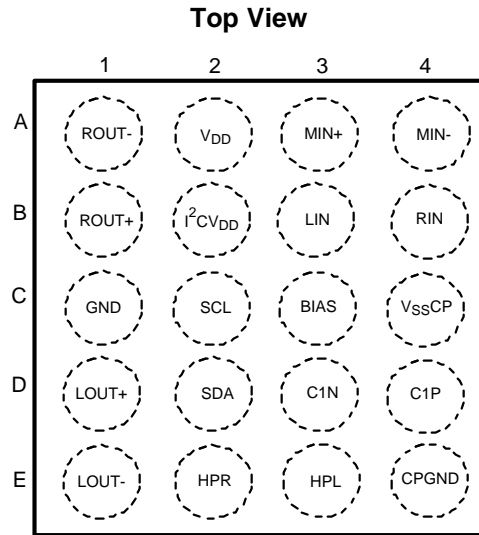

Figure 1. Typical Audio Application Circuit

Connection Diagram



**Figure 2. 20 Bump DSBGA Package
(Bump Side Down)
See Package Number YZR0020BBA**

Bump Descriptions

Bump	Name	Pin Function	Type
A1	ROUT-	Right Loudspeaker Negative Output	Analog Output
A2	VDD	Power Supply	Power Input
A3	MIN+	Differential Mono Positive Input	Analog Input
A4	MIN-	Differential Mono Negative Input	Analog Input
B1	ROUT+	Right Loudspeaker Positive Output	Analog Output
B2	I ² CV _{DD}	I ² C power supply	Power Input
B3	LIN	Single-ended Left Input	Analog Input
B4	RIN	Single-ended Right Input	Analog Input
C1	GND	Power Ground	Ground
C2	SCL	I ² C Clock	Digital Input
C3	BIAS	Half-Supply Bias point, capacitor bypassed	Analog Output
C4	VSSCP	Negative Charge Pump Power Supply	Analog Output
D1	LOUT+	Left Loudspeaker Negative Output	Analog Output
D2	SDA	I ² C Data	Digital Input
D3	C1N	Negative Terminal Charge Pump Flying Capacitor	Analog Output
D4	C1P	Positive Terminal Charge Pump Flying Capacitor	Analog Output
E1	LOUT-	Left Loudspeaker Positive Output	Analog Output
E2	HPR	Right Headphone Output	Analog Output
E3	HPL	Left Headphone Output	Analog Output
E4	CPGND	Charge Pump Ground	Ground



These devices have limited built-in ESD protection. The leads should be shorted together or the device placed in conductive foam during storage or handling to prevent electrostatic damage to the MOS gates.

Absolute Maximum Ratings⁽¹⁾⁽²⁾⁽³⁾

Supply Voltage ⁽¹⁾		6.0V
Storage Temperature		-65°C to +150°C
Voltage at Any Input Pin		GND - 0.3 to V _{DD} + 0.3V
Power Dissipation ⁽⁴⁾		Internally Limited
ESD Rating ⁽⁵⁾		2000V
ESD Rating ⁽⁶⁾		200V
Junction Temperature (T _{JMAX})		150°C
Soldering Information	Vapor Phase (60sec.)	215°C
	Infrared (15sec.)	220°C
See AN-1112 "Micro SMD Wafer Level Chip Scale Package" (SNVA009).		
Thermal Resistance	θ _{JA}	45.1°C/W

- (1) "Absolute Maximum Ratings" indicate limits beyond which damage to the device may occur, including inoperability and degradation of device reliability and/or performance. Functional operation of the device and/or non-degradation at the *Absolute Maximum Ratings* or other conditions beyond those indicated in the *Recommended Operating Conditions* is not implied. The *Recommended Operating Conditions* indicate conditions at which the device is functional and the device should not be operated beyond such conditions. All voltages are measured with respect to the ground pin, unless otherwise specified.
- (2) The *Electrical Characteristics* tables list ensured specifications under the listed *Recommended Operating Conditions* except as otherwise modified or specified by the *Electrical Characteristics Conditions* and/or Notes. Typical specifications are estimations only and are not ensured.
- (3) If Military/Aerospace specified devices are required, please contact the TI Sales Office/ Distributors for availability and specifications.
- (4) The maximum power dissipation must be derated at elevated temperatures and is dictated by T_{JMAX}, θ_{JA}, and the ambient temperature, T_A. The maximum allowable power dissipation is P_{DMAX} = (T_{JMAX} - T_A) / θ_{JA} or the number given in *Absolute Maximum Ratings*, whichever is lower.
- (5) Human body model, applicable std. JESD22-A114C.
- (6) Machine model, applicable std. JESD22-A115-A.

Operating Ratings

Temperature Range T _{MIN} ≤ T _A ≤ T _{MAX}	-40°C ≤ T _A ≤ 85°C
Supply Voltage (V _{DD})	2.7V ≤ V _{DD} ≤ 5.5V
Supply Voltage (I ² CV _{DD})	1.7V ≤ I ² CV _{DD} ≤ 5.5V
	I ² CV _{DD} ≤ V _{DD}

Electrical Characteristics $V_{DD} = 3.3V^{(1)(2)}$

The following specifications apply for $V_{DD} = 3.3V$, $T_A = 25^\circ C$, all volume controls set to 0dB, unless otherwise specified.
 LS = Loudspeaker, HP = Headphone.

Parameter		Test Conditions	LM49200		Units (Limits)
			Typ ⁽³⁾	Limits ⁽⁴⁾	
I_{DD}	Quiescent Power Supply Current	$V_{IN} = 0$, No Loads			
		EP Receiver (Output Mode Bit D4 = 1)	1.2	1.7	mA (max)
		Stereo LS only (Mode 2)	4	5.5	mA (max)
		Stereo HP only (Mode 8)	4.5	6.4	mA (max)
		Stereo LS + Stereo HP (Mode 10)	7.0	9.8	mA (max)
I_{SD}	Shutdown Current		0.02	1	μA (max)
V_{OS}	Output Offset Voltage	$V_{IN} = 0V$, Mode 10 LS output, $R_L = 8\Omega$ BTL HP output, $R_L = 32\Omega$ SE	2.5	15	mV (max)
			1.4	5	mV (max)
P_O	Output Power	LS output, Mode 2, $R_L = 8\Omega$ BTL THD+N = 1%, $f = 1kHz$	520	450	mW (min)
		HP output, Mode 8, $R_L = 32\Omega$ SE THD+N = 1%, $f = 1kHz$	38	35	mW (min)
THD+N	Total Harmonic Distortion + Noise	LS output, $f = 1kHz$, $R_L = 8\Omega$ BTL $P_O = 250mW$, Mode 2	0.05		%
		HP output, $f = 1kHz$, $R_L = 32\Omega$ SE $P_O = 12mW$, Mode 8	0.02		%
SNR	Signal-to-Noise Ratio	LS output, $f = 1kHz$, $V_{REF} = V_{OUT}$ (1%THD+N) Gain = 0dB, A-weighted LIN & RIN AC terminated	105		dB
		HP output, $f = 1kHz$, $V_{REF} = V_{OUT}$ (1%THD+N) Gain = 0dB, A-weighted LIN & RIN AC terminated	101		dB
ϵ_{OUT}	Output Noise	A-weighted, Inputs terminated to AC GND, Output Referred			
		Right LS only, Mode 1	8		μV
		LS: Mode 1	8		μV
		LS: Mode 2	11		μV
		LS: Mode 3	14		μV
		HP: Mode 4	8		μV
		HP: Mode 8	9		μV
PSRR	Power Supply Rejection Ratio	$V_{RIPPLE} = 200mV_{PP}$, $f_{RIPPLE} = 217Hz$, $C_B = 2.2\mu F$ All inputs AC terminated to GND, output referred			
		LS: Mode 1, $R_L = 8\Omega$ BTL	95		dB
		LS: Mode 2, $R_L = 8\Omega$ BTL	75		dB
		HP: Mode 4, $R_L = 32\Omega$ SE	90		dB
		HP: Mode 8, $R_L = 32\Omega$ SE	80		dB

- (1) "Absolute Maximum Ratings" indicate limits beyond which damage to the device may occur, including inoperability and degradation of device reliability and/or performance. Functional operation of the device and/or non-degradation at the *Absolute Maximum Ratings* or other conditions beyond those indicated in the *Recommended Operating Conditions* is not implied. The *Recommended Operating Conditions* indicate conditions at which the device is functional and the device should not be operated beyond such conditions. All voltages are measured with respect to the ground pin, unless otherwise specified.
- (2) The *Electrical Characteristics* tables list ensured specifications under the listed *Recommended Operating Conditions* except as otherwise modified or specified by the *Electrical Characteristics Conditions* and/or Notes. Typical specifications are estimations only and are not ensured.
- (3) Typical values represent most likely parametric norms at $T_A = +25^\circ C$, and at the *Recommended Operation Conditions* at the time of product characterization and are not ensured.
- (4) Datasheet min/max specification limits are ensured by test or statistical analysis.

Electrical Characteristics $V_{DD} = 3.3V^{(1)(2)}$ (continued)

The following specifications apply for $V_{DD} = 3.3V$, $T_A = 25^\circ C$, all volume controls set to 0dB, unless otherwise specified.
LS = Loudspeaker, HP = Headphone.

Parameter		Test Conditions	LM49200		Units (Limits)
			Typ ⁽³⁾	Limits ⁽⁴⁾	
CMRR	Common-Mode Rejection Ratio	f = 217Hz, $V_{CM} = 1V_{P-P}$ LS: $R_L = 8\Omega$ BTL, Mode 1 HP: $R_L = 32\Omega$ SE, Mode 4	60 66		dB dB
		LS: $P_O = 400mW$, f = 1kHz, Mode 2 HP: $P_O = 12mW$, f = 1kHz, Mode 8	80 70		dB dB
Z_{IN}	MIN, LIN, and RIN Input Impedance	Maximum Gain setting	12.5	10 15	k Ω (min) k Ω (max)
		Maximum Attenuation setting	110	90 130	k Ω (min) k Ω (max)
VOL	Digital Volume Control Range	Maximum Gain Maximum Attenuation	18 -80		dB dB
VOL	Volume Control Step Size Error		0.2		dB
T_{WU}	Wake-Up Time from Shutdown	$C_B = 2.2\mu F$, HP, Normal Turn-On Mode	29		ms
		$C_B = 2.2\mu F$, HP, Fast Turn-On Mode	16		ms

Electrical Characteristics $V_{DD} = 5.0V^{(1)(2)}$

The following specifications apply for $V_{DD} = 5.0V$, $T_A = 25^\circ C$, all volume controls set to 0dB, unless otherwise specified.
LS = Loudspeaker, HP = Headphone.

Parameter		Test Conditions	LM49200		Units (Limits)
			Typ ⁽³⁾	Limits ⁽⁴⁾	
I_{DD}	Quiescent Power Supply Current	$V_{IN} = 0$, No Loads			
		EP Receiver (Output Mode Bit D4 = 1)	1.3	1.8	mA (max)
		Stereo LS only (Mode 2)	4.2	5.9	mA (max)
		Stereo HP only (Mode 8)	4.7	6.5	mA (max)
		Stereo LS + Stereo HP (Mode 10)	7.3	10.1	mA (max)
I_{SD}	Shutdown Current		0.02	1	μA (max)
V_{OS}	Output Offset Voltage	$V_{IN} = 0V$, Mode 10 LS output, $R_L = 8\Omega$ BTL HP output, $R_L = 32\Omega$ SE	2.5 1.4	15 5	mV (max) mV (max)
		LS output, Mode 2, $R_L = 8\Omega$ BTL THD+N = 1%, f = 1kHz	1.25		W
P_O	Output Power	HP output, Mode 8, $R_L = 32\Omega$ SE THD+N = 1%, f = 1kHz	38		mW
THD+N	Total Harmonic Distortion + Noise	LS output, f = 1kHz, $R_L = 8\Omega$ BTL $P_O = 400mW$, Mode 2	0.05		%
		HP output, f = 1kHz, $R_L = 32\Omega$ SE $P_O = 12mW$, Mode 8	0.02		%

- (1) "Absolute Maximum Ratings" indicate limits beyond which damage to the device may occur, including inoperability and degradation of device reliability and/or performance. Functional operation of the device and/or non-degradation at the *Absolute Maximum Ratings* or other conditions beyond those indicated in the *Recommended Operating Conditions* is not implied. The *Recommended Operating Conditions* indicate conditions at which the device is functional and the device should not be operated beyond such conditions. All voltages are measured with respect to the ground pin, unless otherwise specified.
- (2) The *Electrical Characteristics* tables list ensured specifications under the listed *Recommended Operating Conditions* except as otherwise modified or specified by the *Electrical Characteristics Conditions* and/or Notes. Typical specifications are estimations only and are not ensured.
- (3) Typical values represent most likely parametric norms at $T_A = +25^\circ C$, and at the *Recommended Operation Conditions* at the time of product characterization and are not ensured.
- (4) Datasheet min/max specification limits are ensured by test or statistical analysis.

Electrical Characteristics $V_{DD} = 5.0V^{(1)(2)}$ (continued)

The following specifications apply for $V_{DD} = 5.0V$, $T_A = 25^\circ C$, all volume controls set to 0dB, unless otherwise specified.
 LS = Loudspeaker, HP = Headphone.

Parameter		Test Conditions	LM49200		Units (Limits)
			Typ ⁽³⁾	Limits ⁽⁴⁾	
SNR	Signal-to-Noise Ratio	LS output, $f = 1kHz$, $V_{REF} = V_{OUT} (1\%THD+N)$ Gain = 0dB, A-weighted LIN & RIN AC terminated	109		dB
		HP output, $f = 1kHz$, $V_{REF} = V_{OUT} (1\%THD+N)$ Gain = 0dB, A-weighted LIN & RIN AC terminated	101		dB
ϵ_{OUT}	Output Noise	A-weighted, Inputs terminated to AC GND, Output Referred			
		Right LS only, Mode 1	8		μV
		LS: Mode 1	8		μV
		LS: Mode 2	11		μV
		LS: Mode 3	14		μV
		HP: Mode 4	8		μV
		HP: Mode 8	9		μV
PSRR	Power Supply Rejection Ratio	$V_{RIPPLE} = 200mV_{P-P}$, $f_{RIPPLE} = 217Hz$, $C_B = 2.2\mu F$ All inputs AC terminated to GND, output referred			
		LS: Mode 1, $R_L = 8\Omega$ BTL	90		dB
		LS: Mode 2, $R_L = 8\Omega$ BTL	70		dB
		HP: Mode 4, $R_L = 32\Omega$ SE	87		dB
CMRR	Common-Mode Rejection Ratio	$f = 217Hz$, $V_{CM} = 1V_{P-P}$ LS: $R_L = 8\Omega$ BTL, Mode 1	60		dB
		HP: $R_L = 32\Omega$ SE, Mode 4	66		dB
X_{TALK}	Crosstalk	LS: $P_O = 1W$, $f = 1kHz$, Mode 2	80		dB
		HP: $P_O = 12mW$, $f = 1kHz$, Mode 8	70		dB
Z_{IN}	MIN, LIN, and RIN Input Impedance	Maximum Gain setting	12.5		k Ω
		Maximum Attenuation setting	110		k Ω
VOL	Digital Volume Control Range	Maximum Gain	18		dB
		Maximum Attenuation	-80		dB
VOL	Volume Control Step Size Error		0.2		dB
T_{WU}	Wake-Up Time from Shutdown	$C_B = 2.2\mu F$, HP, Normal Turn-On Mode	29		ms
		$C_B = 2.2\mu F$, HP, Fast Turn-On Mode	16		ms

I²C Interface⁽¹⁾⁽²⁾

The following specifications apply for $V_{DD} = 5.0V$ and $3.3V$, $2.2V \leq I^2C_{-}V_{DD} \leq 5.5V$, $T_A = 25^\circ C$, unless otherwise specified.

Parameter		Test Conditions	LM49200		Units (Limits)
			Typ ⁽³⁾	Limits ⁽⁴⁾⁽⁵⁾	
t_1	I ² C Clock Period			2.5	μs (min)
t_2	I ² C Data Setup Time			100	ns (min)
t_3	I ² C Data Stable Time			0	ns (min)
t_4	Start Condition Time			100	ns (min)
t_5	Stop Condition Time			100	ns (min)
t_6	I ² C Data Hold Time			100	ns (min)
V_{IH}	I ² C Input Voltage High			$0.7 \times I^2C_{-}V_{DD}$	V (min)
V_{IL}	I ² C Input Voltage Low			$0.3 \times I^2C_{-}V_{DD}$	V (max)

- (1) "Absolute Maximum Ratings" indicate limits beyond which damage to the device may occur, including inoperability and degradation of device reliability and/or performance. Functional operation of the device and/or non-degradation at the *Absolute Maximum Ratings* or other conditions beyond those indicated in the *Recommended Operating Conditions* is not implied. The *Recommended Operating Conditions* indicate conditions at which the device is functional and the device should not be operated beyond such conditions. All voltages are measured with respect to the ground pin, unless otherwise specified.
- (2) The *Electrical Characteristics* tables list ensured specifications under the listed *Recommended Operating Conditions* except as otherwise modified or specified by the *Electrical Characteristics Conditions* and/or Notes. Typical specifications are estimations only and are not ensured.
- (3) Human body model, applicable std. JESD22-A114C.
- (4) Datasheet min/max specification limits are ensured by test or statistical analysis.
- (5) Refer to the I²C timing diagram, [Figure 32](#).

I²C Interface⁽¹⁾⁽²⁾

The following specifications apply for $V_{DD} = 5.0V$ and $3.3V$, $1.7V \leq I^2C_{-}V_{DD} \leq 2.2V$, $T_A = 25^\circ C$, unless otherwise specified.

Parameter		Test Conditions	LM49200		Units (Limits)
			Typ ⁽³⁾	Limits ⁽⁴⁾⁽⁵⁾	
t_1	I ² C Clock Period			2.5	μs (min)
t_2	I ² C Data Setup Time			250	ns (min)
t_3	I ² C Data Stable Time			0	ns (min)
t_4	Start Condition Time			250	ns (min)
t_5	Stop Condition Time			250	ns (min)
t_6	I ² C Data Hold Time			250	ns (min)
V_{IH}	I ² C Input Voltage High			$0.7 \times I^2C_{-}V_{DD}$	V (min)
V_{IL}	I ² C Input Voltage Low			$0.3 \times I^2C_{-}V_{DD}$	V (max)

- (1) "Absolute Maximum Ratings" indicate limits beyond which damage to the device may occur, including inoperability and degradation of device reliability and/or performance. Functional operation of the device and/or non-degradation at the *Absolute Maximum Ratings* or other conditions beyond those indicated in the *Recommended Operating Conditions* is not implied. The *Recommended Operating Conditions* indicate conditions at which the device is functional and the device should not be operated beyond such conditions. All voltages are measured with respect to the ground pin, unless otherwise specified.
- (2) The *Electrical Characteristics* tables list ensured specifications under the listed *Recommended Operating Conditions* except as otherwise modified or specified by the *Electrical Characteristics Conditions* and/or Notes. Typical specifications are estimations only and are not ensured.
- (3) Typical values represent most likely parametric norms at $T_A = +25^\circ C$, and at the *Recommended Operation Conditions* at the time of product characterization and are not ensured.
- (4) Datasheet min/max specification limits are ensured by test or statistical analysis.
- (5) Refer to the I²C timing diagram, [Figure 32](#).

Typical Performance Characteristics

For all performance graphs, the Output Gains are set to 0dB, unless otherwise noted.

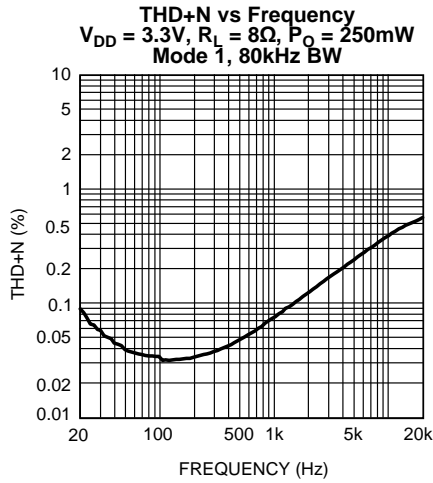

Figure 3.

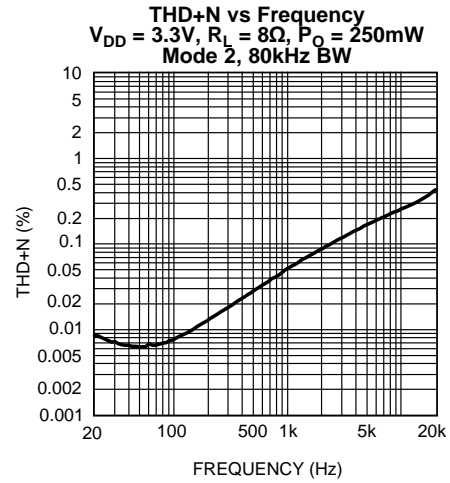

Figure 4.

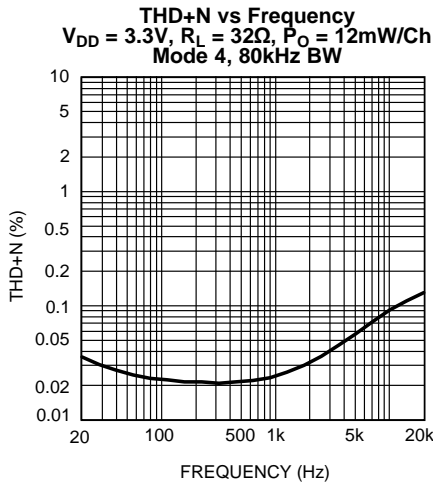

Figure 5.

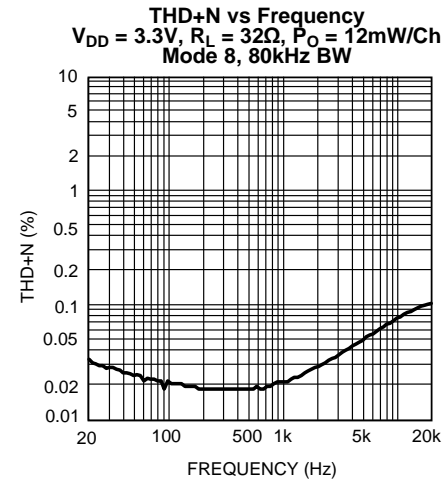

Figure 6.

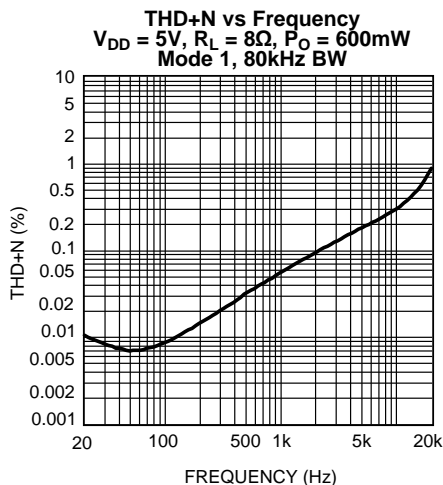

Figure 7.

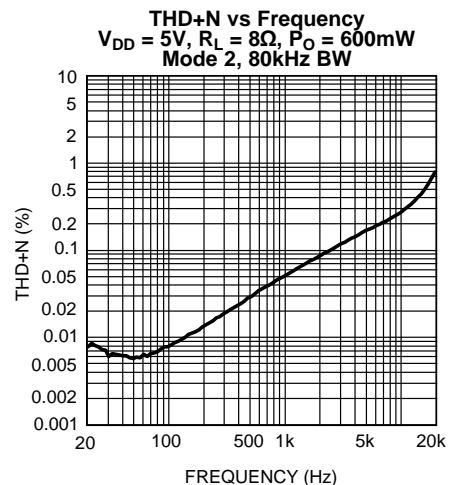

Figure 8.

Typical Performance Characteristics (continued)

For all performance graphs, the Output Gains are set to 0dB, unless otherwise noted.

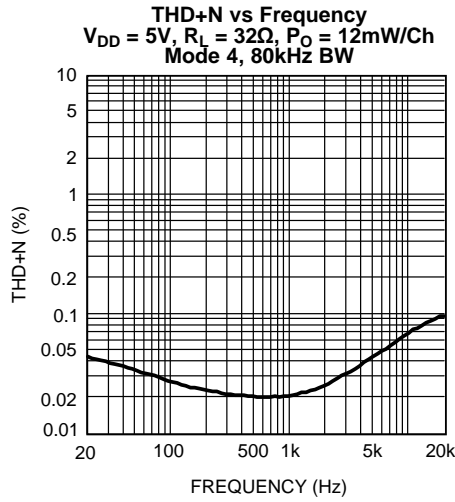

Figure 9.

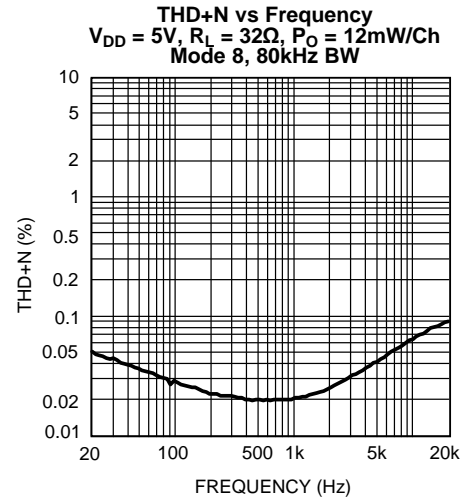

Figure 10.

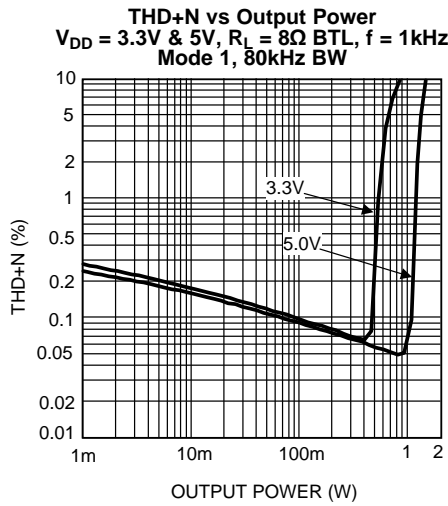

Figure 11.

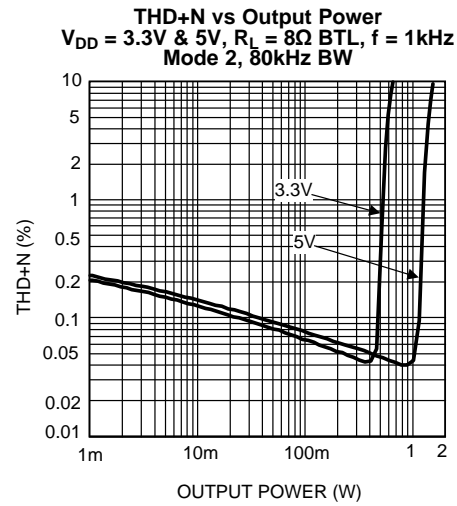

Figure 12.

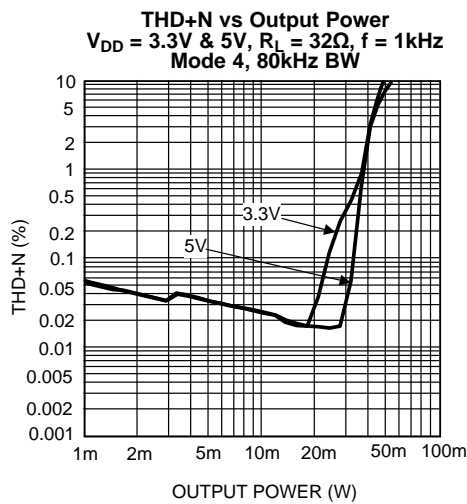

Figure 13.

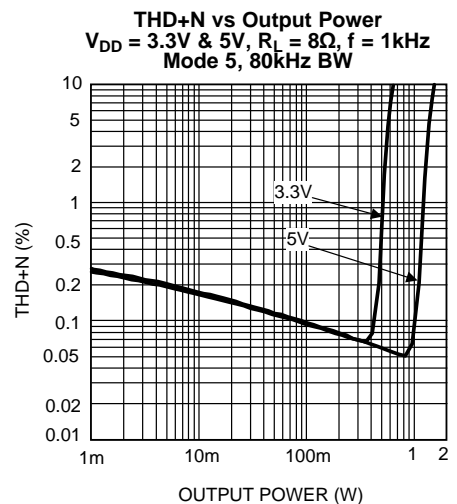

Figure 14.

Typical Performance Characteristics (continued)

For all performance graphs, the Output Gains are set to 0dB, unless otherwise noted.

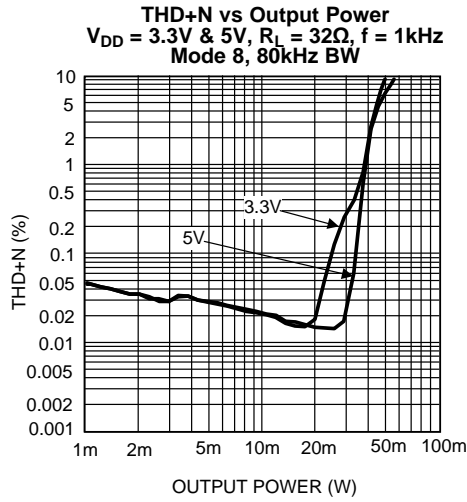

Figure 15.

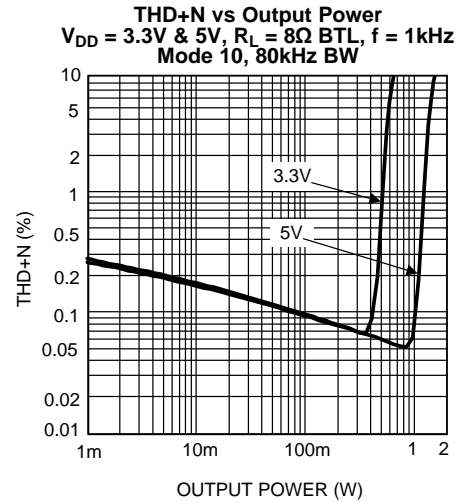

Figure 16.

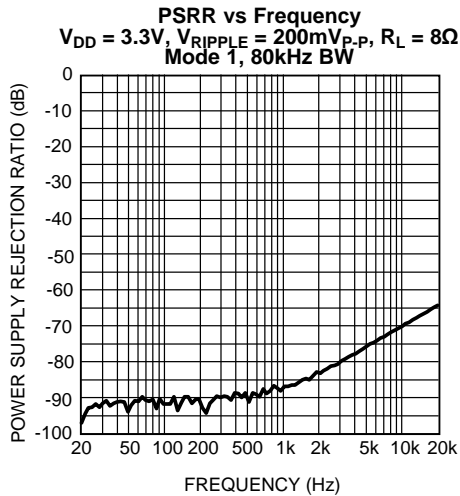

Figure 17.

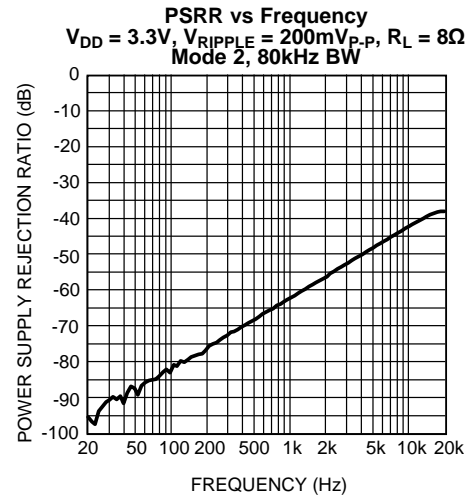

Figure 18.

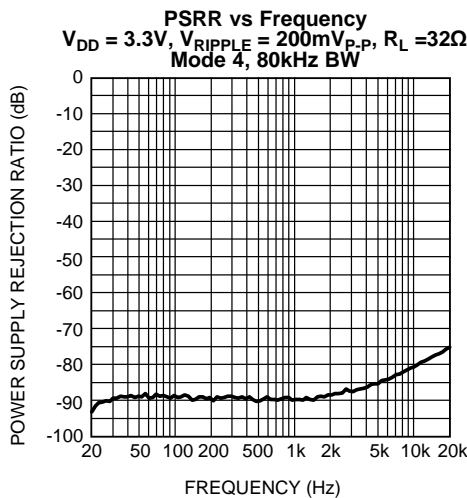

Figure 19.

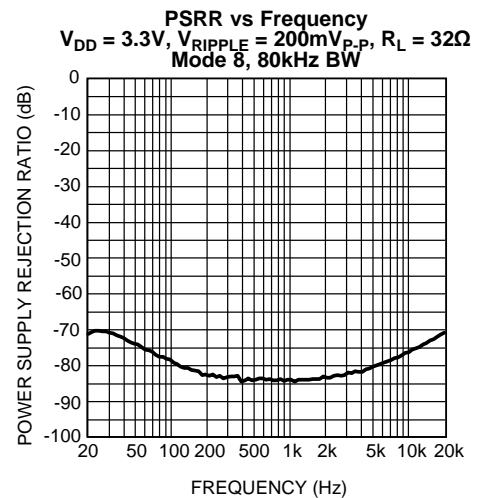

Figure 20.

Typical Performance Characteristics (continued)

For all performance graphs, the Output Gains are set to 0dB, unless otherwise noted.

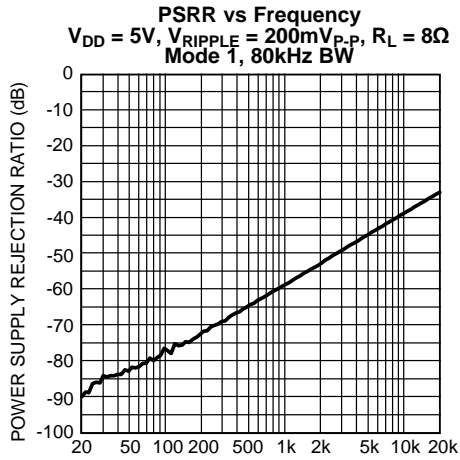

Figure 21.

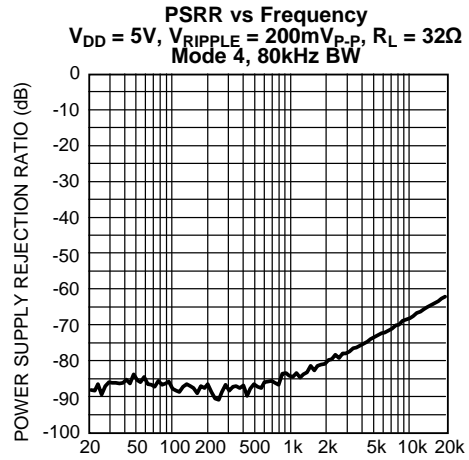

Figure 22.

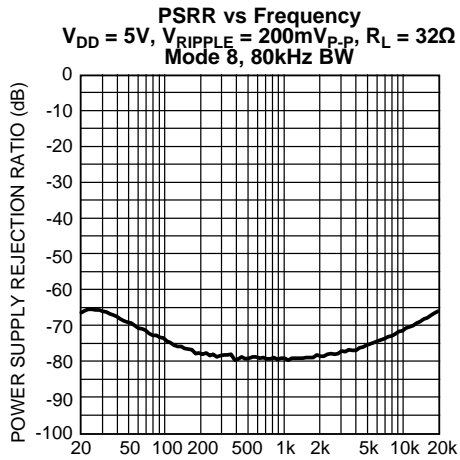

Figure 23.

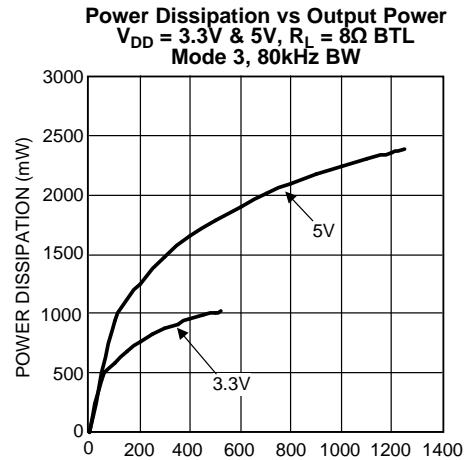

Figure 24.

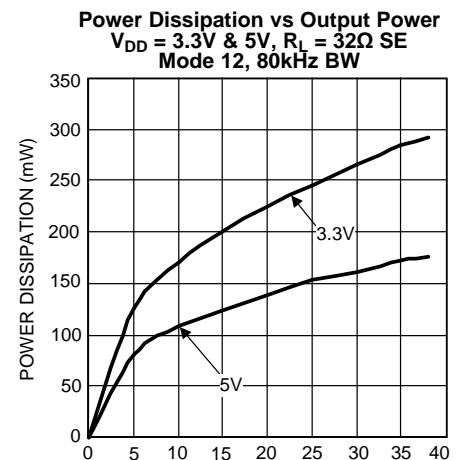

Figure 25.

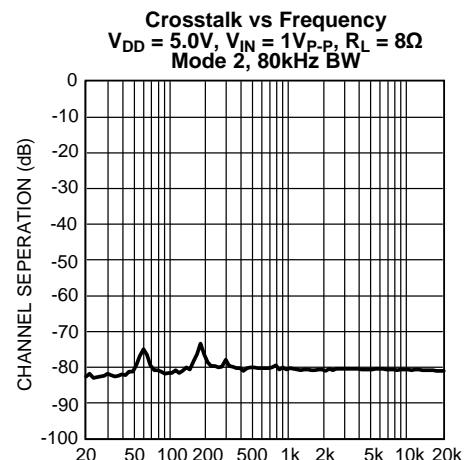

Figure 26.

Typical Performance Characteristics (continued)

For all performance graphs, the Output Gains are set to 0dB, unless otherwise noted.

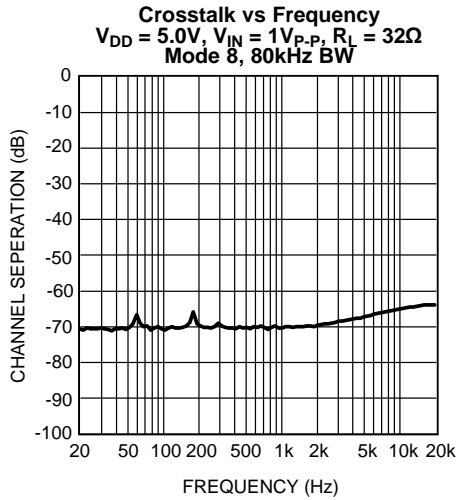

Figure 27.

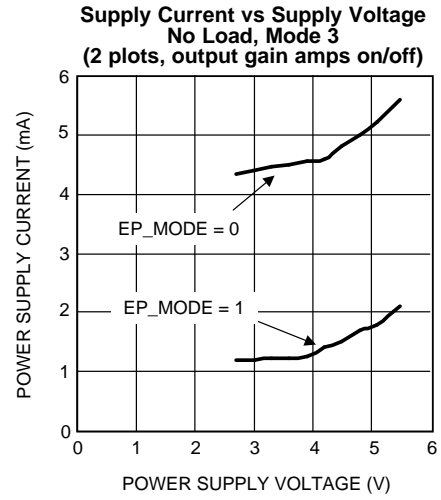

Figure 28.

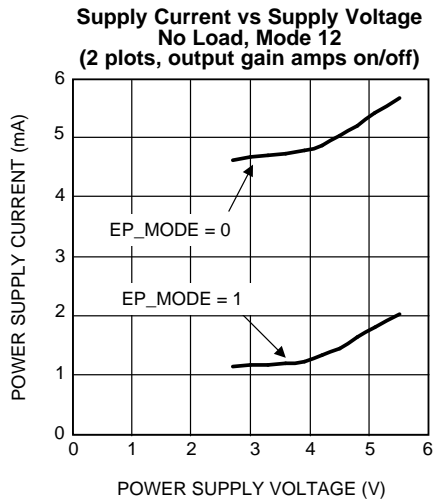

Figure 29.

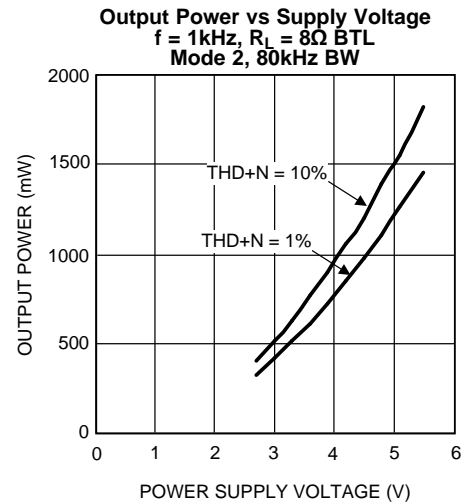

Figure 30.

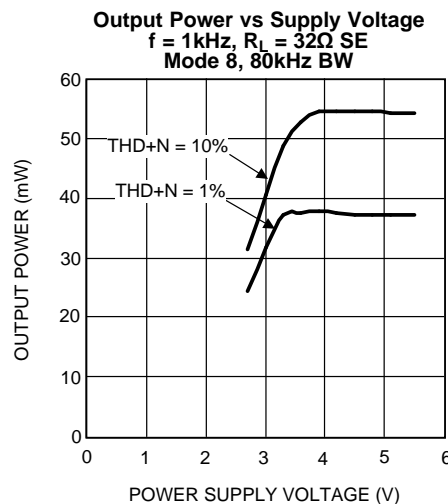

Figure 31.

APPLICATION INFORMATION

I²C COMPATIBLE INTERFACE

The LM49200 is controlled through an I²C compatible serial interface that consists of a serial data line (SDA) and a serial clock (SCL). The clock line is uni-directional. The data line is bi-directional (open drain). The LM49200 and the master can communicate at clock rates up to 400kHz. Figure 32 shows the I²C interface timing diagram. Data on the SDA line must be stable during the HIGH period of SCL. The LM49200 is a transmit/receive slave-only device, reliant upon the master to generate the SCL signal. Each transmission sequence is framed by a START condition and a STOP condition (Figure 33). Each data word, device address and data, transmitted over the bus is 8 bits long and is always followed by an acknowledge pulse (Figure 34). The LM49200 device address is 11111000.

I²C INTERFACE POWER SUPPLY PIN (I²CV_{DD})

The LM49200's I²C interface is powered up through the I²CV_{DD} pin. The LM49200's I²C interface operates at a voltage level set by the I²CV_{DD} pin which can be set independent to that of the main power supply pin V_{DD}. This is ideal whenever logic levels for the I²C interface are dictated by a microcontroller or microprocessor that is operating at a lower supply voltage than the main battery of a portable system

I²C BUS FORMAT

The I²C bus format is shown in Figure 34. The START signal, the transition of SDA from HIGH to LOW while SCL is HIGH, is generated, alerting all devices on the bus that a device address is being written to the bus.

The 7-bit device address is written to the bus, most significant bit (MSB) first, followed by the R \overline{W} bit. R \overline{W} = 0 indicates the master is writing to the slave device, R \overline{W} = 1 indicates the master wants to read data from the slave device. Set R \overline{W} = 0; the LM49200 is a WRITE-ONLY device and will not respond to the R \overline{W} = 1. The data is latched in on the rising edge of the clock. Each address bit must be stable while SCL is HIGH. After the last address bit is transmitted, the master device releases SDA, during which time, an acknowledge clock pulse is generated by the slave device. If the LM49200 receives the correct address, the device pulls the SDA line low, generating an acknowledge bit (ACK).

Once the master device registers the ACK bit, the 8-bit register data word is sent. Each data bit should be stable while SCL is HIGH. After the 8-bit register data word is sent, the LM49200 sends another ACK bit. Following the acknowledgement of the register data word, the master issues a STOP bit, allowing SDA to go high while SCL is high.

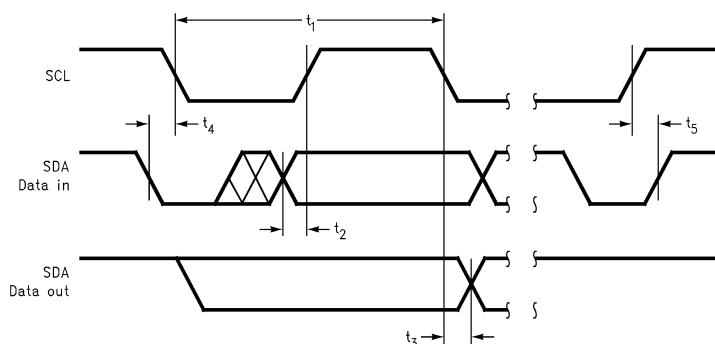

Figure 32. I²C Timing Diagram

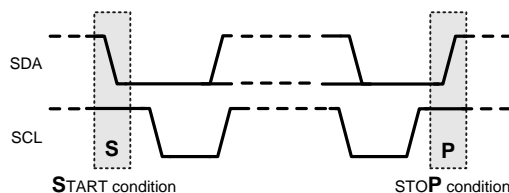

Figure 33. Start and Stop Diagram

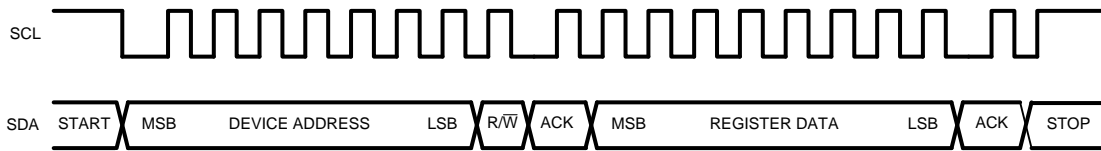

Figure 34. Start and Stop Diagram

Table 1. Chip Address

	A7	A6	A5	A4	A3	A2	A1	A0
Chip Address	1	1	1	1	1	0	0	0

Table 2. Control Registers⁽¹⁾

Register	D7	D6	D5	D4	D3	D2	D1	D0
Shutdown Control	0	0	0	HPR_SD ⁽²⁾	0	I ² CV _{DD} _SD ⁽³⁾	Turn_On_Time ⁽⁴⁾	Power_On ⁽⁵⁾
Output Mode Control	0	1	0	EP_Mode ⁽⁶⁾	Mode_Control ⁽⁷⁾			
Headphone Output Gain Control	1	0	0	0	0	HP_Gain ⁽⁸⁾		
Mono Input Volume Control	1	0	1	Mono_Vol ⁽⁹⁾				
Left Input Volume Control	1	1	0	Left_Vol ⁽⁹⁾				
Right Input Volume Control	1	1	1	Right_Vol ⁽⁹⁾				

- (1) **Notes:** All registers default to 0 on initial power-up.
(2) HPR_SD: Right channel shutdown control. See Table 3.
(3) I²CV_{DD}_SD: Control Enable Function. I²CV_{DD} can be used to act as a hardware reset input. See Table 3.
(4) Turn_On_Time: Reduces the turn on time for faster activation. See Table 3.
(5) Power_On: Master Power on bit. See Table 3.
(6) EP_Mode: EP (Receiver) Mode control. Right loudspeaker channel can be used as earpiece path. See Table 4.
(7) Mode_Control: Sets the output mode. See Table 4.
(8) HP_Gain: Sets the headphone amplifier output gain. See Table 5
(9) Mono_Vol/Left_Vol/Right_Vol: Sets the input volume for Mono, Left and Right inputs. See Table 6.

Table 3. Shutdown Control Register

Bit	Name	Value	Description
0	Power_On		This bit is a master shutdown control bit and sets the device to be on or off.
		Value	Status
		0	Master power off, device disable.
		1	Master power on, device enable.
1	Turn_On_Time		This bit sets the turn on time of the device.
		Value	Status
		0	Normal Turn-on time
		1	Fast Turn-on time
2	I ² CV _{DD} _SD		This bit allows the I ² C supply voltage to be used as a reset signal.
		Value	Status
		0	I ² CV _{DD} acts as an active low reset input. If I ² CV _{DD} drops below 1.1V, the device resets and the I ² C registers are restored to their default state.
		1	Normal Operation. I ² CV _{DD} voltage does not reset the device.
4	HPR_SD		This bit is used when only one channel of the headphone amplifier is needed.
		0	Normal headphone operation.
		1	Mono headphone output at left channel, right headphone in shutdown.

Table 4. Output Mode Control Register⁽¹⁾

Bits	Field	Description					
3:0	Mode_Control	These bits determine how the input signals are mixed and routed to the outputs.					
		Value	Mode	Left Loudspeaker	Right Loudspeaker	Left Headphone	Right Headphone
		0000	0	SD	SD	SD	SD
		0001	1	$G_M \times M$	$G_M \times M$	Mute	Mute
		0010	2	$G_L \times L$	$G_L \times L$	Mute	Mute
		011	3	$G_L \times L + G_M \times M$	$G_R \times R + G_M \times M$	Mute	Mute
		0100	4	SD	SD	$G_M \times M/2$	$G_M \times M/2$
		0101	5	$G_M \times M$	$G_M \times M$	$G_M \times M/2$	$G_M \times M/2$
		0110	6	$G_L \times L$	$G_R \times R$	$G_M \times M/2$	$G_M \times M/2$
		0111	7	$G_L \times L + G_M \times M$	$G_L \times L + G_M \times M$	$G_M \times M/2$	$G_M \times M/2$
		1000	8	SD	SD	$G_L \times L$	$G_R \times R$
		1001	9	$G_M \times M$	$G_M \times M$	$G_L \times L$	$G_R \times R$
		1010	10	$G_L \times L$	$G_R \times R$	$G_L \times L$	$G_R \times R$
		1011	11	$G_L \times L + G_M \times M$	$G_R \times R + G_M \times M$	$G_L \times L$	$G_R \times R$
		1100	12	SD	SD	$G_L \times L + G_M \times M/2$	$G_R \times R + G_M \times M/2$
		1101	13	$G_M \times M$	$G_M \times M$	$G_L \times L + G_M \times M/2$	$G_R \times R + G_M \times M/2$
1110	14	$G_L \times L$	$G_R \times R$	$G_L \times L + G_M \times M/2$	$G_R \times R + G_M \times M/2$		
1111	15	$G_L \times L + G_M \times M$	$G_R \times R + G_M \times M$	$G_L \times L + G_M \times M/2$	$G_R \times R + G_M \times M/2$		
4	EP Mode	This bit sets the loudspeaker amplifiers for earpiece mode.					
		Value	Status				
		0	Normal loudspeaker operation, control determined by bits 3:0.				
1	Bit overrides bits 3:0. Right loudspeaker amplifier bias current reduced for low power operation. Left loudspeaker amplifier shutdown. Mono input path active and signal routed to right loudspeaker output. Left & right input gain amplifiers shutdown for reduced power consumption.						

- (1) M : MIN, Mono differential input
L : LIN, Left single-ended input
R : RIN, Right single-ended input
SD : Shutdown
 G_M : Mono_Vol setting determined by the Mono Input Volume Control register, See [Table 6](#).
 G_L : Left_Vol setting determined by the Left Input Volume Control register, See [Table 6](#).
 G_R : Right_Vol setting determined by the Right Input Volume Control register, See [Table 6](#).

Table 5. Output Gain Control Register

Bits	Field	Description	
2:0	HP_GAIN	These bits set the gain of the headphone output amplifiers.	
		Value	Gain (dB)
		000	0
		001	-1.2
		010	-2.5
		011	-4.0
		100	-6.0
		101	-8.5
		110	-12
111	-18		

Table 6. Input Volume Control Registers

Bits	Fields	Description		
4:0	Mono_Vol Right_Vol Left_Vol	These bits set the input volume for each input volume register listed.		
		Volume Step	Value	Gain (dB)
		1	00000	-80.0
		2	00001	-46.5
		3	00010	-40.5
		4	00011	-34.5
		5	00100	-30.0
		6	00101	-27.0
		7	00110	-24.0
		8	00111	-21.0
		9	01000	-18.0
		10	01001	-15.0
		11	01010	-13.5
		12	01011	-12.0
		13	01100	-10.5
		14	01101	-9.0
		15	01110	-7.5
		16	01111	-6.0
		17	10000	-4.5
		18	10001	-3.0
		19	10010	-1.5
		20	10011	0.0
		21	10100	1.5
		22	10101	3.0
		23	10110	4.5
		24	10111	6.0
		25	11000	7.5
		26	11001	9.0
		27	11010	10.5
		28	11011	12.0
		29	11100	13.5
		30	11101	15.0
		31	11110	16.5
32	11111	18.0		

TURN_ON_TIME BIT

The Turn_On_Time bit determines the delay time from the Power_On bit set to '1' and the internal circuits ready. For input capacitor values up to 0.47 μ F the Turn_On_Time bit can be set to fast mode by setting the bit to a '1'. When the input capacitor values are larger than 0.47 μ F then the Turn_On_Time bit should be set to '0' for normal turn-on time and higher delay. This allows sufficient time to charge the input capacitors to the $\frac{1}{2} V_{DDLS}$ bias voltage.

POWER_ON BIT

The Power_On bit is the master control bit to activate or deactivate the LM49200. All registers can be loaded independent of the Power_On bit setting as long as the IC is powered correctly. Cycling the Power_On bit does not change the values of any registers nor return all bits to the default power on value of zero. The Power_On bit only determines whether the IC is on or off.

HPR_SD BIT

The HPR_SD bit will deactivate the right headphone output amplifier. This bit is provided to reduce power consumption when only one headphone output is needed.

MODE_CONTROL BITS

In the LM49200 OUTPUT MODE CONTROL register (Table 4), Bit B5 (EP Bypass) controls the operation of the Earpiece Bypass path. If EP Bypass = 0, it would act under normal output mode operation set by bits B3, B2, B1, and B0. If EP Bypass = 1, it overrides the B3, B2, B1, and B0 Bits and enables the Receiver Bypass path, a class AB amplifier, to the speaker output.

Bit B4 (HPR_SD) of the OUPUT MODE CONTROL register controls the right headphone shutdown. If HPR_SD = 1, the right headphone output is disabled.

The LM49200 includes a comprehensive mixer multiplexer controlled through the I²C interface. The mixer/multiplexer allows any input combination to appear on any output of LM49200. Multiple input paths can be selected simultaneously. Under these conditions, the selected inputs are mixed together and output on the selected channel. Table 5 shows how the input signals are mixed together for each possible input selection.

HP_GAIN BITS

The headphone outputs have an additional, single volume control set by the three HP_Gain bits in the Output Gain Control register. The HP_Gain volume setting controls the output level for both the left and the right headphone outputs.

LS (EP_MODE) BIT

The LS (EP_Mode) bit selects the amount of bias current in the loudspeaker amplifier. Setting the LS (EP_Mode) bit to a '1' will reduce the amount of current from the V_{DD}LS supply by approximately 0.5mA. The THD performance of the loudspeaker amplifier will be reduced as a result of lower bias current. See the performance graphs in [Typical Performance Characteristics](#) above.

VOLUME CONTROL BITS

The LM49200 has three independent 32-step volume controls, one for each of the inputs. The five bits of the Volume Control registers sets the volume for the specified input channel.

SHUTDOWN FUNCTION

The LM49200 features the following shutdown controls.

Bit B4 (GAMP_SD) of the SHUTDOWN CONTROL register controls the gain amplifiers. When GAMP_SD = 1, it disables the gain amplifiers that are not in use. For example, in Modes 1, 4 and 5, the Mono inputs are in use, so the Left and Right input gain amplifiers are disabled, causing the I_{DD} to be minimized.

Bit B0 (PWR_On) of the SHUTDOWN CONTROL register is the global shutdown control for the entire device. Set PWR_On = 0 for normal operation. PWR_On = 1 overrides any other shutdown control bit.

DIFFERENTIAL AMPLIFIER EXPLANATION

The LM49200 features a differential input stage, which offers improved noise rejection compared to a single-ended input amplifier. Because a differential input amplifier amplifies the difference between the two input signals, any component common to both signals is cancelled. An additional benefit of the differential input structure is the possible elimination of the DC input blocking capacitors. Since the DC component is common to both inputs, and thus cancelled by the amplifier, the LM49200 can be used without input coupling capacitors when configured with a differential input signal.

BRIDGE CONFIGURATION EXPLAINED

By driving the load differentially through the MONO outputs, an amplifier configuration commonly referred to as “bridged mode” is established. Bridged mode operation is different from the classical single-ended amplifier configuration where one side of the load is connected to ground.

A bridge amplifier design has a few distinct advantages over the single-ended configuration, as it provides differential drive to the load, thus doubling output swing for a specified supply voltage. Four times the output power is possible as compared to a single-ended amplifier under the same conditions. This increase in attainable output power assumes that the amplifier is not current limited or clipped.

A bridge configuration, such as the one used in LM49200, also creates a second advantage over single-ended amplifiers. Since the differential outputs are biased at half-supply, no net DC voltage exists across the load. This eliminates the need for an output coupling capacitor which is required in a single supply, single-ended amplifier configuration. Without an output coupling capacitor, the half-supply bias across the load would result in both increased internal IC power dissipation and also possible loudspeaker damage.

POWER DISSIPATION

Power dissipation is a major concern when designing a successful amplifier, whether the amplifier is bridged or single-ended. A direct consequence of the increased power delivered to the load by a bridge amplifier is an increase in internal power dissipation. The power dissipation of the LM49200 varies with the mode selected. The maximum power dissipation occurs in modes where all inputs and outputs are active (Modes 6, 7, 8, 9, 10, 11, 13, 14, 15). The power dissipation is dominated by the Class AB amplifier. The maximum power dissipation for a given application can be derived from the power dissipation graphs or from [Equation 1](#).

$$P_{DMAX} = 4 \cdot (V_{DD})^2 / (2\pi^2 R_L) \quad (1)$$

It is critical that the maximum junction temperature (T_{JMAX}) of 150°C is not exceeded. T_{JMAX} can be determined from the power derating curves by using P_{DMAX} and the PC board foil area. By adding additional copper foil, the thermal resistance of the application can be reduced from the free air value, resulting in higher P_{DMAX} . Additional copper foil can be added to any of the leads connected to the LM49200. It is especially effective when connected to V_{DD} , GND, and the output pins. Refer to the application information on the LM49200 reference design board for an example of good heat sinking. If T_{JMAX} still exceeds 150°C, then additional changes must be made. These changes can include reduced supply voltage, higher load impedance, or reduced ambient temperature. Internal power dissipation is a function of output power. Refer to the curves in [Typical Performance Characteristics](#) for power dissipation information for different output powers and output loading.

POWER SUPPLY BYPASSING

As with any amplifier, proper supply bypassing is critical for low noise performance and high power supply rejection. The capacitor location on both the bypass and power supply pins should be as close to the device as possible. Typical applications employ a 5V regulator with 10µF tantalum or electrolytic capacitor and a ceramic bypass capacitor which aid in supply stability. This does not eliminate the need for bypassing the supply nodes of the LM49200. The selection of a bypass capacitor, especially C_B , is dependent upon PSRR requirements, click and pop performance, system cost, and size constraints.

GROUND REFERENCED HEADPHONE AMPLIFIER

The LM49200 features a low noise inverting charge pump that generates an internal negative supply voltage. This allows the headphone outputs to be biased about GND instead of a nominal DC voltage, like traditional headphone amplifiers. Because there is no DC component, the large DC blocking capacitors (typically 220µF) are not necessary. The coupling capacitors are replaced by two small ceramic charge pump capacitors, saving board space and cost. Eliminating the output coupling capacitors also improves low frequency response. In traditional headphone amplifiers, the headphone impedance and the output capacitor from a high-pass filter that not only blocks the DC component of the output, but also attenuates low frequencies, impacting the bass response. Because the LM49200 does not require the output coupling capacitors, the low frequency response of the device is not degraded by external components. In addition to eliminating the output coupling capacitors, the ground referenced output nearly doubles the available dynamic range of the LM49200 headphone amplifiers when compared to a traditional headphone amplifier operating from the same supply voltage.

INPUT CAPACITOR SELECTION

Input capacitors may be required for some applications, or when the audio source is single-ended. Input capacitors block the DC component of the audio signal, eliminating any conflict between the DC component of the audio source and the bias voltage of the LM49200. The input capacitors create a high-pass filter with the input resistors R_{IN} . The -3dB point of the high-pass filter is found using equation below.

$$f = 1 / 2\pi R_{IN} C_{IN} \quad (\text{Hz})$$

where

- the value of R_{IN} is given in the [Electrical Characteristics](#) Table. (2)

High-pass filtering the audio signal helps protect the speakers. When the LM49200 is using a single-ended source, power supply noise on the ground is seen as an input signal. Setting the high-pass filter point above the power supply noise frequencies, 217Hz in a GSM phone, for example, filters out the noise such that it is not amplified and heard on the output. Capacitors with a tolerance of 10% or better are recommended for impedance matching and improved CMRR and PSRR.

CHARGE PUMP FLYING CAPACITOR (C_1)

The flying capacitor (C_1), see [Figure 1](#), affects the load regulation and output impedance of the charge pump. A C_1 value that is too low results in a loss of current drive, leading to a loss of amplifier headroom. A higher valued C_1 improves load regulation and lowers charge pump output impedance to an extent. Above 2.2 μ F, the $R_{DS(ON)}$ of the charge pump switches and the ESR of C_1 and C_{S5} dominate the output impedance. A lower value capacitor can be used in systems with low maximum output power requirements.

CHARGE PUMP HOLD CAPACITOR (C_{S3})

The value and ESR of the hold capacitor (C_{S5}) directly affects the ripple on CPV_{SS} . Increasing the value of C_{S5} reduces output ripple. Decreasing the ESR of C_{S5} reduces both output ripple and charge pump output impedance. A lower value capacitor can be used in systems with low maximum output power requirements.

Demo Board Circuit

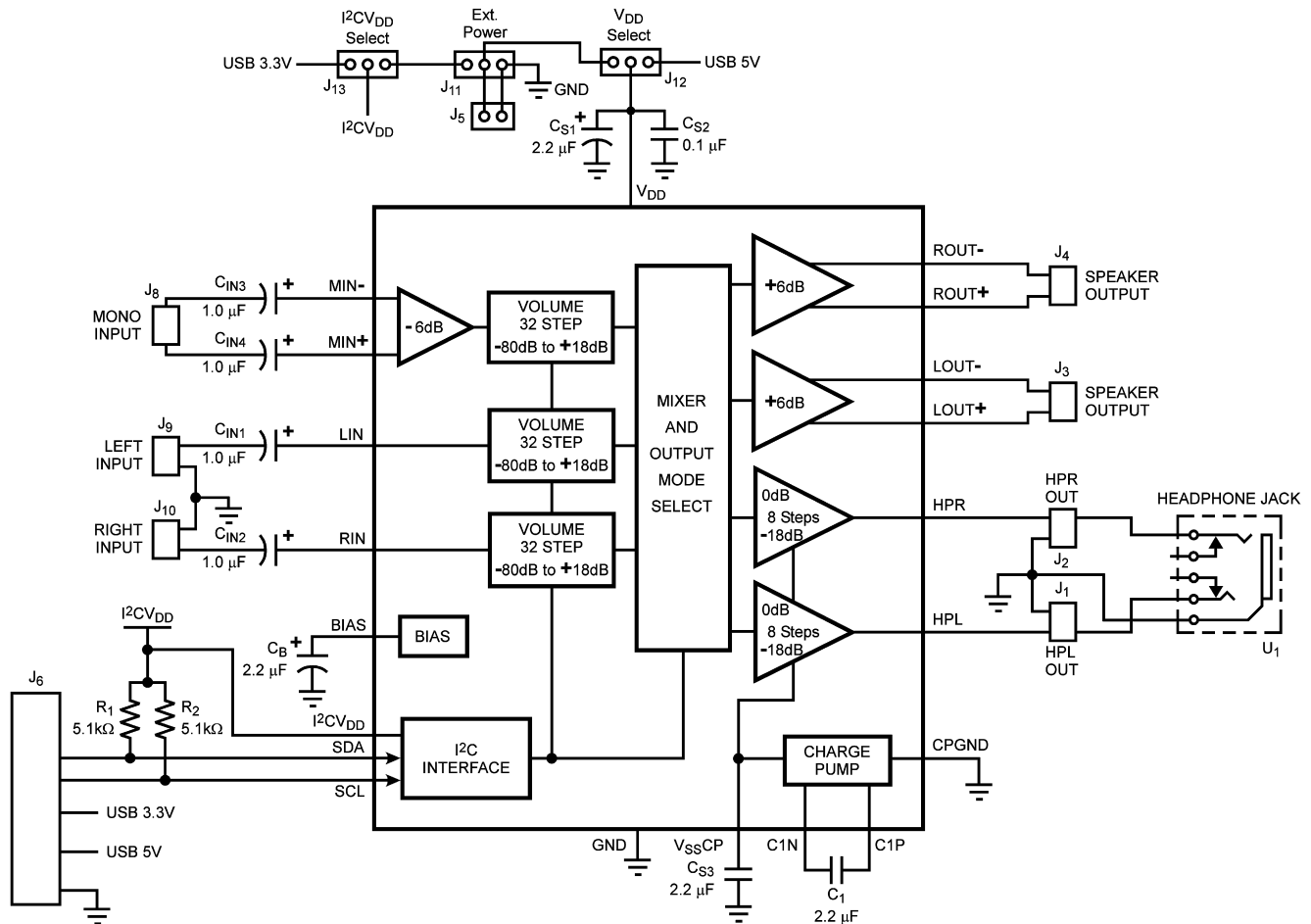

Figure 35. Demo Board Circuit

Demonstration Board

The demonstration board (see Figure 35) has connection and jumper options to be powered from the USB bus, from external power supplies or a combination of both. Additional options are to power I^2CV_{DD} and V_{DD} from a single power supply or separate power supplies, as long as the voltage limits for each supply are not exceeded. See the [Operating Ratings](#) for each supply's limit range. When powered from the USB bus the I^2CV_{DD} will be set to 3.3V and the V_{DD} will be set to 5V. Jumper headers J13 and J12 must be set accordingly. If a single power supply for I^2CV_{DD} and V_{DD} is desired then header J5 should be used with a jumper added to header J11 to connect I^2CV_{DD} to the external supply voltage connected to J5.

Connection headers J1 and J2 are provided along with the stereo headphone jack J4 for easily connection and monitoring of the headphone outputs.

LM49200 microSMD Demo Board Views

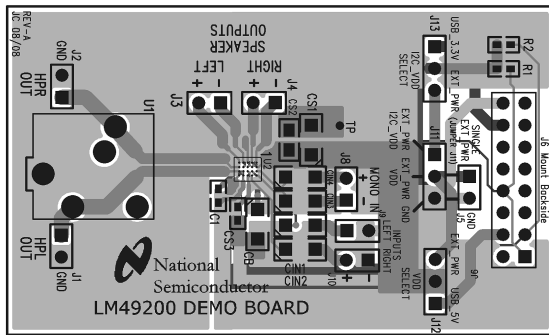

Figure 36. Composite View

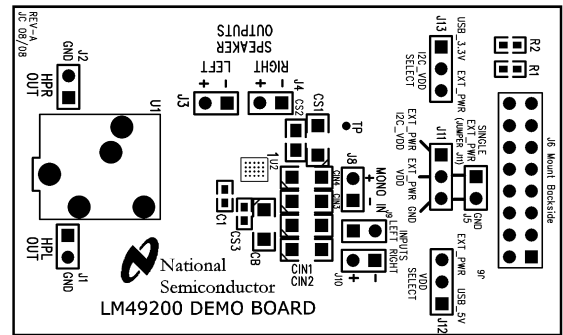

Figure 37. Silk Screen

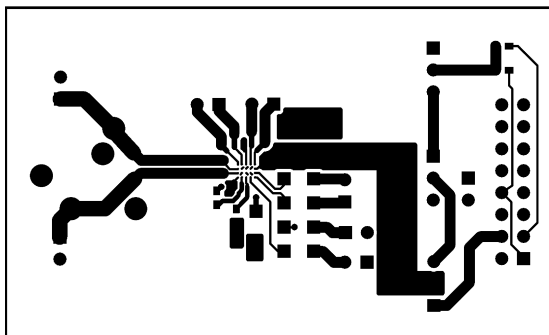

Figure 38. Top Layer

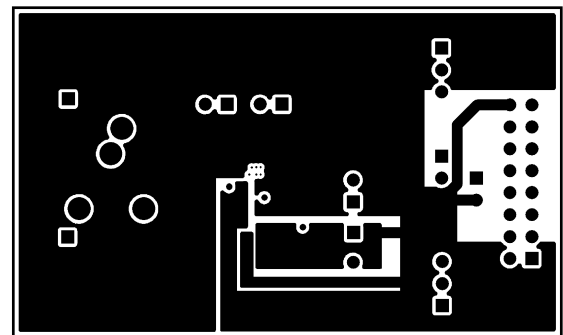

Figure 39. Internal Layer 1

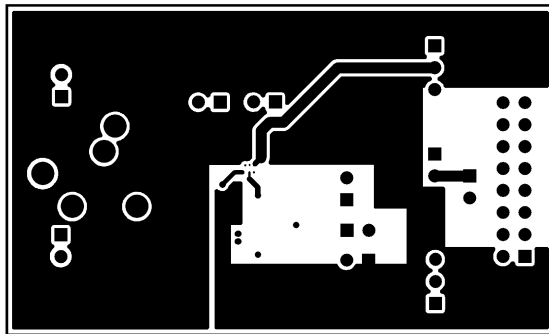

Figure 40. Internal Layer 2

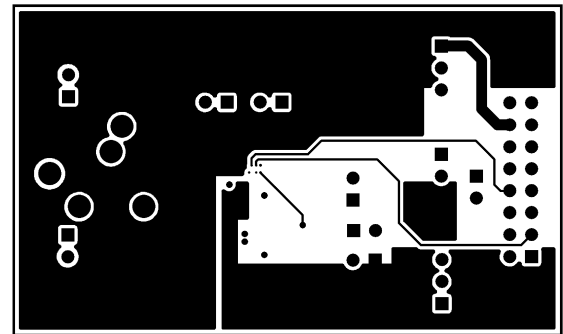

Figure 41. Bottom Layer

LM49200 Reference Demo Board Bill Of Materials
Table 7. Bill Of Materials

Designator	Value	Tolerance	Part Description	Comment
R ₁ , R ₂	5.1kΩ	5%	1/10W, 0603 Resistors	
C _{IN1} , C _{IN2} C _{IN3} , C _{IN4}	1μF	10%	1206, X7R Ceramic Capacitor	
C _{S1} , C _B	2.2μF	10%	Size A, Tantalum Capacitor	
C _{S2}	0.1μF	10%	0805, 16V, X7R Ceramic Capacitor	
C _{S3} , C ₁	2.2μF	10%	0603, 10V, X7R Ceramic Capacitor	
U ₂			LM49200TL	
J ₁ , J ₂ , J ₃ J ₄ , J ₅ , J ₈ J ₉ , J ₁₀			0.100" 1x2 header, vertical mount	Input, Output, V _{DD} , GND
J ₁₁ , J ₁₂ , J ₁₃			0.100" 1x3 header, vertical mount	V _{DD} Selects, V _{DD} , I ² C V _{DD} , GND
J ₆			16 pin header	I ² C Connector
U ₁			Headphone Jack	

PCB Layout Guidelines

This section provides practical guidelines for mixed signal PCB layout that involves various digital/analog power and ground traces. Designers should note that these are only "rule-of-thumb" recommendations and the actual results will depend heavily on the final layout.

General Mixed Signal Layout Recommendations
SINGLE-POINT POWER AND GROUND CONNECTIONS

The analog power traces should be connected to the digital traces through a single point (link). A "Pi-filter" can be helpful in minimizing high frequency noise coupling between the analog and digital sections. It is further recommended to put digital and analog power traces over the corresponding digital and analog ground traces to minimize noise coupling.

PLACEMENT OF DIGITAL AND ANALOG COMPONENTS

All digital components and high-speed digital signals traces should be located as far away as possible from analog components and circuit traces.

AVOIDING TYPICAL DESIGN AND LAYOUT PROBLEMS

Avoid ground loops or running digital and analog traces parallel to each other (side-by-side) on the same PCB layer. When traces must cross over each other do it at 90 degrees. Running digital and analog traces at 90 degrees to each other from the top to the bottom side as much as possible will minimize capacitive noise coupling and cross talk.

REVISION HISTORY

Rev	Date	Description
1.0	05/21/09	Initial release.
A	04/08/2013	Changed layout of National Data Sheet to TI format.

PACKAGING INFORMATION

Orderable Device	Status (1)	Package Type	Package Drawing	Pins	Package Qty	Eco Plan (2)	Lead finish/ Ball material (6)	MSL Peak Temp (3)	Op Temp (°C)	Device Marking (4/5)	Samples
LM49200TL/NOPB	ACTIVE	DSBGA	YZR	20	250	RoHS & Green	SNAGCU	Level-1-260C-UNLIM	-40 to 85	GL3	Samples
LM49200TLX/NOPB	ACTIVE	DSBGA	YZR	20	3000	RoHS & Green	SNAGCU	Level-1-260C-UNLIM	-40 to 85	GL3	Samples

(1) The marketing status values are defined as follows:

ACTIVE: Product device recommended for new designs.

LIFEBUY: TI has announced that the device will be discontinued, and a lifetime-buy period is in effect.

NRND: Not recommended for new designs. Device is in production to support existing customers, but TI does not recommend using this part in a new design.

PREVIEW: Device has been announced but is not in production. Samples may or may not be available.

OBSOLETE: TI has discontinued the production of the device.

(2) **RoHS:** TI defines "RoHS" to mean semiconductor products that are compliant with the current EU RoHS requirements for all 10 RoHS substances, including the requirement that RoHS substance do not exceed 0.1% by weight in homogeneous materials. Where designed to be soldered at high temperatures, "RoHS" products are suitable for use in specified lead-free processes. TI may reference these types of products as "Pb-Free".

RoHS Exempt: TI defines "RoHS Exempt" to mean products that contain lead but are compliant with EU RoHS pursuant to a specific EU RoHS exemption.

Green: TI defines "Green" to mean the content of Chlorine (Cl) and Bromine (Br) based flame retardants meet JS709B low halogen requirements of <=1000ppm threshold. Antimony trioxide based flame retardants must also meet the <=1000ppm threshold requirement.

(3) MSL, Peak Temp. - The Moisture Sensitivity Level rating according to the JEDEC industry standard classifications, and peak solder temperature.

(4) There may be additional marking, which relates to the logo, the lot trace code information, or the environmental category on the device.

(5) Multiple Device Markings will be inside parentheses. Only one Device Marking contained in parentheses and separated by a "~" will appear on a device. If a line is indented then it is a continuation of the previous line and the two combined represent the entire Device Marking for that device.

(6) Lead finish/Ball material - Orderable Devices may have multiple material finish options. Finish options are separated by a vertical ruled line. Lead finish/Ball material values may wrap to two lines if the finish value exceeds the maximum column width.

Important Information and Disclaimer:The information provided on this page represents TI's knowledge and belief as of the date that it is provided. TI bases its knowledge and belief on information provided by third parties, and makes no representation or warranty as to the accuracy of such information. Efforts are underway to better integrate information from third parties. TI has taken and continues to take reasonable steps to provide representative and accurate information but may not have conducted destructive testing or chemical analysis on incoming materials and chemicals. TI and TI suppliers consider certain information to be proprietary, and thus CAS numbers and other limited information may not be available for release.

In no event shall TI's liability arising out of such information exceed the total purchase price of the TI part(s) at issue in this document sold by TI to Customer on an annual basis.

TAPE AND REEL INFORMATION

QUADRANT ASSIGNMENTS FOR PIN 1 ORIENTATION IN TAPE

*All dimensions are nominal

Device	Package Type	Package Drawing	Pins	SPQ	Reel Diameter (mm)	Reel Width W1 (mm)	A0 (mm)	B0 (mm)	K0 (mm)	P1 (mm)	W (mm)	Pin1 Quadrant
LM49200TL/NOPB	DSBGA	YZR	20	250	178.0	8.4	2.18	2.69	0.76	4.0	8.0	Q1
LM49200TLX/NOPB	DSBGA	YZR	20	3000	178.0	8.4	2.18	2.69	0.76	4.0	8.0	Q1

TAPE AND REEL BOX DIMENSIONS

*All dimensions are nominal

Device	Package Type	Package Drawing	Pins	SPQ	Length (mm)	Width (mm)	Height (mm)
LM49200TL/NOPB	DSBGA	YZR	20	250	208.0	191.0	35.0
LM49200TLX/NOPB	DSBGA	YZR	20	3000	208.0	191.0	35.0

YZR0020

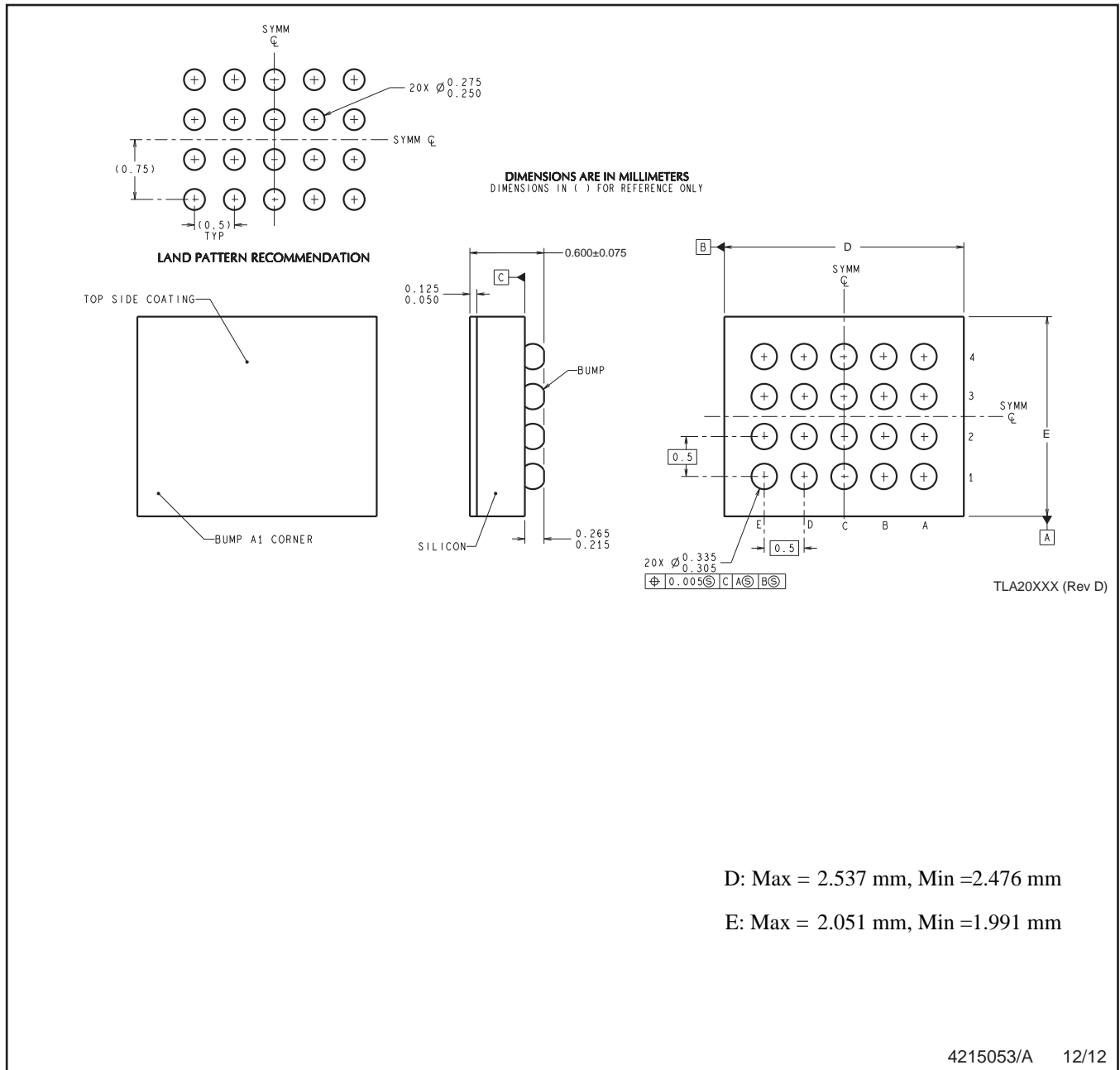

NOTES: A. All linear dimensions are in millimeters. Dimensioning and tolerancing per ASME Y14.5M-1994.
B. This drawing is subject to change without notice.

4215053/A 12/12

IMPORTANT NOTICE AND DISCLAIMER

TI PROVIDES TECHNICAL AND RELIABILITY DATA (INCLUDING DATA SHEETS), DESIGN RESOURCES (INCLUDING REFERENCE DESIGNS), APPLICATION OR OTHER DESIGN ADVICE, WEB TOOLS, SAFETY INFORMATION, AND OTHER RESOURCES "AS IS" AND WITH ALL FAULTS, AND DISCLAIMS ALL WARRANTIES, EXPRESS AND IMPLIED, INCLUDING WITHOUT LIMITATION ANY IMPLIED WARRANTIES OF MERCHANTABILITY, FITNESS FOR A PARTICULAR PURPOSE OR NON-INFRINGEMENT OF THIRD PARTY INTELLECTUAL PROPERTY RIGHTS.

These resources are intended for skilled developers designing with TI products. You are solely responsible for (1) selecting the appropriate TI products for your application, (2) designing, validating and testing your application, and (3) ensuring your application meets applicable standards, and any other safety, security, regulatory or other requirements.

These resources are subject to change without notice. TI grants you permission to use these resources only for development of an application that uses the TI products described in the resource. Other reproduction and display of these resources is prohibited. No license is granted to any other TI intellectual property right or to any third party intellectual property right. TI disclaims responsibility for, and you will fully indemnify TI and its representatives against, any claims, damages, costs, losses, and liabilities arising out of your use of these resources.

TI's products are provided subject to [TI's Terms of Sale](#) or other applicable terms available either on ti.com or provided in conjunction with such TI products. TI's provision of these resources does not expand or otherwise alter TI's applicable warranties or warranty disclaimers for TI products.

TI objects to and rejects any additional or different terms you may have proposed.

Mailing Address: Texas Instruments, Post Office Box 655303, Dallas, Texas 75265
Copyright © 2021, Texas Instruments Incorporated