



AEC-Q200

This component was always RoHS compliant from the first date of manufacture.

- Low Loss L-Band SAW Filter
- 200 ohm Balanced Input and Output Ports
- Complies with Directive 2002/95/EC (RoHS)



SF2017E

**1220 MHz
SAW Filter**

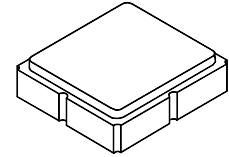

SM3030-8

Maximum Rating

Rating	Value	Units
Input Power Level	0	dBm
DC Voltage on any Non-ground Terminal	3	V
Operating Temperature Range	-40 to +85	°C
Storage Temperature Range in Tape and Reel	-40 to +85	°C
Suitable for Lead-free Soldering - Maximum Soldering Profile	260 °C for 30 s	

Electrical Characteristics

Characteristic	Sym	Notes	Min	Typ	Max	Units
Center Frequency	f_C			1220		MHz
Insertion Loss, 1216 to 1224 MHz	IL			3.4	5.3	dB
Amplitude Ripple, 1216 to 1224 MHz				0.6	1.8	dB _{p-p}
Attenuation, Referenced to 0 dB						
500 to 1129 MHz			50	57		dB
1129 to 1135 MHz			50	57		
1144 to 1152 MHz			46	57		
1132 MHz			50	57		
1148 MHz			48	57		
1176 MHz			50	56		
1184 MHz			46	55		
1290 to 2000 MHz			50	55		
Group Delay Ripple, 1216 to 1224 MHz				12		ns _{p-p}
Balanced Source Impedance				200		ohms
Balanced Load Impedance				200		ohms

Case Style	SM3030-8 3.0 x 3.0 mm Nominal Footprint					
Lid Symbolization (Y=year, WW=week, S=shift) dot=pin 1 indicator	898, YVWS					
Standard Reel Quantity	Reel Size 7 Inch					500 Pieces/Reel
	Reel Size 13 Inch					3000 Pieces/Reel

	Connection	Terminals
Port 1	Balanced Input	1,2
Port 2	Balanced Output	5,6
	Ground	All Others

Dot Indicates Pin 1

CAUTION: Electrostatic Sensitive Device. Observe precautions for handling.



NOTES:

1. The design, manufacturing process, and specifications of this device are subject to change.
2. US or International patents may apply.

Frequency Response Plots

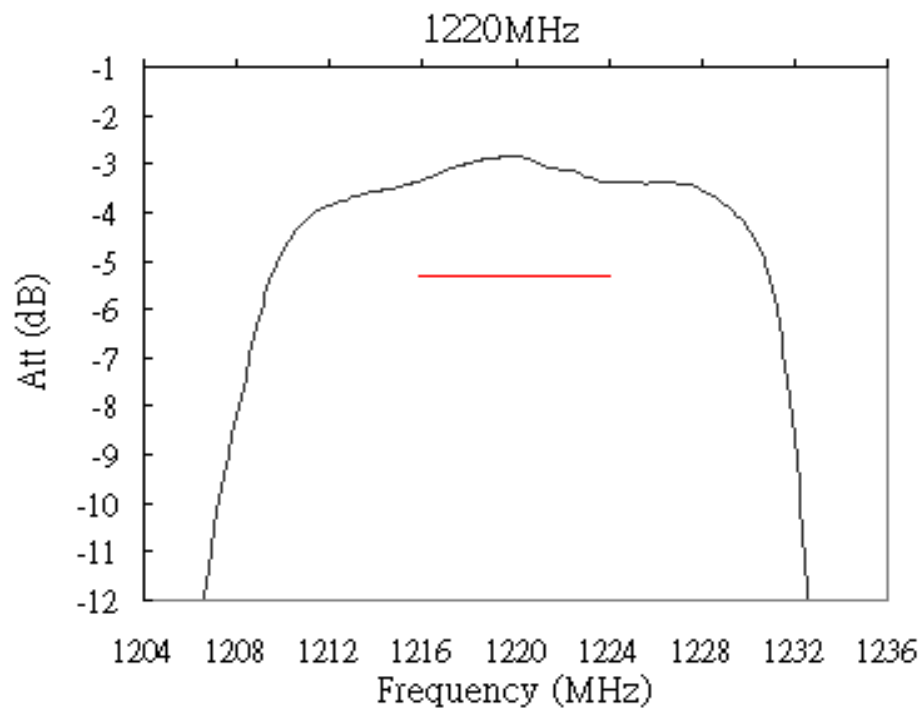
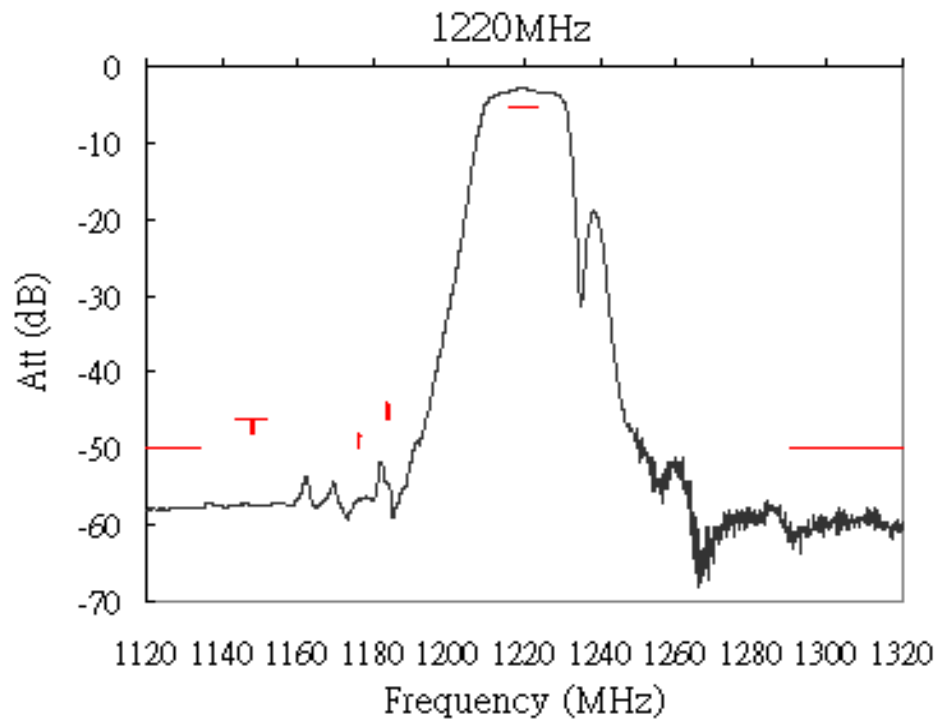

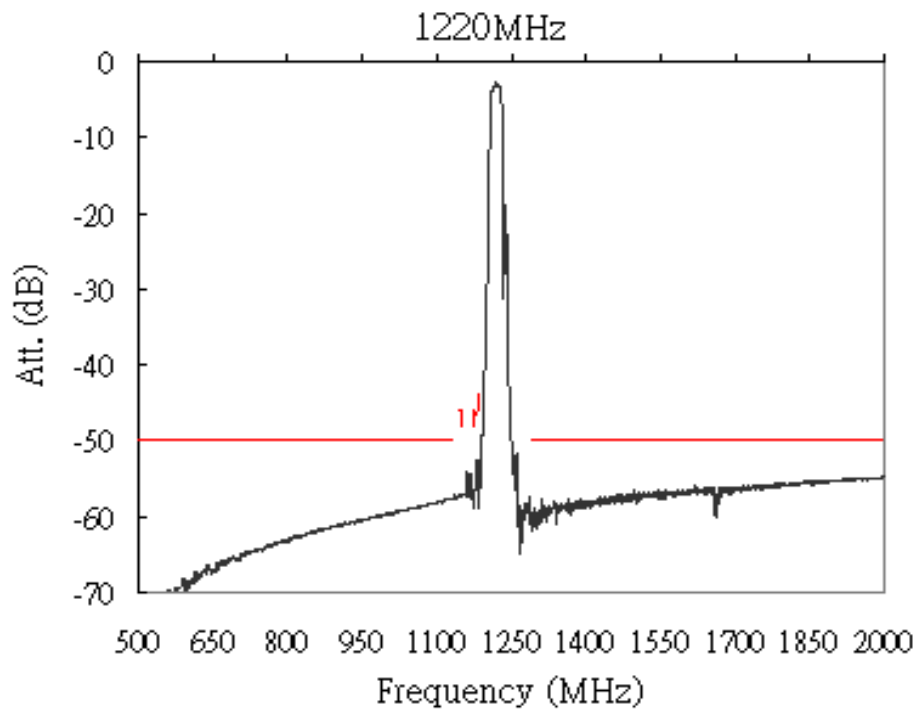

Matching Network Topology

SF2017E Test Circuit

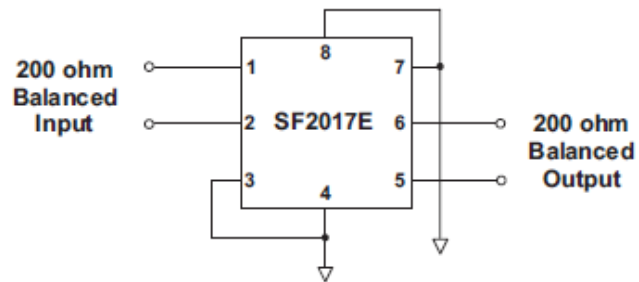

8-Terminal Ceramic Surface-Mount Case 3.0 X 3.0 mm Nominal Footprint

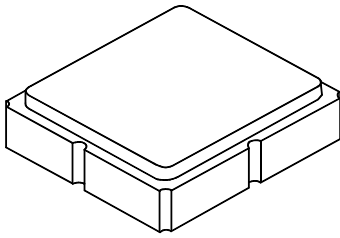

Case and PCB Footprint Dimensions

Dimension	mm			Inches		
	Min	Nom	Max	Min	Nom	Max
A	2.87	3.0	3.13	0.113	0.118	0.123
B	2.87	3.0	3.13	0.113	0.118	0.123
C	1.14	1.27	1.40	0.045	0.050	0.055
D	0.79	0.92	1.05	0.031	0.036	0.041
E	0.62	0.75	0.88	0.024	0.029	0.034
F	0.47	0.60	0.73	0.018	0.024	0.029
G	0.47	0.60	0.73	0.018	0.024	0.029
H	1.07	1.20	1.33	0.042	0.047	0.052
I		3.19			0.126	
J		0.81			0.032	
K		0.96			0.038	
L		0.81			0.032	
M		1.39			0.055	
N		0.23			0.009	
O		0.38			0.015	

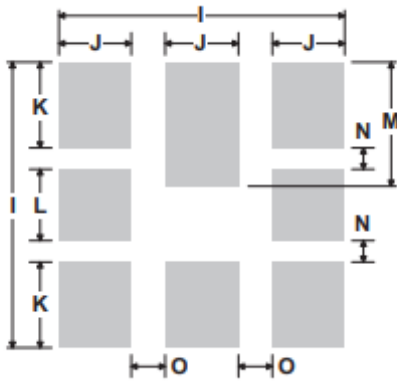

PCB Footprint Top View

Case Materials

Materials	
Solder Pad Plating	0.3 to 1.0 μm Gold over 1.27 to 8.89 μm Nickel
Lid Plating	2.0 to 3.0 μm Nickel
Body	Al_2O_3 Ceramic
	Pb Free

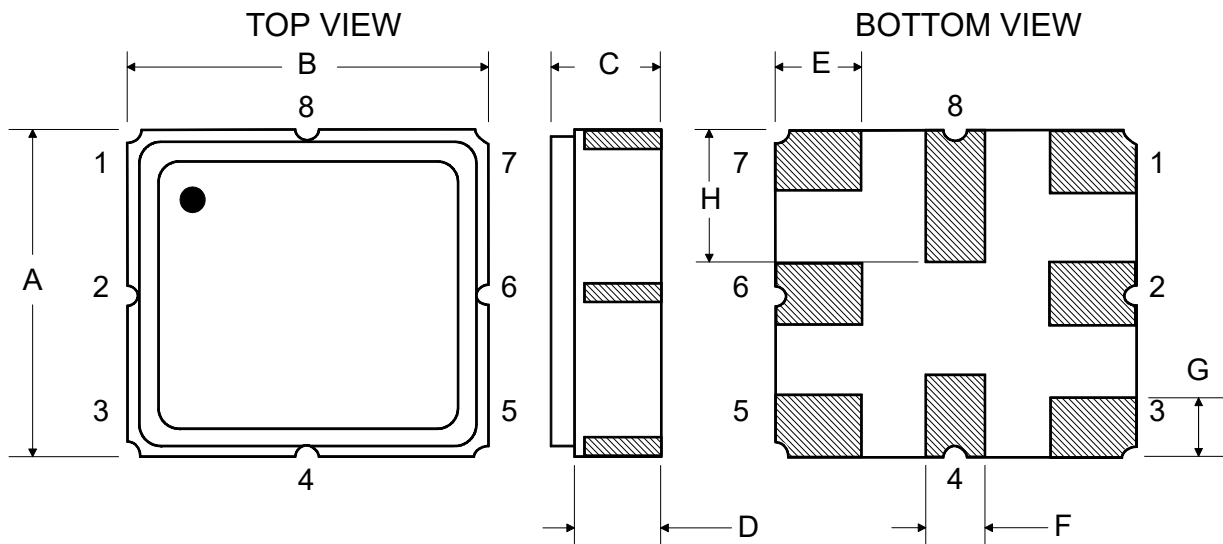

Tape and Reel Specifications

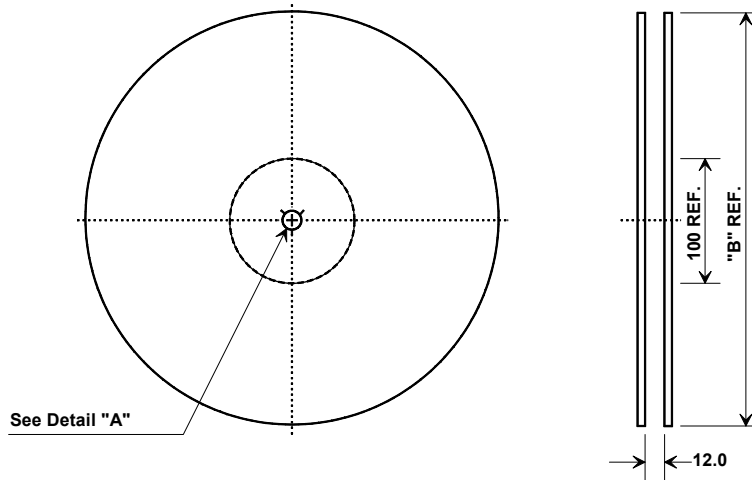

Tape and Reel Standard per ANSI/EIA-481

"B" Nominal Size		Quantity Per Reel
Inches	millimeters	
7	178	500
13	330	3000

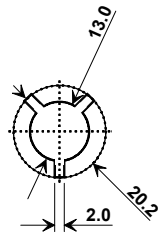

COMPONENT ORIENTATION and DIMENSIONS

Carrier Tape Dimensions	
Ao	3.35 mm
Bo	3.35 mm
Ko	1.4 mm
Pitch	8.0 mm
W	12.0 mm

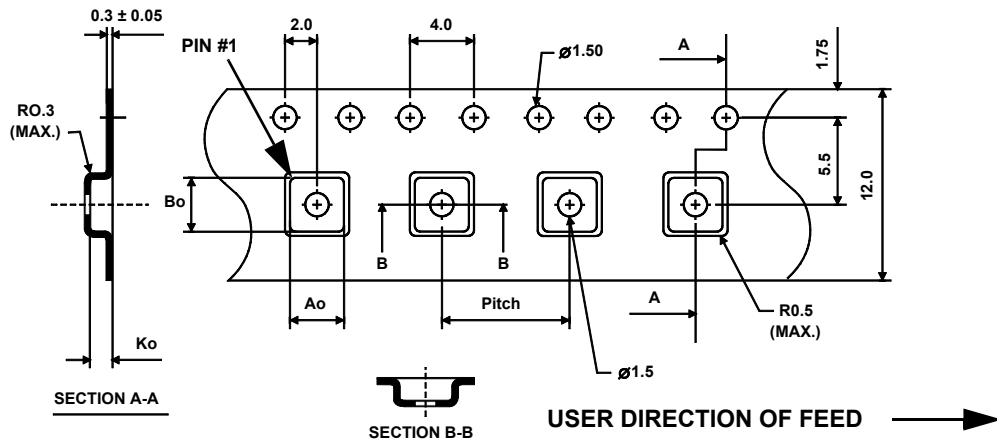

Recommended Reflow Profile

1. Preheating shall be fixed at 150~180°C for 60~90 seconds.
2. Ascending time to preheating temperature 150°C shall be 30 seconds min.
3. Heating shall be fixed at 220°C for 50~80 seconds and at 260°C +0/-5°C peak (10 seconds).
4. Time: 5 times maximum.

