

RIGHT ANGLE PLUG SOLDER TYPE

R161.152.107

CABLE .141

Series : N

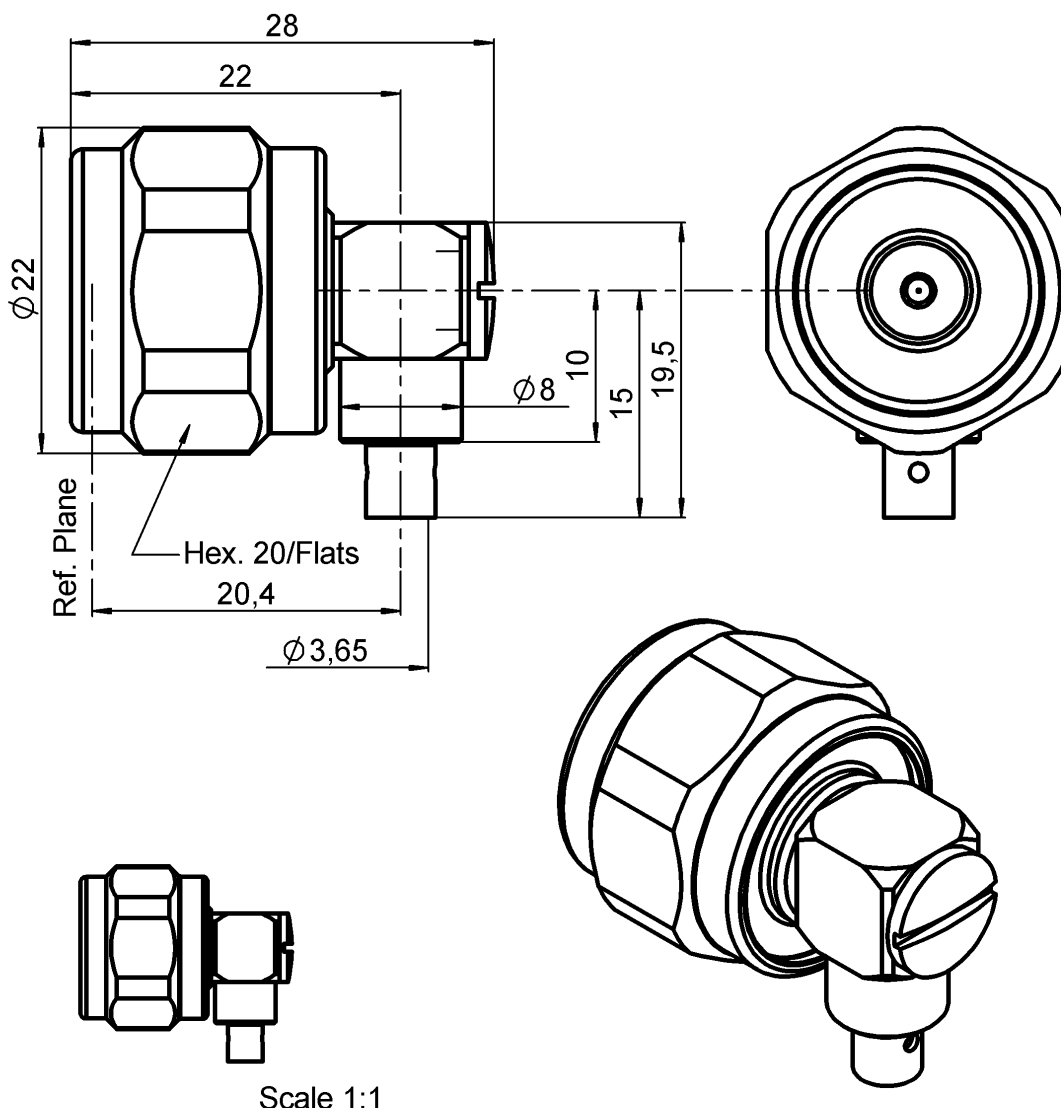

All dimensions are in mm.

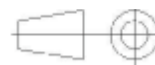

COMPONENTS	MATERIALS	PLATING (µm)
BODY	BRASS	BBR 2
CENTER CONTACT	BRASS	.GOLD 1.3 OVER NICKEL 2
OUTER CONTACT	BRASS	BBR 2
INSULATOR	PTFE	
GASKET	SILICONE RUBBER	
OTHERS PARTS	BRASS	BBR 2
-	-	-
-	-	-

Issue : 0750 D

In the effort to improve our products, we reserve the right to make changes judged to be necessary.



RIGHT ANGLE PLUG SOLDER TYPE

R161.152.107

CABLE .141

Series : N

PACKAGING

Standard	Unit	Other
50	'W' option	Contact us

SPECIFICATION

ELECTRICAL CHARACTERISTICS

Impedance	50	Ω
Frequency	0-11	GHz
VSWR	1.10* + 0,0000	x F(GHz) Maxi
Insertion loss	0.07	\sqrt{F} (GHz) dB Maxi
RF leakage	- (101)	- F(GHz)) dB Maxi
Voltage rating	335	Veff Maxi
Dielectric withstanding voltage	1000	Veff mini
Insulation resistance	5000	M Ω mini

CABLE ASSEMBLY

Stripping	a	b	c	d	e	f
mm	9,00	3,00	0,00	0,00	0,00	0,00

Assembly instruction :

Recommended cable(s)
 KS 2
 SUCOFORM 141
 HC80000-3
 BELN 1673A
 RG 402

Characteristics indicated on this data sheet are those that can be achieved with the highest performance cable. Intrinsic limitations of the cable may diminish the performance of the assembly

Cable retention

- pull off **500** N mini
 - torque **NA** N.cm

MECHANICAL CHARACTERISTICS

Center contact retention		
Axial force – Mating end	27	N mini
Axial force – Opposite end	27	N mini
Torque	NA	N.cm mini

TOOLING

Recommended torque		
Mating	170	N.cm
Panel nut	NA	N.cm
Clamp nut	NA	N.cm
A/F clamp nut	0,0000	mm

Part Number	Description	Hexagon
R282.740.030	SOLDERING MOUNTING	

Mating life	500	Cycles mini
Weight	30,7680	g

OTHER CHARACTERISTICS

*Between 0-2GHz

ENVIRONMENTAL

Operating temperature	-55/+105	$^{\circ}$ C
Hermetic seal	NA	Atm.cm3/s
Panel leakage	NA	

Issue : 0750 D

In the effort to improve our products, we reserve the right to make changes judged to be necessary.



RIGHT ANGLE PLUG SOLDER TYPE

R161.152.107

CABLE .141

Series : N

COMPONENT

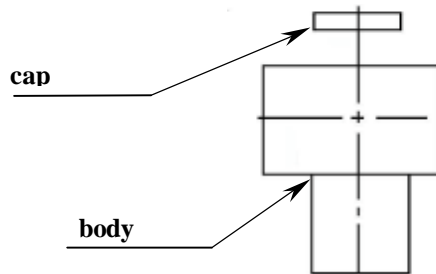

STRIPPING CABLES

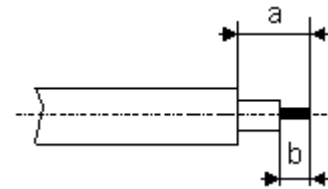

We recommend a thermal preconditioning cable

1

Strip the dielectric of the cable .
Clean the cable .
Temperature stoking do not exceed 250° max

2

Slide cable and connector onto the soldering jig.
Slide cable into connector until it bottoms against the body and tighten.
Solder the body onto the cable .

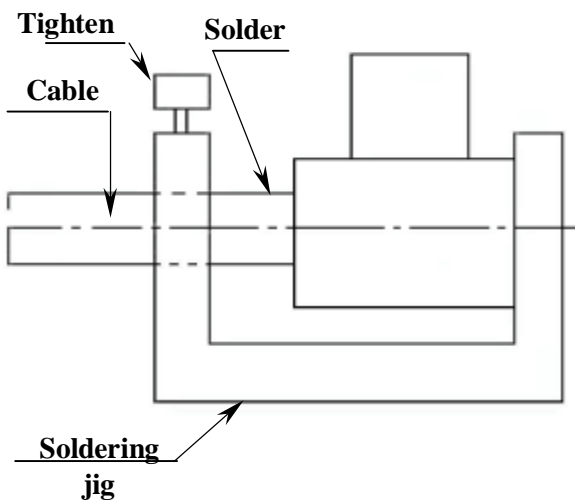

3

After cooling remove cable assembly from the jig .
Slide body into positioner until it bottoms against the positioner .
Slide cable assembly onto the jig .
Tighten and solder the contact.
After cooling remove cable assembly from the jig.

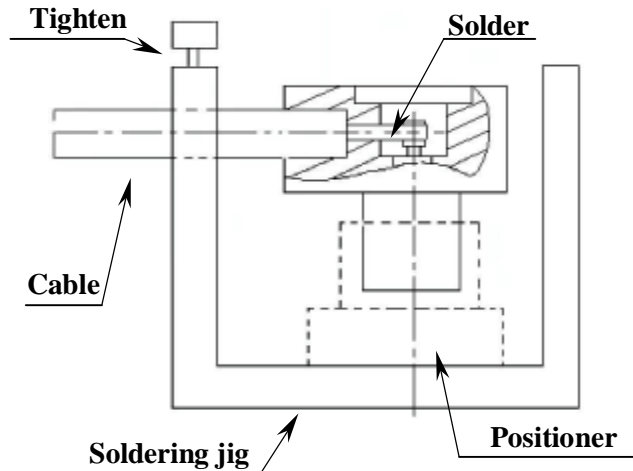

4

Screw the cap until it bottoms against the body .
(direction F)

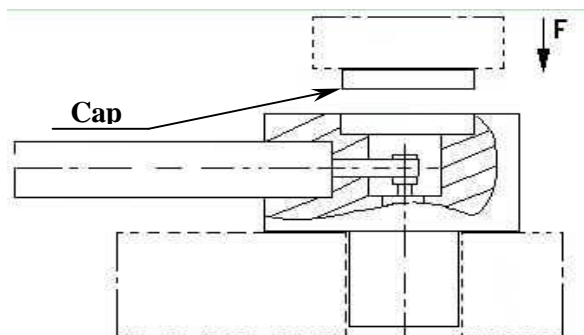

Issue : 0750 D

In the effort to improve our products, we reserve the right to make changes judged to be necessary.

