

2 x 20 Backlit LCD Display



- 2 Line by 20 Character LCD Display
- Membrane Keypad with Customizable Key Legend Insert
- 24 Programmable Keys
- 1 Serial RS232/422/485 Port

System	Capacity (screens)	500
	Audio	Internal audio transducer
I/O Ports	Serial	1 x RJ45 shielded RS-232/422/485
	Power	3 pins terminal block connector, DC power input
Display	Type	STN yellow green LCD; 5 x 7 dot matrix
	Size	2 line by 20 characters
	Viewing Angle (°)	35/40/35/35 (T, B, L, R)
	Backlight	LED
	Backlight Longevity (hrs.)	50,000
Keypad	Type	Flat panel membrane
	Material	Polyester
	Lifespan	3 million operations
	Programmable Keys	24 (up to 8 screen-dependent)
Electrical	Customizable Key Legend	Yes
	Input Voltage	12 ~ 30 VDC
	Input Power	2.18 W
	Input Current	91 mA @ 24 VDC
Mechanical	Enclosure	Aluminum
	Dimensions (W x H x D)	6 x 4 x 1.77 inches [152.4 x 101.6 x 45 mm]
	Weight	0.75 lbs [0.34 kg]
	Mounting	Panel mounting
Environmental	Operating Temperature	14 ~ 149°F (-10 ~ 65°C)
	Storage Temperature	-22 ~ 176°F (-30 ~ 80°C)
	Relative Humidity	5% ~ 95% (non-condensing)
	Rating	NEMA4X / IP65
	Certifications	CE / cULus (Class I, Division 2)
Notes	Specifications subject to change without notice. For panel cutout dimensions, please refer to dimensional drawing.	

Top View



Front View

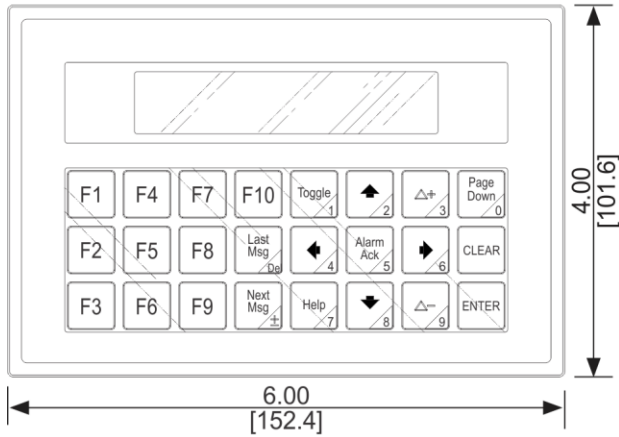

Side View

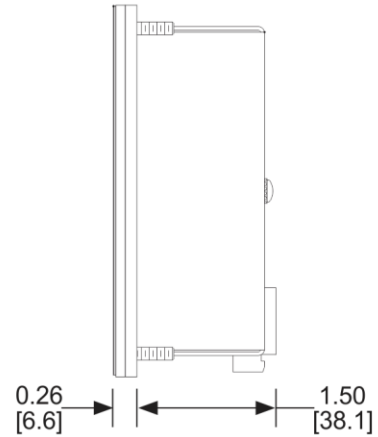

Rear View

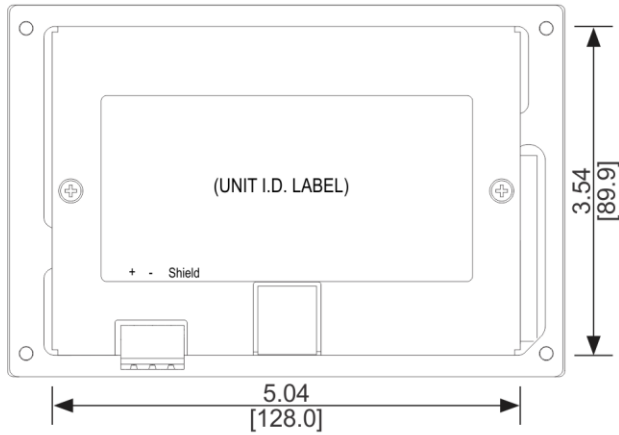

0.172 [4.4] DIA,
4 Holes

Cutout Dimensions

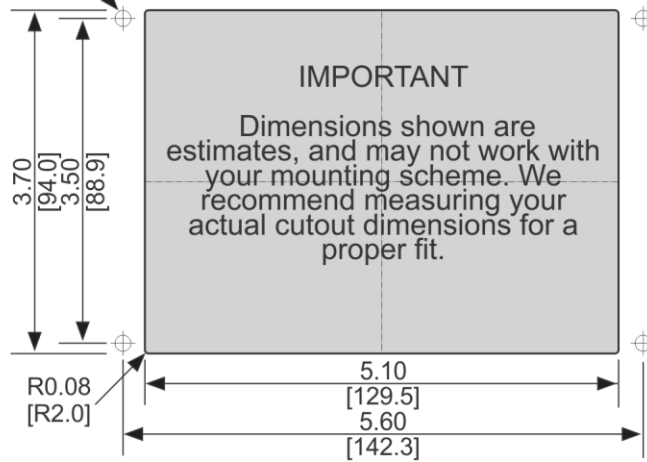

Bottom View

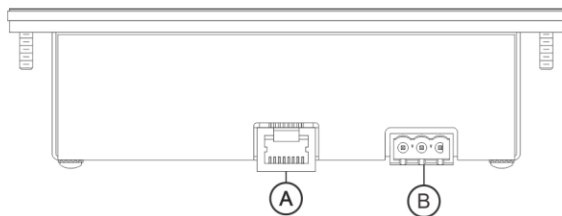

Dimensions are in inches [mm]

- (A) RJ-45 Serial COM Port
- (B) Power Connector