

AGRF Series

Radial Leaded

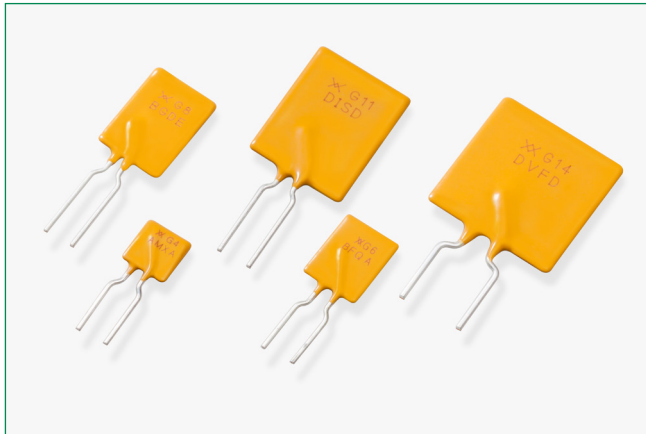

Description

The AGRF Series is a PPTC resettable device designed specifically for the automotive industry. It is a 16V lead-free, radial leaded resettable device that meets Littelfuse's Automotive qualification. This qualification is based on AEC-Q200: Stress Test Qualification for Passive Components.

Applications

- Motor and motor circuit protection including power door-locks, mirrors, lumbar pumps, seats, sunroofs and windows
- Electronic Control Unit (ECU) I/O protection
- Heating, Ventilation and Cooling (HVAC) motor and I/O protection
- Telematics, infotainment and navigations systems
- Liquid Crystal Display (LCD) back-light heaters
- Power and cigarette lighter outlets, plugs and adapter/chargers
- Powered networks and buses
- Air-flow detection and overcurrent protection in HVAC and cooling fan systems
- Stall detection in express window and sunroof circuits
- Resettable overcurrent protection for power distribution, electrical centers and junction boxes
- Wire downsizing
- Motor electromagnetic interference (EMI) suppression
- Electrostatic discharge (ESD) damage protection
- Load dump and other transient voltage protection

Additional Information



Resources



Accessories



Samples

Agency Approvals

Agency	Agency File Number
	E74889

Features & Benefits

- Overcurrent and overvoltage circuit protection devices
- Resettable and single-use overcurrent devices
- Wide range of form factor and termination methods
- Products meet applicable automotive industry standards
- Devices compatible with high-volume electronics assembly
- RoHS compliant, Lead-Free and Halogen-Free

Electrical Characteristics

Part Number	Ordering Part Number	$I_H(A)@$ (R_{1MAX})	$I_H(A)@$ (R_{nMAX})	I_T (A)	V_{MAX} (V_{DC})	I_{MAX} (A)	P_D Typ (W)	Max Time-to-trip (A) (s)		R_{MIN} (Ω)	R_{1MAX} (Ω)	R_{nMAX} (Ω)	Lead Size (mm ² / AWG)
AGRF – 16V													
AGRF400	RF3057-000	4.0	3.0	7.6	16	100	2.5	20.0	2.0	0.0186	0.0610	0.0850	0.52/20
AGRF500	RF3276-000	5.0	4.3	9.4	16	100	2.7	25.0	2.5	0.0140	0.0340	0.0480	0.52/20
AGRF600	RF3278-000	6.0	5.3	10.7	16	100	2.8	30.0	3.5	0.0095	0.0280	0.0320	0.52/20
AGRF700	RF3280-000	7.0	6.5	13.2	16	100	3.0	35.0	4.0	0.0066	0.0200	0.0220	0.52/20
AGRF800	RF3282-000	8.0	7.6	15.0	16	100	3.2	40.0	5.5	0.0049	0.0175	0.0181	0.52/20
AGRF900	RF3191-000	9.0	8.6	16.5	16	100	3.4	45.0	6.0	0.0041	0.0135	0.0140	0.52/20
AGRF1000	RF3285-000	10.0	9.6	18.5	16	100	3.6	50.0	7.0	0.0034	0.0102	0.0106	0.52/20
AGRF1100	RF3287-000	11.0	10.5	20.3	16	100	3.7	55.0	7.5	0.0033	0.0089	0.0093	0.52/20
AGRF1200	RF3290-000	12.0	11.5	22.1	16	100	4.2	60.0	8.0	0.0030	0.0086	0.0091	0.82/18
AGRF1400	RF3292-000	14.0	13.0	27.3	16	100	4.6	70.0	9.0	0.0022	0.0064	0.0067	0.82/18

Notes:

- I_H : Hold current: maximum current device will pass without interruption in 25°C, unless otherwise specified.
- I_T : Trip current: minimum current that will switch the device from low-resistance to high-resistance in 25°C still air, unless otherwise specified.
- V_{MAX} : Maximum voltage device can withstand without damage at rated current.
- I_{MAX} : Maximum fault current device can withstand without damage at rated voltage.
- P_D : Power dissipated from device when in the tripped state in 25°C still air, unless otherwise specified.

- R_{MIN} : Minimum resistance of device as supplied at 25°C, unless otherwise specified.
- R_{1MAX} : Maximum resistance of device when measured one hour post trip at 25°C unless otherwise specified.
- R_{nMAX} : Maximum functional resistance of device after being subjected to the stresses described in PS400 at 25°C, unless otherwise specified.
- R_{sMIN} : Minimum functional resistance of device after being subjected to the stresses described in PS400 at 25°C, unless otherwise specified.
- * Electrical characteristics determined at 25°C.

AGRF Series

Radial Leaded

Temperature Derating

	Maximum Ambient Temperature									
	-40°C	-20°C	0°C	20°C	25°C	40°C	50°C	60°C	70°C	85°C
Hold Current (A)										
AGRF – 16V										
AGRF400	5.9	5.3	4.8	4.1	4.0	3.5	3.2	2.8	2.5	1.9
AGRF500	7.3	6.6	6.0	5.2	5.0	4.4	4.0	3.6	3.1	2.4
AGRF600	8.8	8.0	7.2	6.2	6.0	5.2	4.8	4.2	3.8	2.8
AGRF700	10.3	9.3	8.4	7.3	7.0	6.2	5.6	5.0	4.4	3.3
AGRF800	11.7	10.7	9.6	8.3	8.0	6.9	6.4	5.6	5.1	3.7
AGRF900	13.2	11.9	10.7	9.4	9.0	7.9	7.2	6.4	5.6	4.2
AGRF1000	14.7	13.3	12.0	10.3	10.0	8.7	8.0	7.0	6.3	4.7
AGRF1100	16.1	14.6	13.1	11.5	11.0	9.7	8.8	7.8	6.9	5.2
AGRF1200	17.6	16.0	14.4	12.4	12.0	10.4	9.6	8.4	7.6	5.6
AGRF1400	20.5	18.7	16.8	14.5	14.0	12.1	11.2	9.8	8.9	6.5

Temperature Derating Curve

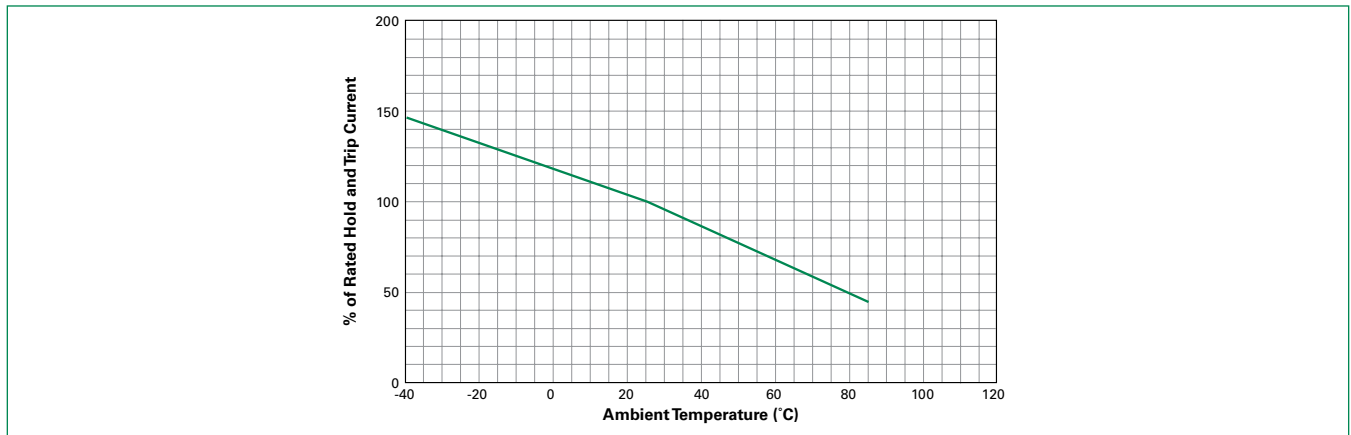

Part Ordering Number System

AGRF 800 -2

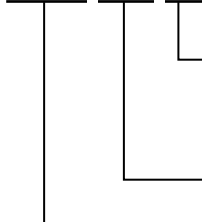

Packaging Option
 (Blank) = Bulk
 2 = Tape and Reel Packaging
 AP = Ammo Pack

Hold Current Indicator

Product Series
 An "F" at the End of the Series Indicates Pb-free Version of Product

AGRF Series

Radial Leaded

Typical Time-to-Trip Curves at 25°C

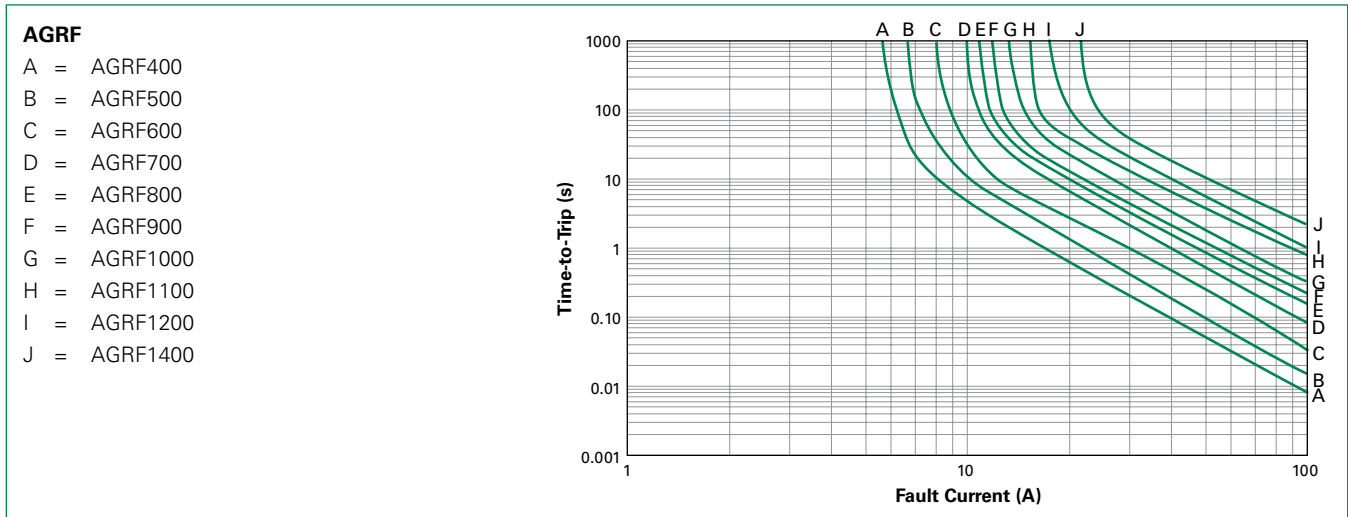

Physical Specifications

Lead Material	AGRF400 to AGRF1100 : Tin-plated Copper, 0.52mm ² (20AWG) ø 0.8 mm/0.032in AGRF1200 to AGRF1400 : Tin-plated Copper, 0.82mm ² (18AWG) ø 1.0mm/0.040in
Soldering Characteristics	Solderability per ANSI/J-STD-002 Category 3
Solder Heat Withstand	AGRF400: Per IEC 60068-2-20, Test Tb, Method 1; Can withstand 5s at 260° C ± 5° C AGRF500-AGRF1400: Per IEC 60068-2-20, Test Tb, Method 1; Can withstand 10s at 260° C ± 5° C
Insulating Material	Cured, Flame-retardant Epoxy Polymer; Meets UL 94V-0
Operation Temperature	-40°C~85°C

Note: See PS400 for other physical characteristics. Devices are not designed to be placed through a reflow process.

Environmental Specifications

Test	Conditions	Resistance Change
Passive Aging	70°C, 1000 hrs	±5%
	85°C, 1000 hrs	±5%
Humidity Aging	85°C, 85% R.H., 1000 hrs	±5%
Thermal Shock	85°C, -40°C 10 times	±5%
Solvent Resistance	MIL-STD-202, Method 215	No change

Note: See PS400 for other environmental specifications.

Moisture Resistance Level	Level 1, J-STD-020
Storage Conditions	40°C max, 70% RH max; devices should remain in original sealed bags prior to use. Devices may not meet specified values if these storage conditions are exceeded.

AGRF Series

Radial Leaded

Dimension Figures

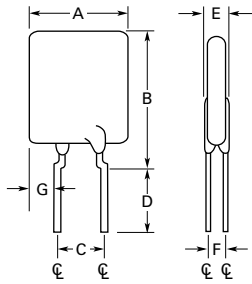

Figure 1

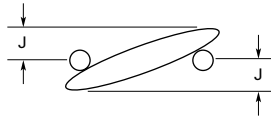

Figure 2

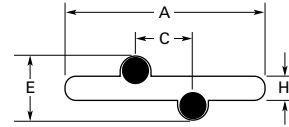

Figure 3

Dimensions

Part Number	Dimensions in Millimeters (Inches)																Figure
	A		B		C		D		E		F		G		H	J	
	Min	Max	Min	Max	Min	Max	Min	Max	Min	Max	Min	Max	Min	Max	Typ	Typ	
AGRF – 16V																	
AGRF400	—	8.9 (0.350)	—	14.1 (0.56)	4.3 (0.17)	5.8 (0.20)	7.6 (0.3)	—	—	3.0 (0.12)	1.2 (0.15)	—	—	3.10 (0.120)	1.24 (0.049)	1.4 (0.06)	1,2,3
AGRF500	—	10.4 (0.410)	—	15.6 (0.61)	4.3 (0.17)	5.8 (0.20)	7.6 (0.3)	—	—	3.0 (0.12)	1.2 (0.05)	—	—	3.94 (0.155)	1.24 (0.049)	1.6 (0.06)	1,2,3
AGRF600	—	10.7 (0.420)	—	18.4 (0.73)	4.3 (0.17)	5.8 (0.20)	7.6 (0.3)	—	—	3.0 (0.12)	1.2 (0.05)	—	—	4.07 (0.160)	1.24 (0.049)	1.6 (0.06)	1,2,3
AGRF700	—	11.2 (0.440)	—	21.0 (0.73)	4.3 (0.17)	5.8 (0.20)	7.6 (0.3)	—	—	3.0 (0.12)	1.2 (0.05)	—	—	4.49 (0.177)	1.24 (0.049)	1.7 (0.07)	1,2,3
AGRF800	—	12.7 (0.500)	—	22.2 (0.88)	4.3 (0.17)	5.8 (0.20)	7.6 (0.3)	—	—	3.0 (0.12)	1.2 (0.05)	—	—	5.08 (0.200)	1.24 (0.049)	1.8 (0.07)	1,2,3
AGRF900	—	14.0 (0.550)	—	23.0 (0.91)	4.3 (0.17)	5.8 (0.20)	7.6 (0.3)	—	—	3.0 (0.12)	1.2 (0.05)	—	—	5.69 (0.224)	1.24 (0.049)	2.0 (0.08)	1,2,3
AGRF1000	—	16.51 (0.650)	—	25.7 (1.01)	4.3 (0.17)	5.8 (0.20)	7.6 (0.3)	—	—	3.0 (0.12)	1.2 (0.05)	—	—	6.96 (0.274)	1.24 (0.049)	2.0 (0.08)	1,2,3
AGRF1100	—	17.5 (0.690)	—	26.5 (1.04)	4.3 (0.17)	5.8 (0.20)	7.6 (0.3)	—	—	3.0 (0.12)	1.2 (0.05)	—	—	7.47 (0.294)	1.24 (0.049)	2.4 (0.09)	1,2,3
AGRF1200	—	17.5 (0.690)	—	28.8 (1.14)	9.4 (0.37)	10.9 (0.43)	7.6 (0.3)	—	—	3.5 (0.14)	1.4 (0.06)	—	—	4.83 (0.190)	1.45 (0.057)	1.5 (0.06)	1,2,3
AGRF1400	—	23.5 (0.925)	—	28.7 (1.13)	9.4 (0.37)	10.9 (0.43)	7.6 (0.3)	—	—	3.5 (0.14)	1.4 (0.06)	—	—	7.82 (0.308)	1.45 (0.057)	1.9 (0.07)	1,2,3

AGRF Series

Radial Leaded

Packaging and Marking Information

Part Number	Bag Quantity	Tape and Reel Quantity	Ammo Pack Quantity	Standard Package Quantity	Part Marking	Agency Recognition
AGRF – 16V						
AGRF400	500	—	—	10,000	G4	UL
AGRF400-2	—	2,500	—	12,500	G4	UL
AGRF400-AP	—	—	2,000	10,000	G4	UL
AGRF500	500	—	—	10,000	G5	UL
AGRF500-2	—	2,000	—	10,000	G5	UL
AGRF500-AP	—	—	2,000	10,000	G5	UL
AGRF600	500	—	—	10,000	G6	UL
AGRF600-2	—	2,000	—	10,000	G6	UL
AGRF600-AP	—	—	2,000	10,000	G6	UL
AGRF700	500	—	—	10,000	G7	UL
AGRF700-2	—	1,500	—	7,500	G7	UL
AGRF700-AP	—	—	1,500	7,500	G7	UL
AGRF800	500	—	—	10,000	G8	UL
AGRF800-2	—	1,500	—	7,500	G8	UL
AGRF800-AP	—	—	1,500	7,500	G8	UL
AGRF900	500	—	—	10,000	G9	UL
AGRF900-2	—	1,000	—	5,000	G9	UL
AGRF900-AP	—	—	1,000	5,000	G9	UL
AGRF1000	250	—	—	5,000	G10	UL
AGRF1000-2	—	1,000	—	5,000	G10	UL
AGRF1000-AP	—	—	1,000	5,000	G10	UL
AGRF1100	250	—	—	5,000	G11	UL
AGRF1100-2	—	1,000	—	5,000	G11	UL
AGRF1100-AP	—	—	1,000	5,000	G11	UL
AGRF1200	250	—	—	5,000	G12	UL
AGRF1200-2	—	1,000	—	5,000	G12	UL
AGRF1200-AP	—	—	1,000	5,000	G12	UL
AGRF1400	250	—	—	5,000	G14	UL
AGRF1400-2	—	1,000	—	5,000	G14	UL
AGRF1400-AP	—	—	1,000	5,000	G14	UL

Note: These devices are intended for use in automotive applications.

AGRF Series

Radial Ledged

Tape and Reel Specifications

Description	EIA Mark	Dimension (mm)	Tolerance
Carrier Tape Width	W	18.0	-0.5/+1.0
Hold Down Tape Width	W ₄	11.0	Minimum
Top Distance between Tape Edges	W ₆	3.0	Maximum
Sprocket Hole Position	W ₅	9.0	-0.5/+0.75
Sprocket Hole Diameter	D ₀	4.0	±0.2
Abscissa to Plane (Kinked Lead) (AGRF400 to AGRF1400)	H ₀	16.0	±0.5
Abscissa to Top (AGRF400 to AGRF600)	H ₁	32.2	Maximum
Abscissa to Top (AGRF700 to AGRF1400)	H ₁	45.0	Maximum
Overall Width with Lead Protrusion (AGRF400 to AGRF600)	C ₁	43.2	Maximum
Overall Width with Lead Protrusion (AGRF700 to AGRF1400)	C ₁	55.0	Maximum
Overall Width without Lead Protrusion (AGRF400 to AGRF600)	C ₂	42.5	Maximum
Overall Width without Lead Protrusion (AGRF700 to AGRF1400)	C ₂	54.0	Maximum
Lead Protrusion	L ₁	1.0	Maximum
Protrusion of Cut-out	L	11.0	Maximum
Protrusion Beyond Hold-Down Tape	l ₂	Not specified	—
Sprocket Hole Pitch	P ₀	12.7	± 0.3
Device Pitch (AGRF400 to AGRF700)	—	12.7	± 0.3
Device Pitch (AGRF800 to AGRF1400)	—	25.4	± 0.6
Pitch Tolerance	—	20 consec.	± 0.1
Tape Thickness	t	0.9	Maximum
Overall Tape and Lead Thickness (AGRF400 to AGRF1100)	t ₁	2.0	Maximum
Overall Tape and Lead Thickness (AGRF1200 to AGRF1400)	t ₁	2.3	Maximum
Splice Sprocket Hole Alignment	—	0	± 0.3
Body Lateral Deviation	Δh	0	± 1.0
Body Tape Plane Deviation	Δp	0	± 1.3
Ordinate to Adjacent Component Lead (AGRF400 to AGRF1100)	P ₁	3.81	± 0.7
Ordinate to Adjacent Component Lead (AGRF1200 to AGRF1400)	P ₁	7.62	± 0.7
Lead Spacing (AGRF400 to AGRF1100)	F	5.05	± 0.75
Lead Spacing (AGRF1200 to AGRF1400)	F	10.15	± 0.75
Reel Width (AGRF400 to AGRF600)	w ₂	56.0	Maximum
Reel Width (AGRF700 to AGRF1400)	w ₂	63.5	Maximum
Reel Diameter	A	370.0	Maximum
Arbor Hold Diameter	c	26.0	±12.0
Core Diameter*	n	91.0	Maximum
Box	—	64/372/362	Maximum
Consecutive Missing Places	—	None	—
Empty Places per Reel	—	0.1%	Maximum

*Differs from EIA specification.

AGRF Series

Radial Leaded

Tape and Reel Diagrams

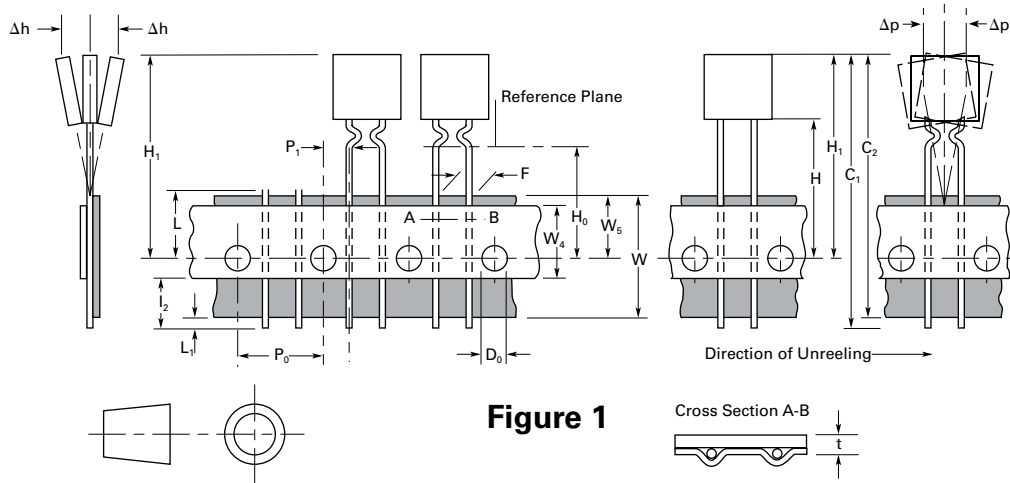

Figure 1

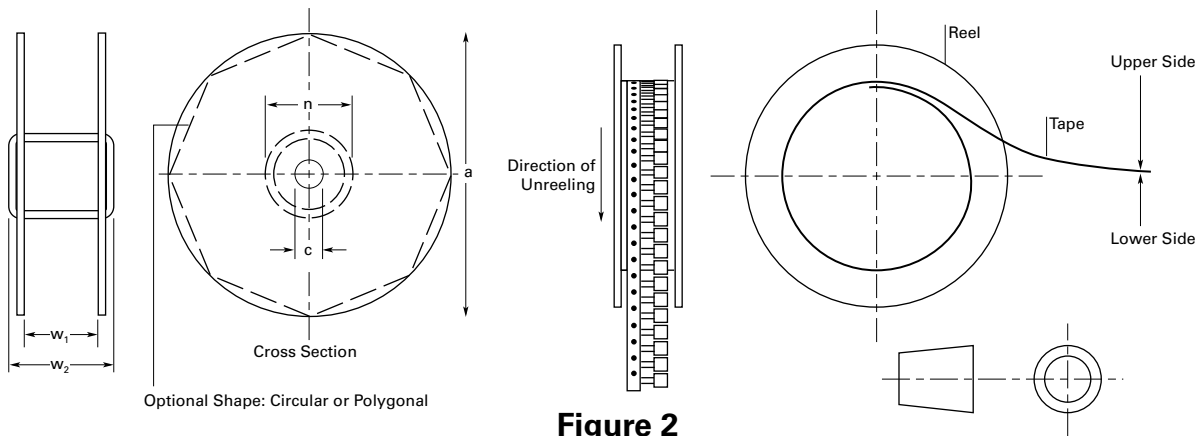

Figure 2

AGRF devices are available in tape and reel packaging per EIA468-B/IEC286-2 and EIA 481-2 standards. See Figures 1 and 2 for details.

Warning

- Users should independently evaluate the suitability of and test each product selected for their own application.
- Operation beyond the maximum ratings or improper use may result in device damage and possible electrical arcing and flame.
- These devices are intended for protection against damage caused by occasional overcurrent or overtemperature fault conditions and should not be used when repeated fault conditions or prolonged trip events are anticipated.
- Contamination of the PPTC material with certain silicone-based oils or some aggressive solvents can adversely impact the performance of the devices.
- Device performance can be impacted negatively if devices are handled in a manner inconsistent with recommended electronic, thermal, and mechanical procedures for electronic components.
- PPTC devices are not recommended for installation in applications where the device is constrained such that its PTC properties are inhibited, for example in rigid potting materials or in rigid housings, which lack adequate clearance to accommodate device expansion.
- Operation in circuits with a large inductance can generate a circuit voltage ($L di/dt$) above the rated voltage of the device.

Disclaimer Notice - Information furnished is believed to be accurate and reliable. However, users should independently evaluate the suitability of and test each product selected for their own applications. Littelfuse products are not designed for, and may not be used in, all applications. Read complete Disclaimer Notice at www.littelfuse.com/disclaimer-electronics.